

Universal Controller

SCX10

STARTUP MANUAL



Thank you for purchasing an Oriental Motor product.



The **SCX10** has been designed to be easy to use, and contains several unique functions.

This startup manual should help you to get to know the product quickly. Please read the separately supplied operating manual for more detailed information.

- It will be necessary to connect the **SCX10** to a computer for initial setup and test operation. Provide a computer and a commercially available USB 2.0 cable (mini-B type).
- The **ESMC** controller must be set to the driver mode when combining with the **SCX10**. The **ESMC** controller is represented as "driver" in this startup manual.

1 Safety Precautions

The precautions described below are intended to prevent danger or injury to the user and other personnel through safe, correct use of the product. Use the product only after carefully reading and fully understanding these instructions.

 Warning	Handling the product without observing the instructions that accompany a "Warning" symbol may result in serious injury or death.
 Caution	Handling the product without observing the instructions that accompany a "Caution" symbol may result in injury or property damage.
Note	The items under this heading contain important handling instructions that the user should observe to ensure safe use of the product.
 Memo	This contains information relative to the description provided in the main text.

Warning

Caution

General

- Do not use the product in explosive or corrosive environments, in the presence of flammable gases, locations subjected to splashing water, or near combustibles. Doing so may result in fire or injury.
- Assign qualified personnel the task of installing, wiring, operating/controlling, inspecting and troubleshooting the product. Failure to do so may result in fire or injury.
- Do not transport, install the product, perform connections or inspections when the power is on. Always turn the power off before carrying out these operations. Failure to do so may result in electric shock.
- When the device's protective function is triggered, first remove the cause and then clear the protective function. Continuing the operation without determining the cause of the problem may cause malfunction of the device, leading to injury or damage to equipment.

Installation

- Install the device in an enclosure in order to prevent injury.

Connection

- Keep the device's input-power voltage within the specified range to avoid fire.
- For the device's power supply use a DC power supply with reinforced insulation on its primary and secondary sides. Failure to do so may result in electric shock.
- Connect the cables securely according to the wiring diagram in order to prevent fire.

Operation

- Turn off the device power in the event of a power failure, or the motor may suddenly start when the power is restored and may cause injury or damage to equipment.

Repair, Disassembly and Modification

- Do not disassemble or modify the device. This may cause injury. Refer all such internal inspections and repairs to the branch or sales office from which you purchased the product.

General

- Do not use the device beyond its specifications, or injury or damage to equipment may result.

Transportation

- Do not hold the device cable. This may cause damage or injury.

Installation

- Keep the area around the device free of combustible materials in order to prevent fire or skin burn(s).

Connection

- When grounding the positive terminal of the power supply, do not connect any equipment (PC, etc.) whose negative terminal is grounded. Doing so may cause the driver and PC to short, damaging both.

Operation

- To avoid injury, remain alert during operation so that the device can be stopped immediately in an emergency.
- Before supplying power to the device, turn all start inputs to the device to "OFF." Otherwise, the device may start suddenly and cause injury or damage to equipment.
- When an abnormality is noted, stop the operation immediately, or fire or injury may occur.

Disposal

- When disposing of the device, treat it as ordinary industrial waste.

2 List of Items

- Universal Controller (**SCX10**) 1 unit
- CD-ROM 1 pc.
(**Immediate Motion Creator for CM/SCX Series** (utility software), Startup manual, Operating manual, CANopen EDS file, USB driver, .NET Framework 2.0)
- Connector set 1 set (packed in a bag)
 - RS-232C connector (3 pins): 1
 - CANopen connector (4 pins): 1
 - Power connector (3 pins): 1
- Encoder connector housing/contact (8 pins) 1 set (packed in a bag)
- Startup manual (This manual) 1 copy

3 Preparation

3.1 Connection and Switch Setting

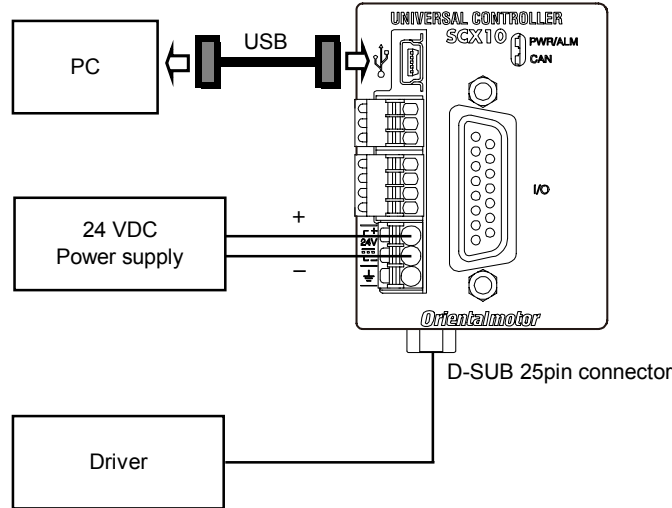

■ For all drivers except AR (LSD)/NX Series

Memo When the LSD driver is used, refer to the instructions indicated as the "AR Series" in this startup manual.

1. Set the driver pulse input mode to 1 pulse mode.
See the driver manual for information on how to set.
2. Connect Pulse/Direction signals to the driver connector

Pin assignment for D-SUB 25 pin connector

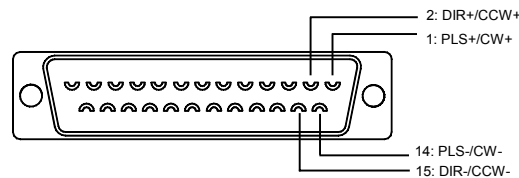

* See the driver manual for pulse input circuit and pin assignment on the driver.
The following example shows photo-coupler pulse input type drivers. (1-pulse mode)

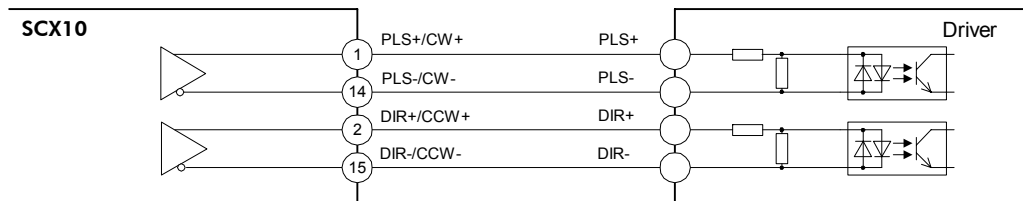

Memo The 5/24 V and SOURCE/SINK switch settings are not required for test operation.
..... After the test operation, turn the power off, and set those switches according to the Operating Manual.

3. Connect the 24 VDC power supply
Strip the cable insulation by 10mm. Push down the spring (orange) of the connector with the flat-tip screwdriver to open a terminal point, and insert the cable.

■ For AR (LSD)/NX Series driver only

1. Set the driver pulse input mode to 1 pulse mode.
See the driver user manual about how to set.
2. Set the driver interface voltage switch to 5 V
* The power must be off while setting.
3. Set the driver interface logic switch as you desire
* Connections differ according to the switch settings as below.
* The power must be off while setting.
4. Connect Pulse/Direction and CON signals

Pin assignment for D-SUB 25 pin connector

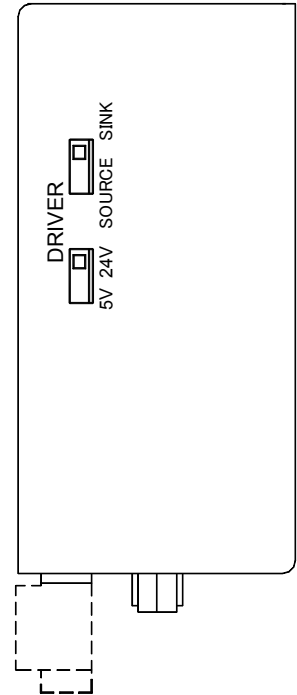
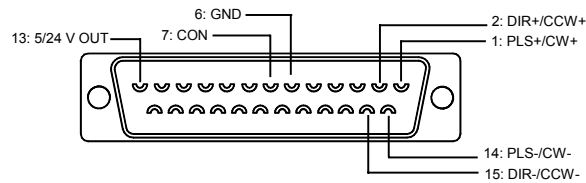

- Pulse (PLS)/Direction (DIR) signals

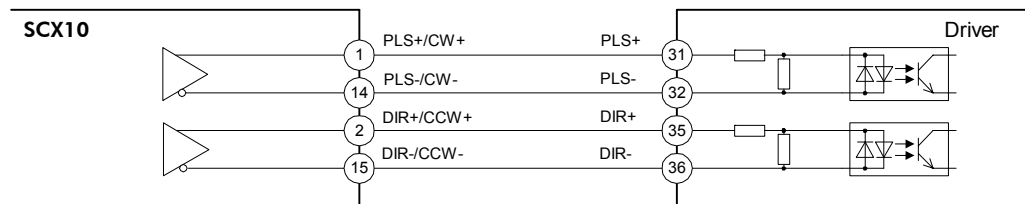

- Current ON (CON) signal

a. Sink Logic

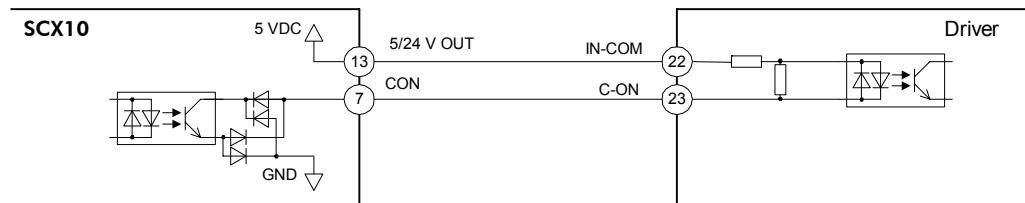

b. Source Logic

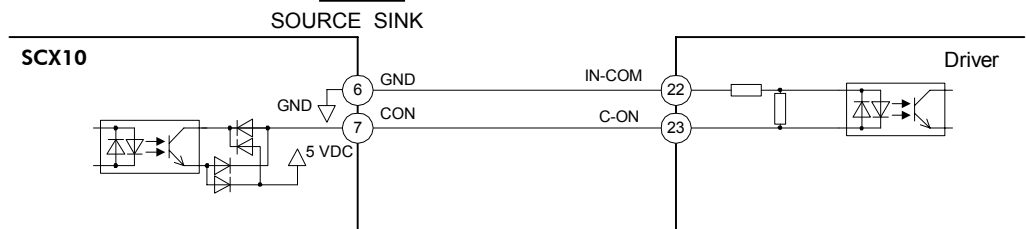

5. Connect the 24 VDC Power supply
Strip the cable insulation by 10mm. Push down the spring (orange) of the connector with the flat-tip screwdriver to open a terminal point, and insert the cable.

3.2 Preparation of Computer

Install the provided USB driver and utility software to your personal computer in order to execute a test operation or make initial settings.

Memo : When using RS-232C, skip the installation of the USB driver and go to "2. Installation of Utility Software **Immediate Motion Creator for the CM/SCX Series (IMC)**."

1. Installing the USB Driver (Other than Windows 8)

Insert the supplied CD-ROM into the CD-ROM drive of the computer, power on the **SCX10** and connect to a USB port using a USB 2.0 cable (mini-B type). You will then be asked to install the USB driver. See the procedure according to the type of Windows as follows.

* In the case of Windows 8, a little while after **SCX10** is powered on and connected to a USB port using a mini-B cable, USB driver is installed automatically.

Memo : Prepare a commercially available USB 2.0 cables (mini-B type). A cable with ferrite cores that has the effect of exogenous noise suppression is recommended.

Windows 7:

1. Open "Devices and Printers " in the Control Panel.
2. Right click on "FT232R USB UART" and select "Update Driver Software."
3. Select "Browse my computer for driver software."
4. Click "Browse" and select the applicable CD-ROM drive, check the box next to "Include subfolders" and click "Next."
5. After successful installation, click "Close."
6. Go back to the Device Manager, right click on "USB Serial Port" and select "Update Driver Software." Repeat same procedure as the above FT232R USB UART installation.

Windows Vista:

1. The installation of the FT232R USB UART is asked by Windows when the **SCX10** is connected. Select "Locate and install driver software," and click "Next." After successful installation, click "Close."
2. The installation of the USB Serial Port is then asked for by Windows.
3. Click "Next." After successful installation, click "Close."

Windows XP:

1. The installation of the FT232R USB UART is asked for by Windows when the **SCX10** is connected. Select "Install the software automatically," and click "Next." After successful installation, click "Finish."
2. The installation of the USB Serial Port is then asked for by Windows. Select "Install the software automatically," and click "Next."
3. After successful installation, click "Finish."

2. Installation of Utility Software **Immediate Motion Creator for the CM/SCX Series (IMC)**

Insert the supplied CD-ROM into your CD-ROM drive. Open the Explorer, select the applicable CD-ROM drive, open the IMC folder, double click on "setup.exe" and follow the on screen instructions.

* **IMC** runs on the Microsoft .NET Framework 2.0-3.5 and they are not automatically installed with Windows 8 and Windows XP. Unless you have separately installed them, install them as instructed below. (The .NET Framework 3.5 is normally installed with Windows 7 and the .NET Framework 3.0 is normally installed with Windows Vista.) Visit the Microsoft .NET Framework website if detailed information is required.

Windows 8: When you first launch the **IMC** after it is installed, the message prompting you to install the .NET Framework 3.5 is appeared. Install it by following the instructions appeared. (An Internet connection is required.)

Windows XP: Install the .NET Framework 2.0 software that is on the supplied CD-ROM, under the DotNet_Framework2_0 folder.

System Requirements for the **IMC**

- Windows 8, Windows 7, Windows Vista, Windows XP SP2 or later
- .NET Framework 2.0 - 3.5
- SVGA monitor 800 x 600 or greater
- USB or RS-232C port
- CD-ROM drive

Note

After Installation, click "Help" - "Check New Version" on the pull down menu with the Internet connection. If a newer version of this software is available, continue to the download and update actions.

Memo : When updating the installed version of the **IMC**, do so when the existing **IMC** is not running.

4 Setting the User Unit

In the **SCX10**, the actual motion distance of the user application, such as "mm," "inch," "revolution" and "degree" is used, instead of the pulse unit that is commonly used in pulse generators and motor controllers. This is called "user unit" and is set initially by the following steps as with the motor resolution.

4.1 Determine Parameters

Three parameters are required to be set.

- Unit that is used in your application (Ex. "Rev,""mm")
- Travel amount per one revolution of the motor shaft (distance per revolution)
- Motor resolution

Referring to the examples shown below determine the unit to a value that is actually used. You can set the indivisible number as well using the electronic gear (In this case, five parameters are required to be set). More detail and/or more examples of settings are shown in "7.3 Setting the User Unit" of the operating manual.

Ex.1) You wish to set the travel distance in "revolution" with a resolution of 1000:

The user unit becomes "Rev," the distance per one revolution becomes 1 and the motor resolution becomes 1000.

Ex.2) You wish to set the travel distance in 0.01 mm increments while using a ball screw with a 10mm lead:

The user unit becomes "mm," the distance per one revolution becomes 10 and the motor resolution becomes 1000 (the ball screw travels 10 mm per one motor revolution while the motor moves 0.01 mm per one pulse, "10/0.01 = '1000' pulses per revolution).

Ex.3) When an actuator with **ESMC** controller (0.01 mm resolution) is used:

The user unit becomes "mm," the distance per one millimeter mm becomes 1 and the motor resolution becomes 100.
(1/actuator resolution = 1/0.01= 100)

Memo : Since the resolution of the actuator/**ESMC** controller is based on one millimeter while the resolution of other motors/drivers are based on one revolution. Therefore, the "distance per revolution" parameter on the **SCX10** works as a "distance per millimeter" for the **ESMC** controller.

4.2 Setting Resolution of the Driver

Set the motor resolution, using the switch of the driver.

(For **NX** Series: Set it using the **OPX-2A** data setter or the **MEXE02** data setting software.)

Ex.1)

Set the resolution 1000. (See the operating manual for the driver.)

Ex.2)

Set the resolution 1000. (See the operating manual for the driver.)

Ex.3)

The setting of resolution is not required. The resolution of the **ESMC** controller is fixed.

4.3 Setting Parameters of the SCX10

Start up the installed **Immediate Motion Creator for CM/SCX Series (IMC)**.

1. Turn on the power for the **SCX10** and driver.
2. Connect the **SCX10** mounted using a USB 2.0 cable (mini-B type).
3. Click in the following order: Click start button in Windows - "Programs" - "ORIENTAL MOTOR" - "IMC for CM SCX" - "Immediate Motion Creator for CM SCX Series" (COM port select window is displayed)
4. Select the COM port that is connected to the **SCX10**, and then click [OK].
(Selecting the baud rate is not required at this point. The factory setting, 9600 bps is used to launch.)

Memo If the wrong COM port or baud rate has been set, the **IMC** will launch with offline mode. In this case, select [Set Up] - [Serial Port Set Up] on the menu of the **IMC**. The Serial Port Settings window will be appeared again.

Set the parameter when the **IMC** has been launched.

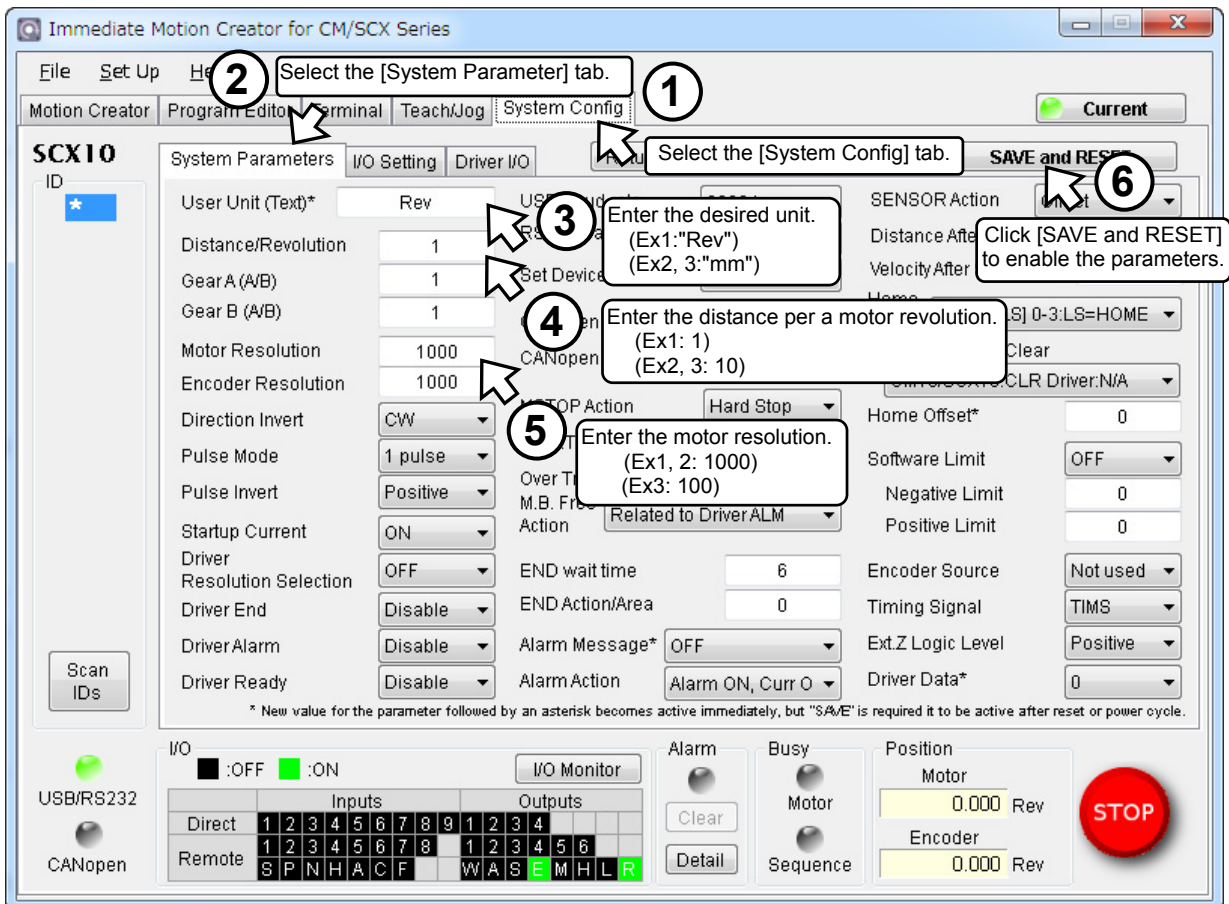

The setting is completed. The parameters have been written to the **SCX10**.

- Memo**
- The rotation direction of the **DG Series** and **DGII Series** hollow rotary actuators are opposite to the CW/CCW input signal of the drivers. If the "Direction Invert" is set to "CCW" on this screen, actual rotation direction becomes CW when a command is positive direction (plus, +). The commanded direction of other actuators and the actual direction in the user application can also be matched by using this function.
 - The setting can also be made using commands. See "7.3 Setting the User Unit" in the **SCX10** operating manual (supplied CD-ROM).
 - Right click on the **IMC** screen and select [Help] will launch the **IMC** Help with the description of function that the mouse cursor is on.

5 Test Operation

Let's try to operate a motor/an actuator and confirm that the use unit is correctly set. After confirming that there is no danger in the surrounding area even when the motor/actuator starts running suddenly, operate it according to the following procedures.

5.1 Test Operation by "Motion Creator" Function of the IMC

At first, let's check the unit for motion parameters. Click the "Motion Creator" tab on the **IMC** window. The units for motion parameters are shown according to the user unit (ex. if the "mm" has been set, the unit for distance should have become "mm" and the unit for velocity should have become "mm/sec.")

Operate the motor/actuator according to the following instruction when the **IMC** has been launched.

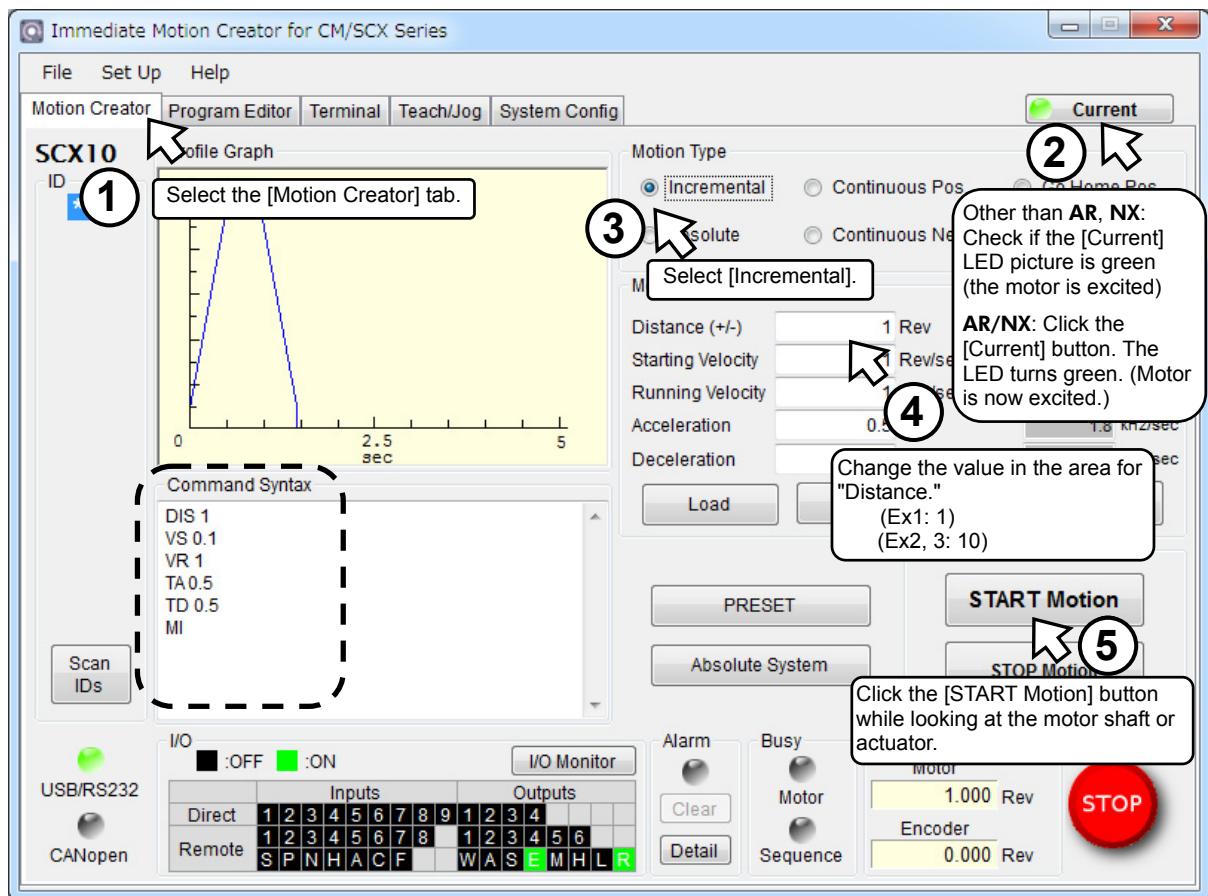

Did the motor/actuator move according to what you set?

- Ex.1) The motor shaft should rotate one revolution in the clockwise direction.
- Ex.2) The motor shaft should rotate one revolution in the clockwise direction and the ball screw should travel 10 mm if the ball screw is connected. (Since a ball screw with a lead of 10 mm/rev is assumed, the motor shaft should rotate one revolution when setting to 10 mm in "Distance")
- Ex.3) The actuator starts to move in the forward direction, and will move 10 mm.

Add a "minus (-)" in front of the value in "Distance," and then click the [START Motion] button again. This time, the motor/actuator should move the same distance in opposite direction and then stop. Change distance, velocity, acceleration and deceleration time, and see difference in motions.

Now, look at the command syntax area in the lower left of the screen.

You can see the letters such as DIS 1, VS 0.1, VR 1 and others. These are the commands that are actually sent to the **SCX10**. For instance, the travel amount is "DIS" (abbreviation for Distance), the starting velocity is "VS" (abbreviation for Velocity for Start) and the running velocity is "VR" (abbreviation for Velocity for Running). Each line corresponds to the operation parameter that was input in ④. "MI" in the last line is abbreviation for Move Incremental, which is the command for starting an operation. The **IMC** sends the command to the **SCX10** on behalf of you.

Let's try executing these commands in the next page.

5.2 Test Operation by Command Input

Here, let us introduce how to command an operation by directly communicating with the **SCX10**. First, click the [Terminal] tab and open the terminal screen. (An operation by commands can be executed using commercially available terminal software as well.)

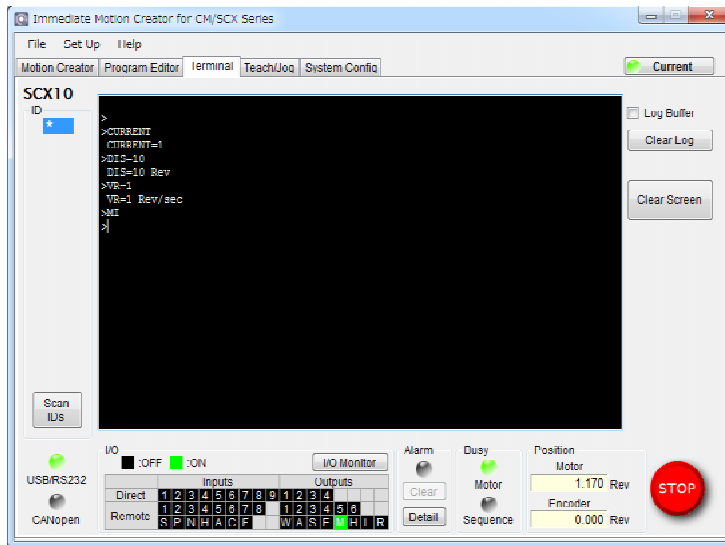

Try to input commands according to the following procedures. For example, you have set user unit parameters with the Ex. 1

Memo

- Case {Upper/Lower} of the character does not matter unless specified.
- An "=" between a parameter and parameter value is required. If the parameter value is a constant, a space can be used instead of an "=". When it is a command (not a parameter) such as MA, a space between command and argument is required. "=" is not accepted.

1. Check that the motor current is ON / Set the motor current ON

<For all drivers except **AR (LSD)/NX Series**>

<For **AR (LSD)/NX Series**>

Enter "CURRENT," and press the Enter key.

```
>CURRENT
CURRENT=1
```

When pressing the Enter key, "CURRENT=1" is displayed in the next line. This is a message that the **SCX10** responded. It shows "CURRENT" command that you typed was accepted and the CURRENT parameter of the **SCX10** is "1" (the motor current is ON).

If "CURRENT=0" is indicated, the motor current is OFF. Enter "CURRENT=1," and press the Enter key. The response with "CURRENT=1" will be displayed and the motor current will be ON.

Enter "CURRENT=1," and press the Enter key.

(A space can be used and replaced with an equal sign between command and parameter.)

```
>CURRENT=1
CURRENT=1
```

When pressing the Enter key, "CURRENT=1" is displayed in the next line. This is a message that the **SCX10** responded. It shows "CURRENT=1" that you typed was accepted and the CURRENT parameter of the **SCX10** was set to "1" (the motor current is turned ON).

When checking the currently set value of a parameter is desired, type only the command ("CURRENT" in this case) and press the Enter key. The parameter that is set to the **SCX10** will be displayed.

2. Set the move distance

Enter "DIS=10," and press the Enter key.

(A space can be used and replaced with an equal sign between command and parameter.)

```
>DIS=10
DIS=10 Rev
```

3. Set the running velocity

Enter "VR=1," and press the Enter key.

```
>VR=1
VR=1 Rev/sec
```

4. Make the motor move

Enter "MI," and press the Enter key.

```
>MI
>
```

The motor starts to move in clockwise direction, and will rotate 10 revolutions at 1 rev/sec.

Were you able to operate the motor properly? Let's change some conditions and operate them.

Ex.1) Invert the direction: Enter "DIS= -10," and press the Enter key. Enter "MI," and press the Enter key. The motor starts to move in reverse direction, and will rotate 10 revolutions at 1 rev/sec.

Ex.2) Change the running velocity: Enter "VR=2," and press the Enter key. Enter "MI," and press the Enter key. The motor starts to move at 2 rev/sec.

Ex.3) Absolute motion: Check the motor position (value) displayed in the lower right of the **IMC** window. This is the current position command that is the distance from the position when the power is turned on. As a trial, enter "MA 10," and press the Enter key. The motor position should move to "10.000" and stop regardless of the current position.

6 Setting the Baud Rate

Use of the USB communication at a baud rate as high as possible (115200 bps if no problem occurs during communication) is recommended for operating the **IMC**. The operation response speed for launching, tab screen change, parameter settings will be improved. Set the baud rate to the **SCX10** according to the following steps.

1. Turn on the power for the **SCX10**, connect to the computer.
2. Launch the **IMC**.
3. Click the [System Config] tab.
4. Click the "USB Baud rate" located at the upper-center, and select "115200 bps" from the drop-down list.
(For an operator using RS-232C, set the "RS232 Baud rate.")
5. Click the [SAVE and RESET] to enable the change. At that time, the **IMC** also changes the baud rate of computer side to 115200 bps. (The **SCX10** is already communicating with your computer at 115200 bps.)

Note

When starting communication with the **SCX10**, be sure to set the baud rate of the **IMC** to the same baud rate that has been set to the **SCX10**. If you are unsure about the baud rate of the **SCX10**, use the "Scan Baud Rate" button on the Serial Port Settings window. If the wrong baud rate has been set in the Serial Port Settings window, not only will the communication not be established, but it may also be possible that the communication will never be established even if the baud rate is correctly set afterwards. If this communication problem occurs, turn off the power to the **SCX10**, wait for a few seconds and restart. Take the same action when communication is likely to be disconnected.

7 Features

7.1 Features of the SCX10

The **SCX10** can be used with ease, in addition, the **SCX10** can perform most operations that you can imagine with a feature rich interface and functions.

See below in the operating manual (in supplied CD-ROM) for instructions.

- For motion types and features: "8 Features"
- For executing sequences: "9 Program Creation and Execution"
- For CANopen communication: "10 Control by CANopen Communication"
- Other functions that has not been explained in above: "Appendix C TIPS"

7.2 Support of Driver Functions

The **SCX10** can be performed most of the drivers' functions and signals for I/O using commands. The connection and signals are explained in "6.5 connecting the Driver" of the operating manual and the settings are explained in "7.5 Optional Settings for Driver" of the operating manual. Also, the following specific functions are explained in the section on the individual page.

For **AR** Series driver (AC and DC input type)

- If the push motion operation is required, see "8.5 Torque Limiting/Push-motion Operation"

For **NX** Series driver

- If the torque limiting operation is required, see "8.5 Torque Limiting/Push-motion Operation"
- If the current position reading is required, see "8.6 Driver Current Position Reading"
- If the accurate return-to-mechanical home operation is required such as using the Z-phase signal (timing signal), see "HOMEDCL (deviation counter clear select at mechanical home seeking operation)" section in "8.2.5 Mechanical Home Seeking"

For **ESMC** controller

- If the current position reading function is required, see "8.6 Driver Current Position Reading"
- If the sensor-less mechanical home seeking operation is required, see "Sensorless Mechanical Home Seeking Operation for HOMETYP=12" section in "8.2.5 Mechanical Home Seeking"

Settings for the **SCX10** and driver are required to change when using above functions since some necessary signals are not assigned to the driver I/Os with the factory setting. See "6.5.3 Change of Signal Assignment."

• Please contact your nearest Oriental Motor office for further information.

ORIENTAL MOTOR U.S.A. CORP.
Technical Support Tel:(800)468-3982
8:30 A.M. to 5:00 P.M., P.S.T. (M-F)
7:30 A.M. to 5:00 P.M., C.S.T. (M-F)
E-mail: techsupport@orientalmotor.com
www.orientalmotor.com

ORIENTAL MOTOR (EUROPA) GmbH
Headquarters and Düsseldorf Office
Tel:0211-52067-00 Fax:0211-52067-099
Munich Office
Tel:089-3181225-00 Fax:089-3181225-25
Hamburg Office
Tel:040-76910443 Fax:040-76910445

ORIENTAL MOTOR (UK) LTD.
Tel:01256-347090 Fax:01256-347099

ORIENTAL MOTOR (FRANCE) SARL
Tel:01 47 86 97 50 Fax:01 47 82 45 16

ORIENTAL MOTOR ITALIA s.r.l.
Tel:02-93906346 Fax:02-93906348

SHANGHAI ORIENTAL MOTOR CO.,LTD.
Tel:400-820-6516 Fax:021-6278-0269

TAIWAN ORIENTAL MOTOR CO.,LTD.
Tel:(02)8228-0707 Fax:(02)8228-0708

SINGAPORE ORIENTAL MOTOR PTE LTD
Tel:+65-6745-7344 Fax:+65-6745-9405

ORIENTAL MOTOR (MALAYSIA) SDN. BHD.
Tel:(03)22875778 Fax:(03)22875528

ORIENTAL MOTOR (THAILAND) CO.,LTD.
Tel:+66-2-251-1871 Fax:+66-2-251-1872

INA ORIENTAL MOTOR CO.,LTD.
KOREA
Tel:080-777-2042 Fax:02-2026-5495

ORIENTAL MOTOR CO.,LTD.
Headquarters Tokyo, Japan
Tel:03-6744-0361 Fax:03-5826-2576