

Cooling Fans

Enclosure Fan Modules

Overview,
Product
Series

Axial
Flow
Fans

AC Input
Low-Power
Consumption
EMU

AC Input
Compact Size
MU

AC Input
Large Size,
Large Air Flow
MRS

AC Input
Long-Life
MRE

DC Input
MDS
MD

DC Input
Alarm
MDA

DC Input
Variable Flow
MDV

DC Input
Long-Life
MDE

DC Input
Splash Proof
MDP

Centrifugal
Blowers

AC Input
MB
DC Input
MBD

Cross Flow Fans

AC Input
MF
DC Input
MFD

Enclosure Fan Modules

Enclosure Fan
Modules

Thermostat

Accessories

Installation

Enclosure Fan Modules

For details on this product please refer to our website.
www.orientalmotor.com/catalog



These enclosure fan modules combine an axial flow fan with peripheral equipment, such as finger guard, filter media, frame and mounting hardware.



View Expanded Product Information, Specifications, CAD, Accessories & more online. Visit www.orientalmotor.com/catalog or use the QR code and select "Enclosure Fan Modules".





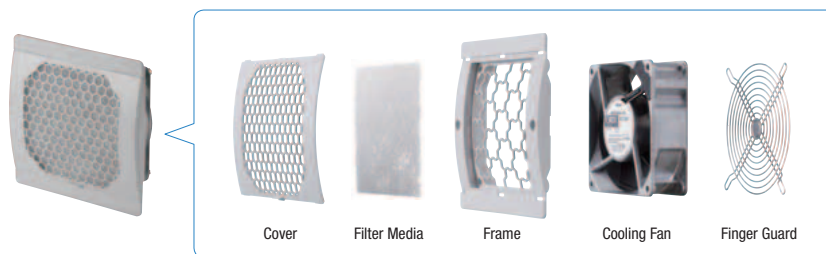

What is an Enclosure Fan?

An Enclosure Fan is a combination package consisting of an axial flow fan and peripheral equipment (cover, filter media, frame and finger guard). It is suitable for cooling a control box or other enclosure.

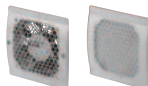

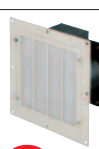
● For finger guard IP2X type with filter, the product is delivered fully assembled.

Lineup

Module (Color) List Price	Module Dimensions W×H [mm (in.)]					
	129×134 (5.08×5.28)	157×170 (6.18×6.69)	161×158 (6.34×6.22)	180×180 (7.09×7.09)	209×226 (8.23×8.90)	284×284 (11.2×11.2)
Finger Guard IP2X Type (Light Gray) \$50.00~			 AC DC □119 mm (4.69 in.) Fan Max. Air Flow: 2.7 m ³ /min (95.3 CFM)			
Slit Metal Plate IP4X Type (Light Beige) \$94.00~				 AC DC □119 mm (4.69 in.) Fan Max. Air Flow: 1.1 m ³ /min (38.8 CFM)		 AC □180 mm (7.09 in.) Fan Max. Air Flow: 8.3 m ³ /min (293 CFM)
Dust and Water Resistant IP43 Type IP55 Type (Light Gray) \$84.00~	 AC □92 mm (3.62 in.) Fan Max. Air Flow: 0.49 m ³ /min (17.3 CFM)	 AC DC □119 mm (4.69 in.) Fan Max. Air Flow: 0.83 m ³ /min (29.3 CFM)			 AC DC □119 mm (4.69 in.) Fan Max. Air Flow: 1.5 m ³ /min (53.0 CFM)	

● For finger guard modules, enclosure fan modules that are equipped with filters and those that are not equipped with filters are available. Slit metal plate modules and dust and water resistant modules are equipped with filters.
 ● All modules are available in 2 types of air flow direction: suction type and exhaust type.
 ● Maximum air flow values are examples.

Differentiating Features

Finger Guard
IP2X Type

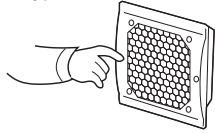

Can offer protection against finger contact.

Slit Metal Plate
IP4X Type

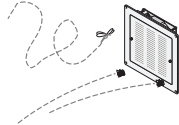

The equipment is protected against ingress of wires [with a diameter of 1 mm (0.04 in.) or more]

Dust and Water Resistant
IP43 Type

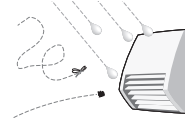

The equipment is protected against ingress of wires [with a diameter of 1 mm (0.04 in.) or more] and sprayed water (coming from directions within a range of 60° relative to the vertical plane)

Dust and Water Resistant
IP55 Type

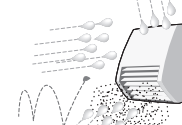

The equipment is protected against the ingress of dust and water jets (from all directions)

For information about degree of protection → Page I-8

Features

Integrated Structure

Because the enclosure fan modules have an integrated structure, their characteristics are clear, and they are easy to select and easy to install. Also, their integrated structure makes them easy to order.

Clearly Defined Characteristics Make Ordering Easy

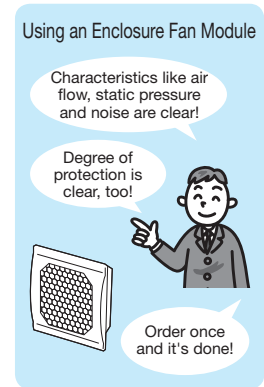
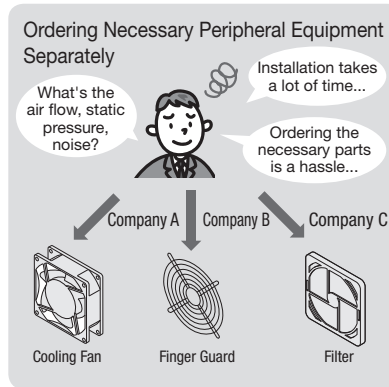
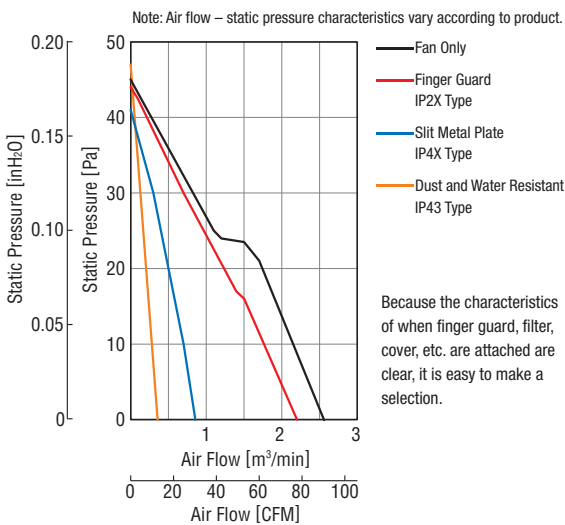

Easy Installation

When Necessary Peripheral Equipment are Ordered Separately

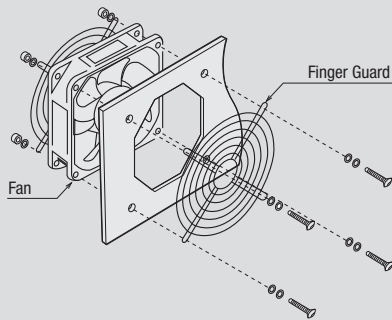

Assembling multiple parts screw by screw takes time, and replacement is difficult.

Installation is Easy with the Integrated Structure of the Enclosure Fan Module

(When using finger guard IP2X type)

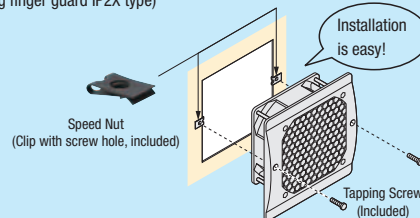

Speed Nut Improves Work Efficiency

By inserting the speed nut into the installation plate, the fan module can be fixed with tapping screws from the exterior of the control box.

Installation holes are easy-to-machine square holes.

Using Axial Flow Fan Alone

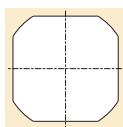

[Outlet Side]

Using Enclosure Fan Module

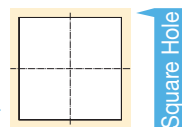

Square Hole

Easy Maintenance

The body cover can be easily detached from the outside. Filter media replacement is easy.

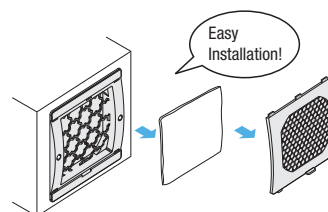

Body | Filter Media | Cover (When using finger guard IP2X type)

Overview, Product Series

Axial Flow Fans

AC Input Low-Power Consumption EMU

AC Input Compact Size MU

AC Input Large Size, Large Air Flow MRS

AC Input Long-Life MRE

DC Input MDS MD

DC Input Alarm MDA

DC Input Variable Flow MDV

DC Input Long-Life MDE

DC Input Splash Proof MDP

Centrifugal Blowers

AC Input MB
DC Input MBD

Cross Flow Fans

AC Input MF
DC Input MFD

Enclosure Fan Modules

Thermostat

Accessories

Installation

Improvement of Equipment Reliability (Slit Metal Plate IP4X Type, Dust and Water Resistant IP43-IP55 Type)

If dust or water droplets enter the control box, the internal devices may malfunction, which can affect the entire equipment system. The slit metal plate IP4X type modules and the dust and water resistant IP43-IP55 type modules prevent the infiltration of dust and water droplets, which improves the service life and reliability of the devices contained in the enclosure.

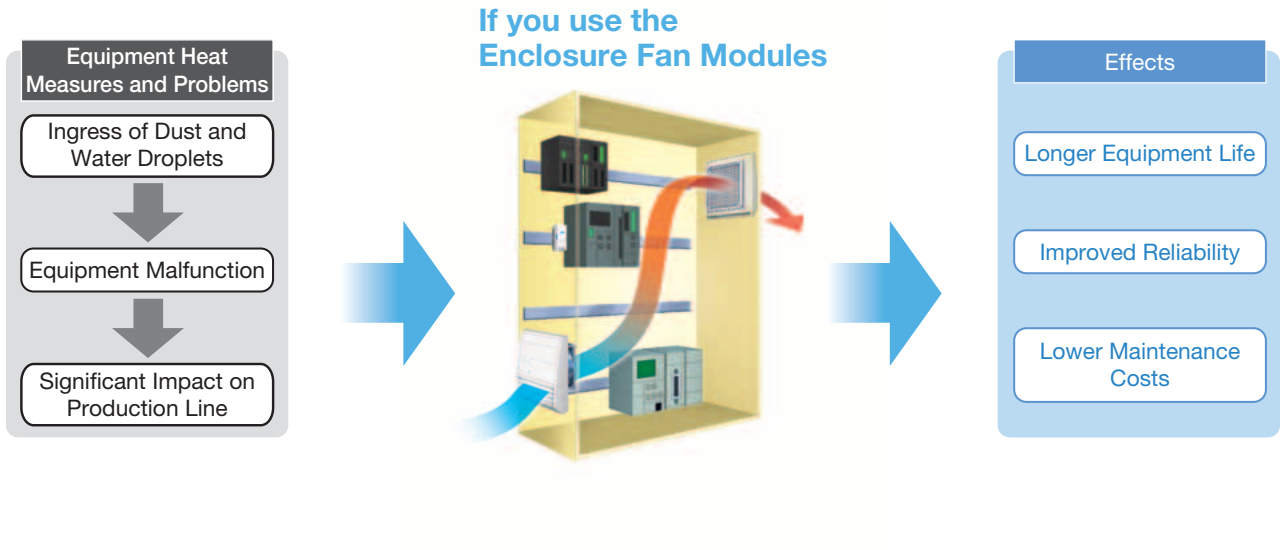

Application Example

Environment with Dust and Water Droplets

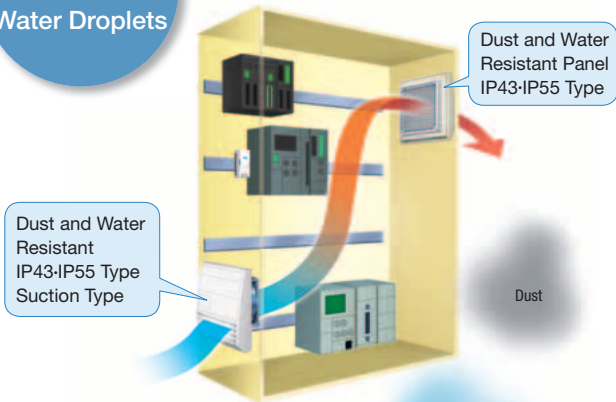

Air is suctioned using the fans at the bottom, and exhausted from the panel at the top. The pressure inside the enclosure is raised, so that dust does not easily enter the enclosure through gaps other than those on the suction intake side (such as through gaps at case joints and around cable holes).

Enclosure Contains Many Devices and Internal Temperature is High

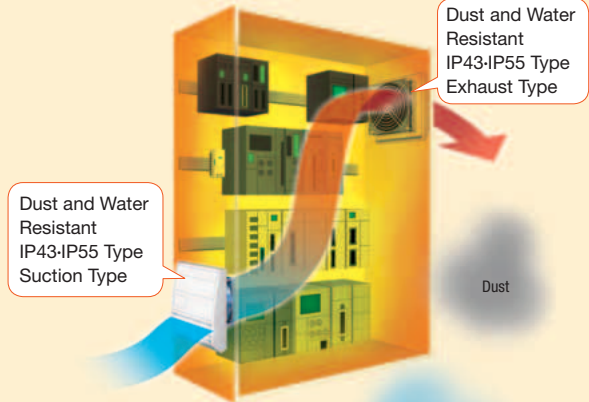

Air is suctioned using the fans at the bottom, and exhausted from the fans at the top. This method is suitable for applications where components are densely installed in the enclosure and the method on the left does not provide sufficient cooling.

Environment Free of Dust and Water Droplet

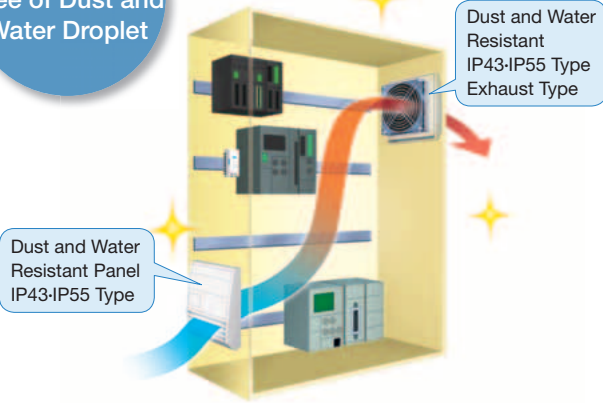

The pressure inside the enclosure is lowered, so that air does not easily leak out through gaps other than the outlet side (such as through gaps at case joints and around cable holes). Appropriate for use in an environment with no dust or water droplets nearby.

Further Reduction in Power Consumption and Noise with the Use of a Fan Thermostat

What is a Fan Thermostat?
It is a switch that turns the contact ON when a set temperature is reached. When used with a fan, it can control the ON/OFF state of the fan.

Reduced Power Consumption!

The fan operates only when necessary



Additional Benefits!

- Minimizes noise when the fan is rotating!
- Multiple fans can be controlled simultaneously!

Fan Thermostat AM2-XA1



● For details, check page G-104.

Overview, Product Series

Axial Flow Fans

AC Input Low-Power Consumption EMU

AC Input Compact Size MU

AC Input Large Size, Large Air Flow MRS

AC Input Long-Life MRE

DC Input MDS MD

DC Input Alarm MDA

DC Input Variable Flow MDV

DC Input Long-Life MDE

DC Input Splash Proof MDP

Centrifugal Blowers

AC Input MB
DC Input MBD

Cross Flow Fans

AC Input MF
DC Input MFD

Enclosure Fan Modules

Thermostat

Accessories

Installation

Product Number

● Enclosure Fan Modules

◇ Finger Guard IP2X Type

C - MU1238A-21B - G E F G

① ② ③ ④ ⑤ ⑦

◇ Slit Metal Plate IP4X Type

C - MU1225S-21 - S E G

① ② ③ ④ ⑦

◇ Dust and Water Resistant IP43-IP55 Type

C - MU1238B-21B - P E W M G

① ② ③ ④ ⑤ ⑥ ⑦

● Enclosure Fan Modules

①	Enclosure Fan Module Order Code	
②	Product Name of Mounted Fan	
③	Type of Modules	G : Finger Guard IP2X Type S : Slit Metal Plate IP4X Type P : Dust and Water Resistant IP43-IP55 Type
④	Cooling Method	E : Exhaust Type S : Suction Type
⑤	Additional Function	Filter (Finger Guard IP2X Type) Blank: No additional functions F : With Filter Degree of Protection (Dust and Water Resistant IP43-IP55 Type) Blank: IP43 W : IP55
⑥	Module Size	M : Middle L : Large
⑦	Finger Guard	G : Finger Guard Attached

Product Line

● AC Input

◇ Fan and Finger Guard IP2X Type

Module Dimensions W×H [mm (in.)]	Installed Fan	Power Supply Voltage VAC	Cooling Method	Product Name	List Price
161×158 (6.34×6.22)	□ 119 mm - 38 mm Thick (□ 4.69 in. - 1.50 in. Thick)	Single-Phase 115	Exhaust Type	C-MU1238A-21B-GEG	\$58.00
			Suction Type	C-MU1238A-21B-GSG	\$58.00
		Single-Phase 220/230	Exhaust Type	C-MU1238A-51B-GEG	\$60.00
			Suction Type	C-MU1238A-51B-GSG	\$60.00

◇ Fan and Finger Guard IP2X Type with Filter

Module Dimensions W×H [mm (in.)]	Installed Fan	Power Supply Voltage VAC	Cooling Method	Product Name	List Price
161×158 (6.34×6.22)	□ 119 mm - 38 mm Thick (□ 4.69 in. - 1.50 in. Thick)	Single-Phase 115	Exhaust Type	C-MU1238A-21B-GEFG	\$65.00
			Suction Type	C-MU1238A-21B-GSFG	\$65.00
		Single-Phase 220/230	Exhaust Type	C-MU1238A-51B-GEFG	\$66.00
			Suction Type	C-MU1238A-51B-GSFG	\$66.00

◇ Fan and Slit Metal Plate IP4X Type

Module Dimensions W×H [mm (in.)]	Installed Fan	Power Supply Voltage VAC	Cooling Method	Product Name	List Price
180×180 (7.09×7.09)	□119 mm - 25 mm Thick (□4.69 in. - 0.98 in. Thick)	Single-Phase 115	Exhaust Type	C-MU1225S-21-SEG	\$105.00
			Suction Type	C-MU1225S-21-SSG	\$105.00
		Single-Phase 220/230	Exhaust Type	C-MU1225S-51-SEG	\$105.00
			Suction Type	C-MU1225S-51-SSG	\$105.00
	□119 mm - 38 mm Thick (□4.69 in. - 1.50 in. Thick)	Single-Phase 115	Exhaust Type	C-MU1238A-21B-SEG	\$104.00
			Suction Type	C-MU1238A-21B-SSG	\$104.00
		Single-Phase 220/230	Exhaust Type	C-MU1238A-51B-SEG	\$105.00
			Suction Type	C-MU1238A-51B-SSG	\$105.00
284×284 (11.2×11.2)	□180 mm - 90 mm Thick (□7.09 in. - 3.54 in. Thick)	Single-Phase 100/110/115	Exhaust Type	C-MRS18-BH-SEG	\$399.00
			Suction Type	C-MRS18-BH-SSG	\$399.00
		Single-Phase 200/220/230	Exhaust Type	C-MRS18-DH-SEG	\$409.00
			Suction Type	C-MRS18-DH-SSG	\$409.00

◇ Fan and Dust and Water Resistant IP43 Type

Module Dimensions W×H [mm (in.)]	Installed Fan	Power Supply Voltage VAC	Cooling Method	Product Name	List Price	
129×134 (5.08×5.28)	□92 mm - 25 mm Thick (□3.62 in. - 0.98 in. Thick)	Single-Phase 115	Exhaust Type	C-MU925S-21-PEG	\$84.00	
		Single-Phase 115	Suction Type	C-MU925S-21-PSG	\$84.00	
		Single-Phase 220/230	Exhaust Type	C-MU925S-51-PEG	\$85.00	
		Single-Phase 220/230	Suction Type	C-MU925S-51-PSG	\$85.00	
157×170 (6.18×6.69)	□119 mm - 38 mm Thick (□4.69 in. - 1.50 in. Thick)	Single-Phase 115	Exhaust Type	C-MU1238B-21B-PEMG	\$96.00	
C-MU1238B-21B-PELG				\$108.00		
209×226 (8.23×8.90)			Suction Type	C-MU1238B-21B-PSMG	\$96.00	
C-MU1238B-21B-PSLG				\$108.00		
157×170 (6.18×6.69)			Single-Phase 220/230	Exhaust Type	C-MU1238B-51B-PEMG	\$97.00
209×226 (8.23×8.90)					C-MU1238B-51B-PELG	\$109.00
157×170 (6.18×6.69)		Suction Type		C-MU1238B-51B-PSMG	\$97.00	
209×226 (8.23×8.90)				C-MU1238B-51B-PSLG	\$109.00	

◇ Fan and Dust and Water Resistant IP55 Type

Module Dimensions W×H [mm (in.)]	Installed Fan	Power Supply Voltage VAC	Cooling Method	Product Name	List Price	
129×134 (5.08×5.28)	□92 mm - 25 mm Thick (□3.62 in. - 0.98 in. Thick)	Single-Phase 115	Exhaust Type	C-MU925S-21-PEWG	\$93.00	
		Single-Phase 115	Suction Type	C-MU925S-21-PSWG	\$93.00	
		Single-Phase 220/230	Exhaust Type	C-MU925S-51-PEWG	\$94.00	
		Single-Phase 220/230	Suction Type	C-MU925S-51-PSWG	\$94.00	
157×170 (6.18×6.69)	□119 mm - 38 mm Thick (□4.69 in. - 1.50 in. Thick)	Single-Phase 115	Exhaust Type	C-MU1238B-21B-PEWVG	\$105.00	
C-MU1238B-21B-PEWLG				\$117.00		
209×226 (8.23×8.90)			Suction Type	C-MU1238B-21B-PSWVG	\$105.00	
C-MU1238B-21B-PSWLG				\$117.00		
157×170 (6.18×6.69)			Single-Phase 220/230	Exhaust Type	C-MU1238B-51B-PEWVG	\$106.00
209×226 (8.23×8.90)					C-MU1238B-51B-PEWLG	\$118.00
157×170 (6.18×6.69)		Suction Type		C-MU1238B-51B-PSWVG	\$106.00	
209×226 (8.23×8.90)				C-MU1238B-51B-PSWLG	\$118.00	

Overview,
Product
SeriesAxial
Flow
FansAC Input
Low-Power
Consumption
EMUAC Input
Compact Size
MUAC Input
Large Size,
Large Air Flow
MRSAC Input
Long-Life
MREDC Input
MDS
MDDC Input
Alarm
MDADC Input
Variable Flow
MDVDC Input
Long-Life
MDEDC Input
Splash Proof
MDPCentrifugal
BlowersAC Input
MB
DC Input
MBD

Cross Flow Fans

AC Input
MF
DC Input
MFDEnclosure Fan
Modules

Thermostat

Accessories

Installation

● DC Input

◇ Fan and Finger Guard IP2X Type

Module Dimensions W×H [mm (in.)]	Installed Fan	Power Supply Voltage VDC	Cooling Method	Product Name	List Price
161×158 (6.34×6.22)	□119 mm - 25.4 mm Thick (□4.69 in. - 1.00 in. Thick)	24	Exhaust Type	C-MD1225-24H-GEG	\$50.00
			Suction Type	C-MD1225-24H-GSG	\$50.00
			Exhaust Type	C-MDS1225-24H-GEG	\$58.00
			Suction Type	C-MDS1225-24H-GSG	\$58.00

◇ Fan and Finger Guard IP2X Type with Filter

Module Dimensions W×H [mm (in.)]	Installed Fan	Power Supply Voltage VDC	Cooling Method	Product Name	List Price
161×158 (6.34×6.22)	□119 mm - 25.4 mm Thick (□4.69 in. - 1.00 in. Thick)	24	Exhaust Type	C-MD1225-24H-GEFG	\$56.00
			Suction Type	C-MD1225-24H-GSFG	\$56.00
			Exhaust Type	C-MDS1225-24H-GEFG	\$64.00
			Suction Type	C-MDS1225-24H-GSFG	\$64.00

◇ Fan and Slit Metal Plate IP4X Type

Module Dimensions W×H [mm (in.)]	Installed Fan	Power Supply Voltage VDC	Cooling Method	Product Name	List Price
180×180 (7.09×7.09)	□119 mm - 25.4 mm Thick (□4.69 in. - 1.00 in. Thick)	24	Exhaust Type	C-MD1225-24H-SEG	\$94.00
			Suction Type	C-MD1225-24H-SSG	\$94.00
180×180 (7.09×7.09)			Exhaust Type	C-MDS1225-24H-SEG	\$104.00
			Suction Type	C-MDS1225-24H-SSG	\$104.00

◇ Fan and Dust and Water Resistant IP43 Type

Module Dimensions W×H [mm (in.)]	Installed Fan	Power Supply Voltage VDC	Cooling Method	Product Name	List Price
157×170 (6.18×6.69)	□119 mm - 25.4 mm Thick (□4.69 in. - 1.00 in. Thick)	24	Exhaust Type	C-MD1225-24H-PEMG	\$96.00
209×226 (8.23×8.90)				C-MD1225-24H-PELG	\$108.00
157×170 (6.18×6.69)			Suction Type	C-MD1225-24H-PSMG	\$96.00
209×226 (8.23×8.90)				C-MD1225-24H-PSLG	\$108.00

◇ Fan and Dust and Water Resistant IP55 Type

Module Dimensions W×H [mm (in.)]	Installed Fan	Power Supply Voltage VDC	Cooling Method	Product Name	List Price
157×170 (6.18×6.69)	□119 mm - 25.4 mm Thick (□4.69 in. - 1.00 in. Thick)	24	Exhaust Type	C-MD1225-24H-PEWVG	\$105.00
209×226 (8.23×8.90)				C-MD1225-24H-PEWVG	\$117.00
157×170 (6.18×6.69)			Suction Type	C-MD1225-24H-PSWVG	\$105.00
209×226 (8.23×8.90)				C-MD1225-24H-PSWVG	\$117.00

For details (specifications, characteristics, dimensions and others) on these products please refer to either to our website, contact technical support or your nearest Oriental Motor sales office.

www.orientalmotor.com/catalog