

## Compact Electric Cylinders

# DR Series

## $\alpha$ STEP AZ Series Equipped

This linear motion actuator incorporates a ball screw into a stepper motor and offers the ability to reduce the size and weight of the overall machine.

**AZ** Series features a hybrid control system for the drive motor. Because the **AZ** Series uses battery-free absolute sensors (ABZO sensors), other external sensors, such as a home sensor or limit sensor are not necessary.



Table Type



Wide Table Type



Rod Type



Guide Rod Type

Lead Screw Pitch options:  
1 mm/ 2.5 mm

## Reduces Startup Time

- Houses Entire Linear Motion

# of Components can be Reduced

◇ If Designed with Components

Number of components: 9

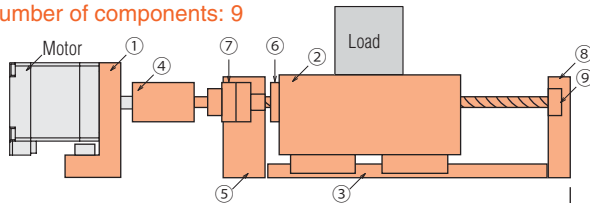

◇ When Using a DR Series Table Type

Number of components: 1

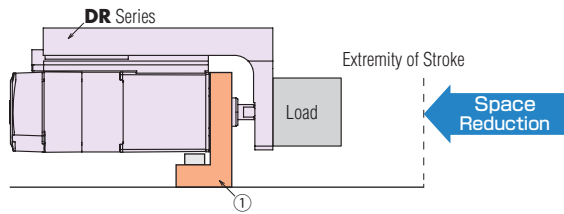

[Parts Used]	① Installation plate	② Transportation table	③ Linear guide	④ Coupling
	⑤ Fixed-side block	⑥ Ball screw	⑦ Fixed-side bearing	
	⑧ Support-side block	⑨ Support-side bearing		

- No Home Sensor Required

Less Wiring with the Absolute Sensor

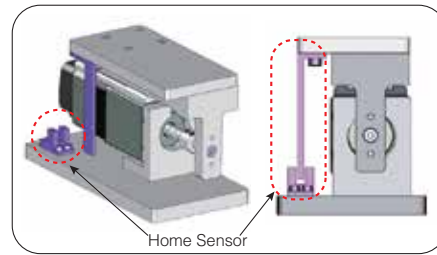

When the Home Sensor is Attached

No Sensor Required with AZ Technology

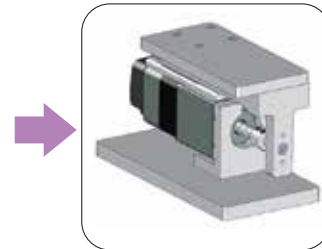

When the Home Sensor is Not Attached

## Typical Applications

Driving an X-Y Stage  
(Automated micrometer head)

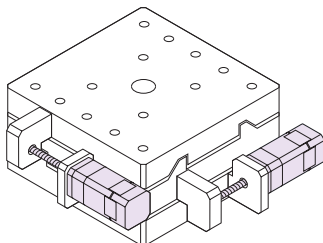

Centering of a Board

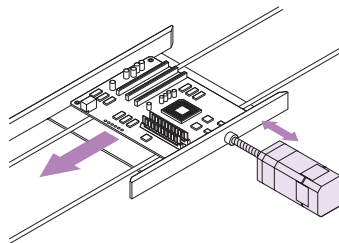

Vertical Movement of Probes

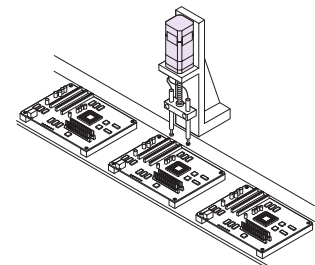

Visit [www.orientalmotor.com](http://www.orientalmotor.com)

For further information (specifications, dimensions, speed-torque characteristics)

# Product Line

## Rod Type



Uses a thrust force mounted in the machine

## Rod Type With Guide



Thrust force with additional stability with guide

## Table Type



Attach the load to the table

## Wide Table Type



Attach the load to the table

- **Frame Size: 28 mm**
- **Stroke: 30 mm**
- **Ball Screw Pitch: 1 mm/ 2.5 mm**

### ● With Ball Screw Cover (Option)



## Driver Types (24 VDC)



Built-in Controller



RS-485 Communication Pulse Input



Pulse Input



EtherCAT  
EtherNet/IP



Multi Axis EtherCAT

## System Configuration

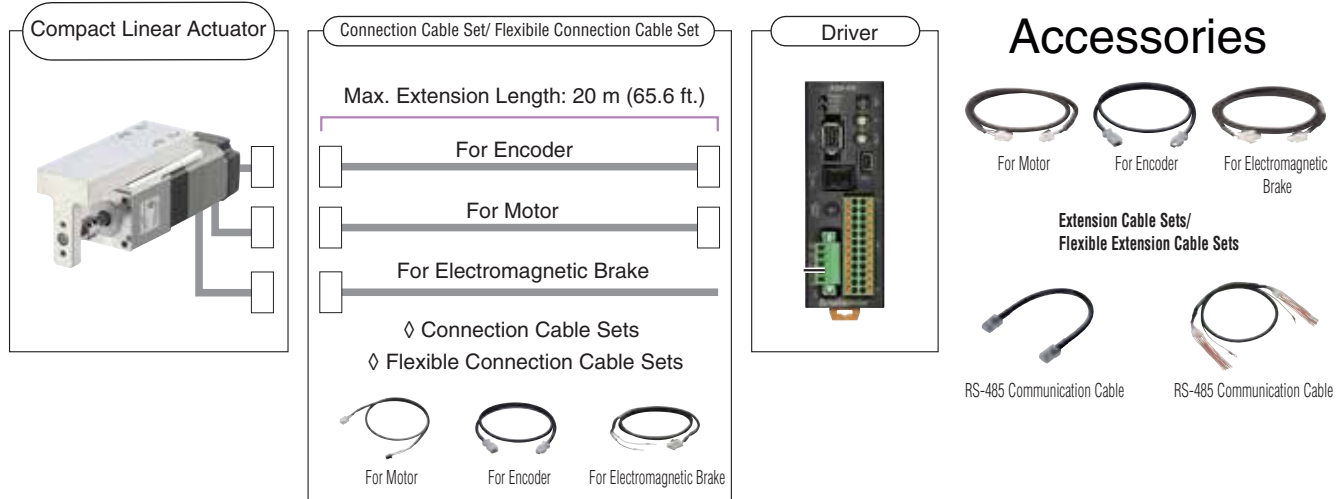

DR Series		
Compact Linear Actuator	Driver	Connection Cable
DR28R1BC03-AZAKU	AZD-KD	CCM005VZ2F2
<b>\$1,164.00</b>	<b>\$441.00</b>	<b>\$35.00</b>

+

Accessory
Connection Cable Set
CC16D010B-1
<b>\$25.00</b>

## ORIENTAL MOTOR U.S.A. CORP.

Technical Support Tel: 800-468-3982 7:30A.M. - 7:00P.M. C.S.T (M-F) E-mail: techsupport@orientalmotor.com

- 1,500 Products Next Day Shipping
- Free Sizing

- Over 10,000 Products Shipped within 7~9 Business Days
- Global Support