

$\alpha$ STEP

## AZ Series DC Input

### Compact Driver

### Direct Connection Motor for Compact Drivers

New compact drivers work with a variety of  $\alpha$ STEP products, including the new Harmonic geared type motors, which can be connected directly to the compact driver without the use of connection cables.

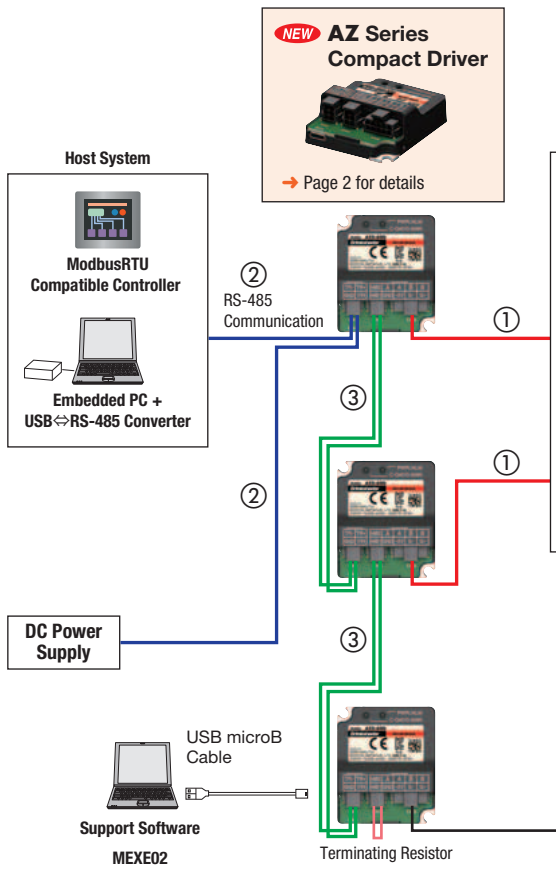
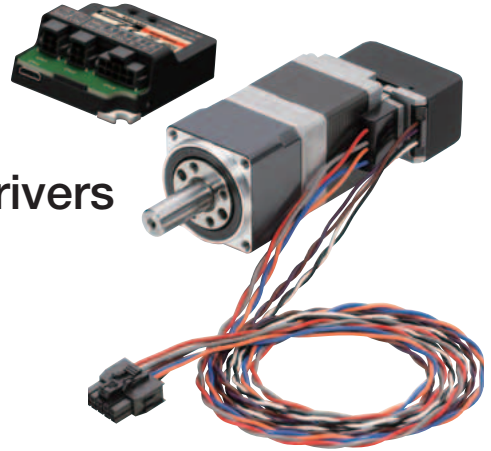

● **AZ Series Motors / AZ Series Equipped Actuators**

These products connect to a compact driver using compact driver connection cables.

The products below are a representative example.

<b>AZ Series</b>	<b>DGII Series</b> Hollow Rotary Actuators Equipped with <b>AZ Series</b>	<b>EZS Series with</b> <b>AZ Series</b>	<b>EAC Series</b> Electric Linear Cylinders Equipped with <b>AZ Series</b>
<b>Compact Electric Linear Cylinders</b> <b>DR Series</b>	<b>Compact Electric Linear Cylinders</b> <b>DRS2 Series</b>	<b>Motorize Gripper</b> <b>EH Series</b>	

● **AZ Series Direct Connection Motor for Compact Drivers** → Page 4 for details

These products connect directly to a compact driver without use of compact driver connection cables.

<b>NEW</b> Harmonic Geared Type Frame Size 30 mm [1.18 in.]	<b>NEW</b> Harmonic Geared Type with Electromagnetic Brake Frame Size 42 mm [1.65 in.]

● **AZ Series Compact Driver Cables** → Page 7 for details

Use Oriental Motor connection cables when connecting **AZ Series / AZ Series** equipped actuators to compact drivers.  
Power Supply/Communication cables are also available.

<b>LC002Z</b> <b>LC003Z2</b>	<b>LC010-RS</b>	<b>LC005-RW</b>

\*Corresponds to ① ② ③ in the illustration above.

# AZ Series DC Input Compact Driver



This driver can be controlled using RS-485 communication. The elimination of switches and I/O connectors allows for a compact and lightweight design.

## Features

### Compact and Lightweight Design

#### Increased Design Freedom

Compact design allows for installation in tight spaces. With a weight of just 39 g (1.4 oz), even when installed on moving components, the load torque and inertial moment can be reduced, resulting in more freedom in mechanical and control cabinet design.

In addition, by installing the driver close to the motor, the connection cables can be shortened, resulting in reduced equipment weight, decreased costs and a reduction in complicated wiring work.

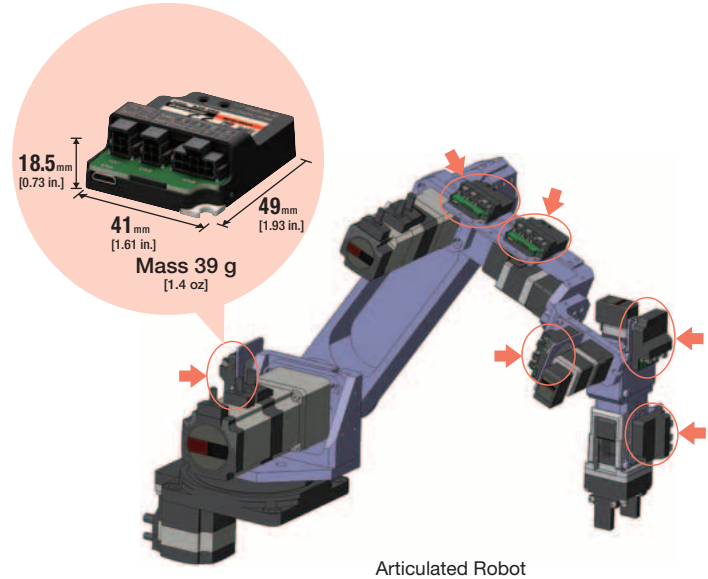

### Reduced Wiring and Reduced Costs

#### Control Via RS-485 Communication

RS-485 communication can be used to set operating data and parameters, as well as input operation commands. The protocol is supported by Modbus (RTU) and can be used to connect to touch screens and computers.

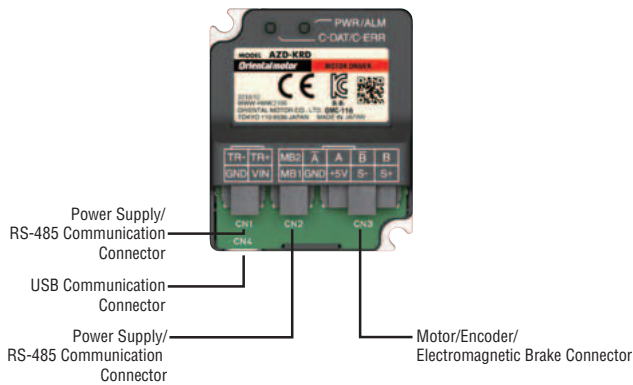

- Easy Control
- Simple Wiring
- Serial Communication Module Compatible
- Motor Control Using a Computer
- Simplified System

## Prices

Product Name	List Price
<b>AZD-KRD</b>	\$391.00

#### Daisy-Chaining\*

A daisy-chain connection of multiple drivers to the host and power supply is supported. This provides the advantage of reduced wiring and easier connection management and maintenance.

\*When daisy-chaining to a power supply, make sure that the total input current for the drivers is 6.5 A or less.

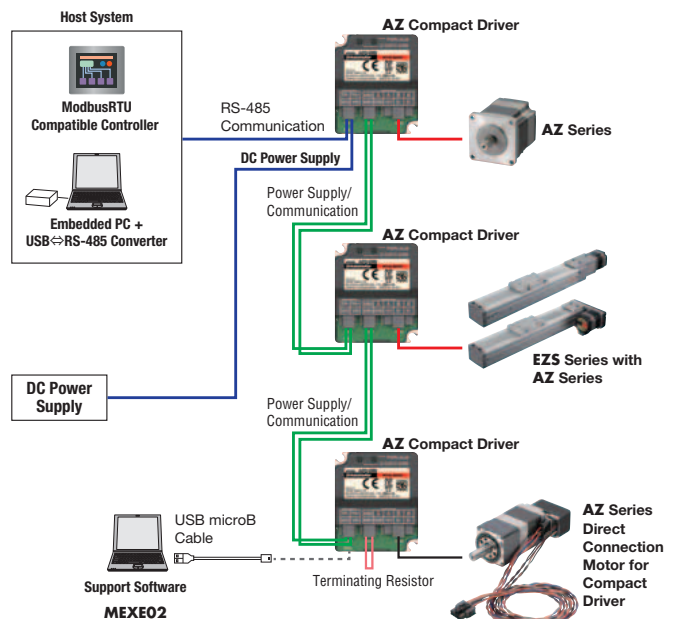

## Specifications

Power Supply Input		24 VDC $\pm$ 5% / 48 VDC $\pm$ 5%
I/O Functions	Number of Positioning Data Sets	256 Points
	RS-485 Communication Remote Input	16 Points
	RS-485 Communication Remote Output	16 Points
Maximum Cable Extension Length		Power Supply/ Communication Cable: 5 m [16.4 ft.] Motor/Encoder/Electromagnetic Brake Cable: 0.5 m [1.6 ft.] including motor's own cable
Operating Environment	Ambient Temperature	0 to 50°C [32~122°F] (Non-freezing)
	Ambient Humidity	85% or less (Non-condensing)
	Altitude	Up to 1000 m [3281 ft.] above sea level
	Atmosphere	Use in an area without corrosive gases and dust. The product should not be exposed to water, oil or other liquids.
Storage Conditions Shipping Conditions	Ambient Temperature	-25 to +70°C [-13~158°F] (Non-freezing)
	Ambient Humidity	85% or less (Non-condensing)
	Altitude	Up to 3000 m [9843 ft.] above sea level
	Atmosphere	Use in an area without corrosive gases and dust. The product should not be exposed to water, oil or other liquids.

● Driver setting is performed through Modbus communication or **MEXE02** support software. Please contact Oriental Motor for details.

## RS-485 Communication Specifications

Electrical Characteristics	Complies with EIA-485. Use twisted-pair cables, max. total extension length is 5 m [16.4 ft.].
Communication Mode	Half duplex Start-stop synchronization (data: 8 bits, stop bit: 1 bit or 2 bits, parity: none, even, or odd)
Protocol	Modbus RTU protocol
Baud Rate	Select from 9600 bps, 19200 bps, 38400 bps, 57600 bps, 115200 bps and 230400 bps
Connection Type	Up to 31 units can be connected to a single host system.

## Dimensions Unit = mm (in.)

Mass: 39g (1.4 oz)

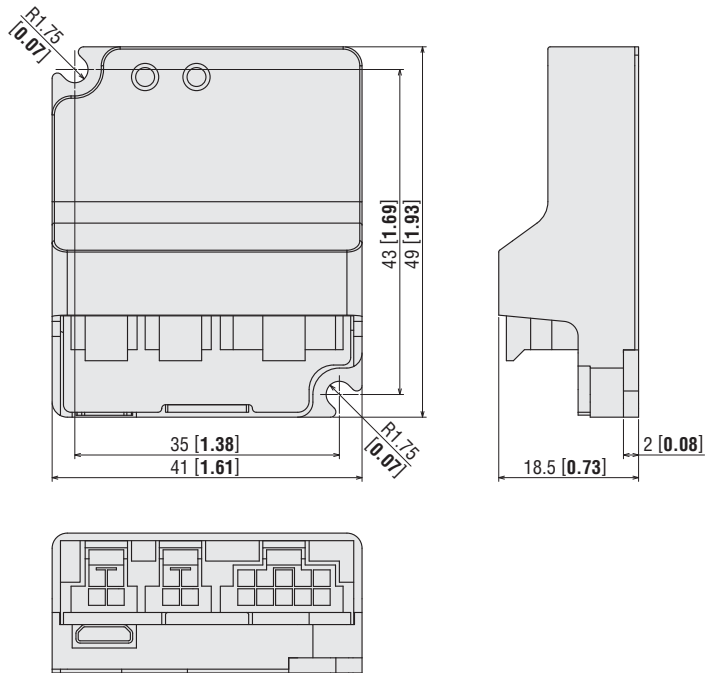

# AZ Series DC Input Direct Coupling Motor for Compact Drivers

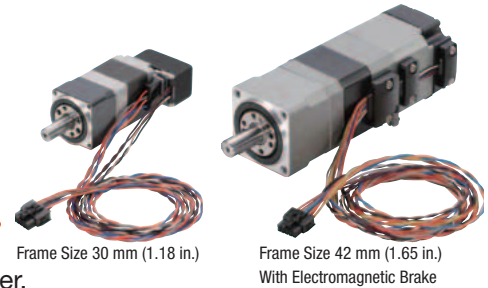

This is a lead wire type motor that can connect directly to the compact driver.

## Features

Can Connect Directly to AZ Compact Drivers

Improved Cable Routing

Space Saving

Reduced Size and Weight

## Product Number

### Motor

◇ Harmonic Geared Type

**AZM 2 4 A K W - HS 100**

① ② ③ ④ ⑤ ⑥ ⑦ ⑧

①	Motor Type	<b>AZM: AZ</b> Series Motor
②	Motor Frame Size	<b>2:</b> 30 mm (1.18 in.) <b>4:</b> 42 mm (1.65 in.)
③	Motor Case Length	
④	Output Shaft Type	<b>A:</b> Single Shaft <b>M:</b> Type with an Electromagnetic Brake
⑤	Motor Type	<b>K:</b> DC Input Specifications
⑥	Motor Cable Type	<b>W:</b> Separated Lead Wires
⑦	Geared Type	<b>H:</b> Harmonic Geared Type
⑧	Gear Ratio	

## Product Line

### Motor

◇ Harmonic Geared Type

Frame Size	Product Name	List Price
30 mm (1.18 in.)	<b>AZM24AKW-HS50</b>	\$877.00
	<b>AZM24AKW-HS100</b>	

◇ Harmonic Geared Type with Electromagnetic Brake

Frame Size	Product Name	List Price
42 mm (1.65 in.)	<b>AZM46MKW-HS50</b>	\$1,078.00
	<b>AZM46MKW-HS100</b>	

## Specifications



Motor Product Name	Single Shaft	<b>AZM24AKW-HS50</b>	<b>AZM24AKW-HS100</b>	—	—
	With Electromagnetic Brake	—	—	<b>AZM46MKW-HS50</b>	<b>AZM46MKW-HS100</b>
Driver Product Name	<b>AZ Series Compact Driver</b>				
<b>AZD-KRD</b>					
Max. Holding Torque	N·m (lb·in)	1.8 (15.9)	2.4 (21.2)	3.5 (31)	5 (44.3)
Rotor Inertia	J: kg·m <sup>2</sup>	12×10 <sup>-7</sup> (0.066)		88×10 <sup>-7</sup> (0.48)	
Gear Ratio		50	100	50	100
Resolution	Resolution setting: 1000 P/R	0.0072°/Pulse	0.0036°/Pulse	0.0072°/Pulse	0.0036°/Pulse
Permissible Torque	N·m (lb·in)	1.8 (15.9)	2.4 (21.2)	3.5 (31)	5 (44.3)
Maximum Instantaneous Torque*	N·m (lb·in)	3.3 (29.2)	4.8 (42.5)	8.3 (73.5)	11 (97.4)
Holding Torque at Motor Standstill	Power ON	N·m (lb·in)	2.4 (21.2)	3.5 (31)	5 (44.3)
	Electromagnetic Brake	N·m (lb·in)	—	3.5 (31)	5 (44.3)
Speed Range	r/min	0~70	0~35	0~70	0~35
Lost Motion (Load Torque)	arcmin	1.5 max.	1.5 max.	1.5 max.	1.5 max.
	N·m (oz·in)	±0.09 N·m (12.7)	±0.12 N·m (17)	±0.16 N·m (22.7)	±0.20 N·m (28.3)
Power Supply Input	Voltage	24 VDC±5%		24 VDC±5% / 48 VDC±5%	
	Input Current	A	1.4	1.6	

\*For the geared motor output torque, refer to the speed-torque characteristics.

### Note

● The rotor inertia represents a sum of the inertia of the harmonic gear converted to motor shaft values.

## Speed – Torque Characteristics (Reference values)

**AZM24 Gear Ratio 50**

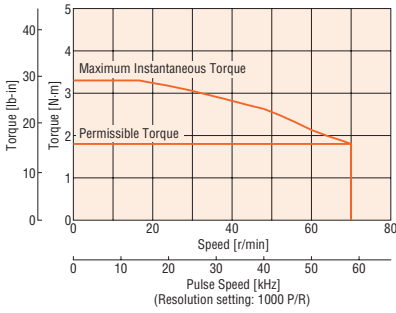

**AZM24 Gear Ratio 100**

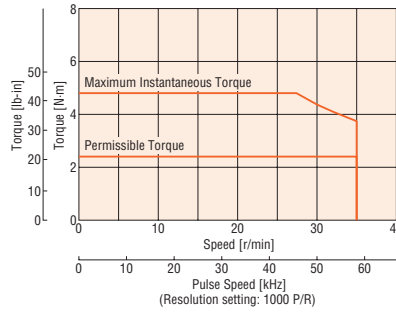

**AZM46 Gear Ratio 50**

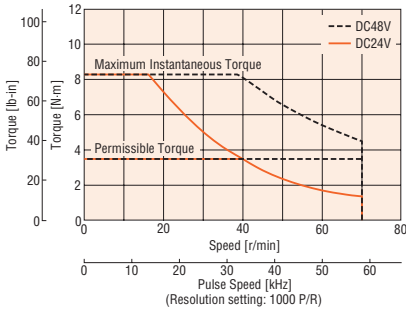

**AZM46 Gear Ratio 100**

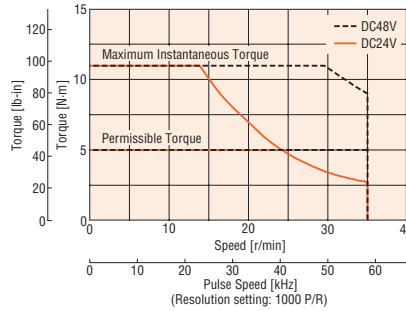

**Note**

- Data for the speed – torque characteristics is based on Oriental Motor's internal measurement conditions. If the conditions are changed, the characteristics may also change as a result.
- Depending on the driving conditions, a considerable amount of heat may be generated by the motor. To protect the absolute sensor, be sure to keep the temperature of the motor case at 80°C or less.

## General Specifications

		Motor
Thermal Class		130 (B)
Insulation Resistance		100 MΩ or more when a 500 VDC megger is applied between the following places: <ul style="list-style-type: none"> <li>• Case and Motor Windings</li> <li>• Case and Electromagnetic Brake Windings*</li> </ul>
Dielectric Strength		Sufficient to withstand the following for 1 minute: <p><b>AZM24</b></p> <ul style="list-style-type: none"> <li>• Case and Motor Windings 0.5 kVAC 50Hz or 60Hz</li> </ul> <p><b>AZM46</b></p> <ul style="list-style-type: none"> <li>• Case and Motor Windings 1.0 kVAC 50Hz or 60Hz</li> <li>• Case and Electromagnetic Brake Windings 1.0 kVAC 50Hz or 60Hz</li> </ul>
Operating Environment (In operation)	Ambient Temperature	0 to +40°C (32~104°F) (Non-freezing)
	Ambient Humidity	85% or less (Non-condensing)
	Atmosphere	Use in an area without corrosive gases and dust. The product should not be exposed to water, oil or other liquids.
Degree of Protection		<b>AZM24:</b> IP40 (excluding installation surfaces and connector locations) <b>AZM46:</b> IP20 (excluding installation surfaces and connector locations)
Multiple Rotation Detection Range in Power OFF State		<b>AZM24:</b> ±450 rotations (900 rotations) <b>AZM46:</b> ±900 rotations (1800 rotations)

\*Only for types with an electromagnetic brake

**Note**

- When measuring insulation resistance, or performing dielectric strength testing, ensure that the motor and driver are disconnected. Also, do not perform these tests on the absolute sensor (ABZ0) part of the motor.

## Electromagnetic Brake Specifications

Product Name	<b>AZM46</b>	
Type	Power Off Activated Type	
Power Supply Voltage	24 VDC ±5%	
Power Supply Current	A	0.08
Brake Activation Time	ms	20
Brake Release Time	ms	30
Time Rating	Continuous	

## Dimensions Unit = mm (in.)

### ◇ Harmonic Geared Type

Frame Size 30 mm (1.18 in.)

2D & 3D CAD

Product Name	Gear Ratio	Mass kg (lb)	2D CAD
<b>AZM24AKW-HS</b>	<b>50, 100</b>	0.24 (0.53)	B1497

● A number indicating the gear ratio is specified where the box ■ is located in the product name.

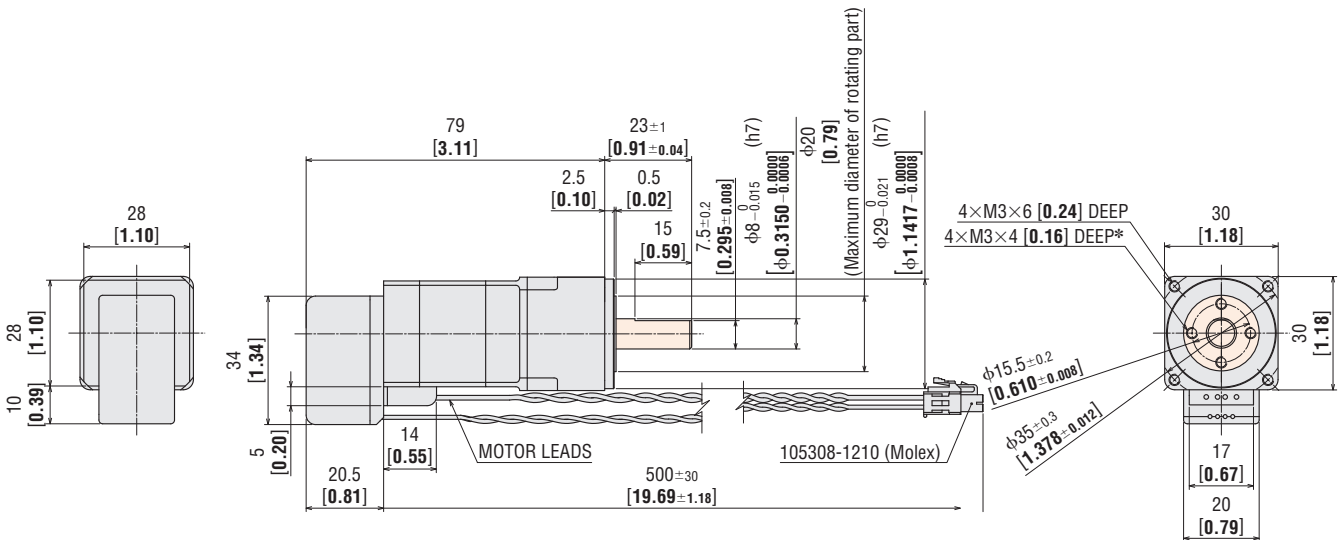

\*The position of the output shaft relative to the screw holes on the rotating part cannot be specified. Adjust the position via the size of the screw holes on the load installation surface.

● The shaded areas in the dimensions are rotating parts.

### ◇ Harmonic Geared Type with Electromagnetic Brake

Frame Size 42 mm (1.65 in.)

2D & 3D CAD

Product Name	Gear Ratio	Mass kg (lb)	2D CAD
<b>AZM46MKW-HS</b>	<b>50, 100</b>	0.73 (1.61)	B1503

● A number indicating the gear ratio is specified where the box ■ is located in the product name.

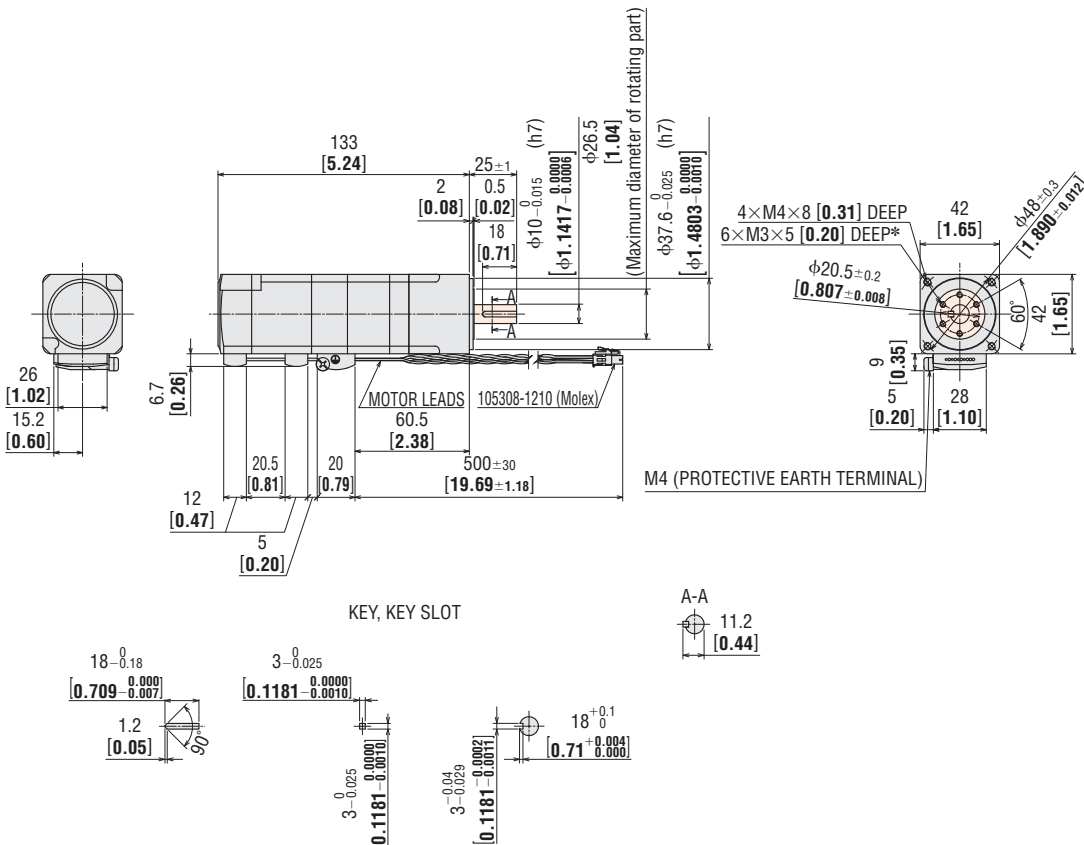

\*The position of the output shaft relative to the screw holes on the rotating part cannot be specified. Adjust the position via the size of the screw holes on the load installation surface.

● The shaded areas in the dimensions are rotating parts.

# AZ Series DC Input Cables for Compact Drivers

## Connection Cables and Power Supply/Communication Cables

These cables feature separated lead wires which improves the ease of cable routing and contributes to both weight and space saving on the equipment.

### ① Connection Cables

For connection between motor and driver  
See below for motor frame size details.

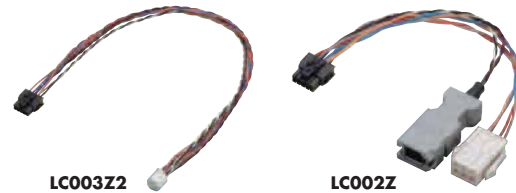

### ② Power Supply/Communication Cables

For connection to host system and DC power supply  
Length: 1 m [3.3 ft.], 2 m [6.6 ft.]

These are leads with a connector connection on the driver side and bare wires on the other side.



### ③ Power Supply/Communication Cables

For driver connection

Length: 0.5 m [1.6 ft.]

Daisy-chain connection of multiple drivers is possible.  
These are leads with connectors at both ends.

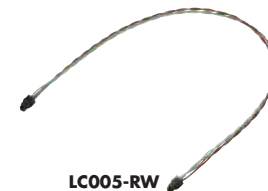

## Product Line

	Cable Type	Product Name	Length m (ft.)	List Price
① Connection Cables	For □42 mm [1.65 in.] / □60 mm [2.36 in.]	<b>LC002Z</b>	0.2 (0.7)	\$23.00
	For □42 mm [1.65 in.] / □60 mm [2.36 in.] Type with Electromagnetic Brake	<b>LC002ZB</b>	0.2 (0.7)	\$29.00
	For □20 mm [0.79 in.] / □28 mm [1.10 in.]	<b>LC003Z2</b>	0.35 (1.1)	\$23.00
② Power Supply/Communication Cables	For Host System, DC Power Supply Connection	<b>LC010-RS</b>	1 (3.3)	\$14.00
		<b>LC020-RS</b>	2 (6.6)	\$17.00
③ Power Supply/Communication Cables	For Driver Connection	<b>LC005-RW</b>	0.5 (1.6)	\$14.00

Specifications are subject to change without notice. This catalog was published in August, 2020.

## **ORIENTAL MOTOR U.S.A. CORP.**

### **Western Sales and Customer Service Center**

Tel: (310) 715-3301 Fax: (310) 225-2594

#### **Los Angeles**

Tel: (310) 715-3301

#### **San Jose**

Tel: (408) 392-9735

### **Midwest Sales and Customer Service Center**

Tel: (847) 871-5900 Fax: (847) 472-2623

#### **Chicago**

Tel: (847) 871-5900

#### **Detroit**

Tel: (734) 808-0003

#### **Dallas**

Tel: (214) 432-3386

#### **Toronto**

Tel: (905) 502-5333

### **Eastern Sales and Customer Service Center**

Tel: (781) 848-2426 Fax: (781) 848-2617

#### **Boston**

Tel: (781) 848-2426

#### **Charlotte**

Tel: (704) 766-1335

#### **New York**

Tel: (973) 359-1100

### **Technical Support**

Tel: (800) 468-3982 / 8:30 A.M. to 5:00 P.M., P.S.T. (M-F)  
7:30 A.M. to 5:00 P.M., C.S.T. (M-F)

E-mail: [techsupport@orientalmotor.com](mailto:techsupport@orientalmotor.com)

**Obtain Specifications, Online Training  
and Purchase Products at:  
[www.orientalmotor.com](http://www.orientalmotor.com)**

Copyright ©2020 ORIENTAL MOTOR U.S.A. CORP.

This printed material uses ECF (Elemental  
Chlorine Free) paper and vegetable oil based inks.  
This combination is environmentally friendly.