

DETAIL OF OUTPUT SHAFT

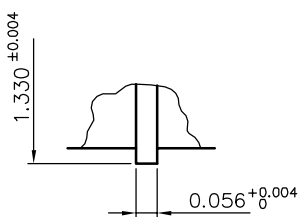

DETAIL OF : A

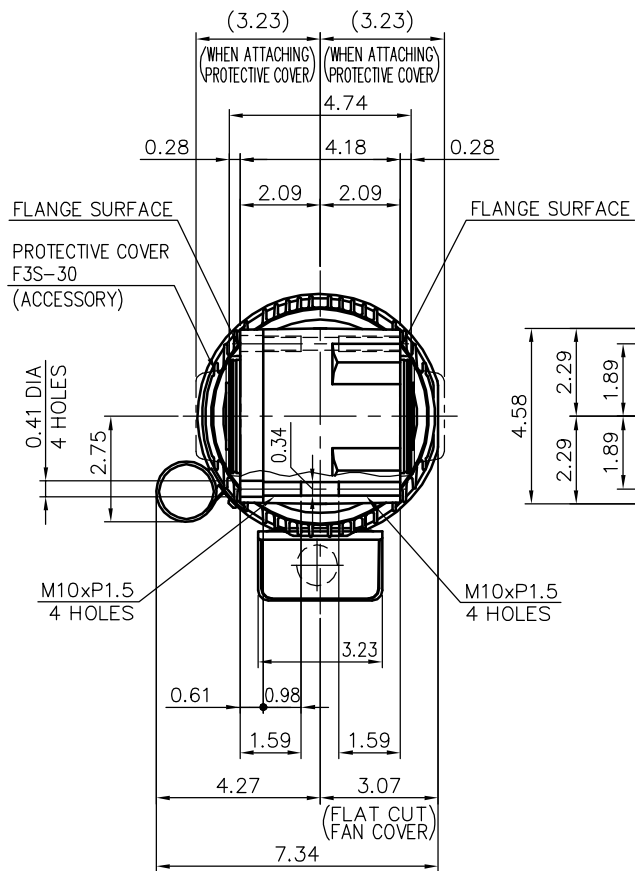

MOTOR SPECIFICATION

TYPE	1-PHASE INDUCTION MOTOR
FORM	TOTALLY ENCLOSED FAN COOLED TECA13
OUT PUT	1/2 HP
VOLTAGE	220 V
FREQ	50/60 Hz
POLES	4
RATING	CONT.

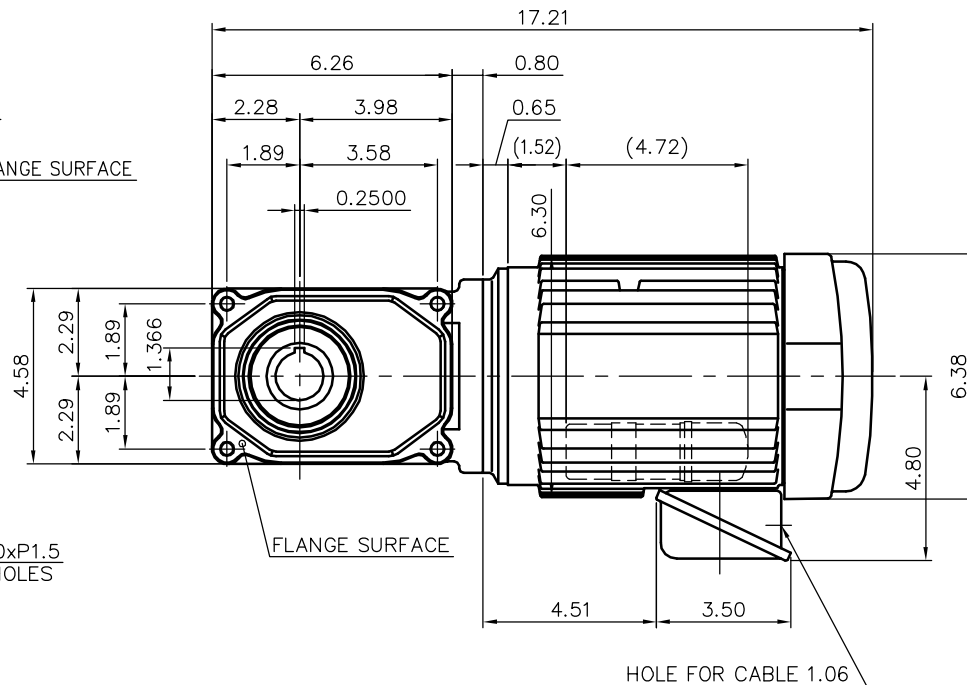

REDUCER SPECIFICATION

TYPE	GTR
FORM	30
RATIO	1/5 1/7.5 1/10 1/12.5 1/15 1/20 1/25 1/30 1/40 1/50 1/60
LUBRICATION	GREASE

NOTE: THIS MOTOR IS AFFIXED WITH CE MARKING.
 NOTE: BE SURE TO USE THE THERMAL RELAY WITH CE MARKING.
 NOTE: THE GROUND LEAD SHOULD BE LONGER THAN THE SUPPLY LEAD FOR THE MOTOR.
 NOTE: INSULATION : CLASS A
 NOTE: THIS MOTOR IS UL CERTIFIED MODEL.(UL1004)
 NOTE: UL-LISTED MODEL NAME: BML5S

TITLE F3S30N005~060-BML5S DIMENSION OF MODEL					
DRAWING NO. F3S30N-BML5S					
USER					
NOTICE					
APPROVE	K.Nagasaka	SCALE	1/5	UNIT in	DATE 2008.02.05
CHECK	Y.Shiina				
DESIGN	M.Yoshida				
			NISSEI CORPORATION		