

REVISIONS

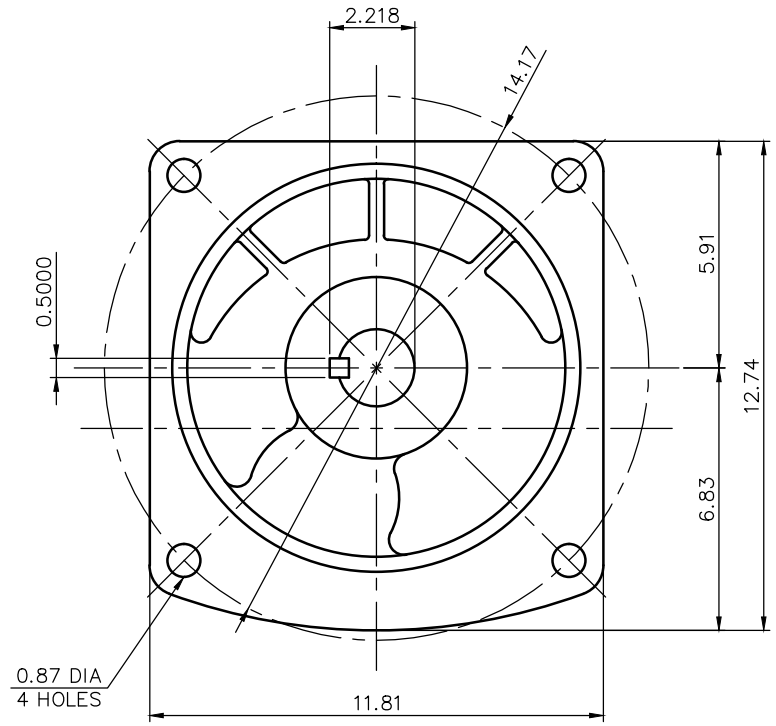
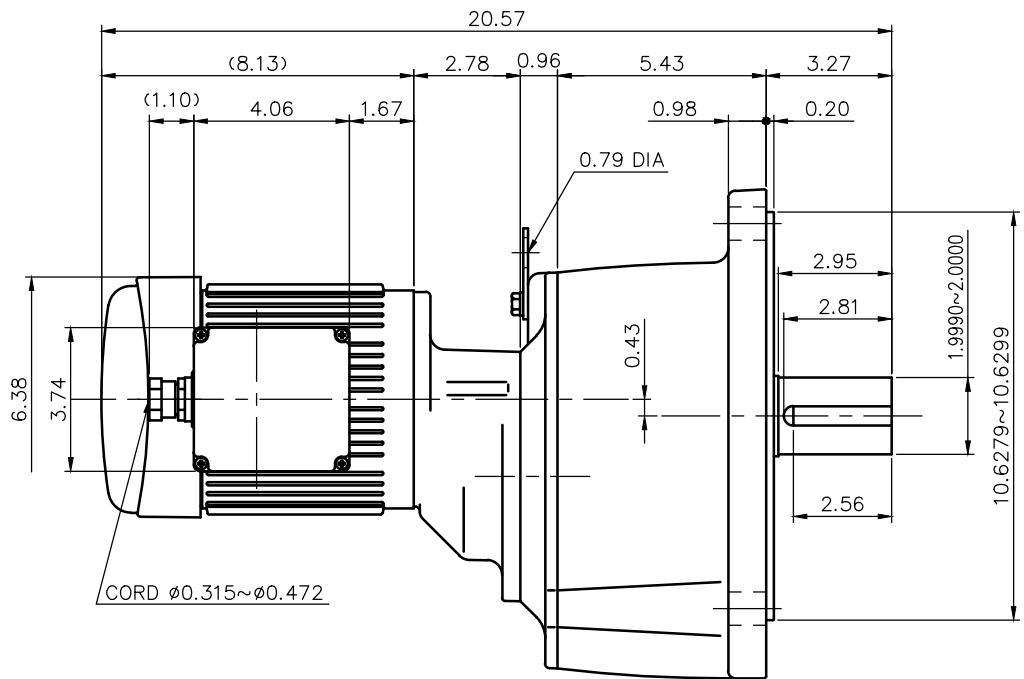

NOTE: THE ATTACHED RECTIFIER IS USED FOR DC POWER SUPPLY TO THE BRAKE COIL.
 NOTE: THE BRAKE LEADS ARE PULLED INTO THE TERMINAL BOX.

NOTE: THIS MOTOR IS AFFIXED WITH CE MARKING.
 NOTE: THE GROUND LEAD SHOULD BE LONGER THAN THE SUPPLY LEAD FOR THE MOTOR.
 NOTE: THIS MOTOR IS UL CERTIFIED MODEL.(UL1004-1)
 NOTE: UL-LISTED MODEL NAME: MF5AWB4

BRAKE SPECIFICATION

TYPE	BS3-08U-180
BRAKE TYPE	SPRING CLOSE
INPUT VOLTAGE	DC 207V
POWER CONSUMPTION	34 W (at 75°C)
BRAKE TORQUE	52.0 in-lbs

MOTOR SPECIFICATION

TYPE	3-PHASE INDUCTION MOTOR
FORM	TOTALLY ENCLOSED FAN COOLED
OUT PUT	3/4 HP
VOLTAGE	208/230/460/400 V
FREQ.	60/60/60/50 Hz
POLES	4
ROTATIONAL FREQUENCY	1800/1800/1800/1500 rpm
RATING	S1 CONT.
INS.CLASS	F

REDUCER SPECIFICATION

TYPE	GTR
FORM	50
RATIO	1/300 1/375 1/450
LUBRICATION	GREASE

TITLE G3F50N300~450-MF5AWB4					
DIMENSION OF MODEL					
DRAWING NO. G3F50N-MF5AWB4					
USER					
NOTICE					
APPROVE	Y.Ikeda	SCALE	1/5	UNIT in	DATE 2016.10.16
CHECK	Y.Sanji				
DESIGN	A.Kubota				
NISSEI CORPORATION					