

REVISIONS

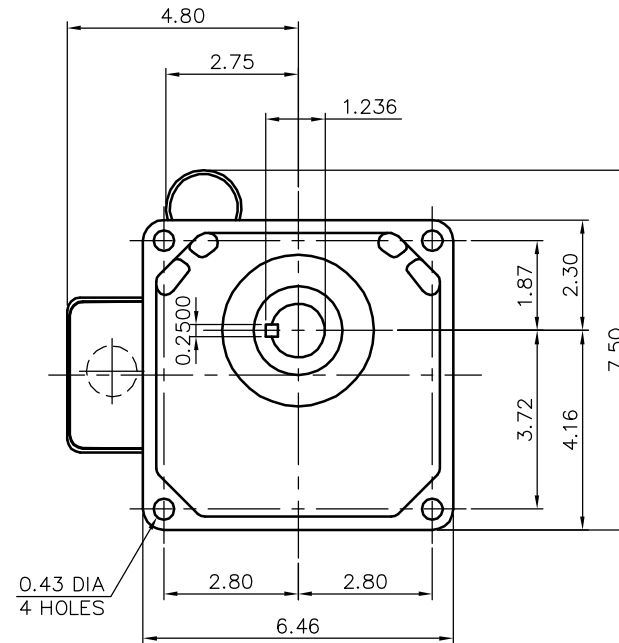
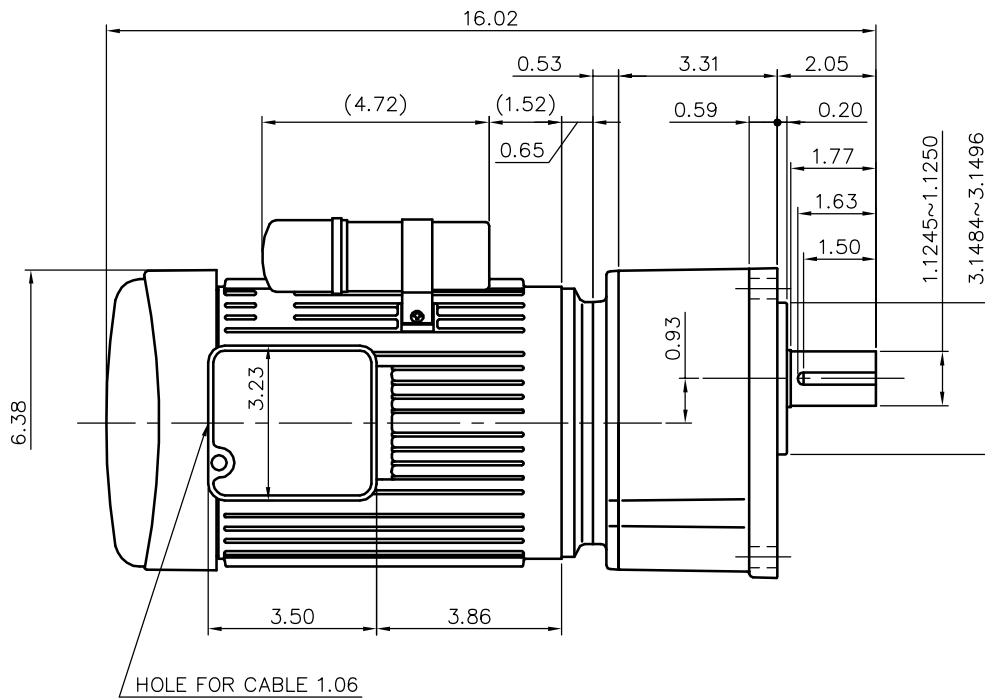

MOTOR SPECIFICATION

TYPE	1-PHASE INDUCTION MOTOR
FORM	TOTALLY ENCLOSED FAN COOLED TECA13
OUT PUT	1/2 HP
VOLTAGE	230 V
FREQ	50/60 Hz
POLES	4
RATING	CONT.

REDUCER SPECIFICATION

TYPE	GTR
FORM	28
RATIO	1/30 1/40 1/50 1/60 1/80
LUBRICATION	GREASE

NOTE: THIS MOTOR IS AFFIXED WITH CE MARKING.
 NOTE: BE SURE TO USE THE THERMAL RELAY WITH CE MARKING.
 NOTE: THE GROUND LEAD SHOULD BE LONGER THAN THE SUPPLY LEAD FOR THE MOTOR.
 NOTE: INSULATION : CLASS A
 NOTE: THIS MOTOR IS UL CERTIFIED MODEL.(UL1004)
 NOTE: UL-LISTED MODEL NAME: BML6S

TITLE G3K28N030~080-BML6S DIMENSION OF MODEL					
DRAWING NO. G3K28N-BML6S					
USER					
NOTICE					
APPROVE	K.Nagasaka	SCALE	1/4	UNIT in	DATE 2008.01.09
CHECK	Y.Shiina				
DESIGN	M.Yoshida				
NISSEI CORPORATION					