

REVISIONS

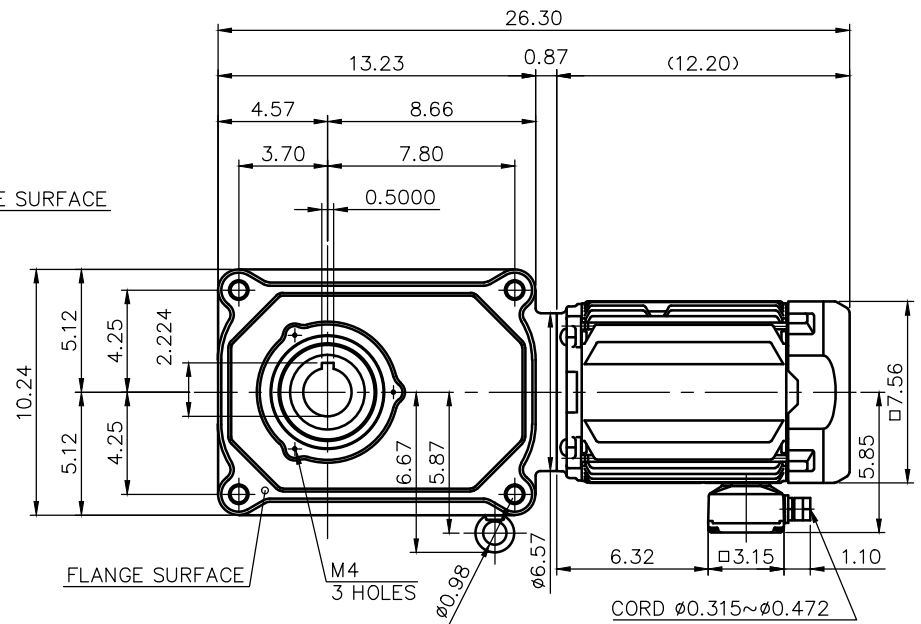
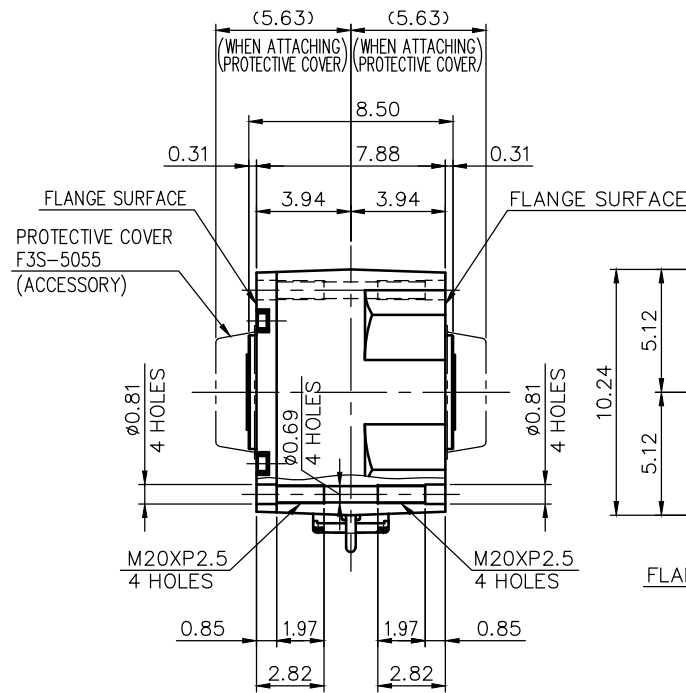
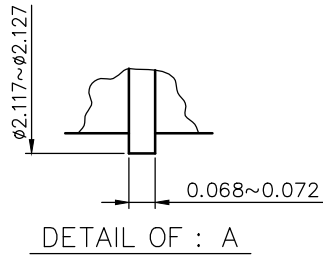
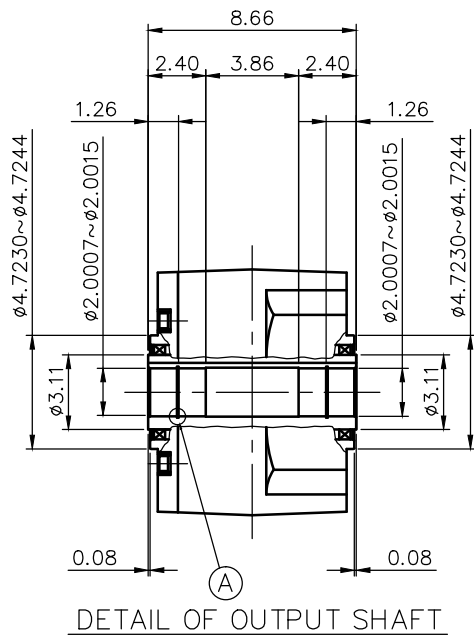

MOTOR SPECIFICATION

TYPE	3-PHASE INDUCTION MOTOR
FORM	TOTALLY ENCLOSED FAN COOLED P9
OUT PUT	3 HP
VOLTAGE	208/230/460/400 V
FREQ.	60/60/60/50 Hz
POLES	4
ROTATIONAL FREQUENCY	1800/1800/1800/1500 rpm
EFFICIENCY CLASS	IE3 EN60034-30 Standard
RATING	S1 CONT.
INS.CLASS	F

REDUCER SPECIFICATION

TYPE	GTR
FORM	55
RATIO	1/80 1/100 1/120
LUBRICATION	GREASE

NOTE: FIX THE PROTECTIVE COVER (ACCESSORY)
ON M4 (3 HOLES) USE ROUND-HEAD SCREWS
(ACCESSORY,3PCE)
NOTE: THIS MOTOR IS AFFIXED WITH CE MARKING.
NOTE: THE GROUND LEAD SHOULD BE LONGER THAN
THE SUPPLY LEAD FOR THE MOTOR.
NOTE: THIS MOTOR IS UL CERTIFIED MODEL. (UL1004-1)
NOTE: UL-LISTED MODEL NAME: MV9AEN

TITLE		F3S55N80~120-MV9AEN DIMENSION OF MODEL			
DRAWING NO.		F3S55N-MV9AEN			
USER					
NOTICE					
APPROVE	Y.Ikeda	SCALE	1/8	UNIT in	DATE 2015.05.01
CHECK	M.Iijima				
DESIGN	Y.Miura				
NISSEI CORPORATION					