

REVISIONS

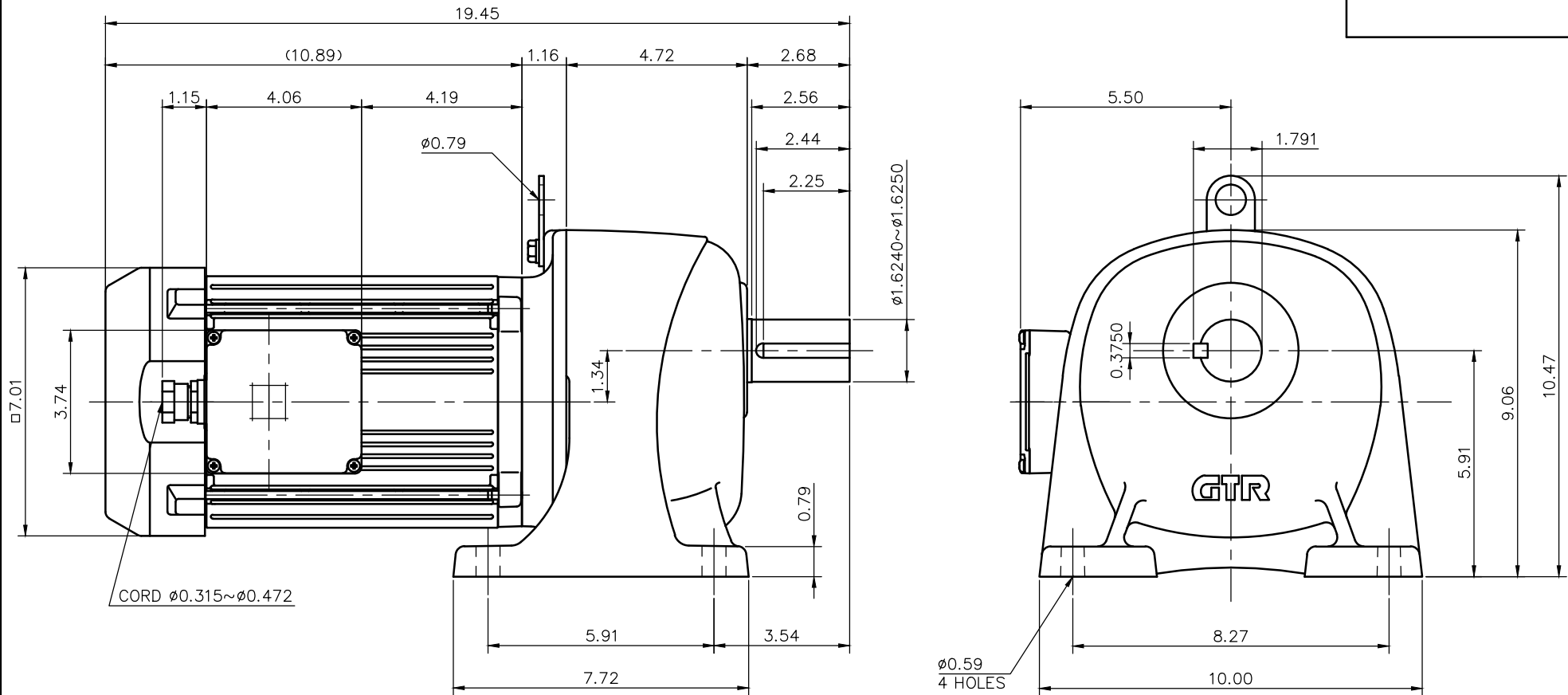

NOTE: THE RATING OF ENCLOSURE CLASS:

IP65 (EN60034-5) EQUIVALENT.

NOTE: OUTPUT SHAFT AND KEY MATERIAL: SUS420J2

NOTE: COMPLIANCE CERTIFICATION NUMBER: CC303B

NOTE: THIS MOTOR IS AFFIXED WITH CE MARKING.

NOTE: THE GROUND LEAD SHOULD BE LONGER THAN THE SUPPLY LEAD FOR THE MOTOR.

NOTE: THIS MOTOR IS UL CERTIFIED MODEL. (UL1004-1)

NOTE: UL-LISTED MODEL NAME: WV8AWN

MOTOR SPECIFICATION

TYPE	3-PHASE INDUCTION MOTOR
FORM	TOTALLY ENCLOSED FAN COOLED P8
OUT PUT	2 HP
VOLTAGE	208/230/460/400 V
FREQ.	60/60/60/50 Hz
POLES	4
ROTATIONAL FREQUENCY	1800/1800/1800/1500 rpm
EFFICIENCY CLASS	IE3 EN60034-30 Standard
RATING	S1 CONT.
INS.CLASS	F

REDUCER SPECIFICATION

TYPE	GTR
FORM	40
RATIO	1/30 1/40 1/50 1/60
LUBRICATION	GREASE

TITLE		G3L40S30~100-WV8AWN			
DRAWING NO.		G3L40S-WV8AWN			
USER					
NOTICE					
APPROVE	Y.Ikeda	SCALE	1/4	UNIT in	DATE 2016.04.01
CHECK	M.Iijima				
DESIGN	Y.Miura				
NISSEI CORPORATION					