

REVISIONS

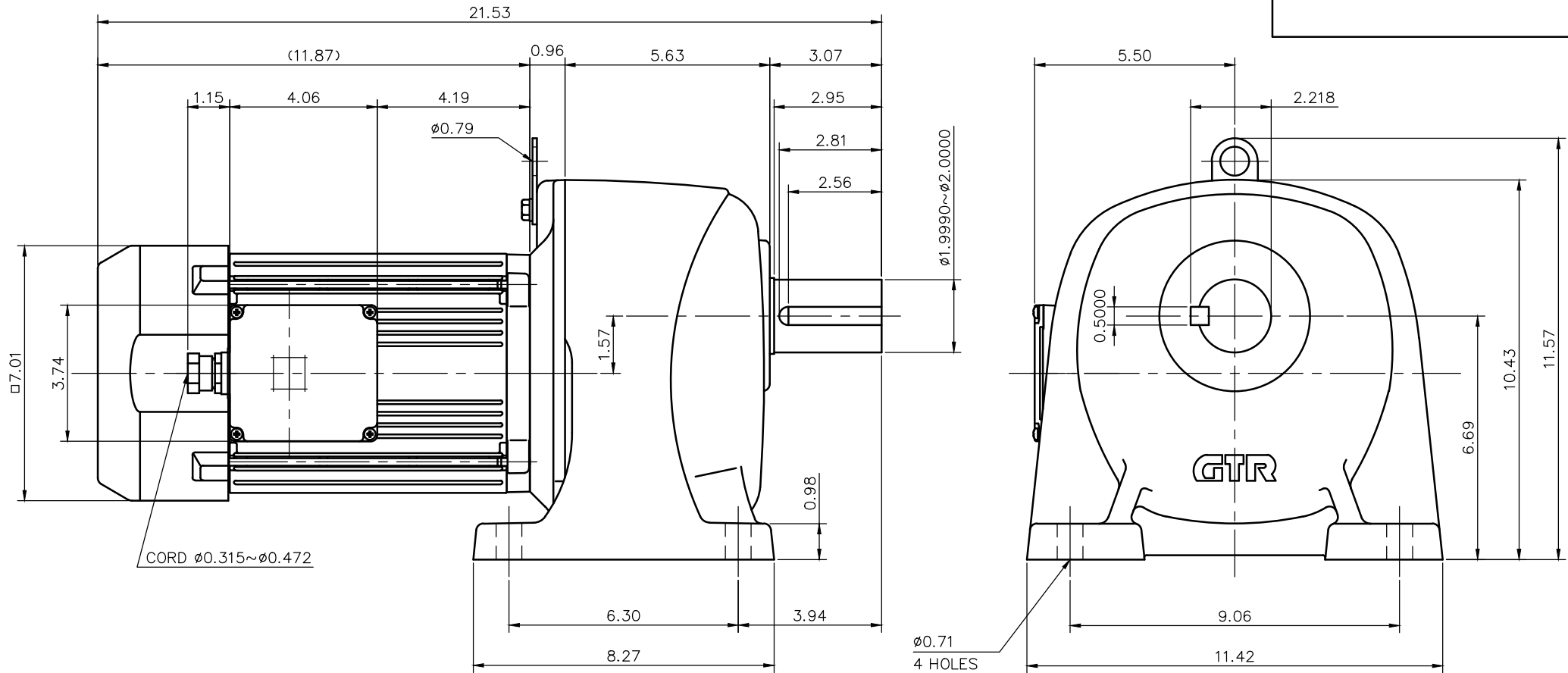

NOTE: THE BRAKE LEADS ARE PULLED INTO THE TERMINAL BOX.
 NOTE: THE ATTACHED RECTIFIER IS USED FOR DC POWER SUPPLY TO THE BRAKE COIL.

NOTE: COMPLIANCE CERTIFICATION NUMBER: CC303B
 NOTE: THIS MOTOR IS AFFIXED WITH CE MARKING.
 NOTE: THE GROUND LEAD SHOULD BE LONGER THAN THE SUPPLY LEAD FOR THE MOTOR.
 NOTE: THIS MOTOR IS UL CERTIFIED MODEL. (UL1004-1)
 NOTE: UL-LISTED MODEL NAME: MV8AWB4

BRAKE SPECIFICATION

TYPE	BS3-15-180
BRAKE TYPE	SPRING CLOSE
INPUT VOLTAGE	DC 207V
POWER CONSUMPTION	49 W (at 75 °C)
BRAKE TORQUE	104.1 in-lbs

MOTOR SPECIFICATION

TYPE	3-PHASE INDUCTION MOTOR
FORM	TOTALLY ENCLOSED FAN COOLED P8
OUT PUT	2 HP
VOLTAGE	208/230/460/400 V
FREQ.	60/60/60/50 Hz
POLES	4
ROTATIONAL FREQUENCY	1800/1800/1800/1500 rpm
EFFICIENCY CLASS	IE3 EN60034-30 Standard
RATING	S1 CONT.
INS.CLASS	F

REDUCER SPECIFICATION

TYPE	GTR
FORM	50
RATIO	1/100 1/120 1/160
LUBRICATION	GREASE

TITLE G3L50N100~200-MV8AWB4
 DIMENSION OF MODEL

DRAWING NO. G3L50N-MV8AWB4

USER

NOTICE

APPROVE	Y.Ikeda	SCALE	1/4		UNIT	DATE
CHECK	M.Iijima				in	2016.04.01
DESIGN	Y.Miura				NISSEI CORPORATION	