



OPERATING MANUAL

Brushless Motors

BLE2 Series



Thank you for purchasing an Oriental Motor product. This Operating Manual describes product handling procedures and safety precautions.

- Please read the operating manual thoroughly to ensure safe operation.
- Always keep the manual where it is readily available.
- Only qualified personnel should work with the product.
- The product described in this manual has been designed and manufactured to be incorporated in general industrial equipment. Do not use for any other purpose. Oriental Motor Co., Ltd. is not responsible for any damage caused through failure to observe this warning.

Safety precautions

Be sure to read before using the product. Use the product correctly after thoroughly reading this section.

Safety precautions

Preparation

Precautions for use	6
System Configuration	8
Checking the product	9
Installing	12
Connecting	14

Preparation

How to use

Operating	30
Convenient functions	41
Operation panel	42
Parameter	50
Setting and monitor by the MEXE02	60

How to use

Reference

Maintenance and inspection	68
Troubleshooting	69
Alarms	70
Information	72

Reference

Appendix

Specifications	74
Regulations and standards	76
Accessories	79

Appendix

Table of contents

Safety precautions.....4

Be sure to read before using the product.
Use the product correctly after thoroughly reading
this section.



Preparation

Precautions for use 6

System Configuration 8

Checking the product 9

1. Package contents..... 9
2. How to identify the product model 9
3. Products possible to combine..... 10
4. Names and functions of parts 11

Installing 12

1. Installation location 12
2. Installation method..... 12

Connecting 14

1. Connecting the power supply (CN1) 14
2. Connecting the motor and driver 15
- * 3. Grounding 16
4. Connecting the I/O signals (CN5)..... 17
5. Connecting external analog setting devices 18
6. Connecting the USB cable 18
7. Connecting the regeneration resistor 19
 - 7-1 Connection method 19
 - 7-2 Regeneration resistor specifications..... 19
8. Connection diagram 20
9. I/O signals 24
 - 9-1 I/O signals list 24
 - 9-2 Overview of I/O signals..... 25
 - 9-3 Descriptions of input signals 26
 - 9-4 Descriptions of output signals 28



How to use

Operating 30

1. Operation using the operation panel.....30
2. Operation using the external signals.....31
 - 2-1 Overview.....31
 - 2-2 Setting method of the rotation speed ...31
 - 2-3 Procedures to set the rotation speed31
 - 2-4 Operation/standstill using external signals33
 - 2-5 Examples of operation patterns33
 - 2-6 Gain adjustment and offset adjustment for rotation speed34
3. Setting of torque limiting35
 - 3-1 Gain adjustment and offset adjustment for torque limiting value36
4. Setting of acceleration/deceleration time ...37
5. Setting of the rotation direction.....38
6. Operating in two or more speeds (multi-speed operation)38
7. Adjusting the rotation speed of two or more motors by a single setting device (multi-motor control).....40

Convenient functions 41

Operation panel 42

1. Operation panel42
 - 1-1 Names and functions of parts42
 - 1-2 How to read the display42
 - 1-3 Function mode types43
2. Operation transitions.....44
 - 2-1 Items which can be monitored.....44
 - 2-2 Setting the operation data46
 - 2-3 Setting the parameters.....47
 - 2-4 Test mode48
3. Edit lock function49

* Be sure to ground the protective earth terminal (⊕) (ground terminal) to ensure the safe use of the product.

Refer to "3 Grounding" for details, and ground securely.

Parameter 50

1. Parameter list.....50
2. Timing for parameter to become effective...52
3. Explanation of parameters52
 - 3-1 Basic setting parameters.....52
 - 3-2 Speed, torque limiting command selection parameter54
 - 3-3 Alarm, Information setting parameters55
 - 3-4 Operation setting parameters.....57
 - 3-5 I/O action parameters58
 - 3-6 I/O function selection parameters.....59
 - 3-7 I/O function parameters.....59

Setting and monitor by the MEXE02 60

1. Setting the data60
2. Setting the parameters60
3. Monitor61
4. Teaching, remote operation.....66

Reference

Maintenance and inspection...68

1. Inspection.....68
2. Warranty.....68
3. Disposal.....68

Troubleshooting 69

Alarms..... 70

1. Alarm reset70
2. Alarm records70
3. Alarm lists70

Information 72

1. Information records72
2. Information lists.....72

Appendix

Specifications 74

1. Specifications74
2. General specifications75
3. Pin assignment.....75

Regulations and standards...76

1. UL Standards and CSA Standards76
2. EU Directive.....76
3. Republic of Korea, Radio Waves Act.....76
4. RoHS Directive76
5. Installing and wiring in compliance with EMC Directive77

Accessories 79

Safety precautions

The precautions described below are intended to prevent danger or injury to the user and other personnel through safe, correct use of the product. Use the product only after carefully reading and fully understanding these instructions.

 **Warning** Handling the product without observing the instructions that accompany a "Warning" symbol may result in serious injury or death.

 **Caution** Handling the product without observing the instructions that accompany a "Caution" symbol may result in injury or property damage.

 **Note** The items under this heading contain important handling instructions that the user should observe to ensure the safe use of the product.

Description of graphic symbols

 Indicates "prohibited" actions that must not be performed.





 Indicates "compulsory" actions that must be performed.

Warning

Operating environment

	Do not use the product in explosive or corrosive environments, in the presence of flammable gases or near combustibles.	Doing so may result in fire, electric shock or injury.
-----------------------------------------------------------------------------------	-------------------------------------------------------------------------------------------------------------------------	--------------------------------------------------------



Handling of this product

	Do not transport, install, connect or inspect the product while the power is supplied. Always turn the power off before carrying out these operations.	Doing so may result in electric shock or damage to equipment.
	The terminals on the driver front panel marked with   symbol indicate the presence of high voltage. Do not touch these terminals while the power is on.	Doing so may result in fire or electric shock.
	Do not use a motor in a vertical application. If the driver protective function is activated, the motor will stop and the moving part of the equipment may drop.	This may cause injury or damage to equipment.
	Only qualified and educated personnel should be allowed to perform installation, connection, operation and inspection/troubleshooting of the product.	Handling by unqualified and uneducated personnel may result in fire, electric shock, injury or equipment damage.
	If the driver protective function was activated, remove the cause and reset the protective function. Continuing the operation without removing the cause of the problem may cause malfunction of the motor and driver, leading to injury or damage to equipment.	This may cause injury or damage to equipment.

Installation

	The motor and driver are Class I equipment. When installing the motor and driver, connect their Protective Earth Terminals.	Failure to do so may result in electric shock.
-------------------------------------------------------------------------------------	-----------------------------------------------------------------------------------------------------------------------------	------------------------------------------------



Connection

	Do not machine or modify the connection cable.	Doing so may result in fire, electric shock or damage to equipment.
	Do not apply any excessive force to the motor connector.	
	Do not forcibly bend, pull or pinch the cable.	
	Do not remove the connector cap until the connection cable is connected so that the O-ring of the connector connection on the motor is not damaged.	
	Securely connect and ground in accordance with the wiring diagram.	Failure to do so may result in fire, electric shock or damage to equipment.
	Be sure to observe the specified cable sizes.	

Operation

	Always keep the power supply voltage of the driver within the specified range.	Failure to do so may result in fire or electric shock.
	Use a motor, gearhead, and driver only in the specified combination.	Failure to do so may result in fire, electric shock or damage to equipment.

Maintenance and inspection

	Do not touch the motor or driver when conducting the insulation resistance measurement or dielectric strength test.	Accidental contact may result in electric shock.
	Do not touch the connection terminals on the driver immediately (until the CHARGE LED turns off) after the power is turned off.	Residual voltage may cause electric shock.
	Always turn off the power before performing maintenance/inspection.	Failure to do so may result in electric shock.
	Regularly check the openings in the driver for accumulated dust.	Accumulated dust may cause fire.

Repair, disassembly and modification



	Do not disassemble or modify the motor, gearhead, and driver. Refer all such internal inspections and repairs to the branch or sales office from which you purchased the product.	Doing so may result in electric shock, injury or damage to equipment.
-----------------------------------------------------------------------------------	--------------------------------------------------------------------------------------------------------------------------------------------------------------------------------------	-----------------------------------------------------------------------

Caution

Handling of this product

	Do not use the motor, gearhead, driver, or regeneration resistor in a state where the specification value is exceeded.	Doing so may result in fire, electric shock, injury or damage to equipment.
	Do not insert an object into the openings in the driver.	Doing so may result in fire, electric shock or injury.
	Do not touch the motor, gearhead, driver, or regeneration resistor while operating or for a certain time after stopping.	The surface of the motor, gearhead, driver, or regeneration resistor may be hot, thereby causing a skin burn(s).



Installation

	Do not leave anything around the motor and driver that would obstruct ventilation.	Doing so may result in damage to equipment.
	Securely install the motor and gearhead, and the driver to their respective mounting plates.	Inappropriate installation may cause the motor/driver to detach and fall, resulting in injury or equipment damage.

Connection

	Be sure to ground the motor and driver to prevent them from being damaged by static electricity.	Failure to do so may result in fire or damage to equipment.
	For the power supply of I/O signals, use a DC power supply with reinforced insulation on its primary and secondary sides.	Failure to do so may result in electric shock.

Operation

	Do not touch the rotating part (output shaft) while operating the motor.	Doing so may result in injury.
	Provide an emergency stop device or emergency stop circuit external to the equipment so that the entire equipment will operate safely in the event of a system failure or malfunction.	Failure to do so may result in injury.
	Immediately when trouble has occurred, stop operation and turn off the driver power.	Failure to do so may result in fire, electrical shock or injury.
	The motor surface temperature may exceed 70 °C (158 °F) even under normal operating conditions. If the operator is allowed to approach the running motor, attach a warning label as shown in the right in a conspicuous position.	 Warning label

Warning information

A warning label with handling instructions is attached on the driver.
Be sure to observe the instructions on the label when handling the driver.

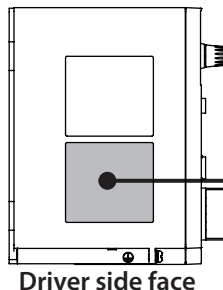

	WARNING – Risk of electric shock. Hot Surface
<ul style="list-style-type: none"> • Read manual before installing. • Do not touch the driver immediately after the power is cut off, or until the CHARGE LED (lit in red) turns off. • Doing so may result in electric shock due to residual voltage. • Do not touch the heatsink. Risk of burn. 	
	AVERTISSEMENT – Risque de décharge électrique. Surface chaude
<ul style="list-style-type: none"> • Lire le manuel avant l'installation. • Ne pas toucher au ventilateur immédiatement après la mise hors tension ou avant que la LED "présence de la tension" (Rouge) ne soit éteinte. Le non respect de ces règles pourrait entraîner un choc électrique. • Ne pas toucher le dissipateur thermique. Risque de brûlure. 	
	警告 告 高温注意
<ul style="list-style-type: none"> • 組み付け、運転の前には必ず取扱説明書をお読み下さい。 • 電源を切った直後、CHARGE LED (赤色点灯) が消灯するまでドライバに触れないで下さい。残留電圧により感電の原因となります。 • ヒートシンクは高温になります。やけどに注意して下さい。 	

Precautions for use

This chapter covers limitations and requirements the user should consider when using the product.

Be sure to match the motor output power with the driver output power.

Wirings

● Connect protective devices to the power line

Connect a circuit breaker or earth leakage breaker to the driver power line to protect the primary circuit.

If an earth leakage breaker is to be installed, use one incorporating high-frequency noise elimination measures. For selection of the protective device, refer to the following "Preventing leakage current."

● Noise elimination measures

Provide noise elimination measures to prevent a motor malfunction caused by external noise.

For more effective elimination of noise, use a shielded I/O signal cable or attach ferrite cores if a non-shielded cable is used. Refer to p.77 for the noise elimination measures.

● Preventing leakage current

Stray capacitance exists between the driver's current-carrying line and other current-carrying lines, the earth and the motor, respectively. A high-frequency current may leak out through such capacitance, having a detrimental effect on the surrounding equipment. The actual leakage current depends on the driver's switching frequency, the length of wiring between the driver and motor, and so on. When connecting an earth leakage breaker, use one of the following products offering resistance against high frequency current:

[Mitsubishi Electric Corporation: NV series]

● Connecting the motor and driver

To connect the motor and driver, always use the dedicated connection cable (sold separately). Limit the number of times so that attaching/detaching between the connection cable and the motor or driver will not exceed 100 times.

● Connection cable

Do not apply a strong force on the locking lever of the connector for motor connection. Applying a strong force on the locking lever may cause damage.

● Note on connecting a power supply whose positive terminal is grounded

The driver's USB communication connector is not electrically insulated. When grounding the positive terminal of the power supply, do not connect any equipment (PC, etc.) whose negative terminal is grounded. Doing so may cause the driver and this equipment to short, damaging both.

Installation circumstances

● Grease measures

On rare occasions, grease may ooze out from the gearhead. If there is concern over possible environmental damage resulting from the leakage of grease, check for grease stains during regular inspections. Alternatively, install an oil pan or other device to prevent leakage from causing further damage. Grease leakage may lead to problems in the user's equipment or products.

● Caution when using in low temperature environment

When an ambient temperature is low, since the load torque may increase by the oil seal or viscosity increment of grease used in the gearhead, the output torque may decrease or an overload alarm may generate. However, as time passes, the oil seal or grease is warmed up, and the motor can be driven without generating the overload alarm.

Operations

● Do not use in a vertical application

If the protective function is activated for some reason, the motor may coast to a stop and a load may fall.

● Do not use a solid-state relay (SSR) to turn on/off the power

A circuit that turns on/off the power via a solid-state relay (SSR) may damage the motor and driver.

Insulation resistance measurement and dielectric strength test

Do not conduct the insulation resistance measurement or dielectric strength test with the motor and driver connected

Conducting the insulation resistance measurement or dielectric strength test with the motor and driver connected may result in damage to the product.

Handling of the driver

The driver uses semiconductor elements, so be extremely careful when handling it

Static electricity may cause damage to the driver. Be sure to ground the product so as to prevent electric shock or product damage by static electricity.

Saving the data

Notes about when saving the data to the non-volatile memory

The display blinks while pressing the setting dial to set the data or initializing the data (about 5 seconds).

Do not turn off the power supply while the display on the operation panel is blinking. Doing so may abort writing the data and cause an EEPROM error alarm to generate. The non-volatile memory can be rewritten approximately 100,000 times.

■ Specification change of the driver

Some specifications have been changed in this product. This manual describes contents for the drivers of Ver.2.00 or later, which are after the specification change.

The **MEXE02** of Ver.3.44 or later supports the drivers after the specification change.



Note that some functions described in this manual cannot be used if the version of the driver or **MEXE02** is old. The version of the driver can be checked using the unit information monitor of the **MEXE02**. (⇒ p.61)
The version of the **MEXE02** can be checked from the help menu screen.

● Indication

The ALARM LED blinks in orange when information is generated.

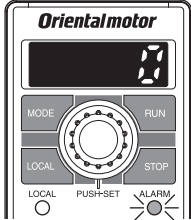

Information is generated in the following cases.

- When a parameter being required configuration was changed
- When "I/O test" or "Teaching, remote operation" was executed
- When any of items fell within the detection range of information

Refer to p.72 for details.

● Function

Parameters	Addition	Driver temperature information, Speed information, Tripmeter information, Odometer information Main power supply time information, Main power supply count information
Informations		Driver temperature, Speed, Tripmeter, Odometer, Main power supply time, Main power supply count
Input signals		TH input, INFO-CLR input

System Configuration

The system configuration of the BLE2 Series is shown below.

Safety precautions

Preparation

How to use

Reference

Appendix

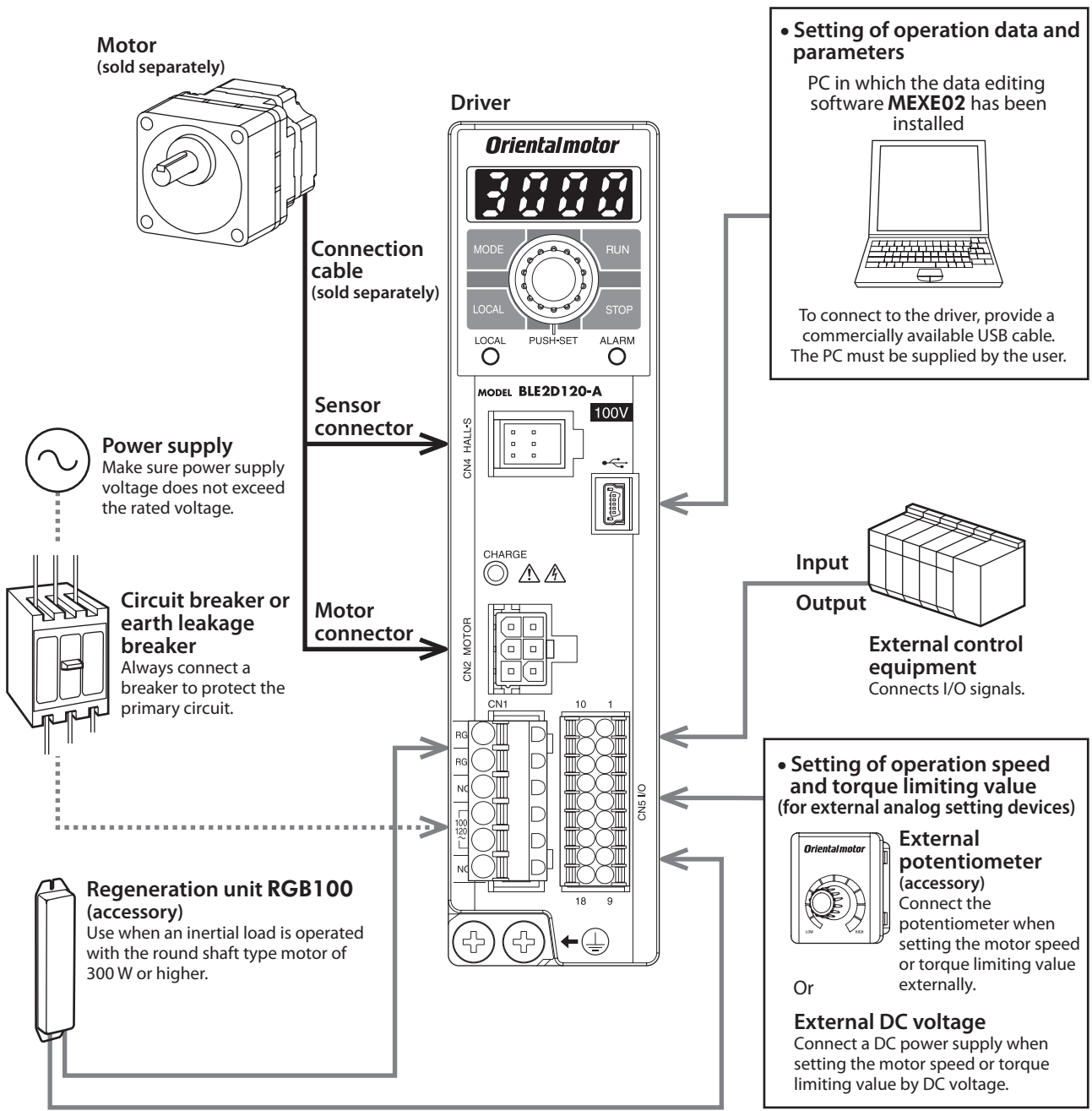

Checking the product

This chapter explains the items you should check, as well as the name and function of each part.

1. Package contents

Verify that the items listed below are included.

Report any missing or damaged items to the branch or sales office from which you purchased the product.

■ Driver

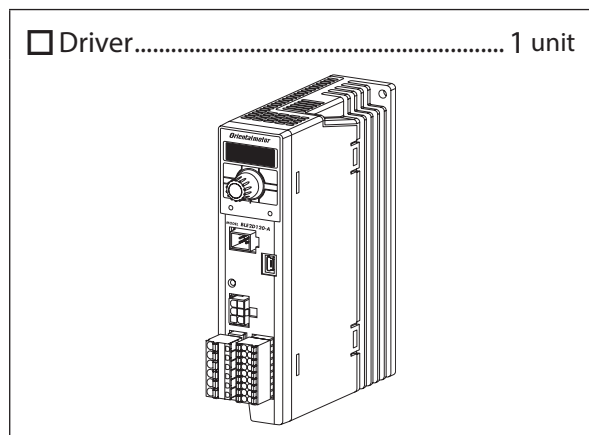

- Operating Manual (this document) 1 copy
 QUICK START GUIDE 1 copy

2. How to identify the product model

● Driver

BLE2D 200 - C

① ② ③

①	Driver type	BLE2D: BLE2 series driver
②	Output power	30: 30 W 60: 60 W 120: 120 W 200: 200 W 300: 300 W 400: 400 W
③	Power supply voltage	A: Single-phase 100-120 VAC C: Single-phase, Three-phase 200-240 VAC S: Three-phase 200-240 VAC

3. Products possible to combine

Products with which drivers can be combined are listed below.

Verify the driver model and the motor model against the model name described on the package label.

□ in the motor model name indicates a code or a number representing the gear ratio, the shaft shape, or the gearhead type. For details about the motor, refer to the operating manual supplied with the motor.

Output power	Power supply voltage	Driver model	Motor model *
30 W	Single-phase 100-120 VAC	BLE2D30-A	BLM230HP-□□
	Single-phase, three-phase 200-240 VAC	BLE2D30-C	
60 W	Single-phase 100-120 VAC	BLE2D60-A	BLM260HP-□□, BLM460SHP-□□ BLM460SHPK-□□□□□□
	Single-phase, three-phase 200-240 VAC	BLE2D60-C	
120 W	Single-phase 100-120 VAC	BLE2D120-A	BLM5120HP-□□, BLM5120HPK-□□□□□□
	Single-phase, three-phase 200-240 VAC	BLE2D120-C	
200 W	Single-phase, three-phase 200-240 VAC	BLE2D200-C	BLM5200HP-□□, BLM5200HPK-□□□□□□ BLM6200SHP-□□□□
300 W	Single-phase, three-phase 200-240 VAC	BLE2D300-C	BLM5300HP-□□, BLM6300SHP-□□□□
400 W	Three-phase 200-240 VAC	BLE2D400-S	BLM5400HP-□□, BLM6400SHP-□□□□

Reference

How to identify the product motor model

- Parallel shaft gearhead **GFV** gearhead
Round shaft

BLM 6 200 S H P - 5 A S
 ① ② ③ ④ ⑤ ⑥ ⑪ ⑫ ⑬

- Right angle hollow shaft hypoidgear **JH** gearhead
Foot mount gearhead **JB** gearhead
Parallel shaft gearhead **JV** gearhead

BLM 5 200 H P K - 5 A B 5 B - L
 ① ② ③ ⑤ ⑥ ⑦ ⑧ ⑨ ⑩ ⑪ ⑬ ⑭

① Motor type	BLM: Brushless Motor
② Frame size	2: 60 mm (2.36 in.) 4: 80 mm (3.15 in.) 5: 90 mm (3.54 in.) 6: 104 mm (4.09 in.)
③ Output power	30: 30 W 60: 60 W 120: 120 W 200: 200 W 300: 300 W 400: 400 W
④ Motor classification	S
⑤ Motor connection method	H: Connector type
⑥ Degree of protection for motor *1	P: IP66
⑦ Combined motor	K: Round shaft type (with key)
⑧ Frame size of combined motor	5: 90 mm (3.54 in.)
⑨ Gearhead size	Code, blank (same width as motor)
⑩ Gearhead type	H: JH gearhead B: JB gearhead V: JV gearhead
⑪ Gear ratio • Motor shaft type	Number: Gear ratio of gearhead A: Round shaft type AC: Round shaft type (Shaft flat)
⑫ Gearhead shaft type	Blank: mm shaft type A: Inch shaft type
⑬ Material of output shaft	C, S: Stainless steel A, B: Carbon steel
⑭ Connector position *2	Blank: Downward -L: Left side

*1 For the degree of protection for when the motor and the gearhead are assembled, refer to the operating manual supplied with the motor.

*2 The code (-L) at the end of the model name is changed for the product that the motor connector position has been changed.

4. Names and functions of parts

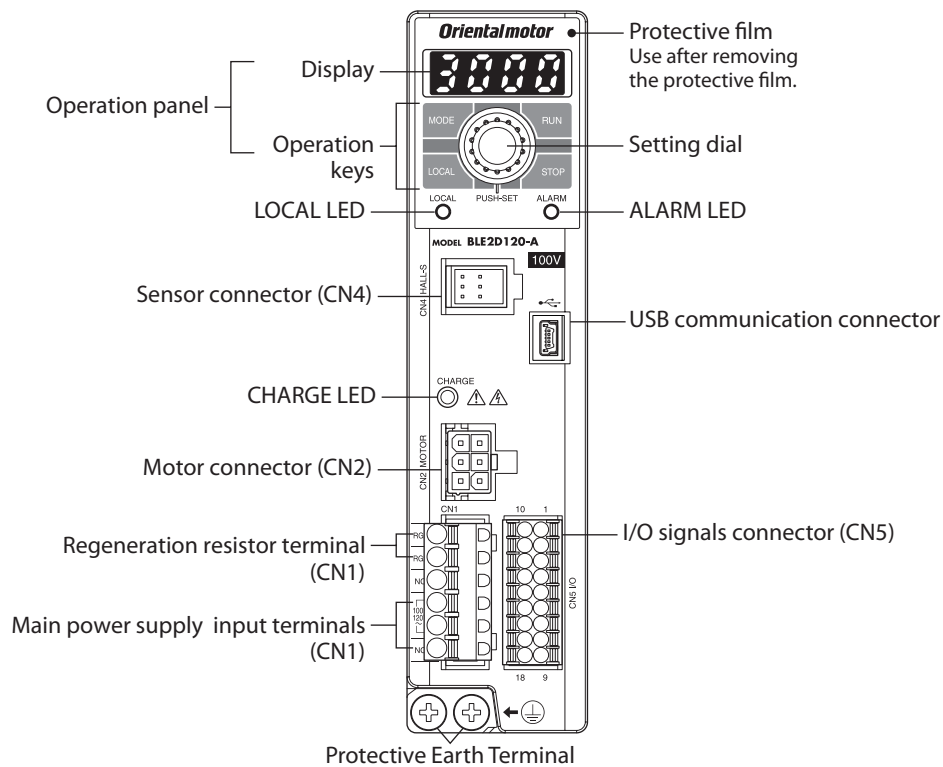

Item	Display	Description	Reference page
Operation panel		Display: This display shows the monitor items, setting screen, alarms, etc.	42
	MODE LOCAL RUN STOP	Operation keys: These keys are used to switch the operation mode or change parameters. When the local control operation is performed, the motor can be operated and stopped using RUN key and STOP key.	
	PUSH-SET	Setting dial: Turn - Setting of parameter value, screen transitions Press - Determine (SET)	
LOCAL LED	LOCAL	This LED is lit in green when the local control operation is performed.	42
ALARM LED	ALARM	This LED blinks in red when an alarm is generated. This LED blinks in orange when information is generated.	70
CHARGE LED	CHARGE	This LED is lit in red while the main power is input. After the main power was turned off, the LED will turn off once the residual voltage in the driver drops to a safe level.	-
Main power supply input terminal (CN1)		Connects the main power supply.	14
	L, N, NC	Single-phase 100-120 VAC: Connects a single-phase 100-120 VAC power supply to L and N. NC is not used.	
	L1, L2, NC L1, L2, L3	Single-phase 200-240 VAC: Connects a single-phase 200-240 VAC power supply to L and N. NC is not used.	
	L1, L2, L3	Three-phase 200-240 VAC: Connects a three-phase 200-240 VAC power supply to L1, L2, L3.	
Regeneration resistor terminal (CN1)	RG1, RG2	Connects the regeneration resistor.	19
Motor connector (CN2)	MOTOR	Connects the power connector (white) of the connection cable.	15
Sensor connector (CN4)	HALL-S	Connects the sensor connector (black) of the connection cable.	
USB Communication connector		Connects a PC in which the MEXE02 has been installed.	18
I/O signals connector (CN5)	I/O	Connects the input signals.	17
		Connects an accessory external potentiometer (sold separately) or external DC power supply.	
		Connects the output signals.	
Protective Earth Terminal		Connects the ground terminal of the connection cable and the grounding wire.	16
Mounting holes (2 locations at the rear)		These mounting holes are used to install the driver with screws (M4 or No.8-32UNC).	12

Installing

This chapter explains the installation locations and installation methods of the driver.

1. Installation location

Install the product in a well-ventilated location that provides easy access for inspection.

- Inside an enclosure installed indoors (provide a ventilation hole)
- Operating ambient temperature: Driver 0 to +50 °C (+32 to +122 °F) (non-freezing)
- Operating ambient humidity: 85% or less (non-condensing)
- Area that is free of explosive atmosphere or toxic gas (such as sulfuric gas) or liquid
- Area not exposed to direct sun
- Area free of excessive amount of dust, iron particles or the like
- Area free of excessive salt
- Area not subject to splashing water (rain, water droplets), oil (oil droplets) or other liquids
- Area not subject to continuous vibration or excessive shocks
- Area free of excessive electromagnetic noise (from welders, power machinery, etc.)
- Area free of radioactive materials, magnetic fields or vacuum
- Altitude Up to 1000 m (3300 ft.) above sea level

2. Installation method

The driver is designed so that heat is dissipated via air convection and conduction through the enclosure.

When installing drivers, provide a clearance of at least 25 mm (0.98 in.) in the horizontal and vertical directions between the driver and enclosure or other equipment within the enclosure.

Installation conditions and operating ambient temperature for the driver vary depending on the installation method.

Note

- Install the driver in an enclosure whose pollution degree is 2 or better environment, or whose degree of protection is IP54 minimum.
- Do not install any equipment that generates a large amount of heat or noise near the driver.
- Do not install the driver underneath the controller or other equipment vulnerable to heat.
- If the ambient temperature of the driver exceeds the upper limit of the operating ambient temperature, revise the ventilation condition or forcibly cool the area around the driver using a fan in order to keep within the operating ambient temperature.
- Be sure to install the driver vertically (in vertical position).

■ When a driver is installed with screws

Install the driver to a flat metal plate offering high heat conductivity [corresponding to an aluminum plate of 200×200×2 mm (7.87×7.87×0.08 in.) or larger].

Install the driver through the mounting holes using two screws (M4 or No.8-32UNC; not supplied).

Operating ambient temperature: 0 to +50 °C (+32 to +122 °F)

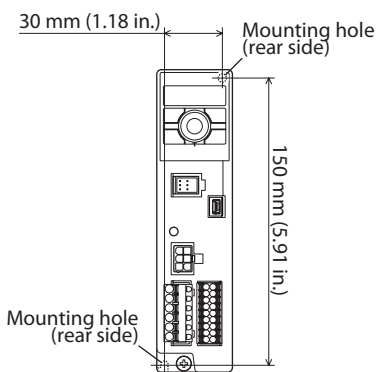

● When installing two or more drivers

When two or more drivers are to be installed side by side, provide 20 mm (0.79 in.) and 25 mm (0.98 in.) clearances in the horizontal and vertical directions, respectively.

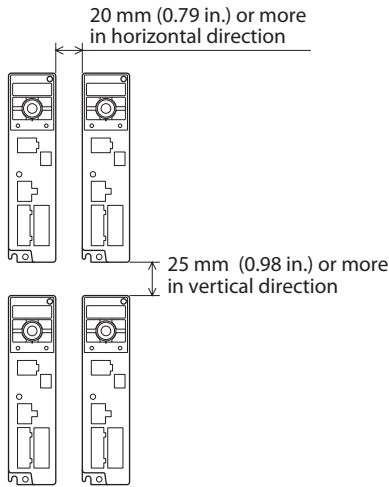

● When drivers are installed in a close contact state

Install drivers to a flat metal plate offering high heat conductivity [corresponding to an aluminum plate of 350×350×2 mm (13.8×13.8×0.08 in.) or larger].

Operating ambient temperature:

30 W, 60 W, 120 W : 0 to +50 °C (+32 to +122 °F)

200 W, 300 W, 400 W : 0 to +40 °C (+32 to +104 °F)

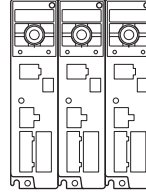

■ Mounting to DIN rail

When installing the driver to a DIN-rail, use an accessory DIN rail mounting plate **MADP02** and mount it to a 35 mm (1.38 in.) wide DIN rail.

After installing to the DIN rail, secure the both sides of the driver with end plates that the customer provides.

Refer to "**MADP02** handling guideline" for the installation method.

Operating ambient temperature: 0 to +40 °C (+32 to +104 °F)

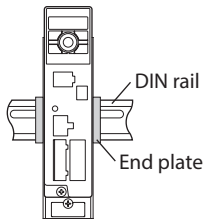

● When drivers are installed in a close contact state*

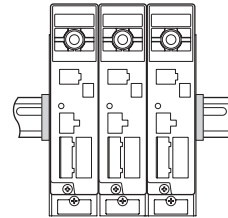

* 300 W type drivers of single-phase 200-240 VAC cannot be installed in a state of being closely contacted. When installing two or more drivers, provide a clearance of 20 mm (0.79 in.) between them in the horizontal direction.

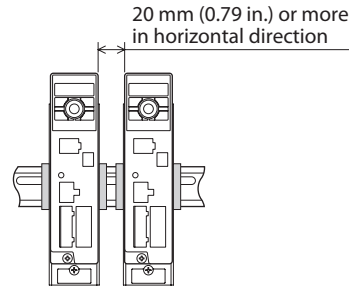

■ Dimension [Unit: mm (in.)]

Mass: 0.8 kg (1.76 lb.)

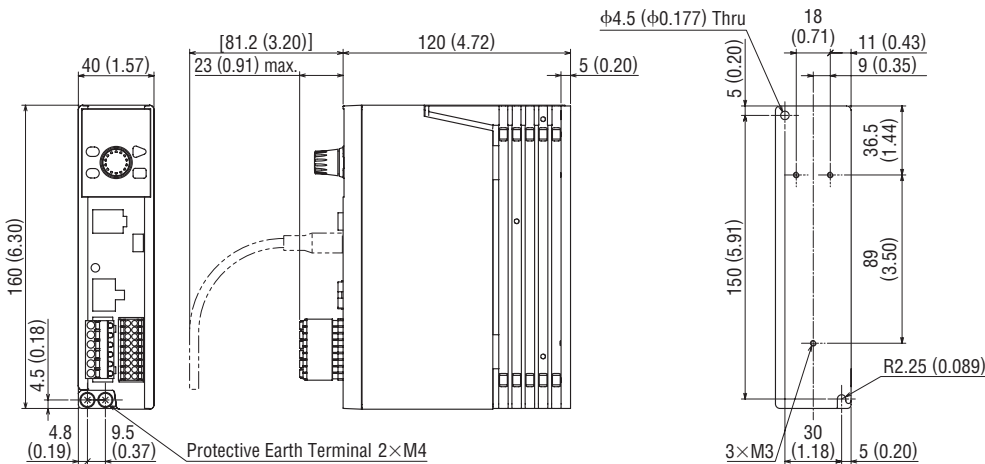

Connecting

This chapter explains how to connect the motor, I/O signals and power supply to the driver, as well as grounding method. For protection against electric shock, do not turn on the power supply until the wiring is completed.

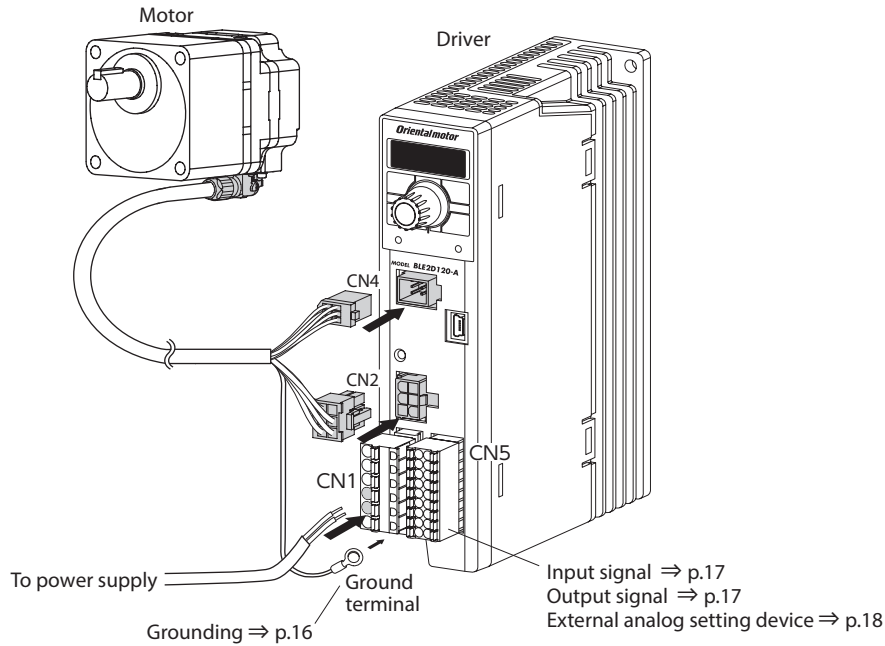

Note

- Have the connector plugged in securely. Insecure connections may cause malfunction or damage to the motor or driver.
- When cycling the power or plugging/unplugging the connector, turn off the power and wait for the CHARGE LED to turn off before doing so. Residual voltage may cause electric shock.

1. Connecting the power supply (CN1)

Note

Check the power-supply voltage specifications of the driver before applying the voltage. If the voltage exceeding the rated range is applied, the driver may be damaged.

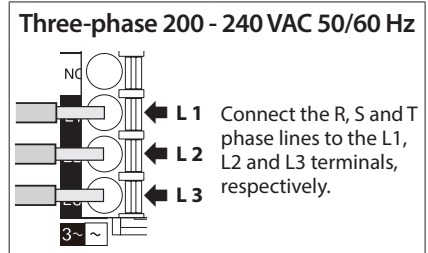
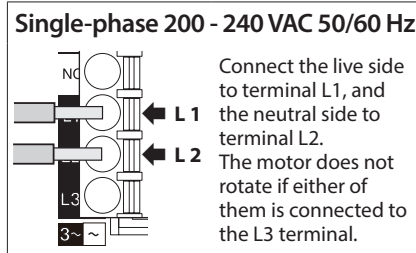
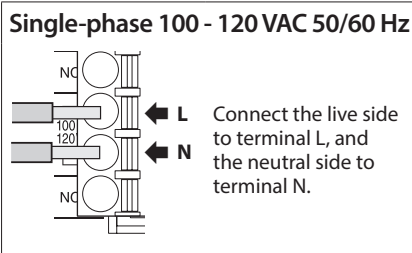

■ Connecting method

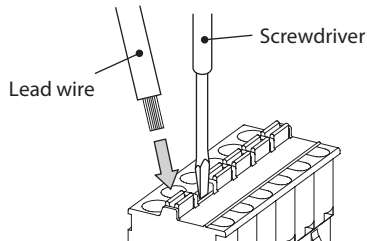

Connector model:
FKCT2,5/6-ST-5,08
(PHOENIX CONTACT GmbH & Co. KG)

Applicable lead wire

- Lead wire size: Stranded wire AWG18 to 14 (0.75 to 2.0 mm²)
- Conductive material: Use only copper wire.

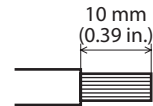

Applicable crimp terminal

Manufacturer: PHOENIX CONTACT GmbH & Co. KG
Model: AI 0,75-10 [Conductor cross-sectional area: 0.65 to 0.82 mm² (AWG18)]
AI 1-10 [Conductor cross-sectional area: 0.82 to 1.2 mm² (AWG18)]
AI 1,5-10 [Conductor cross-sectional area: 1.25 to 1.8 mm² (AWG16)]
AI 2,5-10 [Conductor cross-sectional area: 2.0 to 3.0 mm² (AWG14)]

■ Circuit breaker

Be sure to connect a circuit breaker to the power line of the driver to protect the primary circuit.

- Rated current of protective device: 10 A
- Circuit breaker: Mitsubishi Electric Corporation NF30

2. Connecting the motor and driver

Connect the connection cable (sold separately) to the motor and driver.
The connection cables are provided up to 20 m (65.6 ft.).

There are two types of connection cables which cable leading directions are different.
The following explains as an example of "leading in direction of output shaft"

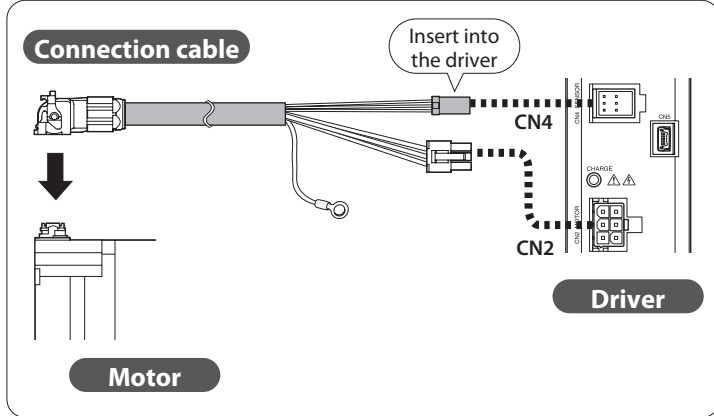

[Cable leading direction]

Leading in direction of output shaft

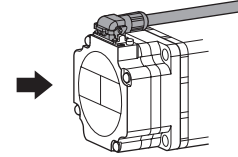

Leading in opposite direction of output shaft

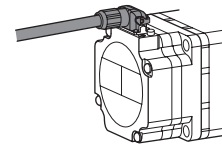

■ Connection procedures of the motor and connection cable

1 Remove

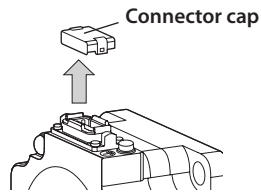

2 Attach

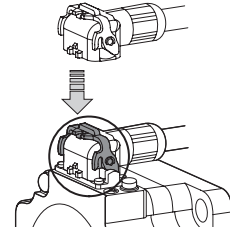

Position of lever

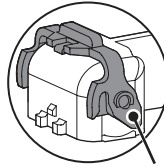

Locking lever

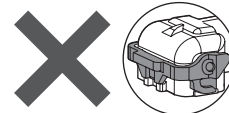

The connector cannot be inserted if the locking lever is turned down.

3 Secure

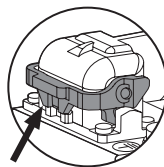
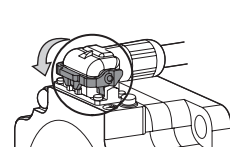

Be sure to turn down the locking lever till the position shown in the figure.

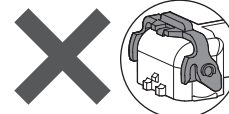

The connector cannot be secured unless the locking lever is turned down.

Note Do not carry the motor by holding the cable. Doing so may cause damage to the product.

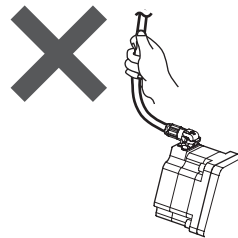

■ Detaching the connection cable

If the locking lever is turned up, the cable can be detached.

■ Extension between motor and driver

Use a connection cable (accessory) for relay when extending the wiring distance between the motor and driver. The connection cable for relay can be used by connecting up to 2 pieces. The wiring distance between the motor and driver can be extended to a maximum of 20.5 m (67.2 ft.).

Example of use: Example of extension by adding two connection cables

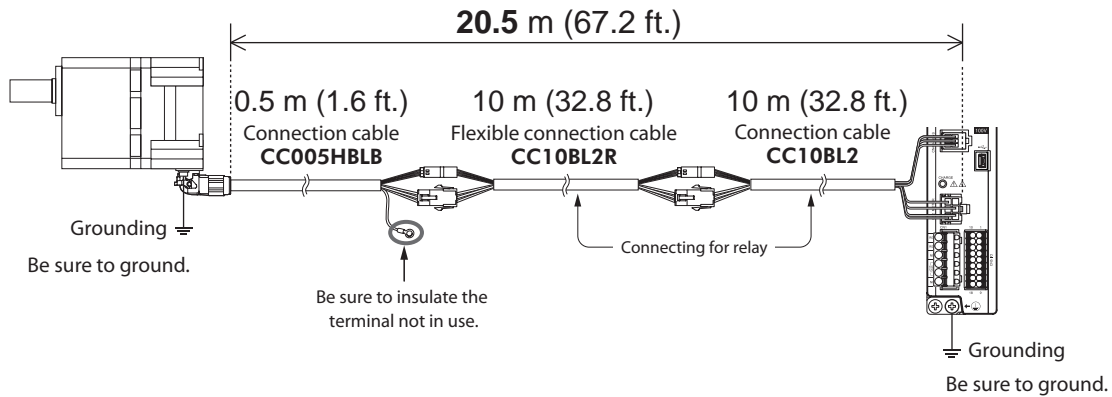

- Note**
- Secure each connectors part not to apply stress on the connectors part. If not secured, the cables may damage by the stress.
 - Securely insert the connector straight. Insecure connections may cause malfunction or damage to the motor or driver.
-

3. Grounding

Ground using the Protective Earth Terminals (⊕) of the motor and driver, as well as the ground terminal of the connection cable.

- Note**
- Be sure to ground the product. Failure to do so may result in electric shock or damage to the product. Static electricity may cause damage to the product if the Protective Earth Terminals are not grounded.

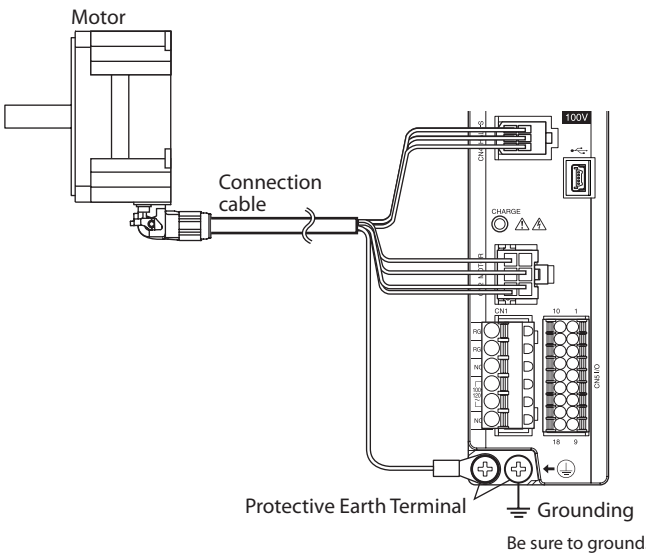

Two Protective Earth Terminals (⊕) are provided on the driver. Be sure to ground one of the Protective Earth Terminals. Do not share the Protective Earth Terminal with a welder or any other power equipment. Connect the ground terminal of the connection cable to the other terminal. However, the grounding resistance value provided in the standards that is applied to the equipment may not be satisfied depending on the type or length of the connection cable. In this case, ground near the motor using the Protective Earth Terminal (⊕) on the motor. If the ground terminal of the connection cable is not used, be sure to insulate.

Reference
 Protective Earth wire of the connection cable
 Conductor size: AWG18 (0.75 mm²)
 Maximum conductor resistance: 25.0 Ω/km

Ground terminal

- Applicable crimp terminal: Round crimp terminal with insulation cover
- Terminal screw size: M4
- Tightening torque: 1.2 N·m (10.6 lb-in)
- Applicable lead wire: AWG18 to 14 (0.75 to 2.0 mm²)

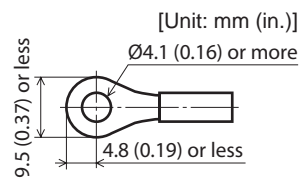

■ Precautions about static electricity

Static electricity may cause the driver to malfunction or suffer damaged. Be sure to ground the motor and driver to prevent them from being damaged by static electricity.

4. Connecting the I/O signals (CN5)

Connect the input signals and output signals to the CN5.

■ Connecting method

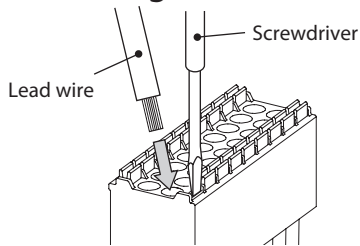

Connector model: DFMC1,5/9-ST-3,5
(PHOENIX CONTACT GmbH & Co. KG)

Applicable lead wire

- Lead wire size: Stranded wire AWG24 to 18 (0.2 to 0.75 mm²)
- Conductive material: Use only copper wire.

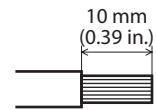

Applicable crimp terminal

Manufacturer: PHOENIX CONTACT GmbH & Co. KG

- Model: AI 0,25-10 [Conductor cross-sectional area: 0.14 to 0.34 mm² (AWG24)]
- AI 0,34-10 [Conductor cross-sectional area: 0.14 to 0.34 mm² (AWG22)]
- AI 0,5-10 [Conductor cross-sectional area: 0.40 to 0.65 mm² (AWG20)]
- AI 0,75-10 [Conductor cross-sectional area: 0.65 to 0.82 mm² (AWG18)]

Pin assignment	Pin No.	Signal name	Function*	Description	
	1	IN-COM0	Input signals common (for external power supply)	Connect when using an external power supply.	
	2	IN0	[FWD]	The motor rotates in the CW direction while this signal is being ON.	
	3	IN1	[REV]	The motor rotates in the CCW direction while this signal is being ON.	
	4	IN2	[STOP-MODE]	This signal is used to select how to stop the motor. When it is OFF, the motor decelerates to a stop.	
	5	IN3	[M0]	The operation data number can be selected based on the combination of ON-OFF states of the M0 and M1 inputs.	
	6	IN4	[M1]		
	7	IN5	[ALARM-RESET]	This signal is used to reset the alarm.	
	8	IN6	[Not used]	Various functions can be assigned.	
	9	IN-COM1	0 V (for internal power supply)	Connect when using an internal power supply.	
	10	TH	TH	When a regeneration resistor is used, connect the thermostat output of the regeneration resistor (normally closed). If the regeneration resistor overheats to turn the thermostat output OFF, the "regeneration resistor overheat" alarm is generated.	
	11				
	12	VH	External analog setting input	These signals are connected when the rotation speed or torque limiting value is set externally using an external potentiometer or external DC voltage. (Refer to p.18)	
	13				VM
	14				VL
	15	OUT0+	[SPEED-OUT]	30 pulses are output while the motor output shaft makes one revolution.	
	16	OUT0-			
	17	OUT1+	[ALARM-OUT]	This signal will be output when an alarm generates. (Normally closed)	
	18	OUT1-			

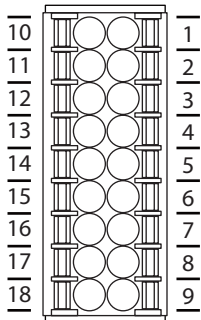

* The signal in brackets [] is a function that is assigned at the time of shipment.
For the pin No.2 to 8 and No.15 to 18, the assigned function can be changed. Refer to p.24 for details.

■ Input signals circuit

All input signals of the driver are photocoupler inputs.
When an external power supply is used: 20.4 to 28.8 VDC, 100 mA or more

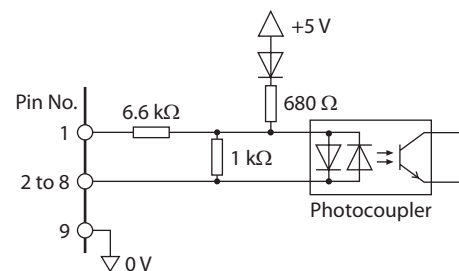

■ Output signals circuit

All output signals of the driver are photocoupler/open-collector outputs.
ON voltage: 1.6 VDC maximum
External power supply: 4.5 to 30 VDC, 100 mA or less
(5 mA or more for the SPEED-OUT output)

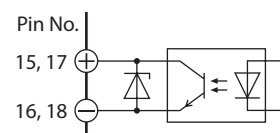

- Note**
- Always connect a current-limiting resistor. If the power supply voltage is connected to the output circuit directly without connecting a current-limiting resistor in between, the driver will be damaged.
 - When connecting a relay (inductive load), etc., to detect alarm outputs, provide a fly-back voltage control measure based on diode, etc., for the inductive load. Or use a relay with built-in flywheel diode.

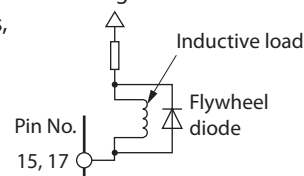

■ When using a controller with a built-in clamp diode

If a controller with a built-in clamp diode is used, a leakage path may form and cause the motor to operate even when the controller power is off, as long as the driver power is on.

Since the power capacity of the controller is different from that of the driver, the motor may operate when the controller and driver powers are turned on or off simultaneously.

When powering down, turn off the driver power first, followed by the controller power, and when powering up, turn on the controller power first, followed by the driver power.

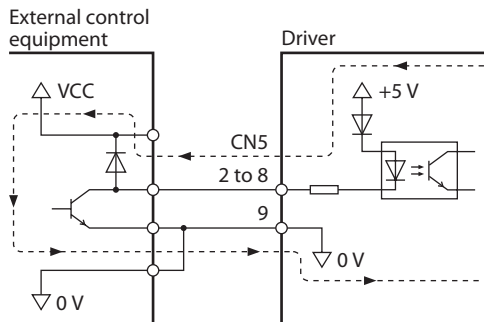

5. Connecting external analog setting devices

Using an accessory external potentiometer or external DC voltage, the analog setting for the rotation speed or torque limiting value can be performed. Refer to p.32, p.35, and p.53 for the setting method.

■ Using an external potentiometer

Connect to the pin No.12 to 14 of the CN5.

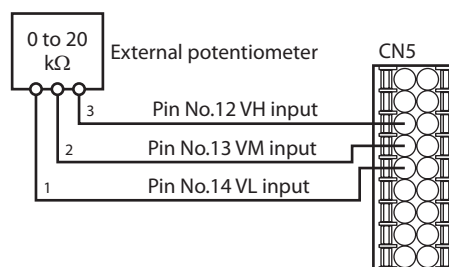

■ Using external DC voltage

For the external voltage, use a DC power supply with reinforced insulation on its primary and secondary sides, and connect the pin No.13 and 14 of the CN5. The input impedance between the VM input and VL input is approximately 41.8 kΩ.

The VL input is connected to the IN-COM1 inside the driver.

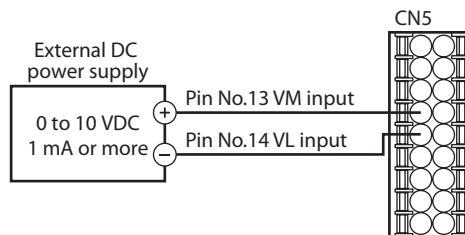

Note Be sure to set the external DC voltage to 10 VDC or lower. When connecting the external DC power supply, make sure the polarities are correct. Reversing the polarities may cause damage to the driver.

6. Connecting the USB cable

When the **MEXE02** is used, connect a USB cable to the USB communication connector.

Specifications of USB cable

Specifications	USB2.0 (full speed)
Cable	Length: 3 m (9.8 ft.) or less Shape: A-mini-B

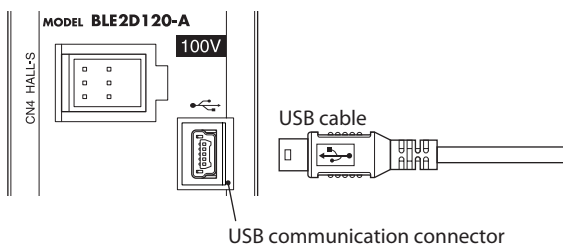

Note

- Connect the driver and PC directly using the USB cable without using a hub or extension cable.
- In large electrically noisy environments, use the USB cable with a ferrite core or install a ferrite core to the USB cable.

■ Setting of ID

If the specific USB-ID (serial number) is assigned to the driver, the individual COM port number can be set in each axis. When two or more drivers are connected to a PC at the same time, the individual COM port number can be set in each USB-ID. When multiple axes are connected with the USB cable at the same time, set the "USB-ID enable" parameter to "Enable," and set the individual ID to each axis. To change the USB-ID, Windows automatically assign the specific COM port number in each ID.

Related parameters

ID	Parameter name	Description	Setting range	Factory setting
498	USB-ID enable	Sets whether to enable or disable the USB-ID. When it is set to "Disable," the USB-ID is automatically set to a random number.	0: Disable 1: Enable	1
499	USB-ID	Sets the USB-ID (serial number). The COM port at power-on can be fixed.	0 to 999,999,999	0
2555	USB-PID	Sets the ID to be displayed in the COM port.	0 to 31	0

Note If the COM port number is changed, set the "Communication port setting" of the **MEXE02** again according to the COM port number after being changed.

7. Connecting the regeneration resistor

When an inertial load is operated with the round shaft type motor of 300 W or higher, use an accessory regeneration resistor **RGB100** (sold separately).

If the stopping time gets longer when starting and stopping operations of a large inertia load are repeated frequently, use the regeneration resistor.

Install the regeneration resistor in a location where heat dissipation capacity equivalent to a level achieved with a heat sink [made of aluminum, 350×350×3 mm (13.78×13.78×0.12 in.)] is ensured.

7-1 Connection method

Connect the regeneration resistor before turning on the main power.

- Regenerative current flows through the two thick lead wires (AWG18: 0.75 mm²) of the regeneration resistor. Connect them to the RG1 and RG2 terminals of the CN1.
- The two thin lead wires (AWG22: 0.3 mm²) of the regeneration resistor are thermostat outputs. Connect them to the TH input of the CN5.

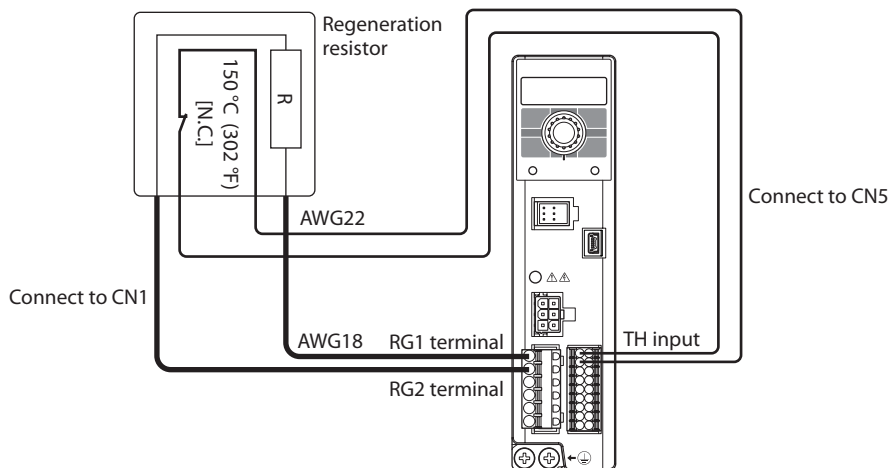

- Note**
- Be sure to connect the thermostat output to the TH input when using the regeneration resistor.
 - If the regeneration resistor overheats to exceed the permissible temperature, the thermostat output is turned OFF to generate the "regeneration resistor overheat" alarm. If the "regeneration resistor overheat" alarm was generated, reconsider the driving condition, ambient temperature and others.

7-2 Regeneration resistor specifications

Model	Continuous regenerative power	Instantaneous regenerative power	Resistance value	Thermostat operating temperature
RGB100	70 W	720 W	150 Ω	Operation: Open at 150±7 °C (302±13 °F) Reset: Close at 145±12 °C (293±22 °F) [Normally closed]

8. Connection diagram

■ Sink logic

● When using the built-in power supply

This is a connection example for when the power supply is single-phase 100-120 VAC, the rotation speed is set externally, and the internal power supply is used for input signals. The I/O signal in the brackets [] is the factory setting. Refer to p.59 for the assignment of I/O signals.

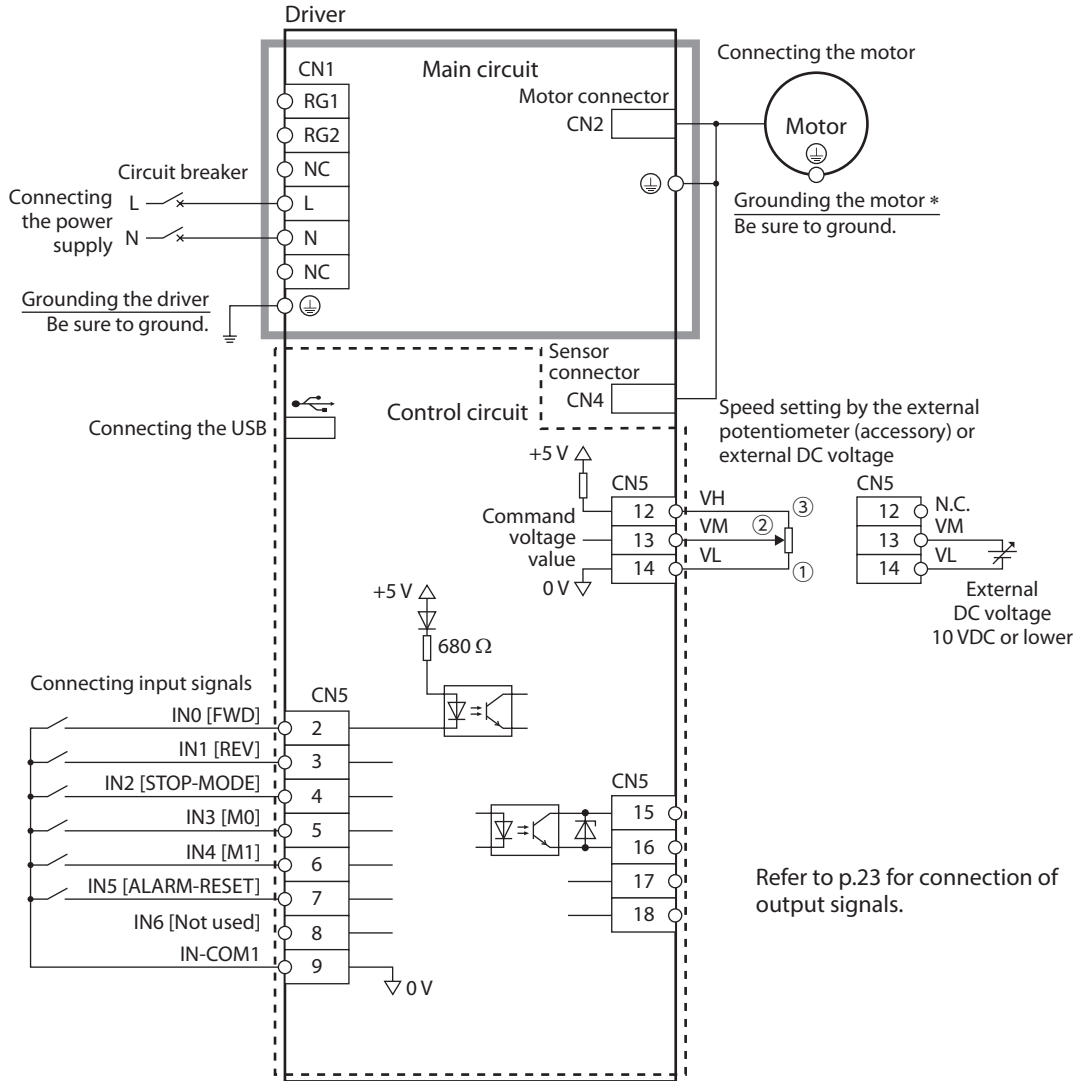

* Be sure to ground. Refer to "3. Grounding" on p.16 for grounding.

● When using the external power supply

This is a connection example for when the power supply is single-phase 100-120 VAC and the motor is operated by setting the rotation speed externally.
 The I/O signal in the brackets [] is the factory setting.
 Refer to p.59 for the assignment of I/O signals.

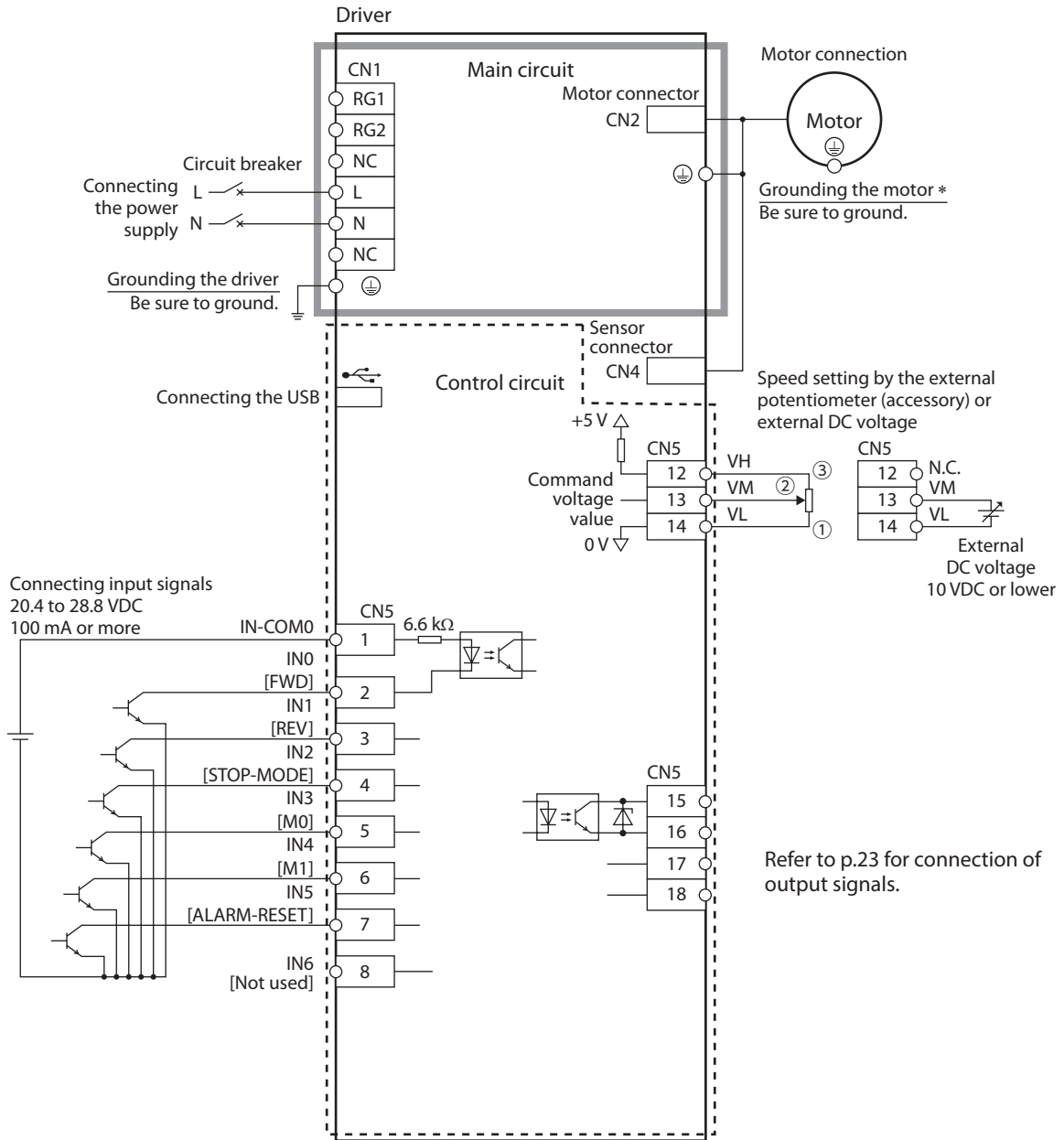

* Be sure to ground. Refer to "3. Grounding" on p.16 for grounding.

Note Use a power supply of 20.4 VDC to 28.8 VDC, 100 mA or more, for connecting input signals.

■ Source logic

When using the external power supply

This is a connection example for when the power supply is single-phase 100-120 VAC and the motor is operated by setting the rotation speed externally.

The I/O signal in the brackets [] is the factory setting.

Refer to p.59 for the assignment of I/O signals.

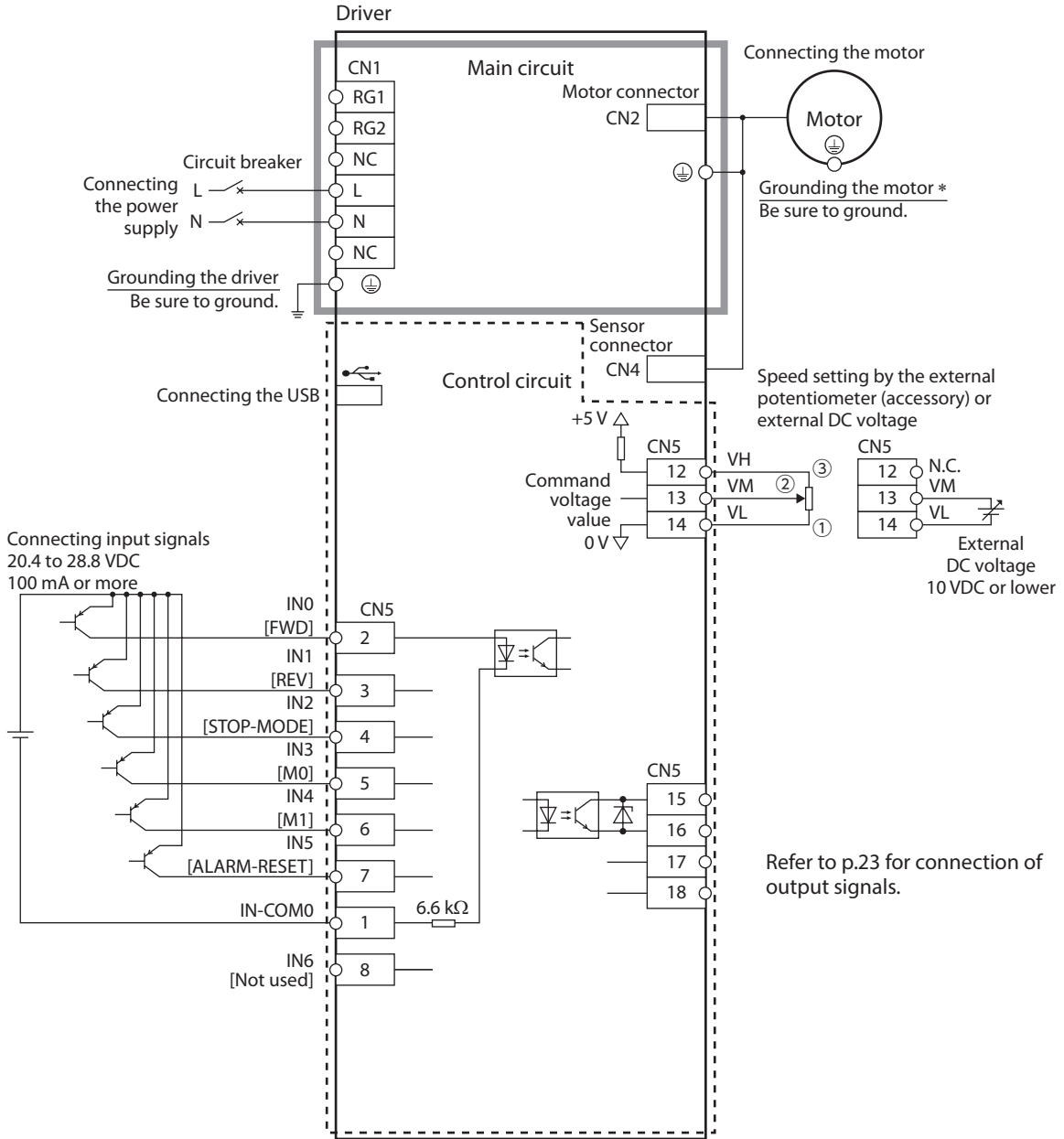

* Be sure to ground. Refer to "3. Grounding" on p.16 for grounding.

Note

Use a power supply of 20.4 VDC to 28.8 VDC, 100 mA or more, for connecting input signals.

■ Connection example for I/O signals and programmable controller

● Sink logic

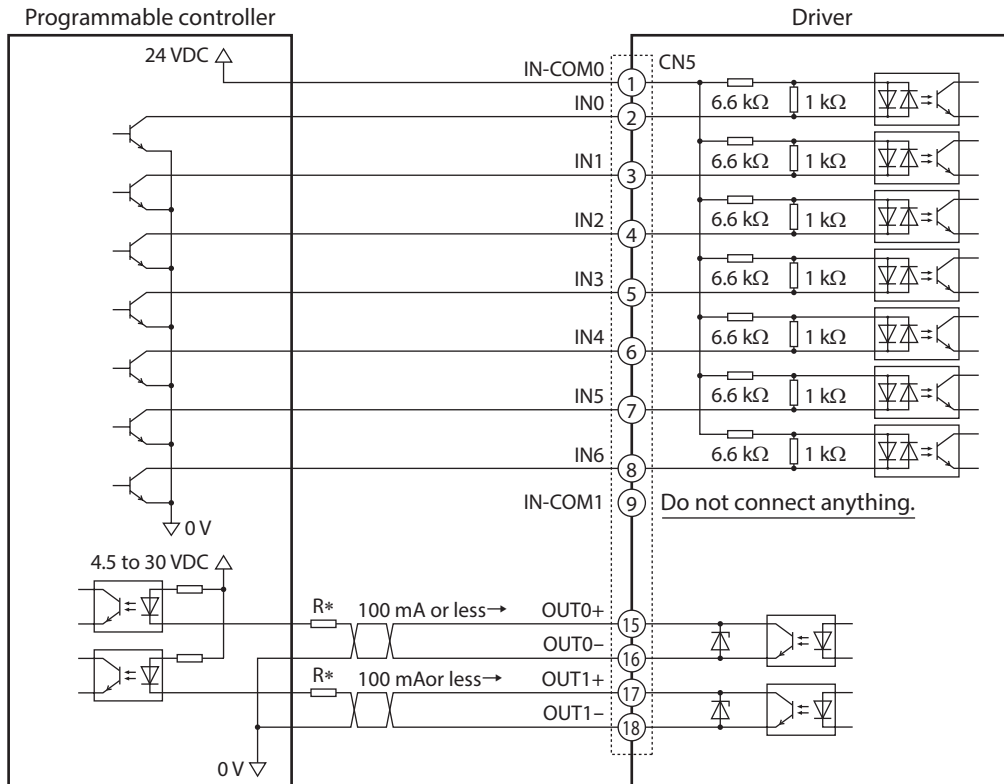

* Recommended resistance value when the current limiting resistor R is connected
 In the case of 24 VDC: 680 Ω to 2.7 kΩ (2 W) In the case of 5 VDC: 150 Ω to 560 Ω (0.5 W)

● Source logic

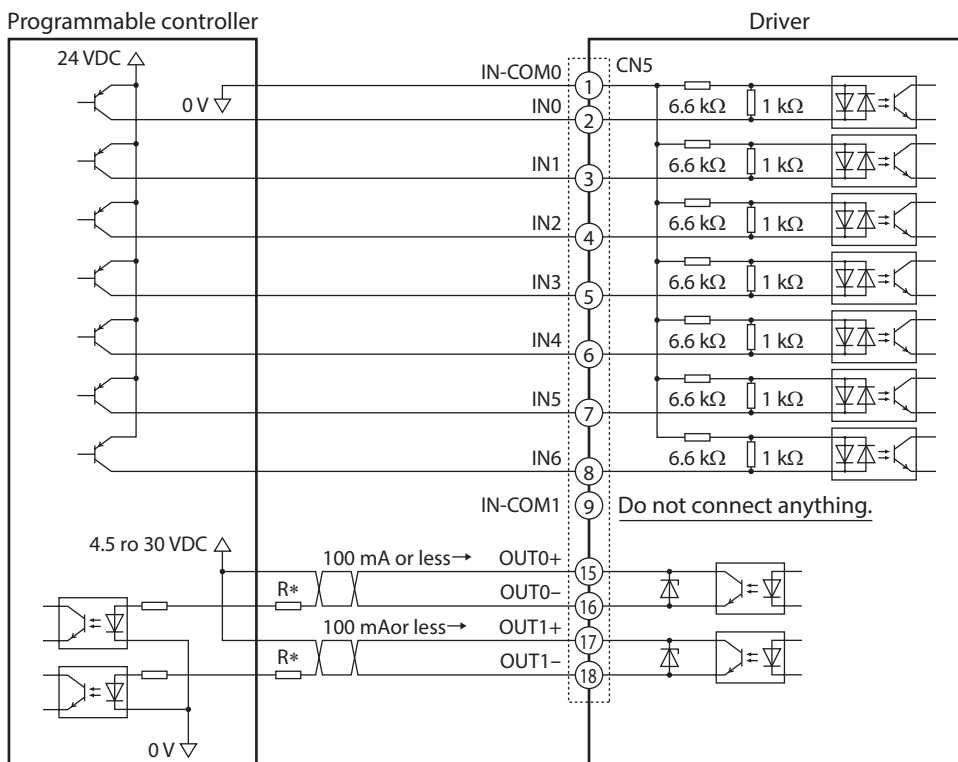

* Recommended resistance value when the current limiting resistor R is connected
 In the case of 24 VDC: 680 Ω to 2.7 kΩ (2 W) In the case of 5 VDC: 150 Ω to 560 Ω (0.5 W)



- Use output signals at 4.5 VDC to 30 VDC.
- Be sure to use the current of the OUT0 and OUT1 at 100 mA or less. If the current exceeds this value, connect the current limiting resistor R.
- Pass the current of 5 mA or more for the SPEED-OUT output.
- Do not connect anything to the pin No.9 when using an external power supply.

9. I/O signals

This section explains about input signals and output signals.

9-1 I/O signals list

■ Input signals

Signal name	Function	Connection	Reference page
IN0	FWD	This is a signal to operate the motor. When either the FWD input or REV input is turned ON, the motor rotates. The motor stops when the signal is turned OFF. The motor rotates in the direction set in the "Rotation direction" parameter.	2-wire input mode p.26
IN1	REV		
IN2	STOP-MODE		
IN3	M0	This is a signal to select the operation data number. The operation data can be switched when multi-speed operation is performed. Up to 4 data can be switched using the M0 and M1 inputs.	p.27
IN4	M1		
IN5	ALARM-RESET	This is a signal to reset the present alarm when a driver protective function was activated.	p.27
IN6	Not used	Various functions can be assigned.	-
Signals being possible to change the assignment	START/STOP	This is a signal to operate the motor. The motor rotates when the START/STOP input and RUN/BRAKE input are turned ON. If the START/STOP input is turned OFF, the motor decelerates to a stop. If the RUN/BRAKE input is turned OFF, the motor stops instantaneously.	3-wire input mode p.26
	RUN/BRAKE		
	CW/CCW		
	M2	This is a signal to select the operation data number. Up to 16 data can be switched using the M0, M1, M2, and M3 inputs.	p.27
	M3		
	H-FREE	This is a signal to select whether to enable or disable the slight position-keeping function. Holding of the motor shaft by the slight position-keeping function can externally be switched at motor standstill.	p.28
	TL		
	INFO-CLR		
	HMI		
	EXT-ERROR		

■ Output signal

Signal name	Function	Connection	Reference page
OUT0	SPEED-OUT	This is a signal to be output in synchronization with the motor rotation. 30 pulses are output while the motor output shaft makes one revolution.	p.28
OUT1	ALARM-OUT	This is a signal to be output when a driver protective function was activated. (Normally closed)	
Signals being possible to change the assignment	MOVE	This is a signal to be output when the motor is rotating by turning the operation input signal ON.	p.29
	INFO	This is a signal to be output when information is generated.	
	TLC	This is a signal to be output when the motor output torque reached the torque limiting value.	
	VA	This is a signal to be output when the motor detection speed reached the plus or minus range of "VA detection width" against the setting speed.	
	DIR	This is a signal to be output the motor rotation direction.	

: These are functions to be assigned at the time of shipment.

Refer to "I/O function selection parameters" (p.59) when changing the signal assigned in the I/O signal terminals.

9-2 Overview of I/O signals

Input signal

Internal input circuit

All input signals of the driver are photocoupler inputs. They are turned "ON" when the current flows to the photocoupler, and they are turned "OFF" when the current does not flow.

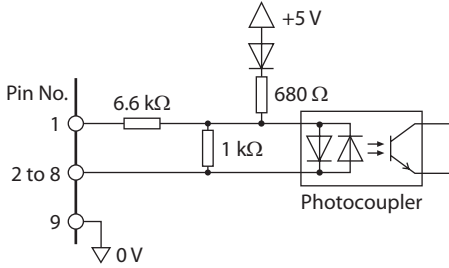

Changing the logic level setting of input signals

The logic level setting for input terminals IN0 to IN6 can be changed using the parameter.

Related parameters

ID	Parameter name	Description	Setting range	Factory setting
2128	IN0 input logic level setting	Changes the logic level setting for the input terminals IN0 to IN6.	0: Non invert 1: Invert	0
2129	IN1 input logic level setting			
2130	IN2 input logic level setting			
2131	IN3 input logic level setting			
2132	IN4 input logic level setting			
2133	IN5 input logic level setting			
2134	IN6 input logic level setting			

Output signal

Internal input circuit

All output signals of the driver are photocoupler/open-collector outputs.

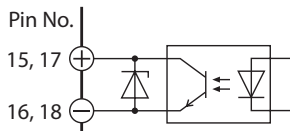

Changing the logic level setting of output signals

The logic level setting for output terminals OUT0 and OUT1 can be changed using the parameter.

However, if the SPEED-OUT output is assigned, it cannot be changed.

Related parameters

ID	Parameter name	Description	Setting range	Factory setting
2160	OUT0 output logic level setting	Changes the logic level setting for the output terminal.	0: Non invert 1: Invert	0
2161	OUT1 output logic level setting			

9-3 Descriptions of input signals

Operation input signals vary depending on the input mode. The input mode can be changed by the setting of the "Operation input mode selection" parameter (ID: 1819). Refer to p.58 for details.

■ 2-wire input mode

● FWD input, REV input

When the FWD input is turned ON, the motor rotates in the CW direction. The motor decelerates to a stop when the signal is turned OFF.

When the REV input is turned ON, the motor rotates in the CCW direction. The motor decelerates to a stop when the signal is turned OFF.

The motor rotation direction can be changed by the setting of the "Motor rotation direction" parameter (ID: 450). Refer to p.38 for the rotation direction.

If both the FWD and REV inputs are turned ON, the motor decelerates to a stop.

● STOP-MODE input

This is a signal to select how the motor should stop when the FWD input or REV input is turned OFF.

When the STOP-MODE input is OFF, the motor decelerates to a stop according to the deceleration time of the operation data number.

When the STOP-MODE input is ON, the motor stops at the shortest time (instantaneous stop).

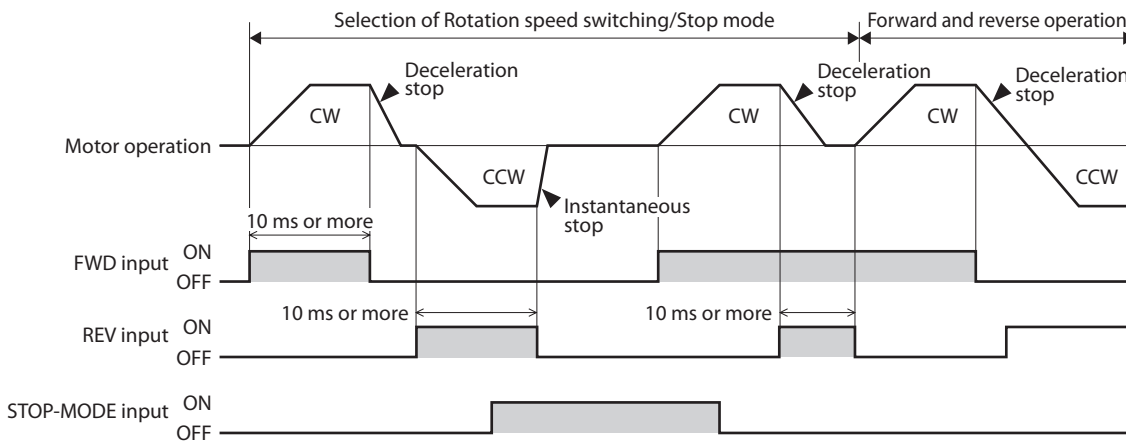

■ 3-wire input mode

● START/STOP input, RUN/BRAKE input

The motor rotates when the START/STOP input and RUN/BRAKE input are turned ON.

When the START/STOP input is turned OFF while the motor is rotating, the motor decelerates to a stop according to the deceleration time of the operation data number.

If the RUN/BRAKE input is turned OFF while the motor is rotating, the motor stops at the shortest time (instantaneous stop).

● CW/CCW input

This is a signal to change the motor rotation direction. The motor rotates in the CCW direction when this signal is turned ON, and in the CW direction when it is turned OFF.

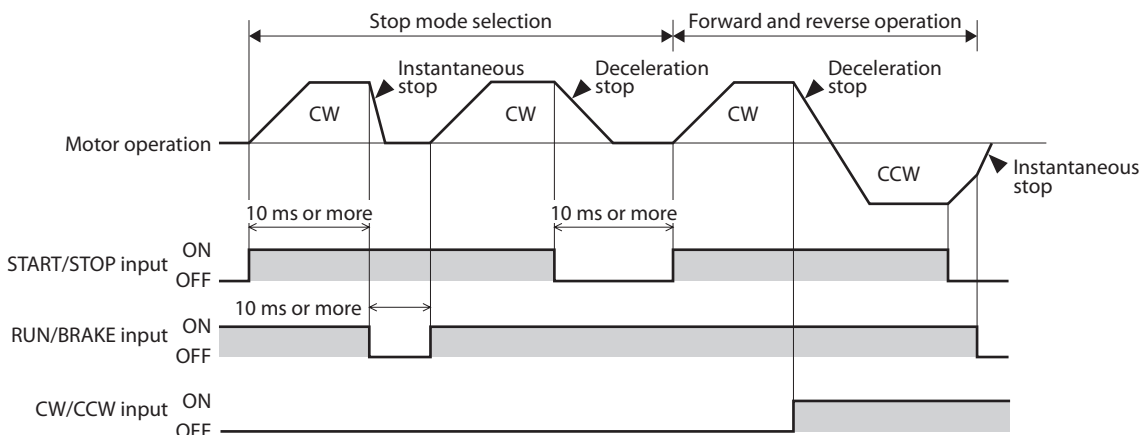

■ M0 to M3 inputs

A desired operation data number can be selected by a combination of ON-OFF status of the M0 to M3 inputs. The M0 and M1 inputs are assigned at the time of shipment. If the M2 and M3 inputs are assigned, the operation of 16 speeds can be performed.

Operation data No.	M3	M2	M1	M0
0	OFF	OFF	OFF	OFF
1	OFF	OFF	OFF	ON
2	OFF	OFF	ON	OFF
3	OFF	OFF	ON	ON
4	OFF	ON	OFF	OFF
5	OFF	ON	OFF	ON
6	OFF	ON	ON	OFF
7	OFF	ON	ON	ON
8	ON	OFF	OFF	OFF
9	ON	OFF	OFF	ON
10	ON	OFF	ON	OFF
11	ON	OFF	ON	ON
12	ON	ON	OFF	OFF
13	ON	ON	OFF	ON
14	ON	ON	ON	OFF
15	ON	ON	ON	ON

Refer to p.38 for how to set to operate two or more speeds.

■ ALARM-RESET input

To reset an alarm, turn the FWD input and REV input OFF, and remove the cause of the alarm before turning the ALARM-RESET input ON. If either the FWD input or REV input is being ON, the ALARM-RESET input is disabled. (In the case of 3-wire input mode, when both the START/STOP input and RUN/BRAKE input are being ON, the ALARM-RESET input is disabled.)

If the alarm cannot be reset with the ALARM-RESET input, once turn off the power, and turn on the power again after the CHARGE LED is turned off.

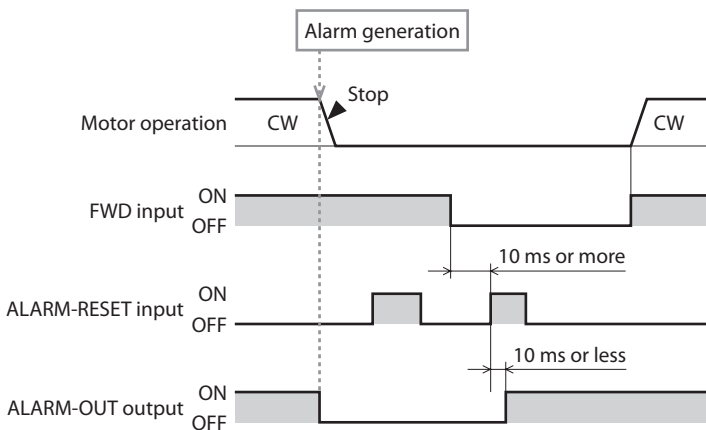

Note

- Continuing the operation without removing the cause of the alarm may cause damage to equipment.
- The overcurrent and EEPROM errors cannot be reset using the ALARM-RESET input.

■ Other inputs

● H-FREE input

This input signal can be used when the slight position-keeping function is enabled.

If the H-FREE input is turned ON when the motor shaft is electrically held by the slight-position keeping function, the motor shaft can be rotated externally.

● TL input

The TL input is normally closed.

When the TL input is turned ON, the torque limiting function is enabled.

The motor output torque is limited based on the set torque.

When the TL input is turned OFF, the torque limiting function is disabled, and the maximum value of the motor output torque will be the maximum instantaneous torque.

● INFO-CLR input

The INFO-CLR input is used to clear a state of generating information when you use with setting the "INFO auto clear" parameter to disable.

● HMI input

The HMI input is normally closed.

When the HMI input is turned ON, the function limitation of the operation panel and **MEXE02** are released. When the HMI input is turned OFF, the function limitation will be imposed.

[Functions to be limited]

- I/O test
- Local control operation
- Teaching, remote operation
- Editing parameters and data, downloading, initializing
- Configuration

● EXT-ERROR input

The EXT-ERROR input is normally closed.

When this signal is turned OFF, an alarm generates, and the motor stops instantaneously.

Then "AL.E" is shown on the display.



Note

When the HMI input, TL input, and EXT-ERROR input are not assigned to input terminals, they are always set to ON. And if a single input is assigned to multiple input terminals, the function will be performed when all of the terminals are turned ON.

9-4 Descriptions of output signals

■ SPEED-OUT output

30 pulses are output while the motor output shaft makes one revolution in synchronization with the motor operation.

The pulse width of output pulse signals is 0.2 ms. The motor rotation speed can be calculated using the SPEED-OUT output.

$$\text{Frequency of the SPEED-OUT (Hz)} = \frac{1}{T}$$

$$\text{Rotation speed (r/min)} = \frac{\text{Frequency of the SPEED-OUT}}{30} \times 60$$

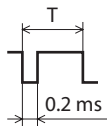

■ ALARM-OUT output

When the protective function of the driver is activated, the ALARM-OUT output is turned OFF and the ALARM LED blinks (normally closed).

At the same time, the alarm code is shown on the display of the operation panel, and the motor coasts to a stop. (Instantaneous stop at the time of external stop)

■ MOVE output

The MOVE output is turned ON when the motor is rotating by turning the operation input signal ON.

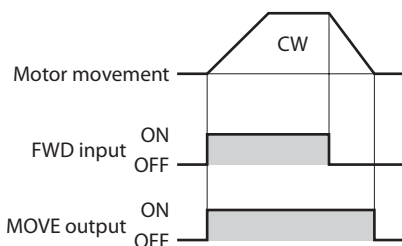

■ INFO output

If information is generated, the INFO output is turned ON.
You can set whether to turn the INFO output ON or OFF in each INFO action parameter.
Refer to p.55 for details.

■ TLC output

When the motor torque reaches the torque limiting value, the TLC output is turned ON.

Note If the torque limiting value is set to less than 20%, the TLC output may not be stable.

■ VA output

This signal is turned ON when the detection speed reaches "plus or minus range of VA detection width against the setting speed."
The width to turn the VA output ON can be set using the "VA detection width" parameter (ID: 1817).

Related parameters

ID	Parameter name	Description	Setting range	Factory setting
1817	VA detection width	Sets the detection width for the VA output.	1 to 400 r/min	200

Example: When the motor speed changes from the setting speed 1 to the setting speed 2

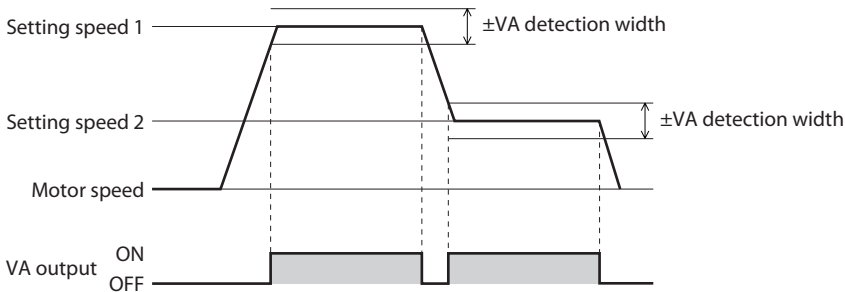

■ DIR output

This is a signal to output the motor rotation direction.
It is turned ON when the motor rotates in the direction to which the positive side was set in the "Motor rotation direction" parameter.

Related parameters

ID	Parameter name	Description	Setting range	Factory setting
450	Motor rotation direction	Sets the rotation direction of the motor output shaft when inputting the FWD input.	0: Positive direction=CCW 1: Positive direction=CW	1

Example: When the "Motor rotation direction" parameter (ID: 450) is set to 1

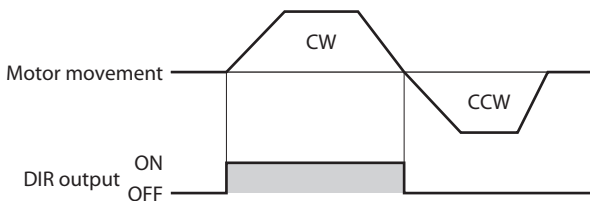

Operating

There are two methods to operate the motor.

Operation using the operation panel

The motor can be operated using the operation panel of the driver.

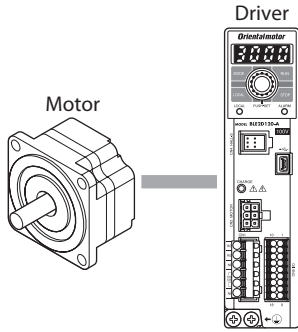

Operation using the external signals

The motor can be operated using the external signals or MEXE02.

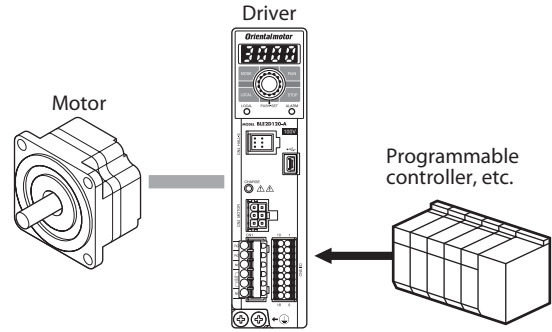

1. Operation using the operation panel

1 AC power ON

When the power supply is turned on, the display shows as follows.

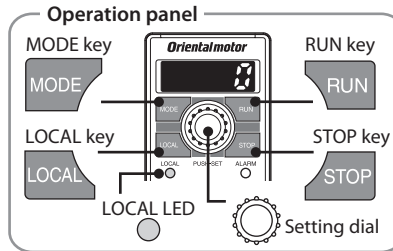
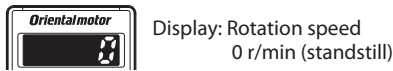

Refer to p.42 for details about the operation panel.

2 Operation selection

Press the LOCAL key.



The operation using the operation panel is set, and the rotation speed and rotation direction are alternately continued to show on the display.

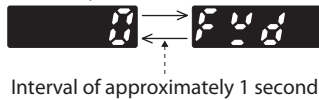

3 Rotation direction selection

Press the MODE key. The motor rotation direction changes whenever the MODE key is pressed.

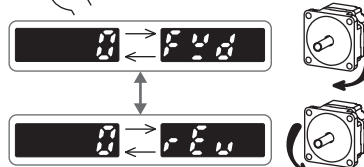

Check the operating manual supplied with the motor for the rotation direction of the gearhead output shaft.

* The figures show the round shaft type. In the case of the gearhead output shaft, the rotation direction varies depending on the gear ratio of the gearhead.

4 Start of motor

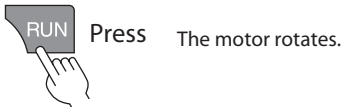

To stop the motor



5 Changing speed of motor [example: 50 to 1000 r/min]

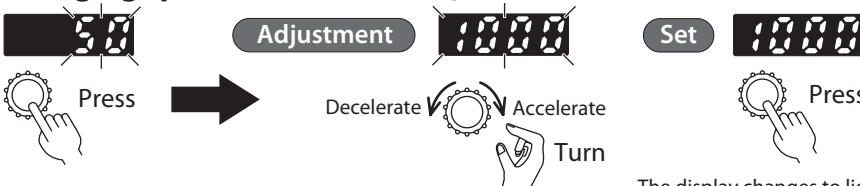

The display blinks. You can adjust the speed while blinking.

The display changes to lighting from blinking, and the speed will be set. When you start the motor next time, it will rotate at the set speed.

2. Operation using the external signals

2-1 Overview

The motor can be operated by setting up to 16 operation data and selecting the operation data number externally.

Operation data No.	Item	Setting range	Factory setting	Reference page
0 to 15	Rotation speed	50 to 4000 r/min	50	p.31
	Torque limiting	0 to 300%	300	p.35
	Acceleration time	0.0 to 15.0 s	0.5	p.37
	Deceleration time			

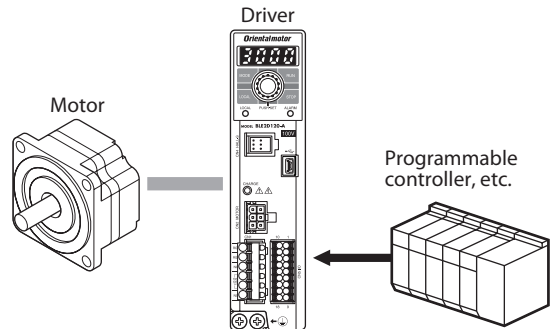

2-2 Setting method of the rotation speed

The rotation speed can be set by the following four methods.

Digital setting		Analog setting	
Operation panel	MEXE02	External potentiometer	External DC voltage
p.31	p.60	p.32	p.32

2-3 Procedures to set the rotation speed

2-3-1 When setting with the operation panel

Example: Set the rotation speed of the operation data No.0 to 1000 r/min.

- Turn on the AC power supply

Rotation speed : 0 r/min
- Press twice **MODE**

Press

Data No.0

Press

Data number selection screen
- Press

Rotation speed

Press

Operation data selection screen in the data number
- Press

Setting screen of rotation speed

50 r/min (factory setting)

Change to 1000 r/min

Turn
- Set (store) the data

Press

Press five times

[To return to the rotation speed display]

Press
- Refer to p.33 for the operating method.

For more details about the above procedure, check "Setting the operation data" of the operation panel on p.46.

2-3-2 When setting with the external potentiometer or external DC voltage

This is the procedure for when the rotation speed is set using the external potentiometer or external DC voltage after selecting the data No.1.

- 1** Check the connection
- 2** Turn on the AC power supply
- 3** Change the setting of the "Speed, torque limiting command selection" parameter (ID: 1820) to "1"

Press three times Parameter mode
- 4** Press twice ID input screen Turn clockwise to select 1820
- 5** Press [Parameter setting range]
0: Digital setting
1: Analog setting for the rotation speed of the operation data No.1
- 6** Turn clockwise to select 1 Press
- 7** Press once Turn clockwise to select Configuration
- 8** Press twice [To return to the rotation speed display]
 Press three times Press
- 9** Turn the M0 input ON to select the operation data No.1.
- 10** Determine the setting value by changing the DC voltage value

 - External DC voltage - Rotation speed characteristics (representative values)

The rotation speed can be set by the voltage range of 0 VDC to 10 VDC. ⇒ p.34

 - External potentiometer - Rotation speed characteristics (representative values)
- 11** Refer to p.33 for the operating method.

For more details about the above procedure, check "Setting the parameters" of the operation panel on p.47.

2-4 Operation/standstill using external signals

When the FWD input is turned ON, the motor rotates in the CW direction. The motor decelerates to a stop when the signal is turned OFF.

When the REV input is turned ON, the motor rotates in the CCW direction. The motor decelerates to a stop when the signal is turned OFF.

If both the FWD and REV inputs are turned ON, the motor decelerates to a stop.

This rotation direction is based on the factory setting of the "Motor rotation direction" parameter (ID: 450).

(Motor rotation direction: p.38)

The factory setting is 2-wire input mode. You can change to 3-wire input mode.

(Switching of the operation input mode: p.58)

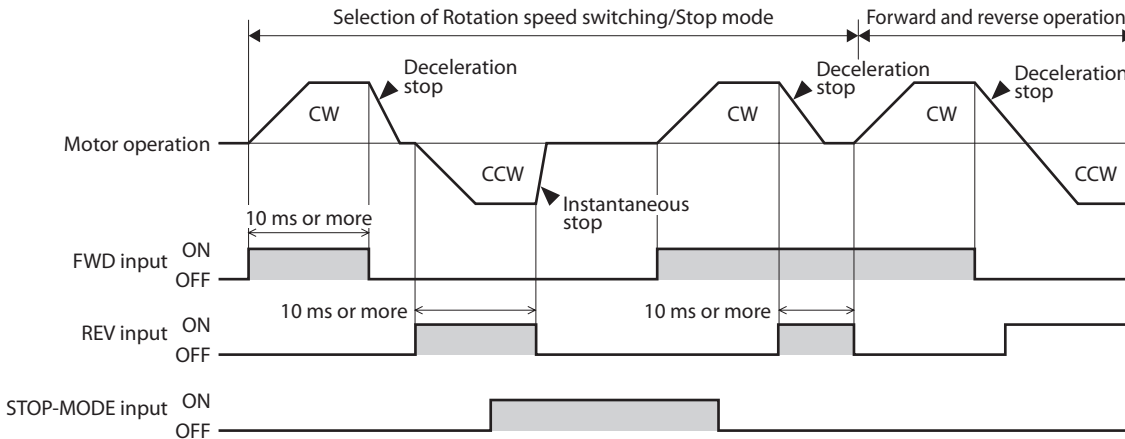

2-5 Examples of operation patterns

The charts below are an example for when setting the operation data No.0 to 3000 r/min and the operation data No.1 to 1000 r/min, and switching the speed between these two levels.

The rotation directions for the FWD input and REV input shown here are based on the factory setting of the "Motor rotation direction" parameter (ID: 450).

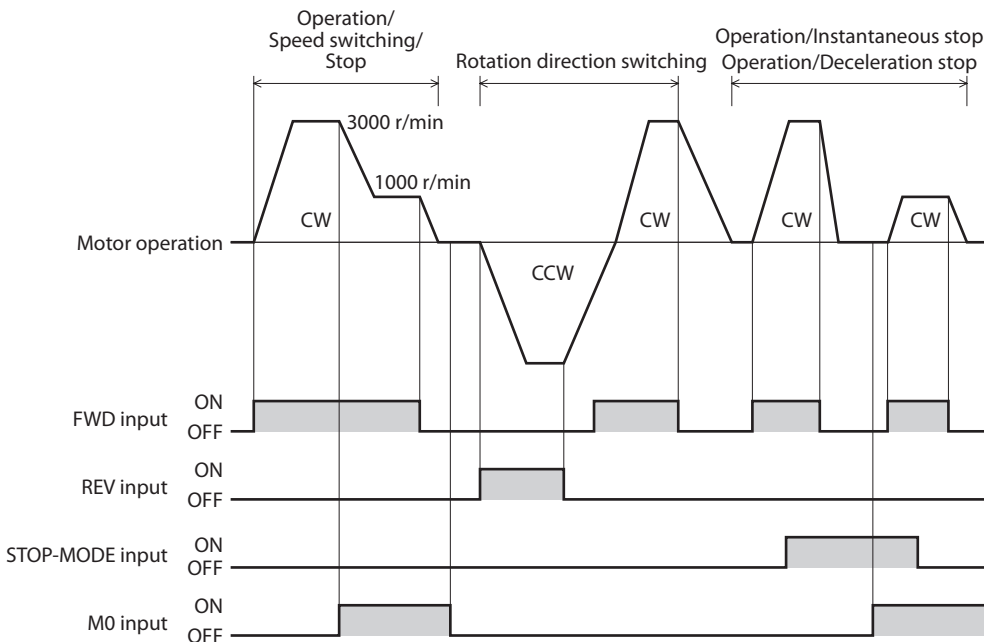

Note

- Make sure each signal remains ON for at least 10 ms.
- When switching the FWD input and REV input, provide an interval of at least 10 ms.

Refer to p.38 for the setting and operation for when operating two or more speeds.

2-6 Gain adjustment and offset adjustment for rotation speed

If the gain or offset is adjusted when the rotation speed is set using the external DC voltage or external potentiometer, the slope of the speed command can be changed and the speed can finely be adjusted.

Note The rotation speed corresponding to the voltage value varies depending on the product.

Gain adjustment and offset adjustment for rotation speed

Adjust using the following parameters.

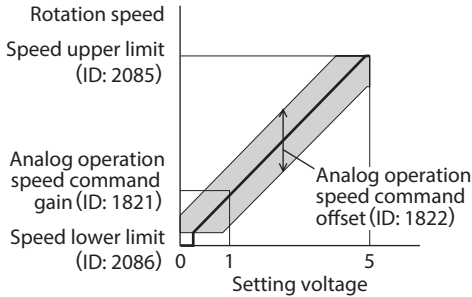

$$\text{Analog operation speed command} = \text{Analog operation speed command gain} \times \text{Setting voltage} + \text{Analog operation speed command offset}$$

Related parameters

ID	Parameter name	Description	Setting range	Factory setting
1821	Analog operation speed command gain	Sets the speed command per 1 VDC of the input voltage by the external analog setting device.	0 to 4000 r/min	850
1822	Analog operation speed command offset	Sets the offset of the speed command input by the external analog setting device.	-2000 to +2000 r/min	0
2085	Speed upper limit	Sets the upper limit value of the speed command.	50 to 4000 r/min	4000
2086	Speed lower limit*	Sets the lower limit value of the speed command.	50 to 4000 r/min	50

* Refer to p.54 for the setting of the speed lower limit.

Setting example 1:

When the motor is operated linearly by setting the maximum rotation speed to 4000 r/min using the external DC voltage of 0 to 10 VDC

Sets the "Analog operation speed command gain" parameter (ID: 1821) to 425.

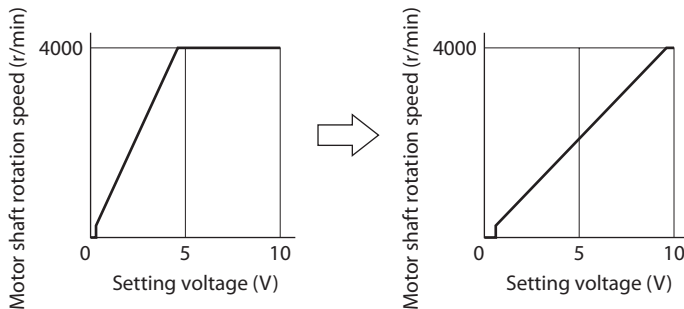

$$\text{Analog operation speed command gain}^* = \frac{\text{Speed upper limit}}{\text{Maximum value of setting voltage}}$$

* If the motor does not reach the speed upper limit when the setting voltage is the maximum value, increase the value in the analog operation speed command gain.

Setting example 2:

When the motor is operated linearly by setting the maximum rotation speed to 2000 r/min using the external DC voltage of 0 to 10 VDC

Set the "Speed upper limit" parameter (ID: 2085) to 2000 first, and then set the "Analog operation speed command gain" parameter (ID: 1821) to 213.

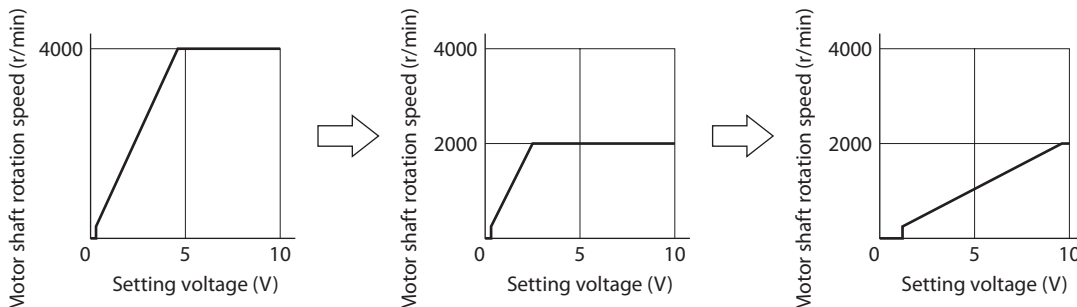

Refer to "How to adjust the speed difference" on p.40 for how to use the "Analog operation speed command offset" parameter (ID: 1822).

3. Setting of torque limiting

The maximum output torque of the motor can be limited. Set when the motor torque is suppressed for safe uses or it is limited according to the load.

[Setting range: 0 to 300%]

If the time to lock the motor shaft exceeds 5 seconds, use the torque limiting value at 50% or less.

If a large load inertia is stopped in a state where the maximum output torque is limited, the overvoltage information or the overvoltage alarm may be generated. Set the deceleration time longer.

■ Related I/O signals

● TL input

When the TL input is assigned to the input terminal, enable or disable of the torque limiting is switched by the ON-OFF status of the TL input.

When the TL input is being ON: The torque limiting function is enabled, and the maximum output torque of the motor is limited based on the set torque limiting value.

When the TL input is being OFF: The torque limiting function is disabled, and the maximum output torque of the motor is the maximum instantaneous torque.

Note When the TL input is not assigned to the input terminal, this input will be always set to ON. If the TL input is assigned to multiple input terminals, the function will be performed when all of the terminals are turned ON.

● TLC output

When the motor torque reaches the torque limiting value, the TLC output is turned ON.

Note If the torque limiting value is set to less than 20%, the TLC output may not be stable.

■ Setting method

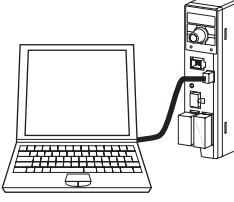
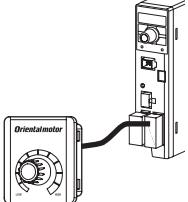
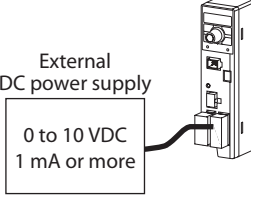
Digital setting		Analog setting	
Operation panel 	MEXE02 	External potentiometer 	External DC voltage  <p style="text-align: center;">External DC power supply 0 to 10 VDC 1 mA or more</p>

■ Setting procedures

Example: When the external DC voltage is used

1. Set the "Speed-torque limiting command selection" parameter (ID: 1820) to "3: Torque limiting is analog setting."
2. Connect a DC power supply.

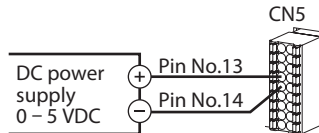

3. Set the torque limiting value by reference to the figure on the right.

● External DC voltage -Torque limiting characteristics (representative values)

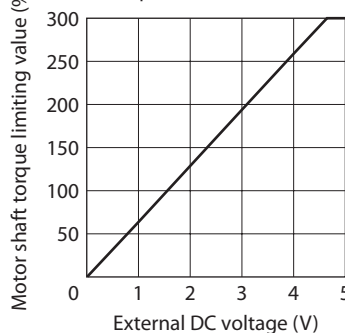

3-1 Gain adjustment and offset adjustment for torque limiting value

If the gain or offset is adjusted when the torque limiting value is set using the external DC voltage or external potentiometer, the slope of the command or lower limit can be set.

Note The torque limiting value corresponding to the voltage value varies depending on the product.

Gain adjustment and offset adjustment for torque limiting value

Adjust using the following parameters.

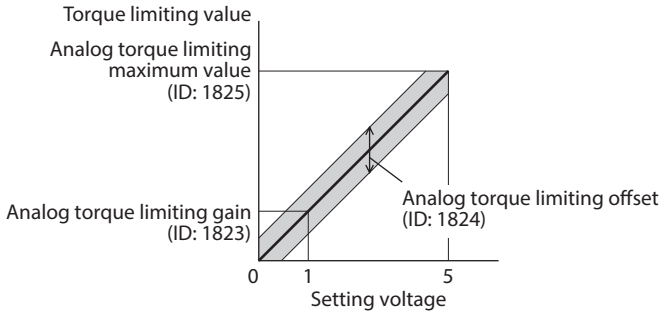

$$\text{Analog torque limiting gain}^* = \frac{\text{Analog torque limiting}}{\text{Maximum value of setting voltage}}$$

* If the motor does not reach the torque upper limit when the setting voltage is the maximum value, increase the value in the analog torque limiting gain.

Related parameters

ID	Parameter name	Description	Setting range	Factory setting
1823	Analog torque limiting gain	Sets the torque limiting value per 1 VDC of the input voltage by the external analog setting device.	0 to 300%/V	65
1824	Analog torque limiting offset	Sets the offset of the torque limiting input by the external analog setting device.	-150 to +150%	0
1825	Analog torque limiting maximum value	Sets the maximum value of the torque limiting by the external analog setting device.	0 to 300%	300

Setting example:

When adjusting the torque limiting value up to 300% using the external DC voltage of 0 to 10 VDC

Sets the "Analog torque limiting gain" parameter (ID: 1823) to 32.

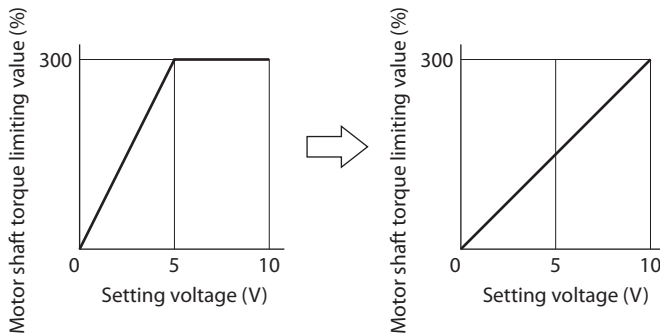

4. Setting of acceleration/deceleration time

The acceleration time and deceleration time can be set to prevent the load from receiving a shock upon starting or stopping. Setting range: 0.0 to 15.0 seconds (factory setting: 0.5 seconds)

Acceleration time refers to the time needed for the motor to reach the rated speed (3000 r/min) from the standstill status.

Deceleration time refers to the time needed for the motor to stop from the rated speed (3000 r/min).

The actual acceleration time and deceleration time vary depending on the conditions of use, load inertia, load torque, etc. If smooth acceleration or deceleration cannot be performed, review the acceleration time or deceleration time.

■ About motor movement

If the acceleration time and deceleration time is set to 0 second, the motor moves at a longer time than setting.

If they are set more than 0.1 seconds, the motor can move at the set time. (With no load)

If the frictional load or inertial load becomes larger, the moving time against the setting tends to be longer.

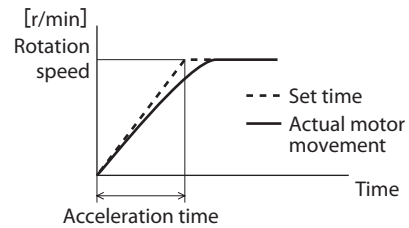
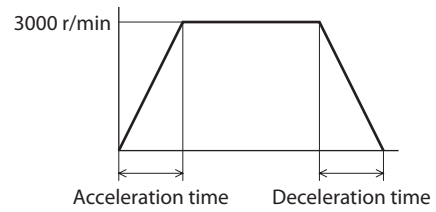

■ Setting method

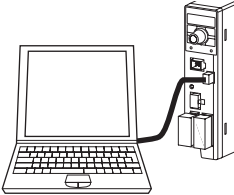
Digital setting	
Operation panel  p.46	MEXE02  p.60

- If the rotation speed is set by the digital setting, the acceleration time and deceleration time can be set by the time needed to reach the set speed. Refer to p.57 for details.

5. Setting of the rotation direction

■ Rotation direction of the motor output shaft

The rotation direction of the motor output shaft represents the direction when viewed from the motor output shaft.
The rotation direction can be changed by the parameter.

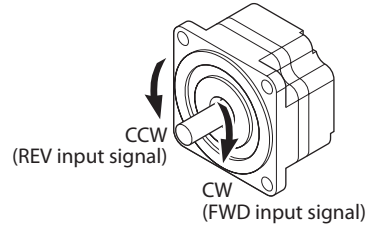

Related parameters

ID	Parameter name	Description	Setting range	Factory setting
450	Motor rotation direction	Sets the rotation direction of the motor output shaft when inputting the FWD input.	0: Positive direction=CCW 1: Positive direction=CW	1

Rotation direction of the gearhead output shaft

The rotation direction of the gearhead output shaft varies depending on the type or the gear ratio of the gearhead.
Check the operating manual supplied with the motor for the rotation direction of the gearhead output shaft.

■ Rotation direction for when performing the local control operation

During the local control operation, the rotation direction is continuously displayed blinking when the motor is at standstill.
At this time, the motor rotation direction can be changed by pressing **MODE** key.



In case of FWD: (Factory setting)

In case of REV:

Local control operation: Using 3 keys of **LOCAL**, **RUN**, and **STOP**, the motor can be operated.

6. Operating in two or more speeds (multi-speed operation)

The multi-speed operation can be performed by setting the rotation speed and switching the ON-OFF status of the M0 to M3 inputs.
When the M0 to M3 inputs are assigned to the CN5, the variable-speed operation can be performed using up to 16 operation data.

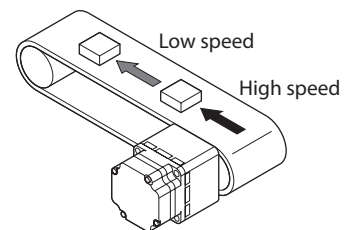

■ Data setting method (example: Rotation speed)

1 Turn on the AC power supply
Rotation speed : 0 r/min

2 Press twice MODE key
Data mode

3 Press Setting dial
Data number selection screen
Data No.0 : 00
The desired operation data number can be selected from the operation data No.0 to No.15 (16 data) by turning the dial.

4 Press Setting dial
Data No.0 selection screen
The desired item can be selected by turning the dial.

- Rotation speed **50**
- Torque limiting value **6.0**
- Acceleration time **2.0**
- Deceleration time **2.0**
- Initialization **0**

5 Press Setting dial
Setting screen
Rotation speed: 50 r/min (factory setting)
The display blinks

6 Turn Setting dial
Setting
Continue to turn clockwise until "1000"
The display blinks

7 Press Setting dial
Data setting
Blinks a few times fast

8 Press once MODE key
Data number selection screen
[To return to the rotation speed display]
MODE key Press four times → [1000] → Setting dial Press

■ Operation method (example: In case of four speeds)

Select any of the operation data No.0 to No.3 by switching the ON-OFF status of the M0 and M1 inputs, and operate the motor. The motor is operated using the rotation speed, torque limiting value, acceleration time, and deceleration time in the selected operation data number.

<<Operation procedure>>

1. Select the operation data number using the M0 and M1 inputs.
2. When either the FWD input or REV input is turned ON, the motor rotates.
3. Switch the operation data using the M0 and M1 inputs.
4. When the FWD input or REV input which has been turned ON is turned OFF, the motor stops.

Operation data No.	M1	M0
0	OFF	OFF
1	OFF	ON
2	ON	OFF
3	ON	ON

The setting method of the rotation speed can be selected with the setting of the "Speed, torque limiting command selection" parameter (ID: 1820). Refer to p.53 for details.

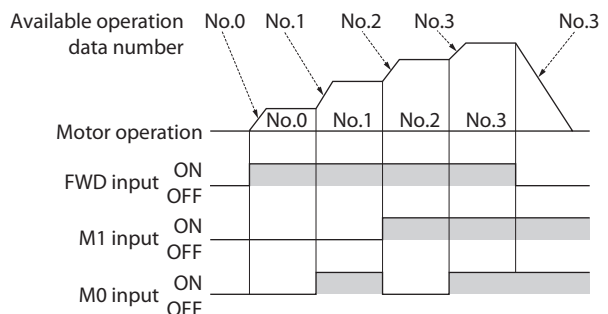

7. Adjusting the rotation speed of two or more motors by a single setting device (multi-motor control)

Multiple motors can be operated at the same speed using a single variable resistor or external DC voltage.

- Change the "Speed, torque limiting command selection" parameter (ID: 1820) to "1" or "2" of the analog setting when operating in this method.
When setting to "1": Selecting the data No.1 makes the rotation speed the analog setting.
When setting to "2": Selecting any of the data numbers makes the rotation speed the analog setting.
- A connection example shown below applies to products for the single-phase specifications. In the case of products for the three-phase specifications, connect the power supply line to three-phase power supply. Connections of motors and I/O signals are omitted in the figure.

■ When using a variable resistor

Connect the drivers as shown below.

When using a variable resistor, operate products of 20 units or less.

Calculation method of resistance (VRx) for when the number of drivers is n

Resistance (VRx) = 20/n (kΩ), n/20 (W)

Example: If two drivers are used

Resistance (VRx) = 20/2 (kΩ), 2/20 (W)

Therefore, the resistance is calculated as 10 kΩ, 1/10 W.

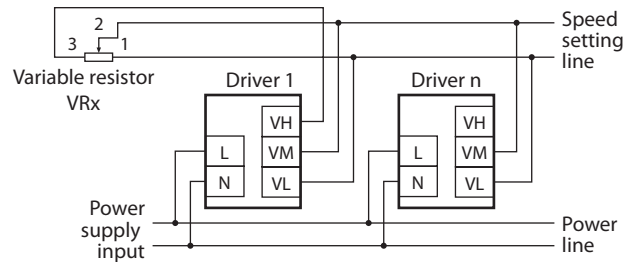

■ When using external DC voltage

Connect the drivers as shown below.

Calculation method of current capacity (I) of external DC power supply when the number of drivers is n

Current capacity (I) = 1 × n (mA)

Example: If two drivers are used

Current capacity (I) = 1 × 2 (mA)

Therefore, the current capacity is calculated as 2 mA or more.

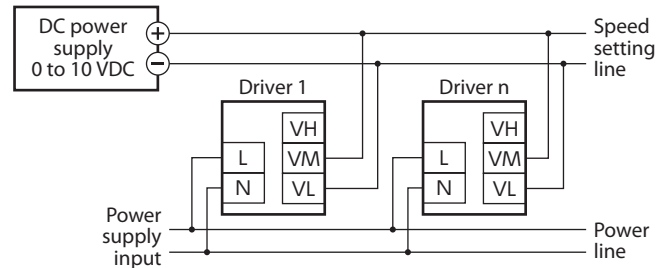

■ How to adjust the speed difference

To adjust the speed difference among the first motor and the second and subsequent motors, change the parameter or connect a resistor to adjust.

● Adjustment by the parameter

The speed difference can be adjusted by changing the "Analog operation speed command gain" parameter (ID: 1821) and "Analog operation speed command offset" parameter (ID: 1822) for the second and subsequent drivers. This section explains how to adjust by the "Analog operation speed command offset" parameter.

Refer to p.54 for how to set the parameter.

- When the speed of the second motor is slower than that of the first motor:
Set the offset value to rotate faster (positive side) by the "Analog operation speed command offset" parameter.
- When the speed of the second motor is faster than that of the first motor:
Set the offset value to rotate slower (negative side) by the "Analog operation speed command offset" parameter.

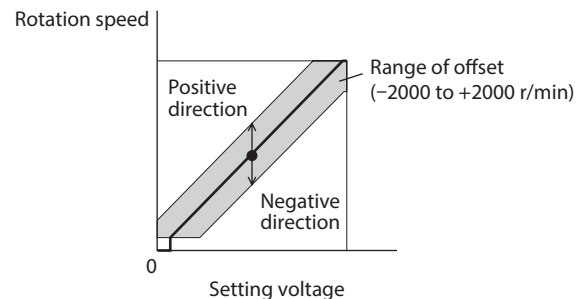

● Adjustment by a resistor

Connect a resistor of 470 Ω, 1/20 W to the terminal VM on the driver 1 and connect a variable resistor VRn of 1 kΩ, 1/20 W to the driver 2 and subsequent drivers.

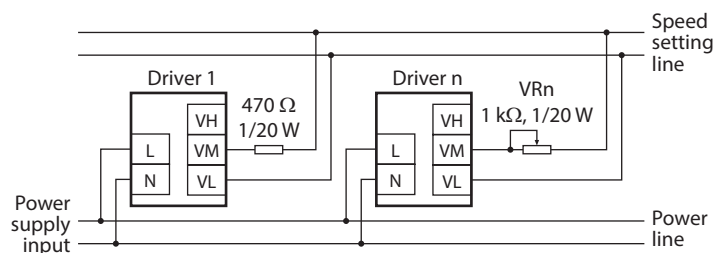

Convenient functions

Display

Displaying the rotation speed of the gearhead output shaft	p.52
Displaying the transfer speed of the conveyor drive	p.52
Displaying the speed increased by an external mechanism	p.52
Displaying the motor output torque	p.44
Displaying the operation data number presently selected	p.44
Changing the display at power ON	p.59

Speed setting

Changing the setting method of the rotation speed	p.53
Setting the rotation speed with the teaching operation	p.45
Operating in two or more speeds	p.38
Limiting the setting range of the rotation speed	p.54
Checking the setting value of the external speed setting device	p.44

Application

Holding a load by the slight position-keeping function at motor standstill	p.57
Softening an impact at starting and stopping	p.57
Changing the motor rotation direction with the FWD input	p.38
Operating the motor by ON-OFF control of the power supply	p.55

Input and output

Changing the functions of input signals	p.59
Changing the functions of output signals	p.59
Checking the ON-OFF status of input signals	p.44
Checking the ON-OFF status of output signals	p.44
Testing the status of I/O signals	p.48
Changing the operation input mode from the 2-wire input mode to the 3-wire input mode	p.58

Alarm Information

Resetting the alarm that is present	p.70
Changing the overload alarm detection time	p.55
Checking the alarm records that were occurred	p.44
Checking the information contents that were occurred	p.44
Changing the generation condition or output setting of information	p.55

Lock

Locking so that the setting is not changed with the operation panel	p.49
---------------------------------------------------------------------	------

Operation panel

This chapter explains how to set data and how to operate a motor using the operation panel on the driver.

1. Operation panel

This section explains the name and function of each part of the operation panel as well as function modes.

1-1 Names and functions of parts

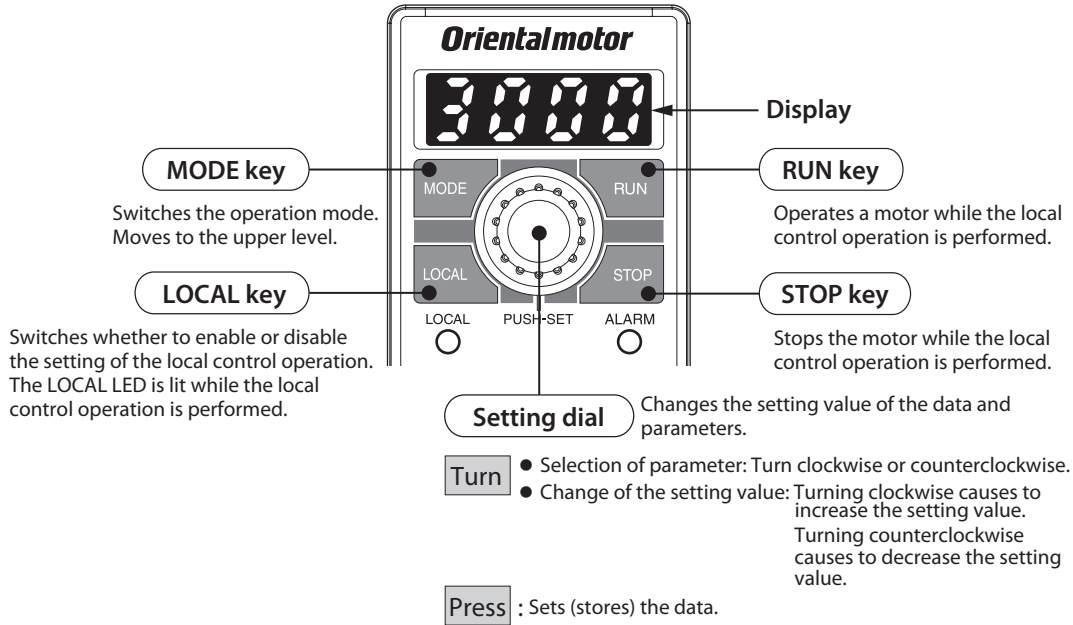

- Local control operation: This is a method to operate using the operation panel.
Remote control operation: This is the method to operate using the external signals or **MEXE02**.
- The local control operation can be enabled when the monitor mode is selected.
If the LOCAL key is pressed when the other operation mode is selected, "Err" is displayed.
 - The operating method is described on p.30.

The operation panel cannot remove from the driver.

1-2 How to read the display

The display shows as follows.

• Arabic number



• Alphabet

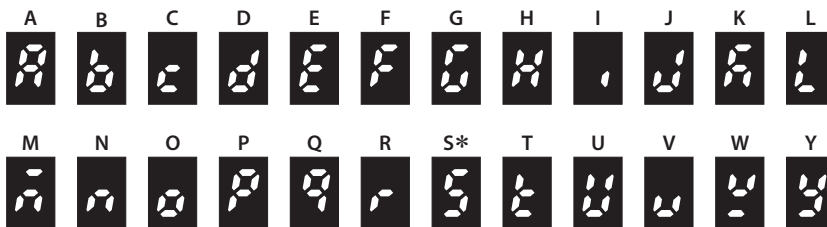

• Sign



* Arabic number "5" and alphabet "S" are the same sign.

1-3 Function mode types

There are four operation modes in this product.

On the top screen of each mode, pressing the **MODE** key or turning the setting dial will cause to switch the operation mode. The top screens for each mode are as follows.

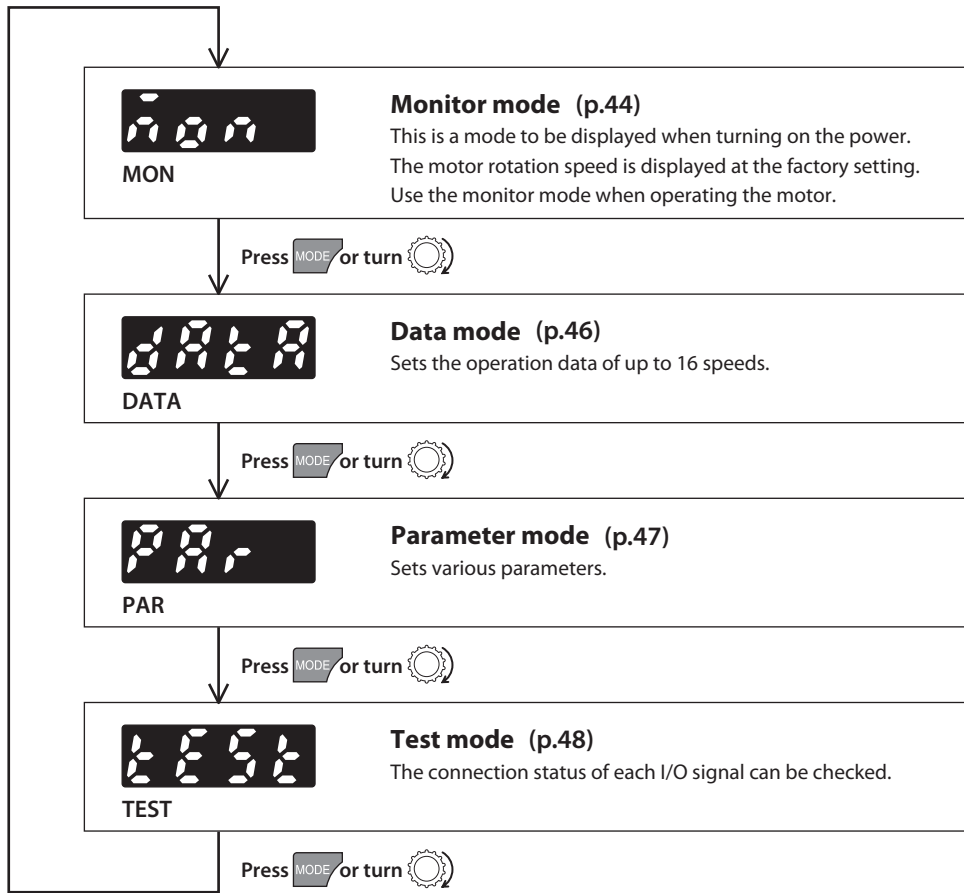

2. Operation transitions

2-1 Items which can be monitored

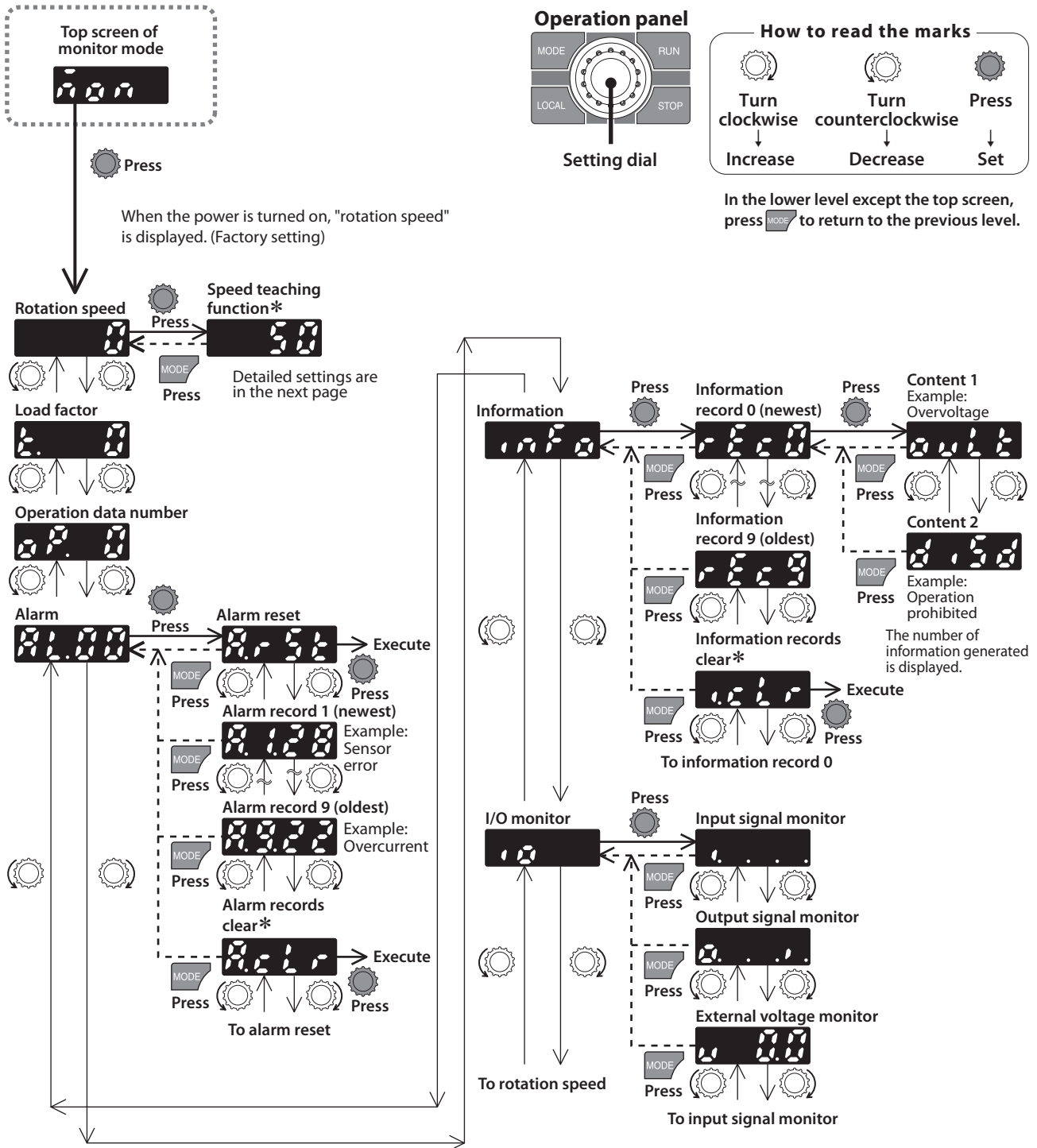

* "Speed teaching function" "Alarm records clear" "Information records clear":

When operations are limited by the edit lock function, you cannot execute since these screen are not displayed.

■ Rotation speed

The motor rotation speed can be checked.

The rotation speed can be displayed as the rotation speed of the gearhead output shaft. To do this, set in the "Speed reduction ratio" parameter (ID: 2033) and "Speed reduction ratio digit setting" parameter (ID: 2038).

It is also possible to increase the rotation speed and display the increased speed. Set in the "Speed increasing ratio" parameter (ID: 2039).



When the "Speed increasing ratio" parameter is set to 1.00, the speed reduction ratio will be effective. When the "Speed increasing ratio" parameter is set to other than 1.00, the speed increasing ratio will be effective.

● Speed teaching function

In the monitor mode, the rotation speed of the data number presently being operated can be changed while the motor is rotating. The speed teaching function cannot be used when the rotation speed is set using an external potentiometer or external DC voltage.

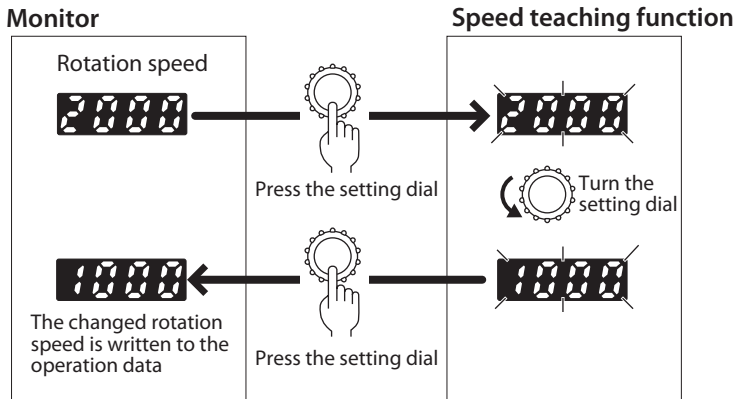

■ Load factor

The motor generating torque can be checked. The present load factor is displayed based on the rated torque being 100%.

■ Operation data No.

The operation data number presently being operated can be checked.

■ Alarms

If an alarm generates, 2-digit alarm code is displayed.

The present alarm can be reset, and also alarm records can be checked and cleared.

Refer to p.70 for the causes or actions of the alarm.

■ Information

Descriptions of the information presently being generated can be checked.

Also, information records can be checked and cleared.

Refer to p.72 for details about the information.

- When the "INFO auto clear" parameter (ID: 447) is set to disable

The screen to release the information is shown after information records clear, and the release is executed when pressing the setting dial.

■ I/O monitor

The ON-OFF status of I/O signals for the driver can be checked.

Each digit on the 7-segment LED display corresponds to a signal. The corresponding digit is lit when the signal is ON, and the digit is unlit when the signal is OFF.

Also, the voltage value that was set using an external potentiometer or external DC voltage can be checked.

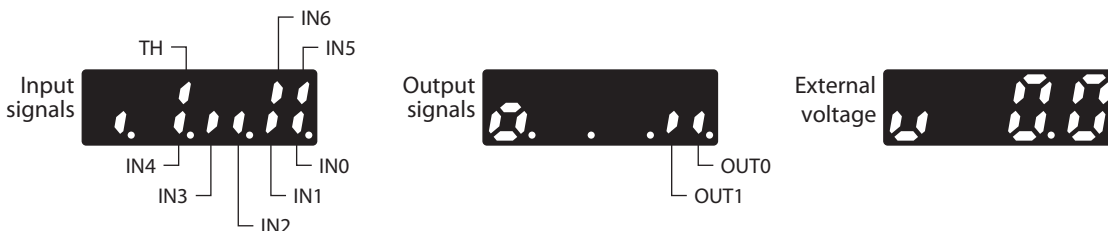

2-2 Setting the operation data

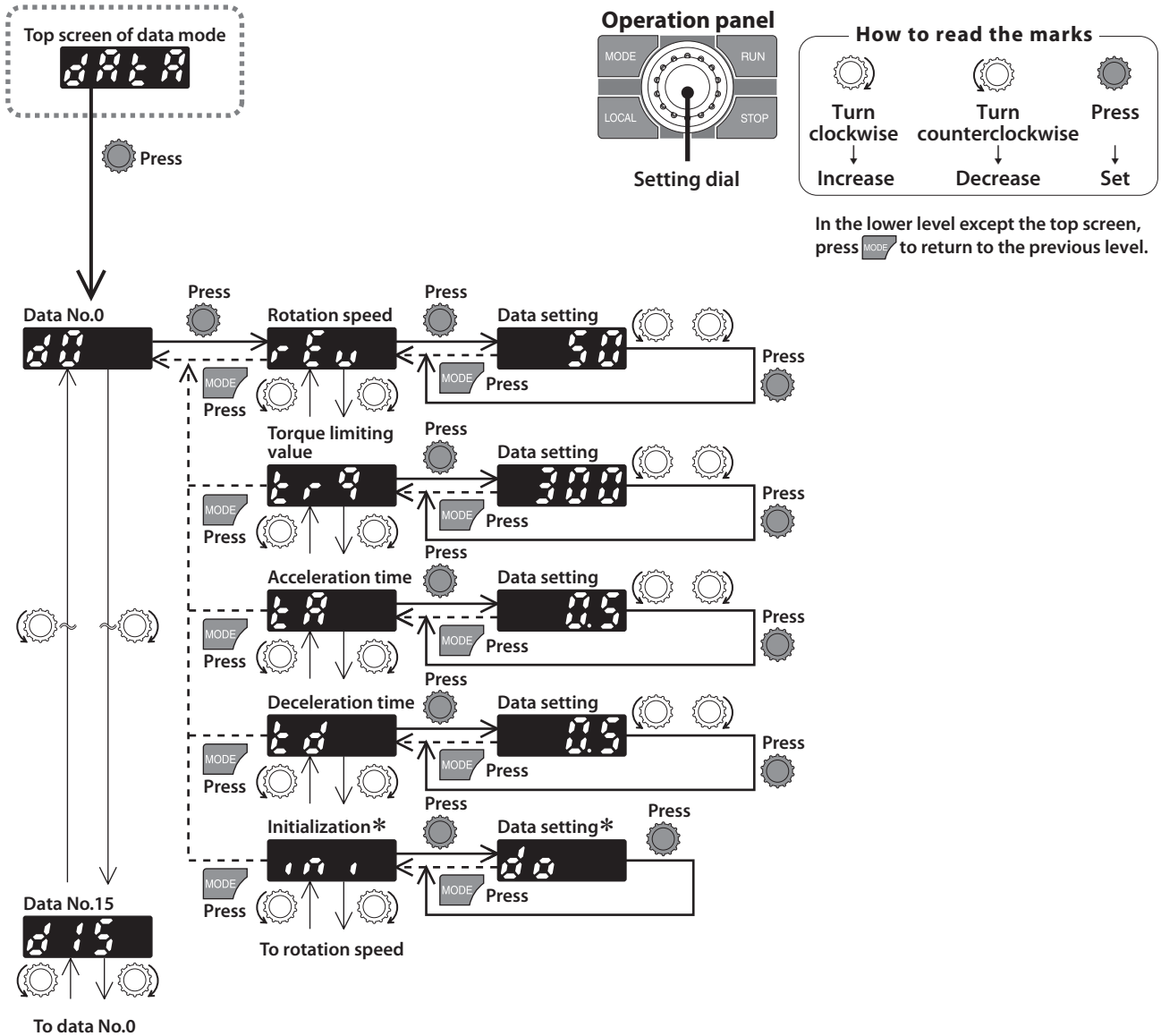

* "Initialization": When operations are limited by the edit lock function, you cannot execute since the screen is not displayed.

● Setting item

Item	Connection	Setting range	Setting unit	Factory setting
Rotation speed	Set the motor rotation speed. Even if the "speed reduction ratio" or "speed increasing ratio" is set, set the rotation speed according to the motor shaft.	50 to 4000 r/min	1	50
Torque limiting value	Set if the output torque is limited while the motor rotates. Set the maximum torque based on the motor rated torque being 100%.	0 to 300%	1	300
Acceleration time	Set the acceleration time as the time needed for the motor to reach the rated rotation speed (3000 r/min) from the standstill state. If the acceleration time needed to reach the setting speed is set, change the value of the "Acceleration/deceleration unit selection" parameter to "1."	0.0 to 15.0 s	0.1	0.5
Deceleration time	Set the deceleration time as the time needed for the motor to stop from the rated rotation speed (3000 r/min). If the deceleration time needed to stop from the speed being rotated is set, change the value of the "Acceleration/deceleration unit selection" parameter to "1."			
Initialization	Restore the data for each data number to the factory setting.	-	-	-

2-3 Setting the parameters

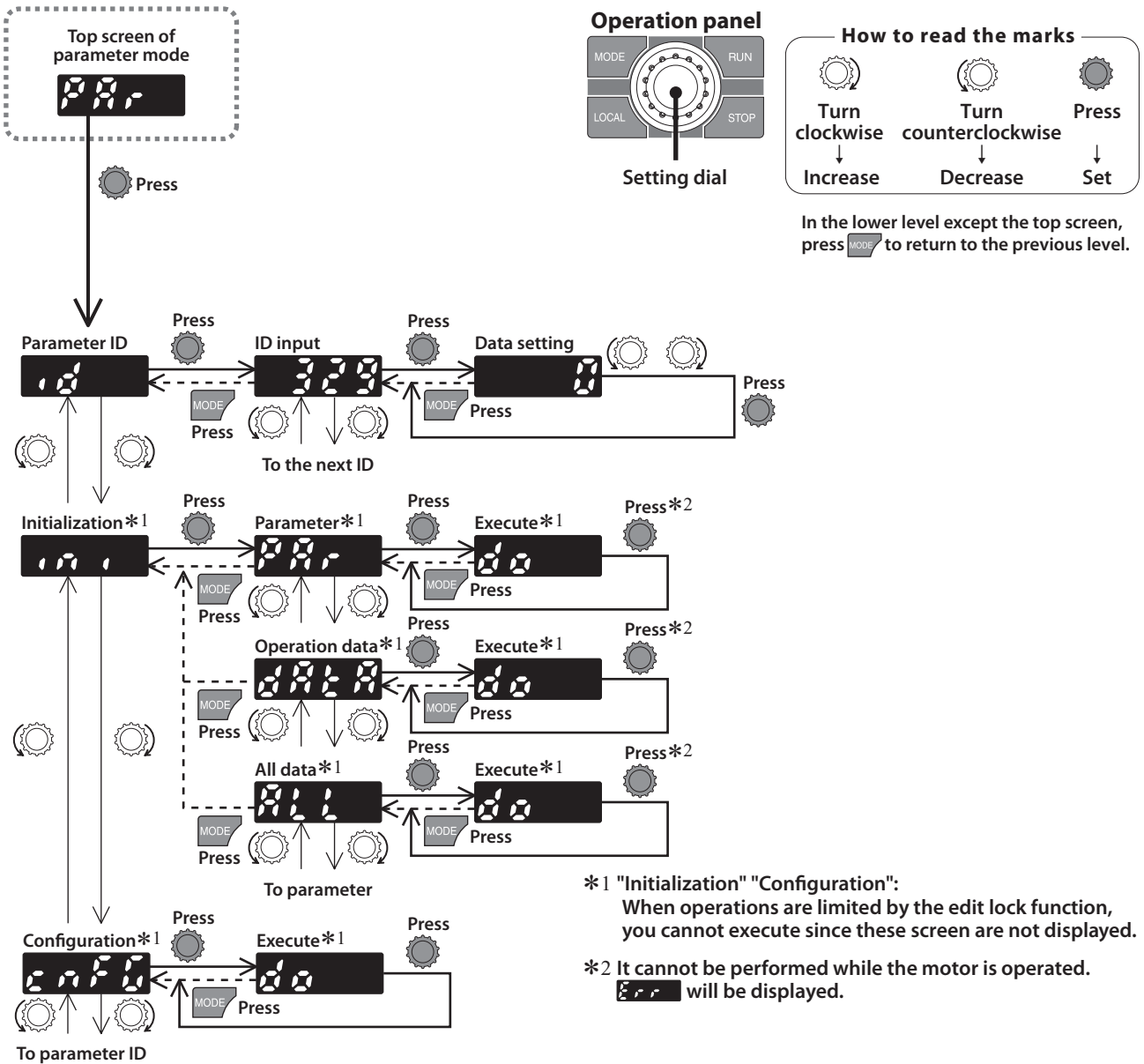

Parameter ID

There is a unique ID in each parameter. Input the ID and set. Refer to p.50 for parameter ID.

[Setting method of the parameter selecting a sign]

Selecting a sign after setting ID and pressing the setting dial will appear the data setting screen.

[Setting method of the parameter possible to set up to 9 digits]

The operation panel is of 4-digit LEDs, so input the setting value of up to 9 digits by dividing into an "upper," "middle," and "lower."

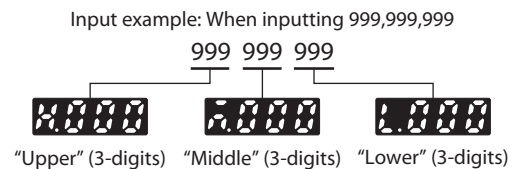

Initialization

Restore the data stored in the driver to the factory setting. Selecting any of the operating data only, parameter only or all data, the data can be restored to the factory setting.

Configuration

By executing Configuration, the parameters that the timing to become effective is set to "C: Configuration" can be applied to the driver setting.

2-4 Test mode

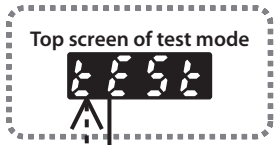

Press

MODE
Press



Press

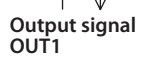
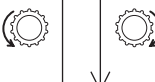

To input signal

Operation panel



Setting dial

How to read the marks

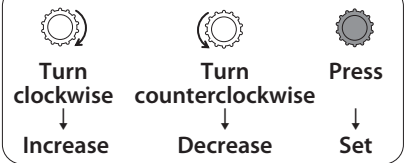

In the lower level except the top screen, press **MODE** to return to the previous level.

When pressing the setting dial while operating a motor

It cannot move to the setting screen of the test mode while operating.

An error occurs even when the setting dial is pressed, and is displayed.

Be sure to stop the motor operation before pressing the setting dial.

I/O test

With the I/O test, the ON-OFF status of each input signal can be checked and the ON-OFF status of each output signal can be switched.

The ALARM LED on the driver blinks in orange when the screen is moved to the I/O test.

The motor does not rotate while the I/O test is performed.



If you switch to the I/O test by pressing the setting dial while the slight position-keeping function is enabled, the holding force is lost.

When the screen is returned to the top screen of test mode, the holding force is generated.

Input signal

Each digit on the 7-segment LED display corresponds to a signal.

The corresponding digit is lit when the signal is ON, and the digit is unlit when the signal is OFF.

The connection with a programmable controller can be checked.

In this time, the motor does not rotate even if the input signal is turned ON.

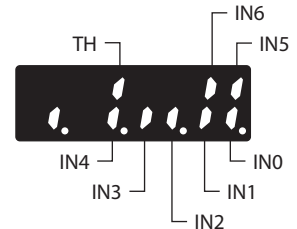

Output signal

The ON-OFF status of the output signal can be switched using the setting dial.

External voltage

The voltage value input by the external analog setting device can also be checked.

3. Edit lock function

This is a function to prohibit the local control operation in addition to editing and erasing of data and parameters by the operation panel.

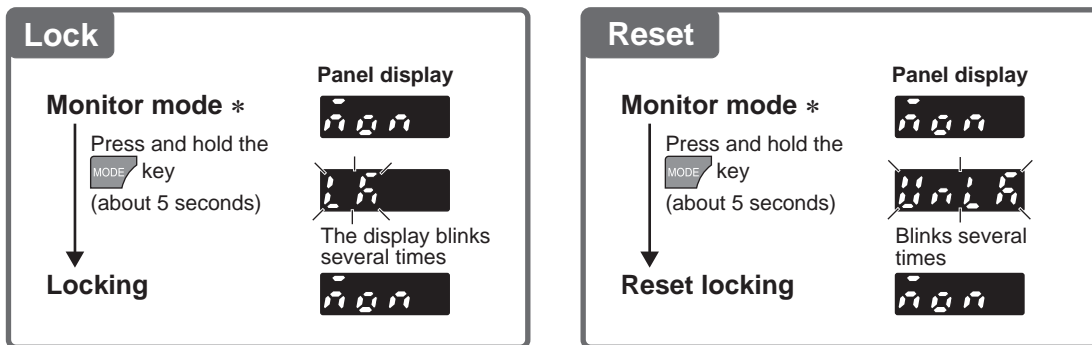

* The edit lock function can be set when the top screen of each mode is displayed.

Display for when the edit lock function is enabled

If the setting value of the operation data or parameter is tried to change while the edit lock function is enabled, " " is displayed for about one second.

Parameter

1. Parameter list

ID	Parameter name	Description	Setting range	Factory setting	Effective*1
–	Driver user name	The desired name can be given to the driver used. (Possible to set by using only the MEXE02)	Up to 16 characters	–	A
1820	Speed, torque limiting command selection	Selects the setting method of the rotation speed and torque limiting value. Refer to the table on p.53 for the setting range.	0: Digital setting 1: Analog setting for the speed No.1, and digital setting for others 2: Analog setting for speed, and digital setting for torque limiting 3: Digital setting for speed, and analog setting for torque limiting	0	C
2033	Speed reduction ratio	If the speed reduction ratio is set, the converted rotation speed is displayed.	100 to 9999	100	A
2038	Speed reduction ratio digit setting	Sets the speed reduction ratio using the formula of "speed reduction ratio" x "speed reduction ratio digit setting."	0: ×1 1: ×0.1 2: ×0.01	2	A
2039	Speed increasing ratio	If the speed increasing ratio is set, the converted rotation speed is displayed.	1.00 to 2.00	1.00	A
450	Motor rotation direction	Sets the rotation direction of the motor output shaft when inputting the FWD input.	0: Positive direction=CCW 1: Positive direction=CW	1	C
2085	Speed upper limit	Sets the upper limit value of the speed command.	50 to 4000 [r/min]	4000	B
2086	Speed lower limit	Sets the lower limit value of the speed command.	50 to 4000 [r/min]	50	
1821	Analog operation speed command gain	Sets the speed command per 1 VDC of the input voltage by the external analog setting device.	0 to 4000 [r/min/V]	850	A
1822	Analog operation speed command offset	Sets the offset of the speed command input by the external analog setting device.	–2000 to +2000 [r/min]	0	
1823	Analog torque limiting gain	Sets the torque limiting value per 1 VDC of the input voltage by the external analog setting device.	0 to 300 [%/V]	65	
1824	Analog torque limiting offset	Sets the offset of the torque limiting input by the external analog setting device.	–150 to +150 [%]	0	
1825	Analog torque limiting maximum value	Sets the maximum value of the torque limiting by the external analog setting device.	0 to 300 [%]	300	
384	Overload alarm detection time	Sets the detection time of the overload alarm. 200 W or lower: at a time of about 180% load 300 W or higher: at a time of about 150% load	0.1 to 40.0 [s]	30.0	A
413	Reserved	Not used	–	–	–
414	Prevention of operation at power-on alarm	Sets whether to enable or disable the "prevention of operation at power-on alarm." Refer to p.70 for alarms.	0: Disable 1: Enable	1	C
416	Driver temperature information*2	Sets the generation condition of the driver temperature information.	40 to 85 [°C]	85	A
418	Speed information*2	Sets the generation condition of the speed information.	50 to 5000 [r/min]	5000	
422	Load information	Sets the generation condition of the load information.	10 to 300 [%]	300	
425	Overvoltage information	Sets the generation condition of the overvoltage information.	280 to 440 [V]	435	
426	Undervoltage information	Sets the generation condition of the undervoltage information.	120 to 280 [V]	120	
431	Tripmeter information*2	Sets the generation condition of the tripmeter information.	0: Disable 1 to 999,999,999 (1=0.1 kRev)	0	
432	Odometer information*2	Sets the generation condition of the odometer information.	0: Disable 1 to 999,999,999 (1=0.1 kRev)	0	

*1 Timing to become effective

A: Effective immediately (Executes the recalculation and setup immediately when writing the parameter.)

B: Effective after stopping the operation (Executes the recalculation and setup after stopping the operation.)

C: Effective after executing the configuration or turning the power ON again

(Executes the recalculation and setup after executing the configuration or turning the power ON again.)

D: Effective after turning the power ON again (Executes the recalculation and setup after turning on the power again.)

*2 It is effective for drivers Ver.2.00 or later.

ID	Parameter name	Description	Setting range	Factory setting	Effective*1
438	Main power supply time information*2	Sets the generation condition of the main power supply time information.	0: Disable 1 to 999,999,999 [min]	0	A
439	Main power supply count information*2	Sets the generation condition of the main power supply count information.	0: Disable 1 to 999,999,999 [times]	0	
447	INFO auto clear	Sets whether a state of generating information is automatically cleared when the cause generated the information was removed.	0: Disable 1: Enable	1	
1954 to 1983	INFO action (Driver temperature information (INFO-DRVTMP))*3 to INFO action (Power cycling request information (INFO-RBT))*3	You can set whether to turn the INFO output ON or OFF in each INFO action parameter. Refer to p.55 for details.	0: INFO action is not applied 1: INFO action is applied	1	
2069	Slight position-keeping function selection	Sets whether the holding force of about 50% of the rated torque is generated when the motor stops.	0: Disable 1: Enable	0	C
329	Acceleration/deceleration unit selection	Sets the setting unit for the acceleration time and deceleration time for when setting the rotation speed to the digital setting.	0: [s / 3000 r/min] 1: [s]	0	B
330	Impact softening filter	This is a function to soften an impact at starting and stopping against the set acceleration time and deceleration time.	0: No filter 1: Filter 1 2: Filter 2	0	
1819	Operation input mode selection	Selects 2-wire input mode or 3-wire input mode. Some operation patterns of operation input signals can be changed.	0: 2-wire input mode 1 1: 3-wire input mode 1 2: 2-wire input mode 2 3: 2-wire input mode 3 4: 3-wire input mode 2 5: 3-wire input mode 3	0	C
1817	VA detection width	Sets the output width of the VA output.	1 to 400 [r/min]	200	A
2112	IN0 input function selection	Assigns the input signals to the input terminal IN0 to IN6.	0: Not used, 8: ALARM-RESET 14: INFO-CLR, 16: HMI 22: TL, 25: EXT-ERROR 58: FWD (START/STOP) 59: REV (RUN/BRAKE) 64: M0, 65: M1 66: M2, 67: M3 72: STOP-MODE (CW/CCW) 73: MB-FREE*4, 74: H-FREE	58	C
2113	IN1 input function selection			59	
2114	IN2 input function selection			72	
2115	IN3 input function selection			64	
2116	IN4 input function selection			65	
2117	IN5 input function selection			8	
2118	IN6 input function selection	73			
2128 to 2134	IN0 logic level setting to IN6 logic level setting	Sets the logic level setting of input signals.	0: Non invert 1: Invert	0	
2144	OUT0 output function selection	Assigns the output signals to the output terminals OUT0 and OUT1.	0: Not used, 130: ALARM-OUT 134: MOVE, 135: INFO 140: TLC, 141: VA 147: SPEED-OUT, 148: DIR	147	
2145	OUT1 output function selection			130	
2160	OUT0 logic level setting	Sets the logic level setting of output signals.	0: Non invert 1: Invert	0	
2161	OUT1 logic level setting				
488	Operation panel editing	Editing on the operation panel can be disabled. Switching to the local control operation cannot be performed if it is disabled.	0: Disable 1: Enable	1	A
489	Operation panel initial view	Sets the initial screen to display on the operation panel when the driver power is turned on.	0: Rotation speed [r/min] 1: Load factor [%] 2: Operation data number	0	
498	USB-ID enable	Sets whether to enable or disable the USB-ID (serial number).	0: Disable 1: Enable	1	D
499	USB-ID	Sets the USB-ID (serial number).	0 to 999,999,999	0	
2555	USB-PID	Sets the ID to be displayed in the COM port.	0 to 31	0	

*1 Timing to become effective

A: Effective immediately (Executes the recalculation and setup immediately when writing the parameter.)

B: Effective after stopping the operation (Executes the recalculation and setup after stopping the operation.)

C: Effective after executing the configuration or turning the power ON again

(Executes the recalculation and setup after executing the configuration or turning the power ON again.)

D: Effective after turning the power ON again (Executes the recalculation and setup after turning on the power again.)

*2 It is effective for drivers Ver.2.00 or later.

*3 It is effective for drivers Ver.3.00 or later.

*4 Not used

2. Timing for parameter to become effective

Parameters are set using the operation panel or **MEXE02**.

When parameters are written to the driver, they are saved in the non-volatile memory. The parameters saved in the non-volatile memory are stored even after the power supply is turned off. When a parameter is changed, the timing to enable the new value varies depending on the parameter. See the following four types.

- Effective immediatelyThe recalculation and setup are immediately executed when writing the parameter.
- Effective after stopping the operationThe recalculation and setup are executed when stopping the operation.
- Effective after executing the configuration.....The recalculation and setup are executed after executing the configuration.
The configuration is executed using the parameter mode of the operation panel or the **MEXE02**.
- Effective after turning the power ON againThe recalculation and setup are executed after turning on the power again.

■ Notation rules

In this document, each update timing is represented in an alphabetical character.

A: Effective immediately

B: Effective after stopping the operation

C: Effective after executing the configuration or turning the power ON again

D: Effective after turning the power ON again

3. Explanation of parameters

3-1 Basic setting parameters

A: Effective immediately, C: Effective after executing the configuration

ID	Parameter name	Description	Setting range	Factory setting	Effective
–	Driver user name	The desired name can be given to the driver used. (Setting by using the MEXE02 only)	Up to 16 characters	–	A
1820	Speed, torque limiting command selection	Selects the setting method of the rotation speed and torque limiting value.	0: Digital setting 1: Analog setting for the speed No.1, digital setting for others 2: Analog setting for speed, digital setting for torque limiting 3: Digital setting for speed, analog setting for torque limiting	0	C
2033	Speed reduction ratio	If the speed reduction ratio is set, the converted rotation speed is displayed.	100 to 9999	100	A
2038	Speed reduction ratio digit setting	Sets the speed reduction ratio using the formula ["Speed reduction ratio" x "Speed reduction ratio digit setting"].	0: x1 1: x0.1 2: x0.01	2	
2039	Speed increasing ratio	Sets the speed increasing ratio. If the speed increasing ratio is set to the value other than 1, the rotation speed calculated by the formula [motor rotation speed x setting value] is displayed. At this time, the setting of the speed reduction ratio is disabled.	1.00 to 2.00	1.00	
450	Motor rotation direction	Sets the rotation direction of the motor output shaft when inputting the FWD input. Refer to p.38 for the rotation direction.	0: Positive direction=CCW 1: Positive direction=CW	1	C

■ Setting method of the rotation speed and torque limiting value

The setting method can be selected using the "Speed, torque limiting command selection" parameter. Refer to the table below for descriptions of the selection range.

- Digital setting: Operation panel, **MEXE02**
- Analog setting: External potentiometer (accessory), external DC voltage

● "Speed, torque limiting command selection" parameter (ID: 1820)

Operation data No.	Setting value: 0		Setting value: 1		Setting value: 2		Setting value: 3	
	Rotation speed	Torque limiting	Rotation speed	Torque limiting	Rotation speed	Torque limiting	Rotation speed	Torque limiting
0	Digital setting	Digital setting	Digital setting	Digital setting	Analog setting	Digital setting	Digital setting	Analog setting
1			Analog setting					
2 to 15			Digital setting					

- [Setting value]
- Digital setting for the rotation speed and torque limiting value in all operation data: "0"
 - Analog setting for one of the rotation speed (operation data No.1), and digital setting for other operation data: "1"
 - Analog setting for the rotation speed, and digital setting for the torque limiting value in each operation data: "2"
 - Digital setting for the rotation speed in each operation data, and analog setting for the torque limiting value: "3"

■ Calculation method of speed reduction ratio: "Speed reduction ratio" parameter (ID: 2033), "Speed reduction ratio digit setting" parameter (ID: 2038).

Set using the "Speed reduction ratio" parameter (ID: 2033) and "Speed reduction ratio digit setting" parameter (ID: 2038).

In the case of motors with the **JH** gearhead, the **JB** gearhead, and the **JV** gearhead, use the actual gear ratio about the gear ratio of gearhead.
Check the operating manual supplied with the motor for the actual gear ratio.

To display the rotation speed for the gearhead gear ratio



Rotation speed

Example) When the speed reduction ratio 15 is set

Set 150 to the "Speed reduction ratio" parameter and 1 to the "Speed reduction ratio digit setting" parameter. 15 that was calculated by the formula "150 x 0.1" was set.

At this time, the display of the rotation speed shows one-fifteenth of the motor rotation speed.

For example, when the motor rotation speed is 1300, "86.6" is shown on the display.



To display as the conveyor transfer speed

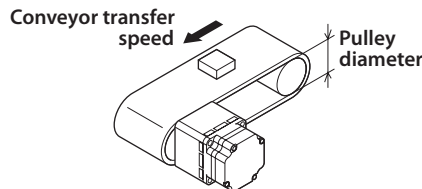

To display the conveyor transfer speed, calculate the conveyor speed reduction ratio by using the formula below and set to the "Speed reduction ratio" parameter.

$$\text{Conveyor speed reduction ratio} = \frac{1}{\text{Feed rate per motor revolution}} = \frac{\text{Gearhead gear ratio}}{\text{Pulley diameter [m]} \times \pi}$$

When the calculated conveyor speed reduction ratio is used, the conveyor transfer speed is converted as follows.

$$\text{Conveyor transfer speed [m/min]} = \frac{\text{Motor output shaft rotation speed [r/min]}}{\text{Conveyor speed reduction ratio}}$$

Example) The pulley diameter is 0.1 m and the gear ratio of the gearhead is 20

$$\text{Conveyor speed reduction ratio} = \frac{\text{Gearhead gear ratio}}{\text{Pulley diameter [m]} \times \pi} = \frac{20}{0.1 \text{ [m]} \times \pi} \cong 63.7$$

From the conversion formula, the conveyor speed reduction ratio is calculated as 63.7 in this example.

If the conveyor speed reduction ratio is 63.7 and the rotation speed of the motor is 1300 r/min, the conveyor transfer speed is converted as follows:

$$\text{Conveyor transfer speed [m/min]} = \frac{1300}{63.7} \cong 20.4$$

Accordingly, "20.4" is shown on the display.



■ Display for when setting the speed reduction ratio

The position of the decimal point displayed on the rotation speed monitor varies as shown in the table below depending on the set speed reduction ratio or conveyor speed reduction ratio.

Setting for speed reduction ratio, calculated conveyor speed reduction ratio	Displayed decimal point position
1.00 to 9.99	□ □ □ □
10.00 to 99.99	□ □ □ □ . □
100.0 to 999.9	□ □ □ . □ □
1000 or more	□ □ . □ □ □

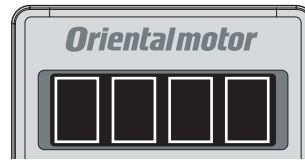

3-2 Speed, torque limiting command selection parameter

A: Effective immediately, B: Effective after stopping the operation

ID	Parameter name	Description	Setting range	Factory setting	Effective
2085	Speed upper limit	Sets the upper limit value of the speed command.	50 to 4000 [r/min]	4000	B
2086	Speed lower limit	Sets the lower limit value of the speed command.	50 to 4000 [r/min]	50	
1821	Analog operation speed command gain	Sets the speed command per 1 VDC of the input voltage by the external analog setting device.	0 to 4000 [r/min/V]	850	A
1822	Analog operation speed command offset	Sets the offset of the speed command input by the external analog setting device.	-2000 to +2000 [r/min]	0	
1823	Analog torque limiting gain	Sets the torque limiting value per 1 VDC of the input voltage by the external analog setting device.	0 to 300 [%/V]	65	
1824	Analog torque limiting offset	Sets the offset of the torque limiting input by the external analog setting device.	-150 to +150 [%]	0	
1825	Analog torque limiting maximum value	Sets the maximum value of the torque limiting by the external analog setting device.	0 to 300 [%]	300	

■ Limiting the setting range of the rotation speed

● "Speed upper limit" parameter (ID: 2085), "Speed lower limit" parameter (ID: 2086)

The setting range of the rotation speed is set to 50 to 4000 r/min at the time of shipment. This setting range can be changed to limit.

Setting range of the rotation speed

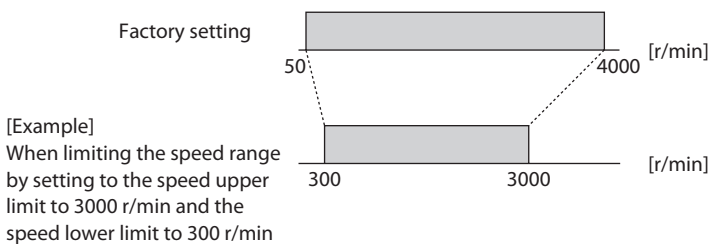

● Speed upper limit

Set the upper limit value of the rotation speed in the "Speed upper limit" parameter.

If the rotation speed exceeding the speed upper limit value is already set, the rotation speed is limited to the speed set in the "Speed upper limit" parameter.

● Speed lower limit

Set the lower limit value of the rotation speed in the "Speed lower limit" parameter.

If the rotation speed below the speed lower limit value is already set, the rotation speed is limited to the speed set in the "Speed lower limit" parameter.

If the analog setting is used for the speed setting method

Even if the "Speed lower limit" parameter is set to 50 [r/min] or more, under the condition of the analog operation speed command of less than 50 [r/min], the speed setting is acknowledged as 0 [r/min] to stop the motor.

To rotate the motor at the setting value in the "Speed lower limit" parameter without stopping, set 50 [r/min] or more in the "Analog operation speed command offset" parameter.

3-3 Alarm, Information setting parameters

A: Effective immediately, C: Effective after executing the configuration

ID	Parameter name	Description	Setting range	Factory setting	Effective
384	Overload alarm detection time	Sets the detection time of the overload alarm. 200 W or lower: at a time of about 180% load 300 W or higher: at a time of about 150% load	0.1 to 40.0 [s]	30.0	A
414	Prevention of operation at power-on alarm	Sets whether to enable or disable the "prevention of operation at power-on alarm." Refer to p.70 for alarms.	0: Disable 1: Enable	1	C
416	Driver temperature information	Sets the generation condition of the driver temperature information.	40 to 85 [°C]	85	A
418	Speed information	Sets the generation condition of the speed information.	50 to 5000 [r/min]	5000	
422	Load information	Sets the generation condition of the load information.	10 to 300 [%]	300	
425	Overvoltage information	Sets the generation condition of the overvoltage information.	280 to 440 [V]	435	
426	Undervoltage information	Sets the generation condition of the undervoltage information.	120 to 280 [V]	120	
431	Tripmeter information	Sets the generation condition of the tripmeter information.	0: Disable 1 to 999,999,999 (1=0.1 kRev)	0	
432	Odometer information	Sets the generation condition of the odometer information.	0: Disable 1 to 999,999,999 (1=0.1 kRev)	0	
438	Main power supply time information	Sets the generation condition of the main power supply time information.	0: Disable 1 to 999,999,999 [min]	0	
439	Main power supply count information	Sets the generation condition of the main power supply count information.	0: Disable 1 to 999,999,999 [times]	0	
447	INFO auto clear	Sets whether a state of generating information is automatically cleared when the cause generated the information was removed.	0: Disable 1: Enable	1	
1954	INFO action (Driver temperature information (INFO-DRVTMP))	Sets the INFO output and LED status when corresponding information is generated. Only the specified information can be output. The bit output status of each Information is not changed. The bit output can be checked using the internal I/O monitor of the MEXE02 .	0: INFO action is not applied · INFO output: OFF · LED: Unlit 1: INFO action is applied · INFO output: ON · LED: Blink	1	
1956	INFO action (Overvoltage information (INFO-OVOLT))				
1957	INFO action (Undervoltage information (INFO-UVOLT))				
1959	INFO action (Load information (INFO-LOAD))				
1960	INFO action (Speed information (INFO-SPD))				
1964	INFO action (Operation prohibited information (INFO-DRV))				
1972	INFO action (Tripmeter information (INFO-TRIP))				
1973	INFO action (Odometer information (INFO-ODO))				
1978	INFO action (Main power supply time information (INFO-PTIME))				
1979	INFO action (Main power supply count information (INFO-PCOUNT))				
1980	INFO action (Operation start limiting mode information (INFO-DSLMTD))				
1981	INFO action (I/O test mode information (INFO-IOTEST))				
1982	INFO action (Configuration request information (INFO-CFG))				
1983	INFO action (Power cycling request information (INFO-RBT))				

■ Changing the overload alarm detection time

You can change the time till the overload alarm is detected after the motor output torque exceeded the overload detection level. The time when the overload alarm is generated varies according to the load factor of the motor.

Overload alarm detection time

The time set in the "Overload alarm detection time" parameter (ID: 384) is an operating time at the following load factor.

- 200 W or lower: About 180%
- 300 W or higher: About 150%

● 200 W or lower

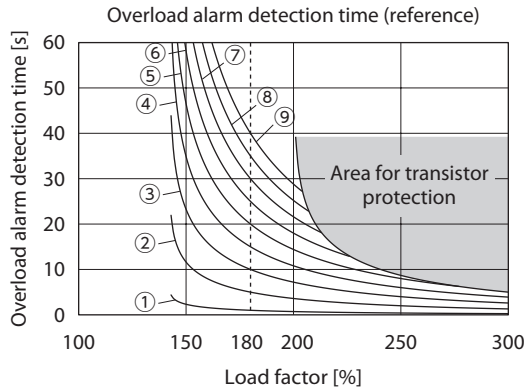

● 300 W or higher

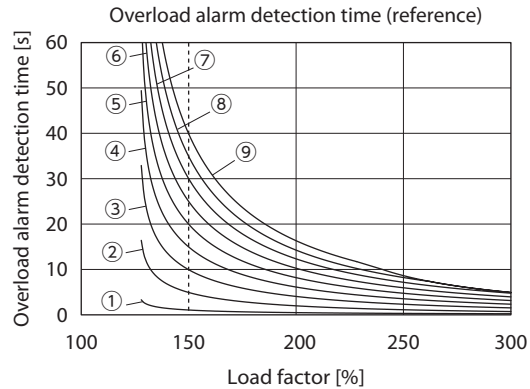

Setting value

- ① : 1 second
- ② : 5 seconds
- ③ : 10 seconds
- ④ : 15 seconds
- ⑤ : 20 seconds
- ⑥ : 25 seconds
- ⑦ : 30 seconds
- ⑧ : 35 seconds
- ⑨ : 40 seconds

■ Operating the motor by ON-OFF control of the power supply

The "Prevention of operation at power-on alarm" parameter is set to enable at the time of shipment in order to prevent the motor from rotating suddenly when the power is turned on.

Changing the following parameter can operate or stop the motor by ON-OFF control of the power supply.

Note

Execute an operation after confirming thoroughly that no risk occurs by rotation of the motor.

● Setting procedure

1. Set the "Prevention of operation at power-on alarm" parameter from "1 (Enable)" to "0 (Disable)."

2. Set a rotation speed in the operation data.

If the operation data number is not selected, the motor rotates at the rotation speed set in the operation data No.0. To use an external analog setting device, change the "Speed, torque limiting command selection" parameter.

3. Turn the operation input signal (FWD input or REV input) ON.

Input a signal indicating the motor rotation direction desired.

4. Turn off the driver power. Turn on the power again, and the motor will rotate immediately.

To stop the motor, turn off the driver power or turn the operation input signal OFF.

3-4 Operation setting parameters

B: Effective after stopping the operation, C: Effective after executing the configuration

ID	Parameter name	Description	Setting range	Factory setting	Effective
2069	Slight position-keeping function selection	Sets whether the holding force of about 50% of the rated torque is generated when the motor stops.	0: Disable 1: Enable	0	C
329	Acceleration/deceleration unit selection	Sets the setting unit for the acceleration time and deceleration time for when setting the rotation speed to the digital setting.	0: [s / 3000 r/min] 1: [s]	0	B
330	Impact softening filter	This is a function to soften an impact at starting and stopping against the set acceleration time and deceleration time.	0: No filter 1: Filter 1 2: Filter 2	0	

■ Holding a load at motor standstill

● "Slight position-keeping function selection" parameter (ID: 2069)

If the "Slight position-keeping function selection" parameter is set to 1 (enable), the holding torque of about 50% of the rated torque is generated when the motor stops (slight position-keeping torque). The factory setting is 0 (disable).

- If the angle of the motor output shaft is changed about 15°, a holding force is generated. The position of a load exceeding 50% * of the rated torque cannot be kept.
- When the power supply to the driver is turned off, the holding force is lost. This function cannot be used for keeping the load position in the event of a power outage.

* If the torque limiting value is set to 50% or less, the holding force will not generate beyond the torque limiting value.

If the slight position-keeping function is set to enable, the time until the motor stops will be longer than the disabled setting according to the setting or load conditions. In addition, the motor output shaft may vibrate when the motor stops.

■ Setting the acceleration/deceleration time

● "Acceleration/deceleration unit selection" parameter (ID: 329)

When the setting is "0"

The acceleration time is set as the time needed for the motor to reach the rated rotation speed (3000 r/min) from the standstill state.

The deceleration time is set as the time needed for the motor to stop from the rated rotation speed (3000 r/min).

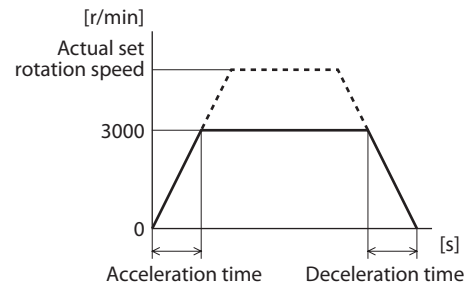

When the setting is "1"

When the rotation speed is set by the digital setting, you can set by the time in the right figure with reference to the set rotation speed.

However, if the "Operation input mode selection" parameter is set to 3 or 5, the setting of the "Acceleration/deceleration unit selection" parameter is not applied. Refer to p.58 for the "Operation input mode selection" parameter.

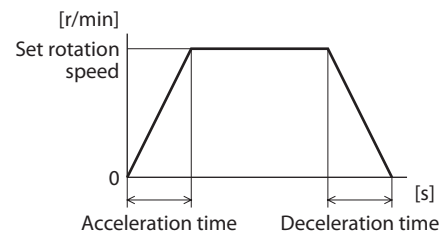

■ Softening an impact at starting and stopping

● "Impact softening filter" parameter (ID: 330)

This is a function to accelerate slowly and decelerate slowly so as not to move the position of the transported load when starting and stopping.

It can soften an impact for when starting, stopping, and changing the speed against the set acceleration time and deceleration time.

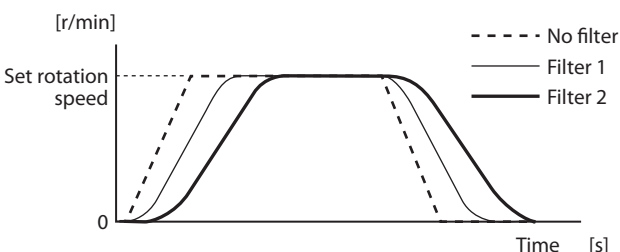

3-5 I/O action parameters

A: Effective immediately, C: Effective after executing the configuration

ID	Parameter name	Description	Setting range	Factory setting	Effective
1819	Operation input mode selection	Selects whether the operation input signal will be used in the 2-wire input mode or the 3-wire input mode. Refer to p.26 for the 2-wire input mode or 3-wire input mode. Also, using this parameter, operation patterns of operation input signals can be changed as shown in the figure below.	0: 2-wire input mode 1 1: 3-wire input mode 1 2: 2-wire input mode 2 3: 2-wire input mode 3 4: 3-wire input mode 2 5: 3-wire input mode 3	0	C
1817	VA detection width	Sets the output width of the VA output.	1 to 400 [r/min]	200	A

■ "Operation input mode selection" parameter (ID: 1819)

● 2-wire input mode

The motor operation patterns for when the FWD input and REV input are turned ON simultaneously are varied.

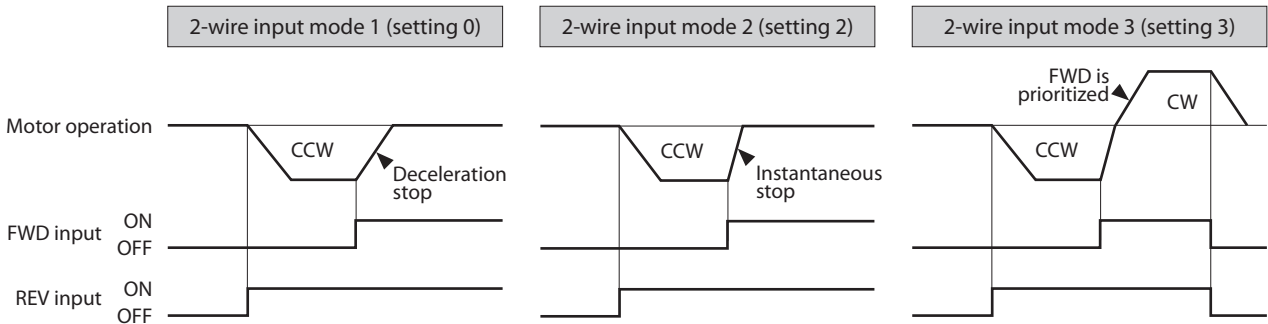

● 3-wire input mode

The motor operation patterns for when the CW/CCW input is switched are varied.

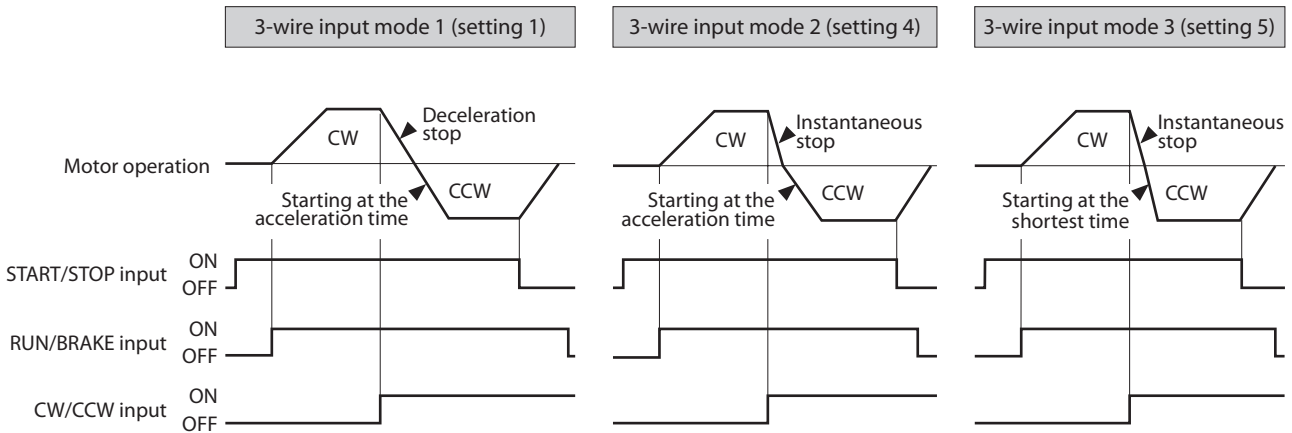

■ "VA detection width" parameter (ID: 1817)

The VA output is output when the motor reaches the plus or minus range of the "VA detection width" against the set rotation speed. The VA detection width can be set in a range of 1 to 400 r/min against the set rotation speed. (Factory setting: 200 r/min)

Example: When the motor speed changes from the setting speed 1 to the setting speed 2

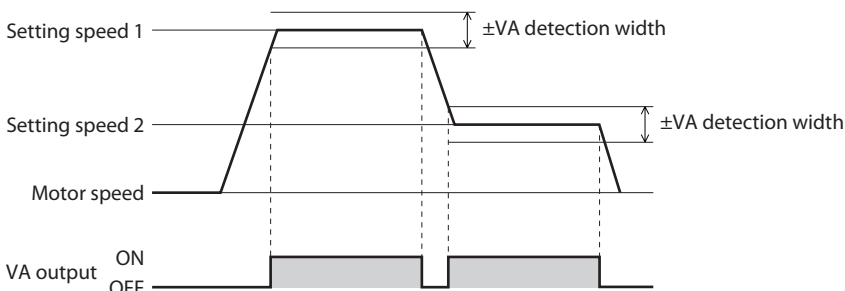

3-6 I/O function selection parameters

C: Effective after executing the configuration

ID	Parameter name	Description	Setting range	Factory setting	Effective
2112	IN0 input function selection	Assigns the input signals to the input terminal IN0 to IN6.	Refer to the "Input function selection" parameters in the table below.	58	C
2113	IN1 input function selection			59	
2114	IN2 input function selection			72	
2115	IN3 input function selection			64	
2116	IN4 input function selection			65	
2117	IN5 input function selection			8	
2118	IN6 input function selection			73	
2128	IN0 logic level setting			Sets the logic level setting of input signals.	
2129	IN1 logic level setting				
2130	IN2 logic level setting				
2131	IN3 logic level setting				
2132	IN4 logic level setting				
2133	IN5 logic level setting				
2134	IN6 logic level setting				
2144	OUT0 output function selection	Assigns the output signals to the output terminals OUT0 and OUT1.	Refer to the "Output function selection" parameters in the table below.	147	
2145	OUT1 output function selection			130	
2160	OUT0 logic level setting	Sets the logic level setting of output signals.	0: Non invert 1: Invert	0	
2161	OUT1 logic level setting				

■ Setting range of the function selection parameters

● Input function selection parameters *1

0: Not used	64: M0
8: ALARM-RESET	65: M1
14: INFO-CLR	66: M2
16: HMI	67: M3
22: TL	72: STOP-MODE (CW/CCW)
25: EXT-ERROR	73: MB-FREE*2
58: FWD (START/STOP)	74: H-FREE
59: REV (RUN/BRAKE)	

*1 If the 3-wire input mode is selected with the "Operation input mode selection" parameter, the signal in the parentheses () will be applied.

*2 Not used

● Output function selection parameters

0: Not used	140: TLC
130: ALARM-OUT	141: VA
134: MOVE	147: SPEED-OUT
135: INFO	148: DIR

3-7 I/O function parameters

A: Effective immediately, D: Effective after turning the power ON again

ID	Parameter name	Description	Setting range	Factory setting	Effective
488	Operation panel editing	Editing on the operation panel can be disabled. Switching to the local control operation cannot be performed if it is disabled.	0: Disable 1: Enable	1	A
489	Operation panel initial view	Sets the initial screen to display on the operation panel when the driver power is turned on.	0: Rotation speed [r/min] 1: Load factor [%] 2: Operation data number	0	
498	USB-ID enable	Sets whether to enable or disable the setting of the USB-ID. When it is set to "Disable," the USB-ID is automatically set to a random number.	0: Disable 1: Enable	1	D
499	USB-ID	Sets the USB-ID (serial number). The COM port at power-on can be fixed.	0 to 999,999,999	0	
2555	USB-PID	Sets the ID to be displayed in the COM port.	0 to 31	0	

Setting and monitor by the MEXE02

This chapter explains the setting and monitor using the **MEXE02**.
Refer to the operating manual of the **MEXE02** for the basic setting and saving data of the **MEXE02**.

1. Setting the data

1. Start the MEXE02.

Click the [New] icon in the toolbar.
Select "**BLE2 [AC]**" under "**BLE2**."

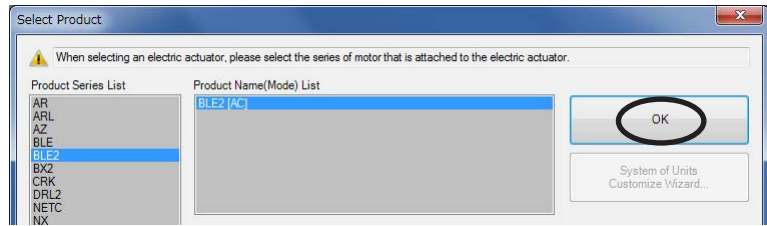

2. The data edit window opens.

3. Click [Operation data] in TreeView.

The operation data edit window appears.

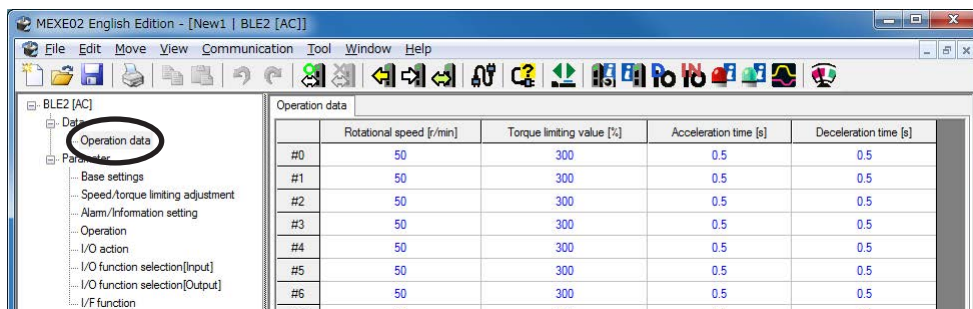

Refer to the operating manual of the **MEXE02** for how to edit the data and others.

4. Write the data to the driver after editing.

Click "Data writing" in the toolbar.



2. Setting the parameters

1. The data edit window opens.

2. Click the parameter to be edited in TreeView.

The parameter edit window appears.

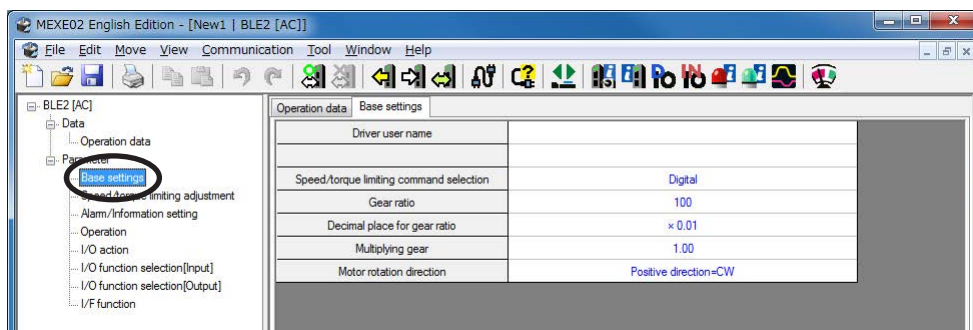

Refer to the operating manual of the **MEXE02** for how to edit the data and others.

3. Write the data to the driver after editing.

Click "Data writing" in the toolbar.



3. Monitor

■ Unit information monitor

The device information of the **BLE2** Series can be monitored.

1. Start "Unit information monitor" using either of the following methods.

Starting from the toolbar: Click the "Unit information monitor" icon
Starting from the shortcut button: Click "Unit information monitor"

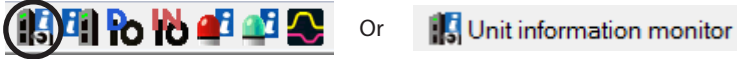

The window of the unit information monitor appears.

2. Click "Unit information monitor."

The unit information monitor starts.

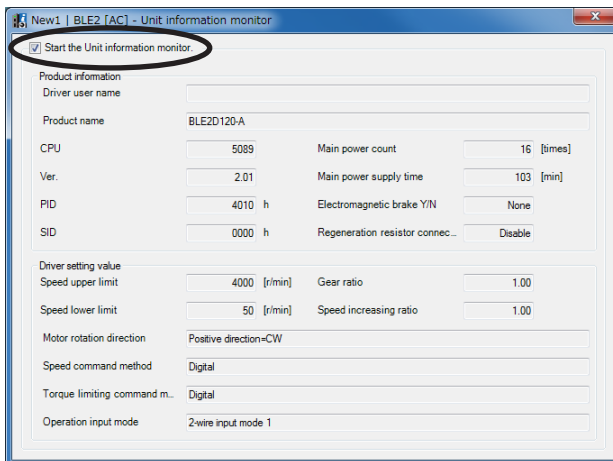

3. To exit the unit information monitor, unselect "Unit information monitor."

■ Status monitor

The operating status of the **BLE2** Series can be monitored.

1. Start the "Status monitor" using either of the following methods.

Starting from the toolbar: Click the "Status monitor" icon
Starting from the shortcut button: Click "Status monitor"



The window of the status monitor appears.

2. Click "Start Status monitor."

Status monitor starts.

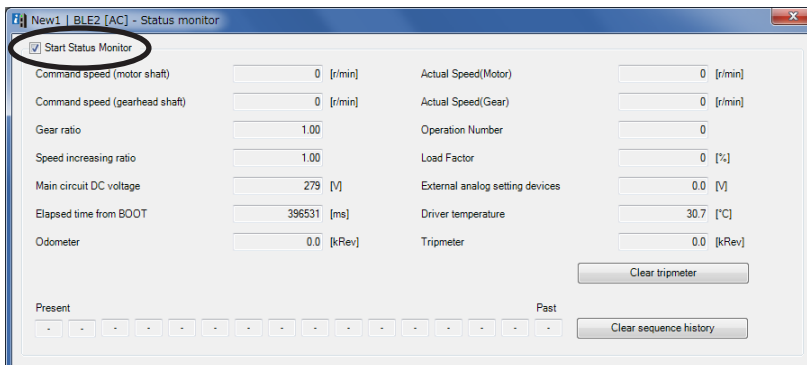

3. To exit the status monitor, unselect "Start Status monitor."

D-I/O monitor

The ON-OFF status of the I/O signals of the **BLE2** Series and the setting value of the external analog setting device (the display varies depending on the setting of the "Speed, torque limiting command" parameter) can be monitored.

D-I/O represents direct I/O.

1. Start the "D-I/O monitor" using either of the following methods.

Starting from the toolbar: Click the "D-I/O monitor" icon

Starting from the shortcut button: Click "D-I/O monitor"



The window of the D-I/O monitor appears.

2. Click "Start D-I/O Monitor."

The D-I/O monitor starts.

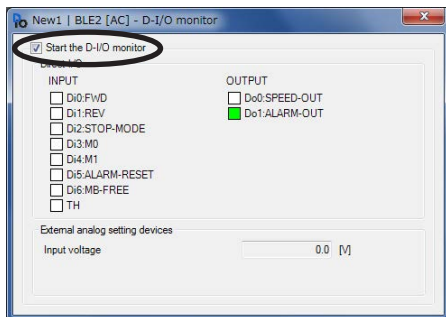

The ON-OFF status of the I/O signals is shown as follows.

Display	Direct I/O signal name
ON (green)	Conduction state
OFF (white)	Nonconduction state

3. To exit the D-I/O monitor, unselect "Start D-I/O Monitor."

I/O test

The I/O signals of D-I/O can be tested. Forcible output of output signals in addition to Monitor of input signals and external DC voltage can be executed.

This function is convenient if you want to check the wiring condition with the programmable controller.

Refer to the operating manual of the **MEXE02** for the operating method and others.

Note

- Output signals can forcibly be turned ON or OFF with I/O test. Therefore, other devices, which were controlled using the output signals of the **BLE2** Series, may operate. Before operation, check the condition of the surrounding area to ensure safety.
- Teaching, remote operation and I/O test cannot be executed at the same time.
- If I/O test is started while the slight position-keeping function is enabled, the holding force of the motor is lost. When I/O test is ended, the holding force is generated.

Internal I/O monitor

All of I/O signals of the **BLE2** Series can be monitored. Signals that are not assigned to direct I/O can be checked.

1. Start the "Internal I/O monitor" using either of the following methods.

Starting from the toolbar: Click the "Internal I/O monitor" icon

Starting from the shortcut button: Click "Internal I/O monitor"



The window of the internal I/O monitor appears.

2. Click "Start Internal I/O monitor."

The internal I/O monitor starts.

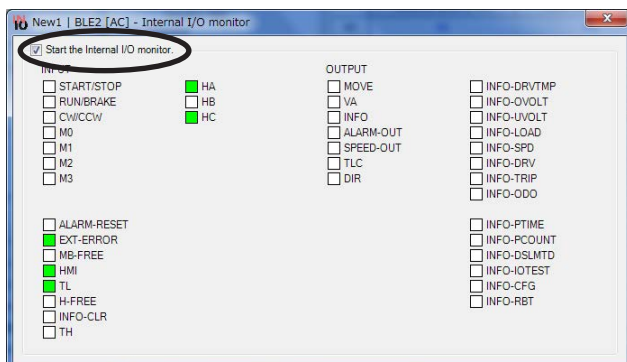

The ON-OFF status of the I/O signals is shown as follows.

Display	Internal signal status
ON (green)	Active state
OFF (white)	Non-active state

3. To exit the internal I/O monitor, unselect "Start Internal I/O Monitor."

Alarm monitor

The alarm information of the BLE2 Series can be monitored.

1. Start the "Alarm monitor" using either of the following methods.

Starting from the toolbar: Click the "Alarm monitor" icon

Starting from the shortcut button: Click "Alarm monitor"



The window of the alarm monitor appears.

2. Click "Start Alarm monitor."

The alarm monitor starts.

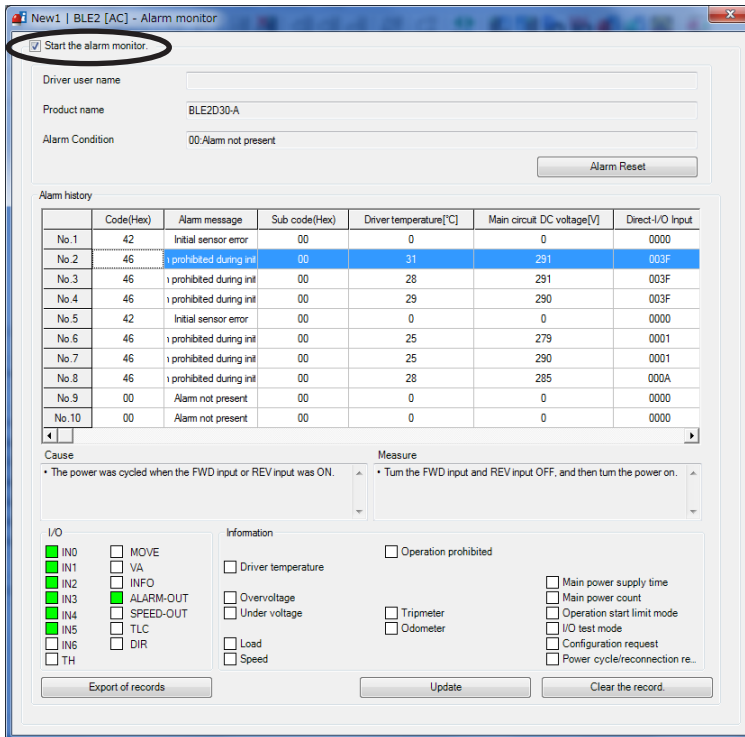

Items that can be checked in the alarm records

Item	Connection
Code	This is an alarm code.
Alarm message	This is the description of the alarm.
Sub code	This is our code for checking.
Driver temperature	This is the driver temperature for when an alarm is generated.
Main circuit DC voltage	This is the internal voltage of the driver for when an alarm was generated.
Physical I/O input	Shows the status of the IN0 to IN6 for when an alarm was generated.
Internal I/O output	Shows the status of the internal I/O for when an alarm was generated.
Operation data number	Shows the data number operated for when an alarm was generated.
Command speed	Shows the rotation speed command operated for when an alarm was generated.
Detection speed	Shows the detected speed for when an alarm was generated.
Load factor	Shows the motor load factor for when an alarm was generated.
Elapsed time from BOOT	This is the elapsed time from the input of the main power supply to the generation of the alarm.
Elapsed time from starting operation	This is the elapsed time from the start of the operation to the generation of the alarm.
Main power supply time	This is the elapsed time from the input of the main power supply of the driver to the generation of the alarm.

When the sensor error at power-on and the EEPROM error shortly after power-on are generated, "0" is shown in all fields. (Excluding the code, alarm message, and main power supply time)

3. To exit the alarm monitor, unselect "Start Alarm monitor."

■ Information monitor

Information contents of the **BLE2** Series can be monitored.

1. Start the "Information monitor" using either of the following methods.

Starting from the toolbar: Click the "Information monitor" icon
Starting from the shortcut button: Click "Information monitor"



The window of the information monitor appears.

2. Click "Start Information monitor."

The information monitor starts.

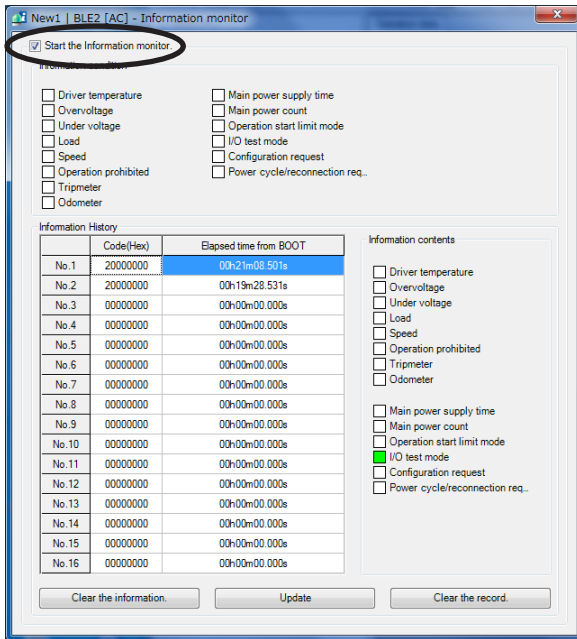

3. To exit the information monitor, unselect "Start Information monitor."

■ Waveform monitor

The motor rotation speed or the status of I/O signals can be checked in a waveform format.

1. Start the "Waveform monitor" using either of the following methods.

Starting from the toolbar: Click the "Waveform monitor" icon
Starting from the shortcut button: Click "Waveform monitor"



The window of the waveform monitor appears.

2. Click "Start Waveform monitor."

The buttons in the window are enabled, allowing you to prepare for measurement of gain tuning.

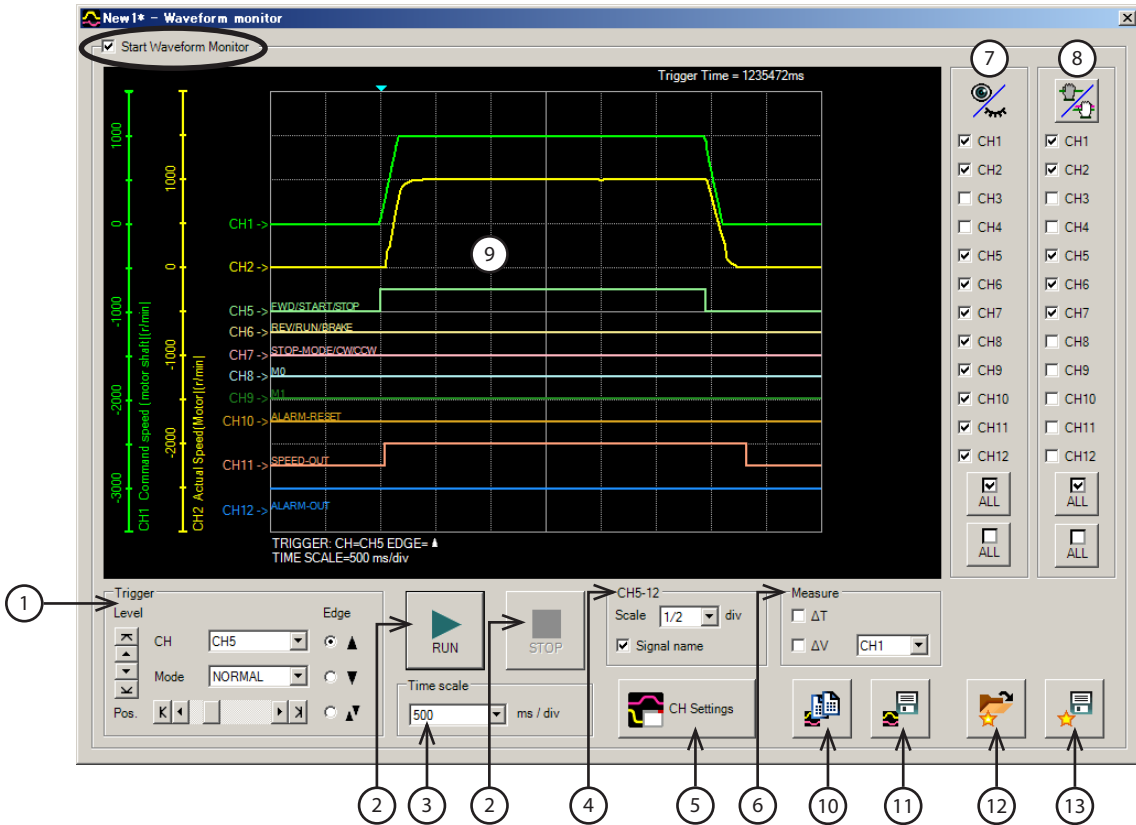

1	Level, CH, Mode, Edge (detection condition), and Pos (trigger position) can be set. For "CH," only those CHs displayed on ⑨ can be used.
2	Run: This button is used to start measurement. Stop: This button is used to stop measurement.
3	The measurement time range (width) can be set.
4	The display method for CH5 to CH12 can be set. Scale: The display size can be selected from 1/1 (100%), 1/2 (50%), or 1/4 (25%). Signal name: The signal name can be shown or hidden.
5	The CH setting window can be shown.
6	Measure for measurement can be shown or hidden. Also, the CH to be measured can be selected.
7	Each CH can be shown or hidden.
8	When the display position of the waveform drawn on the window is moved, the CH items selected here can be moved all together.
9	Measurement results are drawn in this area.
10	The presently displayed waveform can be copied to the clipboard.
11	The presently displayed waveform can be saved to an external file.
12	The setting for measurement can be loaded from "Favorites data."
13	The setting for measurement can be saved as "Favorites data."

3. Click the "CH Settings."

The CH setting window is shown. Set the measurement condition for each CH.

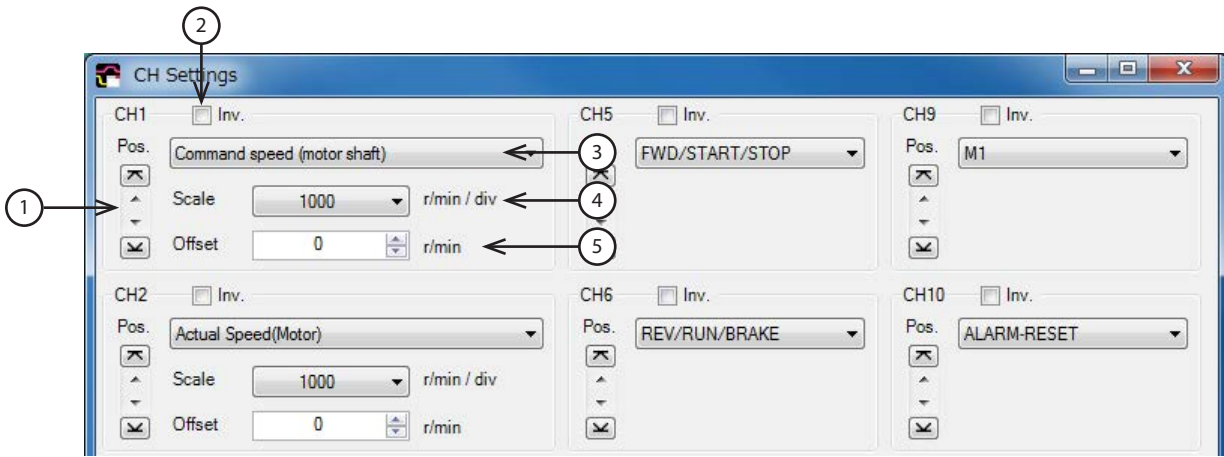

1	The display position of a waveform can be moved up or down.
2	The display of measured signal can be inverted.
3	The signal to be measured can be selected.
4	This is used to select a display scale for signals (CH1 to CH4 only). Using this in combination with 5 can zoom in on signals.
5	The set offset value is added to the signal display (CH1 to CH4 only). Using this in combination with 4 can zoom in on signals.

4. Click "RUN."

Waveform measurement starts.

5. During measurement, click "Stop" to exit the waveform measurement.

If "SINGLE" is selected for Mode in Trigger, measurement automatically ends when the waveform drawing ends.

6. To exit the waveform monitor, unselect "Start Waveform monitor."

4. Teaching, remote operation

A motor can be operated using the **MEXE02**. The motor operation can be checked before connecting to a programmable controller.

Also, the teaching function of the operation data can be performed.

The ALARM LED on the driver blinks in orange when teaching, remote operation is started.



- Teaching, remote operation and I/O test cannot be executed at the same time.
- During teaching, remote operation, the torque limiting value set in the teaching data is prioritized.

1. Start the "Teaching, remote operation" using either of the following methods.

Starting from the toolbar: Click the "Teaching, remote operation" icon

Starting from the shortcut button: Click "Teaching, remote operation"



The window of the teaching, remote operation appears.

2. Click "Start Teaching, remote operation."

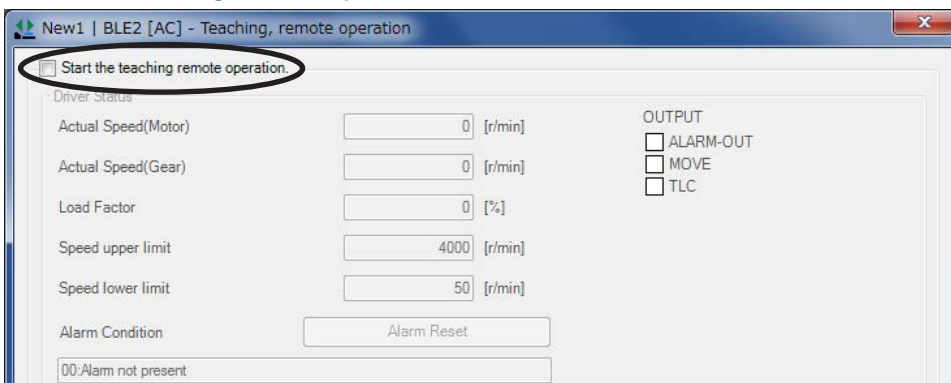

3. Click "Yes."

Teaching, remote operation is enabled.

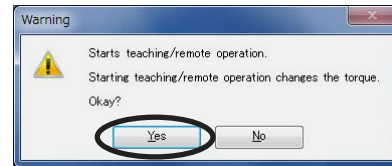

Teaching, remote operation requires synchronization of the data under editing and the data of an applicable product. When the data is not synchronized, the following window appears. Select a synchronization method and click "OK."

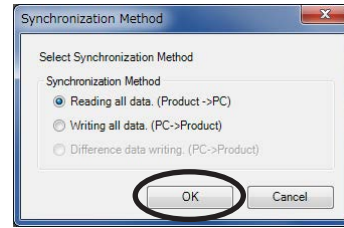

Note When the above window appears, all the communications in progress will be OFF. All the other monitors in progress in other windows are also stopped. Resume monitor after synchronization is completed.

4. Execute teaching, remote operation using buttons in the window.

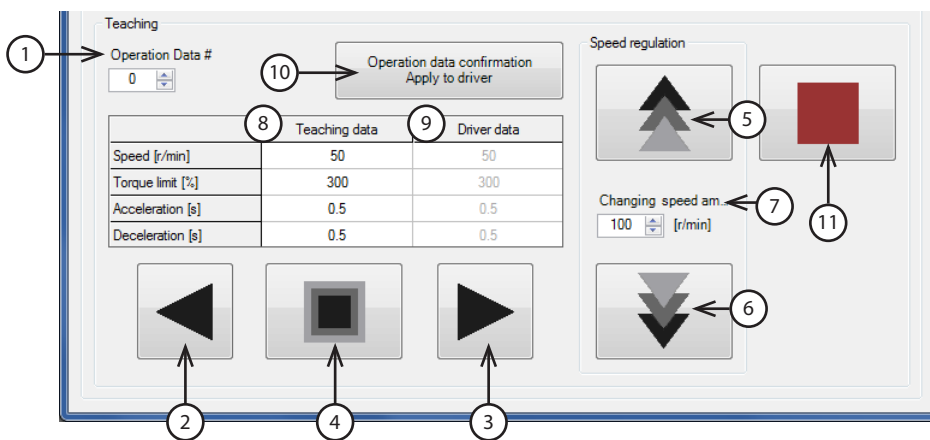

1	The operation data number that the teaching function is performed can be selected.
2	The motor rotates in the reverse direction.
3	The motor rotates in the forward direction.
4	The motor decelerates to a stop.
5	This button is used to accelerate the motor rotation speed.
6	This button is used to decelerate the motor rotation speed.
7	This is used to set the changed value of the rotation speed for when pressing 5 or 6 once.
8	This is the operation data to be changed by the teaching function. The value can be changed directly.
9	This is the operation data presently written to the driver.
10	This button is used to write the teaching data to the operation data number.
11	This button is used to stop the rotating motor instantaneously by pressing 2 or 3.

5. To exit the teaching, remote operation, unselect "Start Teaching, remote operation."

If "Start Teaching, remote operation" is unselected while the motor is rotating, the following window appears. Clicking "Yes" causes the motor to stop instantaneously.

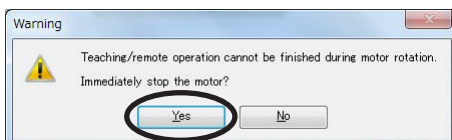

Note If the communication is disconnected while the motor is rotating, the motor decelerates to a stop.

Maintenance and inspection

1. Inspection

It is recommended that periodic inspections would be conducted for the items listed below after each operation of the motor. If an abnormal condition is noted, discontinue any use and contact your nearest Oriental Motor sales office.

Note

- Do not conduct the insulation resistance measurement or dielectric strength test with the motor and driver connected. Doing so may cause damage to the product.
- The driver uses semiconductor elements, so be extremely careful when handling them. Static electricity may damage the driver.

■ Inspection item

- Check if any of the mounting screws of the motor and gearhead are loose.
- Check if the motor or gearhead generates unusual noises from inside.
- Check if the output shaft of the motor and gearhead and a load shaft are out of alignment.
- Check if a damage or stress is applied on the cable or the connection part between the cable and driver is loose.
- Check if the openings in the driver causes clogging.
- Check if the mounting screws or the main power supply connection of the driver are loose.
- Check if the driver generates unusual smells or has foreign objects inside.

2. Warranty

Check on the Oriental Motor Website for the product warranty.

3. Disposal

Dispose the product correctly in accordance with laws and regulations, or instructions of local governments.

Troubleshooting

During motor operation, the motor or driver may fail to function properly due to an improper speed setting or wiring. When the motor cannot be operated correctly, refer to the contents provided in this chapter and take appropriate action. If the problem persists, contact your nearest Oriental Motor sales office.



- Check the alarm message when the alarm generates.
- I/O signals can be monitored with the monitor mode. Use it to check the wiring condition of the I/O signals.

<p>The motor does not operate.</p>	<ul style="list-style-type: none"> ● The power supply is not connected correctly or it is improper connection. <ul style="list-style-type: none"> ▷ Check the connection of the power supply. ● An operation using external signals is being tried while the local control operation is performed. <ul style="list-style-type: none"> ▷ Press key to set the remote control operation. ● key is pressed when the local control operation is not set. <ul style="list-style-type: none"> ▷ Press key to set the local control operation before pressing the key. ● Both the FWD input and REV input are being OFF. Both the FWD input and REV input are being ON. <ul style="list-style-type: none"> ▷ Turn either the FWD input or REV input ON. ● An alarm is present. <ul style="list-style-type: none"> ▷ A protective function is triggered and an alarm is being generated. Refer to p.70 and reset the alarm after removing the cause of the alarm.
<p>The rotation speed is not displayed.</p>	<ul style="list-style-type: none"> ● The "Panel initial view" parameter is not set to the rotation speed. <ul style="list-style-type: none"> ▷ Set the "Panel initial view" parameter to the rotation speed. ● The "Speed reduction ratio" and "Speed increasing ratio" parameters are being set. <ul style="list-style-type: none"> ▷ Check the "Speed reduction ratio" and "Speed increasing ratio" parameters.
<p> is displayed and the setting is unable to do.</p>	<ul style="list-style-type: none"> ● The analog setting is applied to the rotation speed, and the speed teaching function is being executed. <ul style="list-style-type: none"> ▷ When the speed teaching function is performed, set to the digital setting. ● The ALARM-RESET is being executed using the operation panel in a condition where the FWD input and/or REV input are not turned OFF while an alarm is generated. <ul style="list-style-type: none"> ▷ Turn both the FWD input and REV input OFF before executing the ALARM-RESET input. ● Rewriting the data on the operation panel or setting to the local control operation is tried while the communication is performed via the MEXE02. <ul style="list-style-type: none"> ▷ During communication, do not change the data on the operation panel. Also, do not set to the local control operation.
<p>ALARM LED (orange) blinks.</p>	<ul style="list-style-type: none"> ● Information is present. <ul style="list-style-type: none"> ▷ Information is present by any cause. Refer to p.72, and check the reset method of the cause generated.
<p>The motor rotates in the opposite direction against the specified direction.</p>	<ul style="list-style-type: none"> ● The FWD input and REV input are connected wrongly or otherwise not connected correctly. <ul style="list-style-type: none"> ▷ Check the connection of the FWD input and REV input. ● The gear ratio that the gearhead output shaft rotates in the opposite direction against the motor rotation direction is used. <ul style="list-style-type: none"> ▷ Check the operating manual supplied with the motor for the rotation direction of the gearhead output shaft. ● The "Motor rotation direction" parameter is set to 0 (positive side = CCW). <ul style="list-style-type: none"> ▷ Change the setting for the "Motor rotation direction" parameter to 1 (positive direction = CW).
<p>The setting cannot be performed using the setting dial.</p>	<ul style="list-style-type: none"> ● The edit lock function is enabled or the "Operation panel editing" parameter is set to disable. <ul style="list-style-type: none"> ▷ Release the edit lock function or enable the setting of the "Operation panel editing" parameter.
<p>The rotation speed cannot be increased.</p>	<ul style="list-style-type: none"> ● The speed upper limit is set. <ul style="list-style-type: none"> ▷ Increase the speed upper limit.
<p>The rotation speed cannot be decreased.</p>	<ul style="list-style-type: none"> ● The speed lower limit is set. <ul style="list-style-type: none"> ▷ Decrease the speed lower limit.
<p>The motor movement is not stable. Motor vibration is too large.</p>	<ul style="list-style-type: none"> ● The motor and gearhead output shaft is misaligned with a load shaft. <ul style="list-style-type: none"> ▷ Check the coupling condition of the motor and gearhead output shaft and the load shaft. ● The product is affected by electrical noise. <ul style="list-style-type: none"> ▷ Check the operation using the motor, driver, and a minimum of external devices required to operate. If an effect of noise has been confirmed, implement the following countermeasures: [Keep away from the noise sources.] [Review the wiring.] [Change the signal cable to a shielded cable.] [Install ferrite cores.]

Alarms

This driver has an alarm function to protect from temperature rise, poor connection, error in operation, and others. If an alarm is generated, the ALARM-OUT output is turned OFF, and the motor stops. At the same time, the alarm code is displayed on the operation panel, and the ALARM LED blinks.

1. Alarm reset

Before resetting an alarm by one of the following methods, be sure to remove the cause of the alarm and ensure safety.

- Turn the ALARM-RESET input ON. (The alarm will be reset at the ON edge of the input.)
- Execute an alarm reset using the operation panel.
- Execute an alarm reset using the **MEXE02**.
- Cycle the power.



- Some alarms cannot be reset other than cycling the power. Check with "3. Alarm lists."
- Continuing the operation without removing the cause of the alarm may cause damage to equipment.

When an alarm is reset by the ALARM-RESET input

To reset the alarm, turn the FWD input and REV input OFF, and remove the cause of the alarm before turning the ALARM-RESET input ON. If either the FWD input or Rev input is being ON, the ALARM-RESET input is disabled.

When the alarm cannot be reset by the ALARM-RESET input, once turn off the driver power, and turn on the power again after the CHARGE LED is turned off.

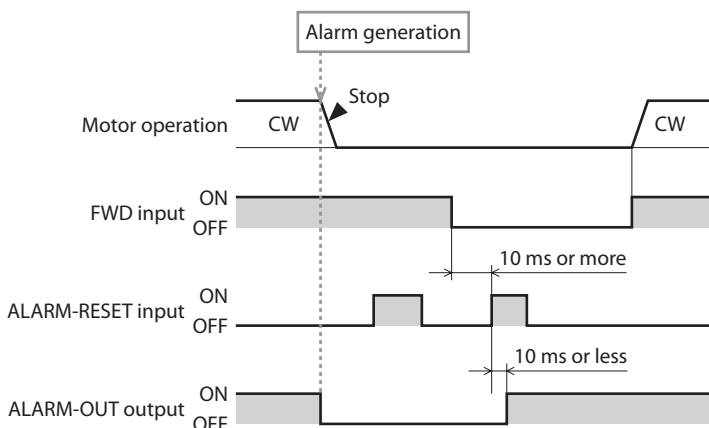











2. Alarm records

Up to 10 generated alarms are saved in the non-volatile memory in order of the latest to oldest. Alarm records are not cleared even if the power is shut off. The alarm records can be read and cleared when one of the following items is performed.

- Read and clear the alarm records by the monitor mode of the operation panel.
- Read and clear the alarm records by the **MEXE02**.

3. Alarm lists

Alarm	Cause	Remedial action	Reset by the ALARM-RESET
 Overcurrent	<ul style="list-style-type: none"> • Excessive current has flown through the driver due to ground fault, etc. • A different combination in output powers for the motor and the driver was used. 	<ul style="list-style-type: none"> • Check whether the wiring between the driver and motor is damaged. • Match the output powers for the motor and the driver. 	Not possible
 Main circuit overheat	<ul style="list-style-type: none"> • The temperature inside the driver exceeded the detection temperature of the alarm. 	<ul style="list-style-type: none"> • Review the ambient temperature. • Review the ventilation condition in the enclosure. 	Possible
 Overvoltage	<ul style="list-style-type: none"> • The power supply voltage exceeded approximately 120% of the rated voltage. • A large inertial load was stopped abruptly. 	<ul style="list-style-type: none"> • Check the power supply voltage. • If this alarm is generated during operation, decrease the load or increase the acceleration/deceleration time. 	Possible

Alarm	Cause	Remedial action	Reset by the ALARM-RESET
 Undervoltage	<ul style="list-style-type: none"> The power supply voltage dropped below approximately 60% of the rated voltage. 	<ul style="list-style-type: none"> Check the power supply voltage. Check the wiring of the power supply cable. 	Possible
 Sensor error	<ul style="list-style-type: none"> The sensor line of the connection cable was disconnected. Or the connection cable was come off. 	<ul style="list-style-type: none"> Check the wiring between the driver and motor. 	Possible
 Main circuit output error *1	<ul style="list-style-type: none"> The power lines of the connection cable were all disconnected. Or the connection cable was come off. A different combination in output powers for the motor and the driver was used. 	<ul style="list-style-type: none"> Check the wiring between the driver and motor. Match the output powers for the motor and the driver. 	Possible
 Overload	<ul style="list-style-type: none"> A load exceeding the rated torque was applied to the motor for the time set in the "Overload alarm detection time" parameter. The time when the overload alarm is generated varies according to the load torque. Refer to p.56 for details. 	<ul style="list-style-type: none"> Decrease the load. Review the operating condition such as the acceleration/deceleration time. If this alarm is generated in low temperature environment, perform a trial operation in a light load state. 	Possible
 Overspeed	<ul style="list-style-type: none"> The motor detection speed was exceeded 5200 [r/min]. A different combination in output powers for the motor and the driver was used. 	<ul style="list-style-type: none"> Decrease the load. Review the operating condition such as the acceleration/deceleration time. Match the output powers for the motor and the driver. 	Possible
 EEPROM error	<ul style="list-style-type: none"> The stored data of the driver was damaged. 	<ul style="list-style-type: none"> Initialize the parameter. 	Not possible
 Sensor error at power-on	<ul style="list-style-type: none"> The sensor line of the connection cable was disconnected before the power is supplied. Or the connection cable was come off. 	<ul style="list-style-type: none"> Check the wiring between the driver and motor. 	Possible
 Prevention of operation at power-on*2	<ul style="list-style-type: none"> The power supply was turned on again when the operation input signal was being ON. 	<ul style="list-style-type: none"> Before supplying power to the driver, turn the operation input signal OFF. 	Possible
 Regeneration resistor overheat	<ul style="list-style-type: none"> The regeneration resistor is not connected properly. The regeneration resistor was overheated extraordinarily. 	<ul style="list-style-type: none"> Check the connection for the thermostat output and the TH input of the regeneration resistor. The power consumption of the regeneration resistor exceeds the allowable level. Review the load condition and operating condition. 	Possible
 External stop	<ul style="list-style-type: none"> The EXT-ERROR input was turned OFF. 	<ul style="list-style-type: none"> Check the EXT-ERROR input. 	Possible

*1 This alarm does not generate when the torque limit is set to 60% or less.

*2 This alarm can be disabled with the "Prevention of operation at power-on alarm" parameter.

About regeneration resistor overheat alarm

The regeneration resistor overheat alarm "" may be generated even when the regeneration resistor is not connected. Once the main power supply is turned on in a state where the pin No.10 and No.11 (TH input) of the CN5 are short-circuited, the driver recognizes that the regeneration resistor is being connected.

After that, turning on the power supply again in a state where anything is not connected to the pin No.10 and No.11 of the CN5 causes the regeneration resistor overheat alarm to generate.

To reset the alarm, execute initialization of parameters without connecting anything to the pin No.10 and No.11 of the CN5. Turning on the main power supply again will reset the alarm.

Information

The driver has information function to be output before an alarm is generated. This function can be utilized for periodic maintenance of equipment by setting a suitable value in the parameter of each information.

Information in details can be checked using the **MEXE02** or the monitor mode of the operation panel.

● INFO output

If information is generated, the INFO output is turned ON.

● LED indicator

The ALARM LED blinks in orange when information is generated.

● Information bit output

If information is generated, a bit output (INFO-** output) of the corresponding information is turned ON. The bit output can be checked using the internal I/O monitor or waveform monitor of the **MEXE02**.

● Motor operation

The motor continues to operate during information unlike in the case of an alarm.

● Parameter





A generation condition for some information can be adjusted by parameter setting. Each information has a corresponding "INFO action" parameter. If the parameter is set to "INFO action is not applied," only the bit output of information is turned ON.

1. Information records

Up to 16 generated information are saved in the RAM in order of the latest to oldest. Information records are cleared if the power supply is turned off. The records can be checked and cleared by the following methods.

- **MEXE02**: Information records can be checked and cleared with the information monitor.
- Operation panel: Information records can be checked and cleared with the monitor mode.

2. Information lists

Information	Information bit output signal	Cause	Condition to reset and clear
 Driver temperature	INFO-DRVTMP	<ul style="list-style-type: none"> ● The internal temperature of the driver exceeded the setting value of the "Driver temperature information" parameter. 	<ul style="list-style-type: none"> ● The internal temperature of the driver dropped below the setting value of the "Driver temperature information" parameter.
 Overvoltage	INFO-OVOLT	The main circuit DC voltage inside the driver exceeded the setting value of the "Overvoltage information" parameter due to the following causes. <ul style="list-style-type: none"> ● A large inertial load was stopped abruptly. ● A power supply voltage exceeding the specification was applied. 	The main circuit DC voltage inside the driver dropped below the setting value of the "Overvoltage information" parameter due to the following remedial actions. <ul style="list-style-type: none"> ● Set the deceleration time longer. ● Apply the power supply voltage within the specification.
 Undervoltage	INFO-UVOLT	The main circuit DC voltage inside the driver dropped below the setting value of the "Undervoltage information" parameter due to the following causes. <ul style="list-style-type: none"> ● A power supply voltage lower than the specification was applied. 	The main circuit DC voltage inside the driver exceeded the setting value of the "Undervoltage information" parameter due to the following remedial actions. <ul style="list-style-type: none"> ● Apply the power supply voltage within the specification.
 Load	INFO-LOAD	<ul style="list-style-type: none"> ● The load torque of the motor changed, and the load exceeding the setting value of the "Load information" parameter. 	<ul style="list-style-type: none"> ● The load torque of the motor changed, and the load dropped below the setting value of the "Load information" parameter.
 Speed	INFO-SPD	<ul style="list-style-type: none"> ● The detection speed of the motor exceeded the setting value of the "Speed information" parameter. 	<ul style="list-style-type: none"> ● The detection speed of the motor dropped below the setting value of the "Speed information" parameter.

Information	Information bit output signal	Cause	Condition to reset and clear
Operation prohibited	INFO-DRV	<ul style="list-style-type: none"> ● The FWD input or the REV input is being ON when the operation mode was switched from the test mode to other mode. ● The FWD input or the REV input is being ON when I/O test of the MEXE02 or teaching, remote operation was complete. ● The motor is in a state of rotating immediately when the assignment of input terminals or the logic level setting of input signals was changed. ● The FWD input or the REV input is being ON when the local control operation was switched to the remote control operation. 	<ul style="list-style-type: none"> ● The operation input signal was turned OFF.
Tripmeter	INFO-TRIP	<ul style="list-style-type: none"> ● The rotation amount of the motor exceeded the setting value of the "Tripmeter information" parameter. 	<p>The rotation amount of the motor dropped below the setting value of the "Tripmeter information" parameter by performing the following operation.</p> <ul style="list-style-type: none"> ● The "Tripmeter information" parameter was reset. ● Tripmeter was cleared with the MEXE02.
Odometer	INFO-ODO	<ul style="list-style-type: none"> ● The integrating rotation amount of the motor exceeded the setting value of the "Odometer information" parameter. 	<p>The integrating rotation amount of the motor dropped below the setting value of the "Odometer information" parameter by performing the following operation.</p> <ul style="list-style-type: none"> ● The "Odometer information" parameter was reset.
Main power supply time	INFO-PTIME	<ul style="list-style-type: none"> ● The integrated value of the main power supply time of the driver exceeded the setting value of the "Main power supply time information" parameter. 	<ul style="list-style-type: none"> ● The "Main power supply time information" parameter was set again, and the integrated value of the main power supply time dropped below the setting value of the "Main power supply time information" parameter.
Main power supply count	INFO-PCOUNT	<ul style="list-style-type: none"> ● The number of times for turning on the main power supply of the driver exceeded the setting value of the "Main power supply count information" parameter. 	<ul style="list-style-type: none"> ● The "Main power supply count information" parameter was set again, and the number of times for turning on the main power supply of the driver dropped below the setting value of the "Main power supply count information" parameter.
Operation start limiting mode	INFO-DSLMTD	<ul style="list-style-type: none"> ● The local control operation is performed.* ● Configuration was executed. ● "Teaching, remote operation" was executed using the MEXE02. ● Writing was executed using the MEXE02. ● Initialization was executed. 	<ul style="list-style-type: none"> ● The local control operation was complete. ● Remote control operation was performed. ● Configuration was complete. ● "Teaching, remote operation" was released. ● The initialization was complete.
I/O test mode	INFO-IOTEST	<ul style="list-style-type: none"> ● "I/O test" was executed using the MEXE02. ● Configuration was executed. ● The screen was moved to the "test mode" using the operation panel. 	<ul style="list-style-type: none"> ● I/O test was released. ● Configuration was complete. ● The screen on the operation panel changed to other than the "test mode."
Configuration request	INFO-CFG	<ul style="list-style-type: none"> ● The parameter change required configuration was executed. 	<ul style="list-style-type: none"> ● Configuration was executed.
Power cycling request	INFO-RBT	<ul style="list-style-type: none"> ● The parameter change required to cycle the driver power was executed. 	<ul style="list-style-type: none"> ● The driver power was turned off, and turned on again.

* The ALM LED does not blink when the local control operation is performed.

● Setting value of related parameters

Parameter name	Setting range	Factory setting
Overvoltage information	280 to 440 [V]	435
Undervoltage information	120 to 280 [V]	120
Load information	10 to 300 [%]	300

* Details of parameters ⇒ p.55

- The setting values for the overvoltage information and the undervoltage information represent the main circuit DC voltage value inside the driver.

The main circuit DC voltage is approximately equal to the power input voltage multiplied by the square root of 2.

In the case of single-phase 100-120 VAC types, however, the value is approximately equal to double the power input voltage multiplied by the square root of 2.

<Example> In the case of the input voltage 100 VAC, the main circuit DC voltage inside the driver is about 283 VDC.

In the case of the input voltage 240 VAC, the main circuit DC voltage inside the driver is about 340 VDC.

Specifications

1. Specifications

The value in a state where the gearhead is not combined is described in each specification for the "rated torque," "maximum instantaneous torque," "rated rotation speed" and "speed control range."
Refer to "Products possible to combine" (p.10) for the motor model name.

Model	Motor	BLM230HP _____		BLM460SHP _____ BLM260HP _____	
	Driver	BLE2D30-A	BLE2D30-C	BLE2D60-A	BLE2D60-C
Rated output power (Continuous)		30 W		60 W	
Power supply input	Rated voltage	Single-phase 100-120 VAC	Single-phase 200-240 VAC Three-phase 200-240 VAC	Single-phase 100-120 VAC	Single-phase 200-240 VAC Three-phase 200-240 VAC
	Permissible voltage range	-15 to +10%			
	Rated frequency	50/60 Hz			
	Permissible frequency range	±5%			
	Rated input current	1.1 A	Single-phase: 0.67 A Three-phase: 0.39 A	1.7 A	Single-phase: 1.0 A Three-phase: 0.61 A
	Maximum input current	3.3 A	Single-phase: 2.2 A Three-phase: 1.2 A	5.4 A	Single-phase: 3.5 A Three-phase: 2.0 A
Rated torque		0.096 N·m (13.6 oz-in)		0.191 N·m (27 oz-in)	
Maximum instantaneous torque		0.2 N·m (28 oz-in) [80 to 2000 r/min]		0.4 N·m (56 oz-in) [80 to 2000 r/min]	
Rated rotation speed		3000 r/min			
Speed control range		80 to 4000 r/min *			

* There are products, which maximum rotation speed is 3600 r/min, depending on the gearhead type.
Check the operating manual supplied with the motor.

Model	Motor	BLM5120HP _____		BLM6200SHP _____ BLM5200HP _____	
	Driver	BLE2D120-A	BLE2D120-C	BLE2D200-C	
Rated output power (Continuous)		120 W		200 W	
Power supply input	Rated voltage	Single-phase 100-120 VAC	Single-phase 200-240 VAC Three-phase 200-240 VAC	Single-phase 200-240 VAC Three-phase 200-240 VAC	
	Permissible voltage range	-15 to +10%			
	Rated frequency	50/60 Hz			
	Permissible frequency range	±5%			
	Rated input current	2.7 A	Single-phase: 1.7 A Three-phase: 1.02 A	Single-phase: 2.4 A Three-phase: 1.4 A	
	Maximum input current	7.4 A	Single-phase: 4.8 A Three-phase: 3.3 A	Single-phase: 6.5 A Three-phase: 4.3 A	
Rated torque		0.382 N·m (54 oz-in)		0.637 N·m (90 oz-in)	
Maximum instantaneous torque		0.8 N·m (113 oz-in) [80 to 2000 r/min]		1.15 N·m (163 oz-in) [80 to 2000 r/min]	
Rated rotation speed		3000 r/min			
Speed control range		80 to 4000 r/min *			

* There are products, which maximum rotation speed is 3600 r/min, depending on the gearhead type.
Check the operating manual supplied with the motor.

Model	Motor	BLM6300SHP _____ BLM5300HP _____		BLM6400SHP _____ BLM5400HP _____	
	Driver	BLE2D300-C		BLE2D400-S	
Rated output power (Continuous)		300 W		400 W	
Power supply input	Rated voltage	Single-phase 200-240 VAC Three-phase 200-240 VAC		Three-phase 200-240 VAC	
	Permissible voltage range	-15 to +10%			
	Rated frequency	50/60 Hz			
	Permissible frequency range	±5%			
	Rated input current	Single-phase: 3.2 A Three-phase: 1.8 A		Three-phase: 2.3 A	
	Maximum input current	Single-phase: 8.5 A Three-phase: 6.0 A		Three-phase: 6.1 A	
Rated torque		0.955 N·m (135 oz-in)		1.27 N·m (180 oz-in)	
Maximum instantaneous torque		1.72 N·m (240 oz-in) [80 to 2000 r/min]		2.28 N·m (320 oz-in) [80 to 2000 r/min]	
Rated rotation speed		3000 r/min			
Speed control range		80 to 4000 r/min			

2. General specifications

Operating environment	Ambient temperature	Driver: 0 to +50 °C [+32 to +122 °F] (non-freezing) *
	Ambient humidity	85% or less (non-condensing)
	Altitude	Up to 1000 m (3300 ft.) above sea level
	Surrounding atmosphere	No corrosive gas, dust, water or oil. Cannot be used in radioactive materials, magnetic field, vacuum or other special environment. (For details about installation locations, refer to p.12.)
	Vibration	Not subject to continuous vibrations or excessive impact. In conformance with JIS C 60068-2-6 "Sine-wave vibration test method" Frequency range: 10 to 55 Hz Pulsating amplitude: 0.15 mm (0.006 in.) Sweep direction: 3 directions (X, Y, Z) Number of sweeps: 20 times
Storage environment Shipping environment	Ambient temperature	Driver: -25 to +70 °C [-13 to +158 °F] (non-freezing)
	Ambient humidity	85% or less (non-condensing)
	Altitude	Up to 3000 m (10000 ft.) above sea level
	Surrounding atmosphere	No corrosive gas, dust, water or oil. Cannot be used in radioactive materials, magnetic field, vacuum or other special environment.
Degree of protection		Driver: IP20

* The conditions of use vary when two or more drivers are installed closely in the horizontal direction.
Refer to p.12 for details.

3. Pin assignment

The pin assignments of the connectors for driver connection of the connection cable are shown here.

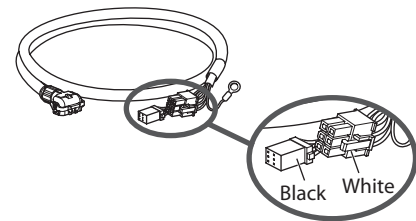

Connectors for driver connection

The following figures represent as the view from the direction of the lead wires side of the connection cable.

• Power connector (white) CN2

Pin No.	Lead color	Lead size
1	Blue	AWG18
2	-	-
3	-	Drain AWG24 or equivalent
4	Purple	AWG18
5	Gray	
6	-	-

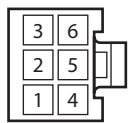

Housing:
5557-06R-210 (molex)
Terminal:
5556T (molex)

• Sensor connector (black) CN4

Pin No.	Lead color	Lead size
A3	-	-
A2	Green	AWG26
A1	Yellow	
B3	Brown	
B2	Red	
B1	Orange	

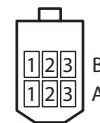

Housing:
J11DF-06V-KY (J.S.T. Mfg. Co.,Ltd.)
Terminal:
SF1F-002GC-P0.6 (J.S.T. Mfg. Co.,Ltd.)

Regulations and standards

1. UL Standards and CSA Standards

This product is recognized by UL under the UL and CSA standards.

Applicable Standards	Certification Body	Standards File No.
UL 61800-5-1 CSA C22.2 No.274	UL	E171462

2. EU Directive

■ CE Marking

This product is affixed the CE Marking under the Low Voltage Directive and EMC Directive.

● Low Voltage Directive

Applicable standards	EN 61800-5-1
Installation conditions (EN Standard)	For incorporating in equipment Overvoltage category: II Pollution degree: 2 Degree of protection: IP20 Protection against electric shock: Class I equipment

- This product is designed and manufactured to be incorporated in equipment.
- This product cannot be used in IT power distribution systems.
- Install the product inside an enclosure in order to avoid contact with hands.
- When a product can be touched with hands, be sure to ground. Ground the Protective Earth Terminals for the motor (or connection cable) and driver securely.
- Isolate power cables such as the connection cable, power supply cable and other drive cables from the signal cable (CN5) and USB cable by means of double insulation.

● EMC Directive

This product has received EMC compliance under the conditions specified in "Example of installation and wiring" on p.78. The final level of conformance of your mechanical equipment to the EMC Directive will vary depending on the control system equipment used with the motor/driver, configuration of electrical parts, wiring, layout, hazard level, and the like. It therefore must be verified through conducting EMC measures on your mechanical equipment.

Applicable standards

EMI	EN 55011 group 1 class A EN 61000-6-4, EN 61800-3
EMS	EN 61000-6-2, EN 61800-3

Caution: This equipment is not intended for use in residential environments nor for use on a low-voltage public network supplied in residential premises, and it may not provide adequate protection to radio reception interference in such environments.

3. Republic of Korea, Radio Waves Act.

KC Mark is affixed to this product under the Radio Waves Act, the republic of Korea.

4. RoHS Directive

The products do not contain the substances exceeding the restriction values of RoHS Directive (2011/65/EU).

5. Installing and wiring in compliance with EMC Directive

This product has been designed and manufactured to be incorporated in equipment. The EMC Directive requires that your mechanical equipment in which the product is installed satisfies the applicable requirements. The installation/wiring methods of the motor and driver explained here represent the basic methods that are effective in helping your mechanical equipment conform to the EMC Directive.

The final level of conformance of your mechanical equipment to the EMC Directive will vary depending on such factors as the control system equipment used with the motor/driver, configuration of electrical parts, wiring, layout and hazard level. It therefore must be verified through conducting EMC measures on your mechanical equipment.

Without effective measures to suppress the electromagnetic interference (EMI) caused by the product in the surrounding control system equipment or the electromagnetic spectrum (EMS) generated by the product, the function of your mechanical equipment may be seriously affected.

This product will conform to the EMC Directive if installed/wired using the methods specified below.

■ Connecting a mains filter

Install a mains filter which the customer provides, in the power line in order to prevent the noise generated within the driver from propagating outside via the AC input line. For mains filters, use the products as shown in the chart, or an equivalent.

Manufacturer	Single-phase 100-120 VAC Single-phase 200-240 VAC	Three-phase 200-240 VAC
Soshin Electric Co., Ltd.	HF2010A-UPF, NF2010A-UP	HF3010C-SZA, NFU3010C-Z1
Schaffner EMC	FN2070-10-06	FN3025HP-10-71

- Overvoltage category II applies to mains filters.
- Install the mains filter as close to the driver as possible.
- Use cable clamps and other means to secure the input and output cables firmly to the surface of the enclosure.
- Connect the ground terminal of the mains filter to the grounding point, using as thick and short wire as possible.
- Do not place the AC input cable (AWG18 to 14: 0.75 to 2.0 mm²) parallel with the mains-filter output cable (AWG18 to 14: 0.75 to 2.0 mm²). Parallel placement will reduce mains filter effectiveness if the enclosure's internal noise is directly coupled to the power supply cable by means of stray capacitance.

■ Connecting the external power supply

Use an external power supply conforming to the EMC Directive. Use a shielded cable for wiring the external power supply over the shortest possible distance. Refer to "Wiring the power supply cable" for how to ground the shielded cable.

■ How to ground

The cable used to ground the motor, driver, mains filter and power supply cable (shielded cable) must be as thick and short as possible so that no potential difference is generated among the grounding points. Choose a large, thick and uniformly conductive surface for the grounding point. Refer to the p.16 for the recommended grounding method.

■ Wiring of the power supply cable

Use a shielded cable of AWG18 to 14 (0.75 to 2.0 mm²) in diameter for the power supply cable and keep it as short as possible. Strip a part of the shielded cable and ground the stripped part using a metal cable clamp that contacts the stripped cable around its entire circumference, or use a drain wire to make the ground connection.

Connect both ends (mains filter side and power supply side) of the shielded cable to the grounding points so that no potential difference is generated between grounds.

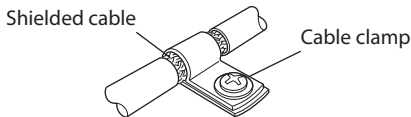

■ Notes about installation and wiring

- Connect the motor, driver and other peripheral control equipment directly to the grounding point so as to prevent a potential difference from developing between grounds.
- When relays or electromagnetic switches are used together with the product, use mains filters or CR circuits to suppress surges generated by them.
- Keep cables as short as possible without coiling and bundling extra lengths.
- Wire the power lines such as the connection cable and power supply cable away from the signal cables by providing a minimum clearance of 100 mm (3.94 in.) between them. If they must cross, do so at a right angle.
- Place the AC input cable and output cable of a mains filter separately from each other.
- Use a dedicated connection cable (sold separately) for the connection between the motor and driver.
The EMC measures are conducted using the Oriental Motor connection cable.

■ Example of installation and wiring

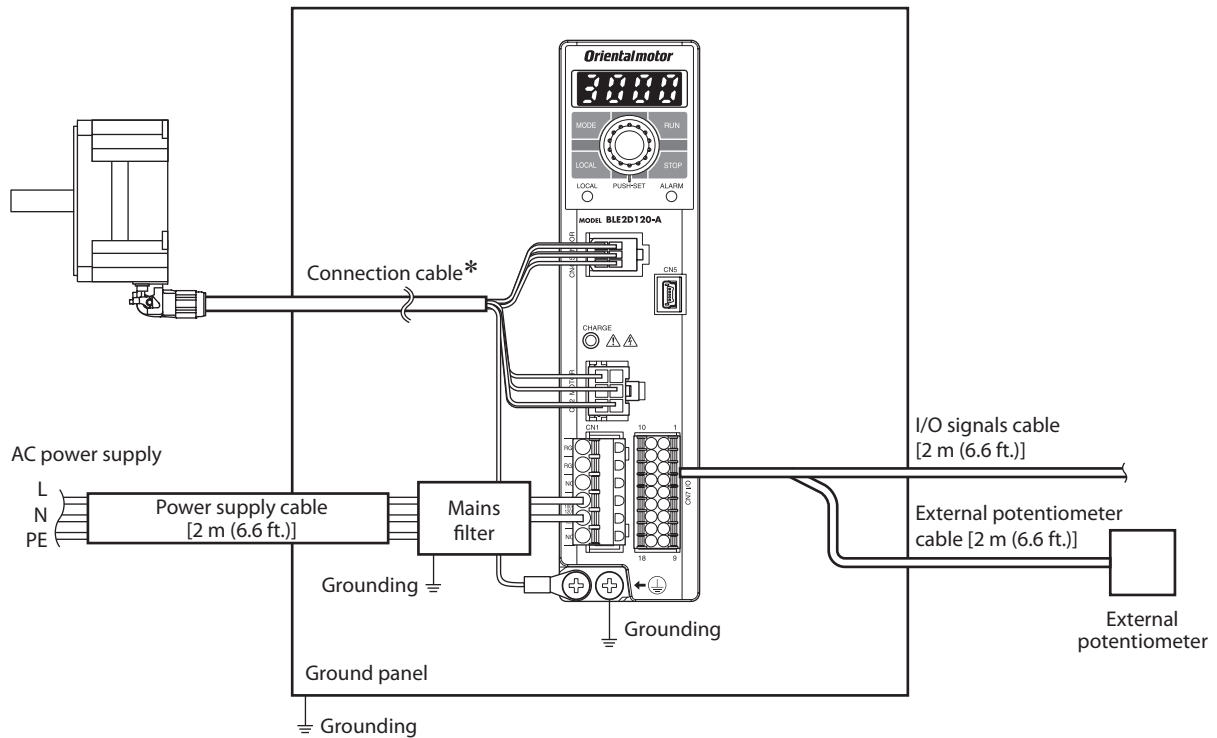

* The connection cables for up to 20.5 m (67.2 ft.) have been evaluated.

■ Precautions about static electricity

Static electricity may cause damage to the driver.

Be sure to ground the product so as to prevent electric shock or product damage by static electricity.

Except when operating the operation panel on the driver, do not approach or touch the driver while the power is on.

Accessories

■ Connection cable

This cable is used to extend the wiring distance between the driver and motor. The wiring distance between the motor and driver can be extended to a maximum of 20.5 m (67.2 ft.).

Flexible connection cables are also provided.

The connection cables and flexible connection cables are shielded cables which have taken measures against the electrical noise. The connection cable for relay can be used by connecting up to 2 pieces.

● Connection cable

Length [m (ft.)]	Model
1 (3.3)	CC01BL2
2 (6.6)	CC02BL2
3 (9.8)	CC03BL2
5 (16.4)	CC05BL2
7 (23.0)	CC07BL2
10 (32.8)	CC10BL2

● Flexible connection cable

Length [m (ft.)]	Model
1 (3.3)	CC01BL2R
2 (6.6)	CC02BL2R
3 (9.8)	CC03BL2R
5 (16.4)	CC05BL2R
7 (23.0)	CC07BL2R
10 (32.8)	CC10BL2R

■ Regeneration resistor

Use when an inertial load is operated with the round shaft type motor of 300 W or higher.

Model: **RGB100**

Install the regeneration resistor in a location where heat dissipation capacity equivalent to a level achieved with a heat sink [made of aluminum, 350×350×3 mm (13.78×13.78×0.12 in.) or equivalent] is ensured.

Secure the regeneration resistor on a smooth metal plate offering high heat conductivity, using two screws (M4, not supplied).

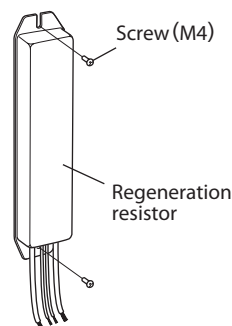

● Battery installation dimensions

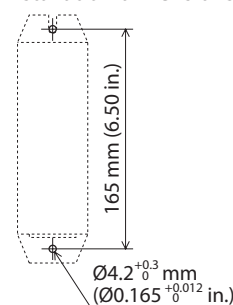

About the mounting bracket (SOL) of the motor

When the mounting bracket and motor are secured, use so that the direction of the connector for motor connection is installed upward or sideways against the installation surface. Installing the motor connector to the downward direction is not recommended since the motor connector is come into contact with the mounting bracket or installation surface.

- Unauthorized reproduction or copying of all or part of this manual is prohibited.
If a new copy is required to replace an original manual that has been damaged or lost, please contact your nearest Oriental Motor branch or sales office.
- Oriental Motor shall not be liable whatsoever for any problems relating to industrial property rights arising from use of any information, circuit, equipment or device provided or referenced in this manual.
- Characteristics, specifications and dimensions are subject to change without notice.
- While we make every effort to offer accurate information in the manual, we welcome your input. Should you find unclear descriptions, errors or omissions, please contact the nearest office.
- **Orientalmotor** is a registered trademark or trademark of Oriental Motor Co., Ltd., in Japan and other countries. Other product names and company names mentioned in this manual may be registered trademarks or trademarks of their respective companies and are hereby acknowledged. The third-party products mentioned in this manual are recommended products, and references to their names shall not be construed as any form of performance guarantee. Oriental Motor is not liable whatsoever for the performance of these third-party products.

© Copyright ORIENTAL MOTOR CO., LTD. 2016

Published in March 2019

- Please contact your nearest Oriental Motor office for further information.

ORIENTAL MOTOR U.S.A. CORP.
Technical Support Tel:(800)468-3982
8:30 A.M. to 5:00 P.M., P.S.T. (M-F)
7:30 A.M. to 5:00 P.M., C.S.T. (M-F)
www.orientalmotor.com

ORIENTAL MOTOR DO BRASIL LTDA.
Tel:+55-11-3266-6018
www.orientalmotor.com.br

ORIENTAL MOTOR (EUROPA) GmbH
Schiessstraße 44, 40549 Düsseldorf, Germany
Technical Support Tel:00 800/22 55 66 22
www.orientalmotor.de

ORIENTAL MOTOR (UK) LTD.
Tel:01256-347090
www.oriental-motor.co.uk

ORIENTAL MOTOR (FRANCE) SARL
Tel:01 47 86 97 50
www.orientalmotor.fr

ORIENTAL MOTOR ITALIA s.r.l.
Tel:02-93906346
www.orientalmotor.it

ORIENTAL MOTOR ASIA PACIFIC PTE. LTD.
Singapore
Tel:1800-8420280
www.orientalmotor.com.sg

ORIENTAL MOTOR (MALAYSIA) SDN. BHD.
Tel:1800-806161
www.orientalmotor.com.my

ORIENTAL MOTOR (THAILAND) CO., LTD.
Tel:1800-888-881
www.orientalmotor.co.th

ORIENTAL MOTOR (INDIA) PVT. LTD.
Tel:+91-80-41125586
www.orientalmotor.co.in

TAIWAN ORIENTAL MOTOR CO., LTD.
Tel:0800-060708
www.orientalmotor.com.tw

SHANGHAI ORIENTAL MOTOR CO., LTD.
Tel:400-820-6516
www.orientalmotor.com.cn

INA ORIENTAL MOTOR CO., LTD.
Korea
Tel:080-777-2042
www.inaom.co.kr

ORIENTAL MOTOR CO., LTD.
Hong Kong Branch
Tel:+852-2427-9800

ORIENTAL MOTOR CO., LTD.
4-8-1 Higashiueno, Taito-ku, Tokyo
110-8536 Japan
Tel:03-6744-0361
www.orientalmotor.co.jp