



OPERATING MANUAL

Brushless Motor

BLM Motor Connector type



Introduction

Before using the motor

Only qualified personnel of electrical and mechanical engineering should work with the product. Use the product correctly after thoroughly reading the section "Safety precautions." In addition, be sure to observe the contents described in warning, caution, and note in this manual. The product described in this manual has been designed and manufactured to be incorporated in general industrial equipment. Do not use for any other purpose. Oriental Motor Co., Ltd. is not responsible for any damage caused through failure to observe this warning.

Related operating manuals

Operating manuals for this product are listed below.

Motor

- **BLM Motor Connector Type OPERATING MANUAL (this document)**
This manual explains the installation method as well as the installation method of a load and others for the motor.

Driver

BMU Series

- **OPERATING MANUAL (included with the driver)**
This manual explains the function, installation and connection methods, troubleshooting, and others for the driver.
- **QUICK START GUIDE (included with the driver)**
This document describes methods till rotating the motor after connecting it to the driver. For details about how to use the product, refer to the OPERATING MANUAL included with the driver.

BLE2 Series

- **OPERATING MANUAL (Basic Function) (included with the driver)**
This manual explains the function, installation and connection methods, troubleshooting, and others for the driver. Refer to the USER MANUAL for details on driver functions and parameters.
- **USER MANUAL**
This manual does not come with the product. For details, contact your nearest Oriental Motor sales office or download from Oriental Motor Website Download Page.

Safety precautions

The precautions described below are intended to prevent danger or injury to the user and other personnel through safe, correct use of the product. Please read and understand these precautions thoroughly before using the product.

WARNING	Handling the product without observing the instructions that accompany a "WARNING" symbol may result in serious injury or death.
CAUTION	Handling the product without observing the instructions that accompany a "CAUTION" symbol may result in injury or property damage.
Note	The items under this heading contain important handling instructions that the user should observe to ensure safe use of the product.

Description of graphic symbols

: Indicates "prohibited" actions that must not be performed.
 : Indicates "compulsory" actions that must be performed.

Thank you for purchasing an Oriental Motor product. This Operating Manual describes product handling procedures and safety precautions.

- Please read it thoroughly to ensure safe operation.
- Always keep the manual where it is readily available.

WARNING

- Do not use the product in explosive or corrosive environments, in the presence of flammable gases or near combustibles. Doing so may result in fire, electric shock or injury.
 - Do not transport, install the product, perform connections or inspections when the power is on. Always turn the power off before carrying out these operations. Failure to do so may result in electric shock or equipment damage.
 - Do not use a motor in a vertical application. If the driver's protection function is activated, the motor will stop and the moving part of the equipment will drop, thereby causing injury or equipment damage.
 - Do not machine or modify the connection cable. Doing so may result in electric shock or fire.
 - Do not apply any excessive force to the motor connector. Doing so may result in fire, electric shock or damage to equipment.
 - Do not forcibly bend, pull or pinch the cables. Doing so may result in fire or electric shock.
 - Do not remove the connector cap until the connection cable is connected so that the O-ring of the connector for cable connection on the motor is not damaged. Doing so may result in fire, electric shock or damage to equipment.
 - Do not touch the motor or driver when conducting insulation resistance measurement or dielectric strength test. Accidental contact may result in electric shock.
 - Do not disassemble or modify the motor and gearhead. Doing so may result in electric shock, injury or equipment damage. Should you require inspection or repair of internal parts, please contact the Oriental Motor branch or sales office from which you purchased the product.
- Only qualified and educated personnel should be allowed to perform installation, connection, operation and inspection/troubleshooting of the product. Handling by unqualified and uneducated personnel may result in fire, electric shock, injury or equipment damage.
- The motor is Class I equipment. When installing the motor and driver, connect their Protective Earth Terminals. Failure to do so may result in electric shock.
 - Use a motor, gearhead, and driver only in the specified combination. An incorrect combination may cause in fire, electric shock or equipment damage.
 - Always turn off the power before performing maintenance/inspection. Failure to do so may result in electric shock.

CAUTION

- Do not use the motor and gearhead beyond the specifications. Doing so may result in fire, electric shock, injury or damage to equipment.
 - Do not touch the motor or gearhead while operating or immediately after stopping. The surface of the motor or gearhead is hot and it may cause a skin burn(s).
 - Do not leave anything around the motor that would obstruct ventilation. Doing so may result in damage to equipment.
 - Do not carry the product by holding the output shaft of the motor or gearhead or any of the cables. Doing so may result in injury.
 - Do not touch the motor output shaft (tip or pinion) with bare hands. Doing so may result in injury.
 - When assembling the motor (pinion shaft) with the gearhead, exercise caution not to pinch your fingers or other parts of your body between the motor and gearhead. Injury may result.
 - When installing the motor or gearhead in the equipment, exercise caution not to pinch your fingers or other parts of your body between the equipment and motor or gearhead. Injury may result.
 - Do not touch the rotating part (output shaft) when operating the motor. Doing so may result in injury.
- Securely install the motor and gearhead to their respective mounting plates. Inappropriate installation may cause the motor and gearhead to detach and fall, resulting in injury or equipment damage.
- Provide a cover on the rotating part (output shaft) of the motor or gearhead. Failure to do so may result in injury.

CAUTION

- Securely install the load on the output shaft of the motor or gearhead. Inappropriate installation may result in injury.
- Be sure to ground the motor and driver to prevent them from being damaged by static electricity. Failure to do so may result in fire or damage to equipment.
- The motor surface temperature may exceed 70 °C (158 °F) even under normal operating conditions. If the operator is allowed to approach a running motor, attach a warning label as shown in the figure in a conspicuous position. Failure to do so may result in skin burn(s).



Precautions for use

This chapter covers restrictions and requirements the user should consider when using the product.

Be sure to match the motor output power with the driver output power.

Wiring

● Connecting the motor and driver

To connect the motor and driver, always use the dedicated connection cable (sold separately).

Limit the number of times so that attaching/detaching between the connection cable and the motor or driver will not exceed 100 times.

● Connection cable

Do not apply a strong force on the locking lever of the connector for motor connection. Applying a strong force on the locking lever may cause damage. Refer to p.6 for details.

Installation circumstances

● Grease measures

On rare occasions, grease may ooze out from the gearhead. If there is concern over possible environmental damage resulting from the leakage of grease, check for grease stains during regular inspections. Alternatively, install an oil pan or other device to prevent leakage from causing further damage. Grease leakage may lead to problems in the customer's equipment or products.

● Note when using in low temperature environment

When an ambient temperature is low, since the load torque may increase by the oil seal or viscosity increment of grease used in the gearhead, the output torque may decrease or an overload alarm may generate. However, as time passes, the oil seal or grease is warmed up, and the motor can be driven without generating an overload alarm.

Operations

● Rotation direction of gearhead output shaft

In the case of the combination type-parallel shaft gearhead, the rotation direction of the gearhead output shaft may differ from that of the motor output shaft depending on the gear ratio of the gearhead.

Gear ratio	Rotation direction of gearhead output shaft
5, 10, 15, 20, 200	Same as the motor output shaft
30, 50, 100*	Opposite to the motor output shaft

* Same as the motor output shaft when the gear ratio is 100:1 for the 200 W type

Insulation resistance measurement and dielectric strength test

● Do not conduct the insulation resistance measurement or dielectric strength test with the motor and driver connected

Conducting the insulation resistance measurement or dielectric strength test with the motor and driver connected may result in damage to the product.

Checking the product

This chapter explains the items you should check, as well as the names of each part.

Package contents

Verify that the items listed below are included.

Report any missing or damaged items to the branch or sales office from which you purchased the product.

Motor 1 unit

Mounting screw 1 set

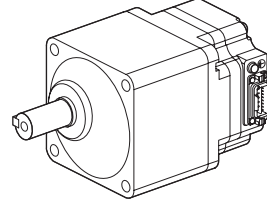

Combination type:
With a gearhead, fixing the parallel key to the output shaft

Included with the combination type.

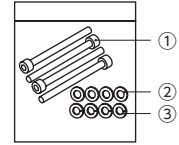

- ① Hexagonal socket head screw: 4 pieces
- ② Plain washer: 4 pieces
- ③ Spring washer: 4 pieces

OPERATING MANUAL (this document) 1 copy

How to identify the product model

BLM 6 200 S H P - 5 A S
① ② ③ ④ ⑤ ⑥ ⑦ ⑧ ⑨

① Motor type	BLM: Brushless Motor
② Frame size	2: 60 mm (2.36 in.) 4: 80 mm (3.15 in.) 5: 90 mm (3.54 in.) 6: 104 mm (4.09 in.)
③ Output power	30: 30 W 60: 60 W 120: 120 W 200: 200 W 400: 400 W
④ Motor classification	S
⑤ Motor connection method	H: Connector type
⑥ Degree of protection for motor	P: IP66
⑦ Gear ratio	Number: Gear ratio of gearhead
⑧ Gearhead shaft type	A: Inch shaft type
⑨ Material of output shaft	S: Stainless steel

Model

Verify the model number of the purchased product against the number shown on the package label. Check the model number of the motor and gearhead against the number shown on their nameplates, respectively.

in the model name indicates a number representing the gear ratio.

● Combination type-parallel shaft gearhead GFV gearhead

Output power	Model	Motor model	Gearhead model
30 W	BLM230HP-□AS	BLM230HP-GFV	GFV2G□AS
60 W	BLM460SHP-□AS	BLM460SHP-GFV	GFV4G□AS
120 W	BLM5120HP-□AS	BLM5120HP-GFV	GFV5G□AS
200 W	BLM6200SHP-□AS	BLM6200SHP-GFV	GFV6G□AS
400 W	BLM6400SHP-□AS	BLM6400SHP-GFV	

Information about nameplate

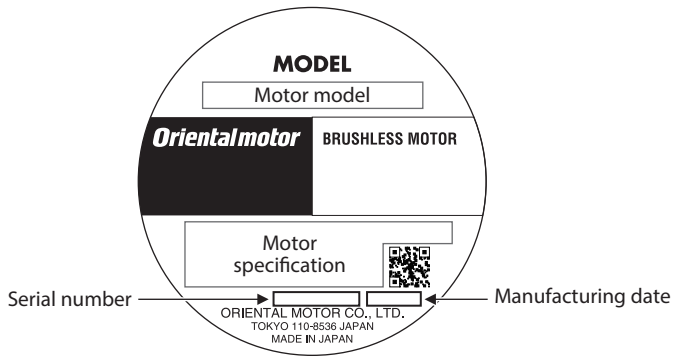

Drivers possible to combine

Products with which the motors can be combined are listed below.

● BMU Series



Output power	Motor model	Driver model	
		Single-phase 100-120 VAC	Single-phase 200-240 VAC Three-phase 200-240 VAC
30 W	BLM230	BMUD30-A2	BMUD30-C2
60 W	BLM460S	BMUD60-A2	BMUD60-C2
120 W	BLM5120	BMUD120-A2	BMUD120-C2
200 W	BLM6200S	BMUD200-A	BMUD200-C
400 W	BLM6400S	—	BMUD400-S*

* The power supply voltage is three-phase 200-240 VAC only.

● BLE2 Series

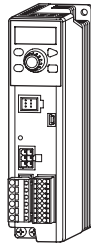

Output power	Motor model	Driver model	
		Single-phase 100-120 VAC	Single-phase 200-240 VAC Three-phase 200-240 VAC
30 W	BLM230	BLE2D30-A	BLE2D30-C
60 W	BLM460S	BLE2D60-A	BLE2D60-C
120 W	BLM5120	BLE2D120-A	BLE2D120-C
200 W	BLM6200S	—	BLE2D200-C
400 W	BLM6400S	—	BLE2D400-S*

* The power supply voltage is three-phase 200-240 VAC only.

Connection cable (sold separately)

To connect the motor and driver, the dedicated connection cable (sold separately) is needed. The distance between the motor and driver is up to 20 m (65.6 ft.). The cable length that can be connected vary depending on the driver used. Check the operating manual included with the driver.

Model name and type

CC 005 **HBL** **F**

Cable length

005 : 0.5 m (1.6 ft.) **040** : 4 m (13.1 ft.)
010 : 1 m (3.3 ft.) **050** : 5 m (16.4 ft.)
015 : 1.5 m (4.9 ft.) **070** : 7 m (23.0 ft.)
020 : 2 m (6.6 ft.) **100** : 10 m (32.8 ft.)
025 : 2.5 m (8.2 ft.) **150** : 15 m (49.2 ft.)
030 : 3 m (9.8 ft.) **200** : 20 m (65.6 ft.)

Cable outlet direction

F : Output shaft direction
B : Opposite to output shaft direction
V : Vertical direction

: Cable classification

Output shaft direction:
CC__F

Opposite to output shaft
direction: **CC__B**

Vertical direction:
CC__V

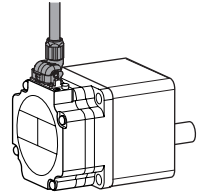
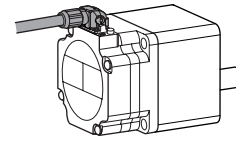
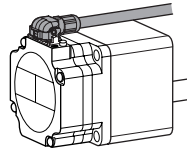

Names of parts

Motor

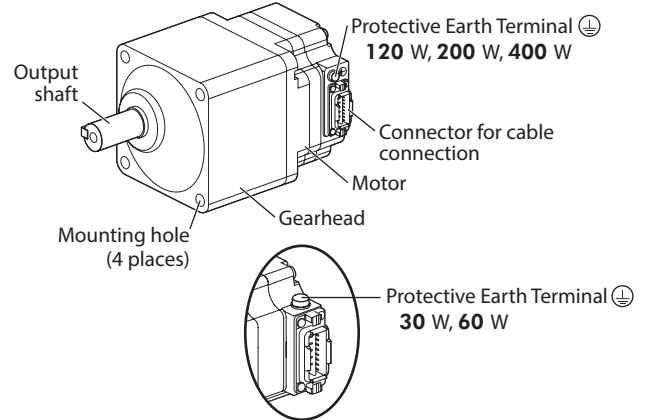

Connection cable (sold separately)

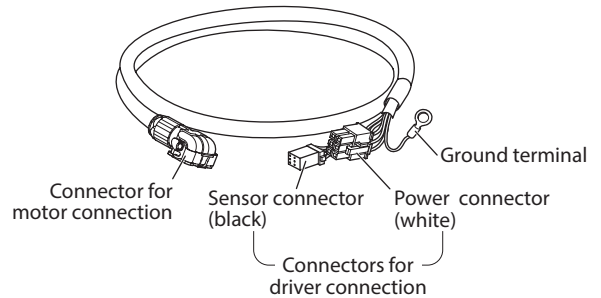

Installation

This section explains the installation method of a load in addition to the installation location and installation method of the product.

Installation location

Install the product in a well-ventilated location that provides easy access for inspection.

- Indoors
- Operating ambient temperature: 0 to +40 °C (+32 to +104 °F) (non-freezing)
- Operating ambient humidity: 85% or less (non-condensing)
- Area that is free of explosive atmosphere or toxic gas (such as sulfuric gas) or liquid
- Area not exposed to direct sun
- Area free of excessive amount of dust, iron particles or the like
- Area free of excessive salt
- Area not subject to continuous vibration or excessive shocks
- Area free of excessive electromagnetic noise (from welders, power machinery, etc.)
- Area free of radioactive materials, magnetic fields or vacuum
- Altitude: Up to 1000 m (3300 ft.) above sea level
- Not exposed to oil (oil droplets) or chemicals.

The motor can be used in an environment that is splashed with water (excluding the part of the connectors for driver connection). Not available for use under high pressure jets of water or immersion in water.

Installation method

Secure the motor through four mounting holes using the included mounting screw set. Do not leave a gap between the motor and mounting plate.

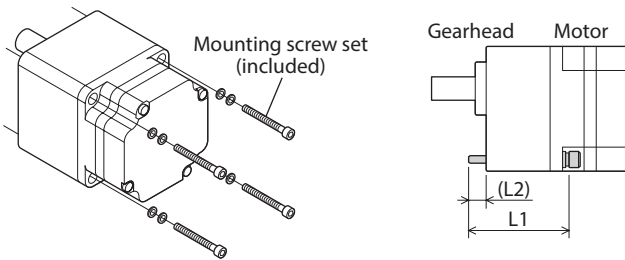

Model	Gear ratio	Hexagonal socket head screw (Material: Stainless steel)			Tightening torque
		Screw size	L1 [mm (in.)]	L2 [mm (in.)]	
BLM230	5 to 20	No.8-32UNC	50.8 (2)	7 (0.28)	1.4 N·m (12.3 lb-in)
	30 to 100		57.2 (2.25)	9 (0.35)	
	200		63.5 (2.5)	11 (0.43)	
BLM460S	5 to 20	1/4-20UNC	63.5 (2.5)	12 (0.47)	5.0 N·m (44 lb-in)
	30 to 100		69.9 (2.75)	13 (0.51)	
	200		76.2 (3)	15 (0.59)	
BLM5120	5 to 20	5/16-18UNC	69.9 (2.75)	12.5 (0.49)	12.0 N·m (106 lb-in)
	30 to 100		82.6 (3.25)	11.5 (0.45)	
	200		88.9 (3.5)	12.5 (0.49)	
BLM6200S BLM6400S*	5 to 20	5/16-18UNC	88.9 (3.5)	16 (0.63)	12.0 N·m (106 lb-in)
	30, 50		101.6 (4)	17 (0.67)	
	100, 200		114.3 (4.5)	15 (0.59)	

* The gear ratio of the BLM6400S is 5:1 to 50:1.

Removing and assembling the gearhead

See the following steps to replace the gearhead or to change the position of the connector for cable connection.

Removing the gearhead from the motor

Remove the hexagonal socket head screws (2 places) assembling the motor and gearhead, and detach the gearhead from the motor.

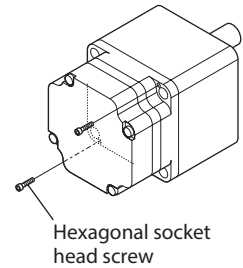

Assembling the gearhead to the motor

1. Keep the pilot sections of the motor and gearhead in parallel, and assemble the gearhead with the motor while slowly rotating it clockwise/counterclockwise. At this time, note so that the pinion of the motor output shaft does not hit the side panel or gears of the gearhead strongly.

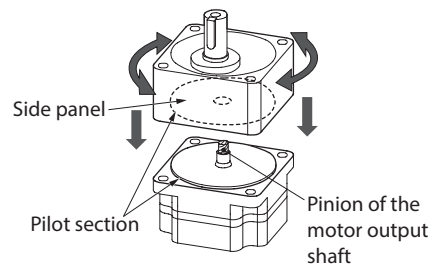

Assemble the gearhead to the motor in a condition where the motor output shaft is in an upward direction.

2. Check that there is no gap between the motor and gearhead, and secure them with hexagonal socket head screws for assembling (2 pieces).

Model	Screw size	Tightening torque
BLM230 BLM460S	M2.6	0.4 N·m (3.5 lb-in)
BLM5120 BLM6200S BLM6400S	M3	0.6 N·m (5.3 lb-in)

Note

- Do not forcibly assemble the motor and gearhead. Also, do not let metal objects or other foreign matter enter the gearhead. The pinion of the motor output shaft or gear may be damaged, resulting in noise or shorter service life.
- Do not allow dust to attach to the pilot sections of the motor and gearhead. Also, assemble the motor and gearhead carefully by not pinching the O-ring at the motor pilot section. If the O-ring is crushed or severed, grease may leak from the gearhead.

■ Installing a load

When installing a load on the gearhead, pay attention to the following points.

- Align the centerline of the gearhead output shaft with the centerline of the load.
- A key slot is provided on the output shaft of each combination type-parallel shaft gearhead. Form a key slot on the load side and secure the load using the parallel key.

Note

- When coupling the gearhead with a load, pay attention to centering, belt tension, parallelism of pulleys, etc. Also, firmly secure the tightening screws of the coupling or pulleys.
- When installing a load, do not damage the gearhead output shaft or bearing. Forcing in the load by driving it with a hammer, etc., may break the bearing. Do not apply any excessive force to the output shaft.
- Do not modify or machine the gearhead output shaft. The bearing may be damaged or the gearhead may break.

When using the output shaft end tapped hole of a gearhead (GFV4G, GFV5G, GFV6G only)

Use a tapped hole provided at the end of the output shaft as an auxiliary means for preventing the transfer mechanism from disengaging.

Gearhead model	Screw size	Effective depth of screw
GFV4G	No.10-24UNC	10 mm (0.39 in.)
GFV5G GFV6G	No.12-24UNC	12 mm (0.47 in.)

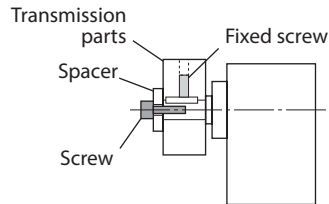

■ Permissible radial load and permissible axial load

The radial load and the axial load on the gearhead output shaft must be kept under the permissible values listed below.

Note

Failure due to fatigue may occur when the bearings and output shaft of the gearhead are subject to repeated loading by a radial or axial load that is in excess of the permissible limit.

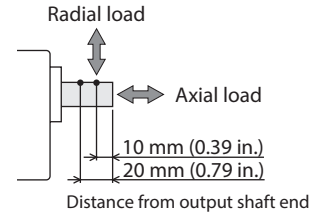

Model	Gear ratio	Permissible radial load [N (lb.)]*1 Distance from output shaft end of the gearhead		Permissible axial load [N (lb.)]
		10 mm (0.39 in.)	20 mm (0.79 in.)	
BLM230	5	100 (22) [90 (20)]	150 (33) [110 (24)]	40 (9.0)
	10 to 20	150 (33) [130 (29)]	200 (45) [170 (38)]	
	30 to 200	200 (45) [180 (40)]	300 (67) [230 (51)]	
BLM460S	5	200 (45) [180 (40)]	250 (56) [220 (49)]	100 (22)
	10 to 20	300 (67) [270 (60)]	350 (78) [330 (74)]	
	30 to 200	450 (101) [420 (94)]	550 (123) [500 (112)]	
BLM5120	5	300 (67) [230 (51)]	400 (90) [300 (67)]	150 (33)
	10 to 20	400 (90) [370 (83)]	500 (112) [430 (96)]	
	30 to 200	500 (112) [450 (101)]	650 (146) [550 (123)]	
BLM6200S BLM6400S*2	5 to 20	550 (123) [500 (112)]	800 (180) [700 (157)]	200 (45)
	30, 50	1000 (220) [900 (200)]	1250 (280) [1100 (240)]	300 (67)
	100, 200	1400 (310) [1200 (270)]	1700 (380) [1400 (310)]	400 (90)

*1 The values assume a rated speed of 3000 r/min or below. The values in [] are based on a rated speed of 4000 r/min.

*2 The gear ratio of the **BLM6400S** is 5:1 to 50:1.

Connection

Connecting the motor and driver

Connect the motor and driver using the connection cable (sold separately). There are three types of connection cables which cable outlet directions are different.

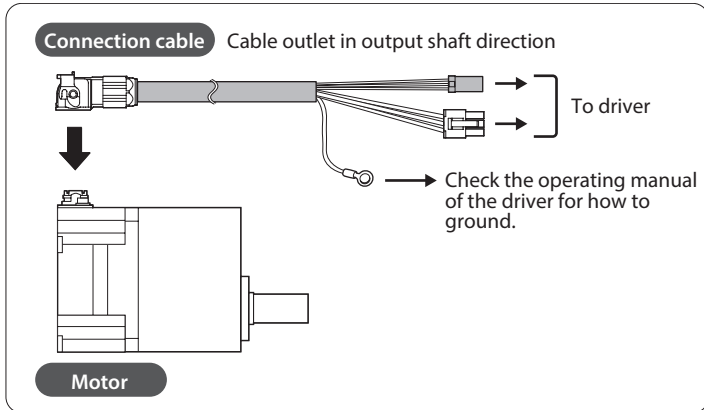

[Cable outlet direction]

Cable outlet in output shaft direction

CC__F

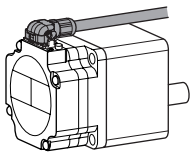

Cable outlet in opposite to output shaft direction

CC__B

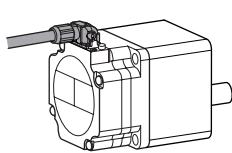

Cable outlet in vertical direction

CC__V

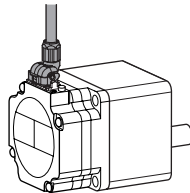

Note Do not apply a strong force on the locking lever of the connector for motor connection. Applying a strong force on the locking lever may cause damage.

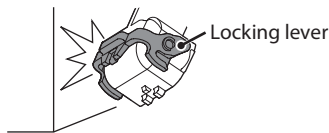

Connection procedures of the motor and connection cable

The following example explains using the connection cable of "cable outlet in output shaft direction."

1 Remove

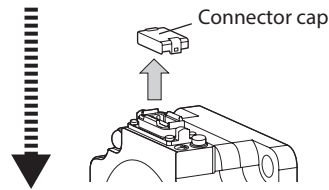

2 Attach

Check the cable outlet direction and insert the connector securely.

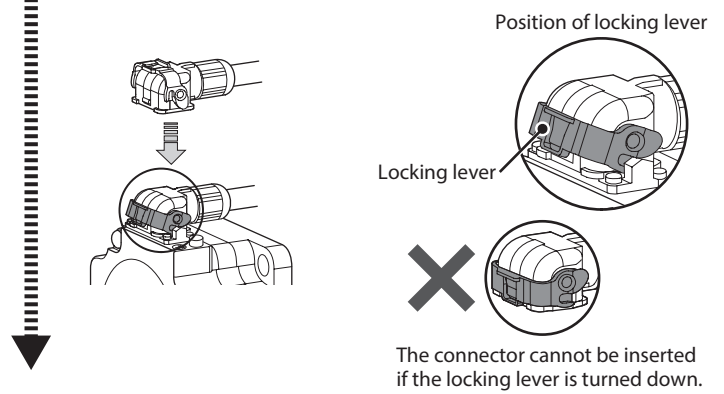

3 Secure

Secure the cable with the locking lever so that the cable does not come off.

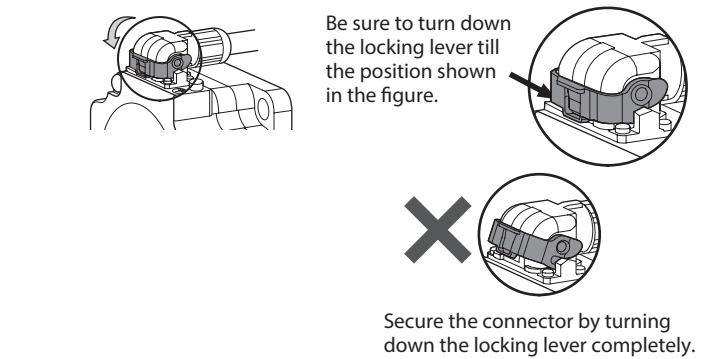

Note Do not lift up the product by holding the connection cable. Doing so may cause damage to the product.

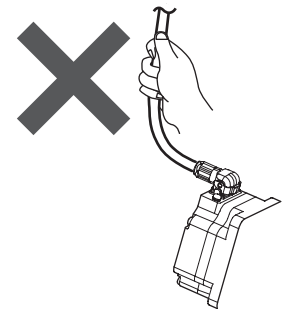

Detaching the connection cable

Turn up the locking lever to detach the cable.

The connection cable for relay can be used by connecting up to 2 pieces. Check the operating manual included with the driver.

Grounding

Ground using the Protective Earth Terminals (⊕) of the motor and driver, as well as the ground terminal of the connection cable. Check the operating manual of the driver for how to ground.

Note

Be sure to ground the motor and driver. Failure to do so may result in electric shock or damage to the product. Static electricity may cause damage to the product if the Protective Earth Terminals are not grounded.

Inspection and maintenance

Inspection

It is recommended that periodic inspections for the items listed below are conducted after each operation of the motor. If an abnormal condition is noted, discontinue any use and contact your nearest Oriental Motor sales office.

Note

Do not conduct the insulation resistance measurement or dielectric strength test with the motor and driver connected. Conducting the insulation resistance measurement or dielectric strength test with the motor and driver connected may result in damage to the product.

Inspection item

- Check if any of the mounting screws of the motor and gearhead is loose.
- Check if the bearing part (ball bearings) of the motor generates unusual noises.
- Check if the bearing part (ball bearings) or gear meshing part of the gearhead generates unusual noises.
- Check if the gearhead output shaft and a load shaft are out of alignment.
- Check if a damage or stress is applied on the cable or the connection part between the cable and driver is loose.

Warranty

Check on the Oriental Motor Website for the product warranty.

Disposal

Dispose the product correctly in accordance with laws and regulations, or instructions of local governments.

Peripheral equipment (sold separately)

Peripheral equipment such as couplings and mounting brackets can be checked on the Oriental Motor Website.

About motor mounting brackets (SOL)

When the mounting bracket and motor are secured, use so that the direction of the connector for cable connection is installed upward or sideways against the installation surface. Installing the motor connector to the downward direction is not recommended since the motor connector is come into contact with the mounting bracket or installation surface.

Specifications

Check on the Oriental Motor Website for the product specifications.

General specifications

Operation environment	Ambient temperature	0 to +40 °C [+32 to +104 °F] (non-freezing)
	Ambient humidity	85% or less (non-condensing)
	Altitude	Up to 1000 m (3300 ft.) above sea level
	Surrounding atmosphere	No corrosive gas or dust. Cannot be used in radioactive materials, magnetic field, vacuum or other special environment. Details about the installation location are described on p.4.
Vibration		Not subject to continuous vibrations or excessive impact. In conformance with JIS C 60068-2-6 "Sine-wave vibration test method" Frequency range: 10 to 55 Hz Pulsating amplitude: 0.15 mm (0.006 in.) Sweep direction: 3 directions (X, Y, Z) Number of sweeps: 20 times
Storage environment	Ambient temperature	-20 to +70 °C [-4 to +158 °F] (non-freezing)
	Ambient humidity	85% or less (non-condensing)
Shipping environment	Altitude	Up to 3000 m (10000 ft.) above sea level
	Surrounding atmosphere	No corrosive gas, dust, water or oil. Cannot be used in radioactive materials, magnetic field, vacuum or other special environment.
Degree of protection		IP66 (IP66 for when the connection cable is attached to the motor. Excluding the part of the connectors for driver connection.)

Regulations and standards

UL Standards and CSA Standards

This product is recognized by UL under the UL and CSA standards. The motor model name represents the model that conforms to the standards.

Applicable Standards	Certification Body	Standards File No.
UL 1004-1 CSA C22.2 No.100	UL	E335369

* Thermal class UL/CSA Standards: 105(A)

CE Marking

This product is affixed the CE Marking under the Low Voltage Directive. The motor model names are the models conform to the directive (CE Marking).

● Low Voltage Directive

- This product is designed and manufactured to be incorporated in equipment.
- This product cannot be used in IT power distribution systems.
- Install the product within the enclosure in order to avoid contact with hands.
- Ground the Protective Earth Terminals for the motor (or connection cable) and driver securely.
- Isolate the connection cable, power-supply cable and other drive cables from the signal cables by means of double insulation.

Applicable Standards

EN 60034-1, EN 60034-5, EN 60664-1

Installation conditions (EN Standard)

- For incorporating in equipment
- Overvoltage category: II
- Pollution degree: 3
- Protection against electric shock: Class I

* Thermal class EN Standards: 120(E)

● Motor temperature rise tests

The temperature rise tests stipulated in the above standards are conducted in a state where a motor is mounted on a heat radiation plate instead of attaching a gearhead. The size, thickness and material of the heat radiation plates are as follows.

Model	Size [mm (in.)]	Thickness [mm (in.)]	Material
BLM230	115×115 (4.53×4.53)	5 (0.20)	Aluminum alloy
BLM460S	135×135 (5.31×5.31)		
BLM5120	165×165 (6.50×6.50)		
BLM6200S	200×200 (7.87×7.87)		
BLM6400S	250×250 (9.84×9.84)	6 (0.24)	

RoHS Directive

The products do not contain the substances exceeding the restriction values of RoHS Directive (2011/65/EU).

- Unauthorized reproduction or copying of all or part of this manual is prohibited.
- Oriental Motor shall not be liable whatsoever for any problems relating to industrial property rights arising from use of any information, circuit, equipment or device provided or referenced in this manual.
- Characteristics, specifications and dimensions are subject to change without notice.
- While we make every effort to offer accurate information in the manual, we welcome your input. Should you find unclear descriptions, errors or omissions, please contact the nearest office.
- **Orientalmotor** is a registered trademark or trademark of Oriental Motor Co., Ltd., in Japan and other countries.

© Copyright ORIENTAL MOTOR CO., LTD. 2016

Published in January 2020

• Please contact your nearest Oriental Motor office for further information.

ORIENTAL MOTOR U.S.A. CORP.
Technical Support Tel:(800)468-3982
8:30 A.M. to 5:00 P.M., P.S.T. (M-F)
7:30 A.M. to 5:00 P.M., C.S.T. (M-F)
www.orientalmotor.com

ORIENTAL MOTOR DO BRASIL LTDA.
Tel:+55-11-3266-6018
www.orientalmotor.com.br

ORIENTAL MOTOR (EUROPA) GmbH
Schiesstraße 44, 40549 Düsseldorf, Germany
Technical Support Tel:00 800/22 55 66 22
www.orientalmotor.de

ORIENTAL MOTOR (UK) LTD.
Tel:01256-347090
www.oriental-motor.co.uk

ORIENTAL MOTOR (FRANCE) SARL
Tel:01 47 86 97 50
www.orientalmotor.fr

ORIENTAL MOTOR ITALIA s.r.l.
Tel:02-93906346
www.orientalmotor.it

ORIENTAL MOTOR CO., LTD.
4-8-1 Higashiueno, Taito-ku, Tokyo 110-8536
Japan
Tel:03-6744-0361
www.orientalmotor.co.jp

ORIENTAL MOTOR ASIA PACIFIC PTE. LTD.
Singapore
Tel:1800-8420280
www.orientalmotor.com.sg

ORIENTAL MOTOR (MALAYSIA) SDN. BHD.
Tel:1800-806161
www.orientalmotor.com.my

ORIENTAL MOTOR (THAILAND) CO., LTD.
Tel:1800-888-881
www.orientalmotor.co.th

ORIENTAL MOTOR (INDIA) PVT. LTD.
Tel:+91-80-41125586
www.orientalmotor.co.in

TAIWAN ORIENTAL MOTOR CO., LTD.
Tel:0800-060708
www.orientalmotor.com.tw

SHANGHAI ORIENTAL MOTOR CO., LTD.
Tel:400-820-6516
www.orientalmotor.com.cn

INA ORIENTAL MOTOR CO., LTD.
Korea
Tel:080-777-2042
www.inaom.co.kr

ORIENTAL MOTOR CO., LTD.
Hong Kong Branch
Tel:+852-2427-9800