



Stepping Motor *αSTEP*

AZ Series/

Motorized actuator equipped with AZ Series

AC power input

-  Built-in controller type
- Pulse input type with RS-485 communication interface
- Pulse input type

OPERATING MANUAL Driver Edition



Table of contents

1	Introduction	2	10	Guidance	35
2	Safety precautions	5	11	Inspection and maintenance	47
3	Precautions for use.....	7	12	Alarm (protective function).....	48
4	Regulations and standards.....	8	13	Troubleshooting	49
5	Preparation	10	14	To use the product in more convenient manners	51
6	Installation.....	13	15	Cables	52
7	Connection	15	16	Accessories.....	55
8	Explanation of I/O signals	28			
9	Setting	31			

Thank you for purchasing an Oriental Motor product.
This Manual describes product handling procedures and safety precautions.

- Please read it thoroughly to ensure safe operation.
- Always keep the manual where it is readily available.

1 Introduction

■ Before use

Only qualified personnel of electrical and mechanical engineering should work with the product. Use the product correctly after thoroughly reading the "2 Safety precautions" on p.5. In addition, be sure to observe the contents described in warning, caution, and note in this manual. The product described in this manual is designed and manufactured to be incorporated in general industrial equipment. Do not use for any other purpose. Oriental Motor Co., Ltd. is not responsible for any compensation for damage caused through failure to observe this warning.



This manual, unless otherwise noted, explains using figures of the built-in controller type driver.

■ Related operating manuals

For operating manuals, contact your nearest Oriental Motor sales office or download from Oriental Motor Website Download Page.

Operating manual name	Included or not included with product
AZ Series/Motorized actuator equipped with AZ Series OPERATING MANUAL Driver Edition (this document)	Not included
AZ Series/Motorized actuator equipped with AZ Series OPERATING MANUAL Function Edition	Not included
APPENDIX UL Standards for AZ Series	Not included

■ General specifications

Degree of protection		IP20: Pulse input type IP10: Built-in controller type, Pulse input type with RS-485 communication interface
Operation environment	Ambient temperature	0 to +55 °C (+32 to +131 °F) * (non-freezing)
	Humidity	85 % or less (non-condensing)
	Altitude	Up to 1,000 m (3,300 ft.) above sea level
	Surrounding atmosphere	No corrosive gas, dust, water or oil
Storage environment, Shipping environment	Ambient temperature	-25 to +70 °C (-13 to +158 °F) (non-freezing)
	Humidity	85 % or less (non-condensing)
	Altitude	Up to 3,000 m (10,000 ft.) above sea level
	Surrounding atmosphere	No corrosive gas, dust, water or oil

* When installing a driver on a heat sink. [material: aluminum, 200×200×2 mm (7.87×7.87×0.08 in.) equivalent].

Insulation resistance	100 MΩ or more when 500 VDC megger is applied between the following places: <ul style="list-style-type: none"> • Protective Earth Terminals - Main power supply terminals • Encoder connector - Main power supply terminals • Signal I/O terminals - Main power supply terminals
Dielectric strength	Sufficient to withstand the following for 1 minute: <ul style="list-style-type: none"> • Protective Earth Terminals - Main power supply terminals 1.5 kVAC 50/60 Hz • Encoder connector - Main power supply terminals 1.8 kVAC 50/60 Hz • Signal I/O terminals - Main power supply terminals 1.8 kVAC 50/60 Hz

■ RS-485 communication specification

Electrical characteristics	Compliant with EIA-485, straight cable Use a twist pair cable (TIA/EIA-568B CAT5e or higher is recommended) and keep the total wiring distance up to 50 m (164 ft). *
Communication mode	Half-duplex communication Asynchronous mode (data: 8 bits, stop bit: 1 bit/2 bits, parity: none/even number/odd number)
Transmission rate	Selectable from 9,600 bps, 19,200 bps, 38,400 bps, 57,600 bps, 115,200 bps, and 230,400 bps
Protocol	Modbus RTU mode
Number of connectable units	Up to 31 units can be connected to one host controller.

* If the motor cable or power supply cable generates an undesirable amount of noise depending on the wiring or configuration, shield the cable or install a ferrite core.

■ About terms and units

Terms and units to be used vary depending on a motor or motorized actuator. This manual explains by using the terms of the motor. When the motorized actuator is used, read this manual by replacing the terms.



	Motor	Motorized actuator
Term	Torque	Thrust
	Moment of inertia	Mass
	Rotation	Movement
	CW direction	Forward direction
	CCW direction	Reverse direction
	Rotation speed	Speed
	Resolution	Minimum travel amount
Unit	N·m	N
	kHz/s	m/s ²

Types and overview of driver

There are three types of drivers in the AZ Series as shown below. I/O signals, setting items, and LEDs vary depending on the driver type.

Built-in controller type

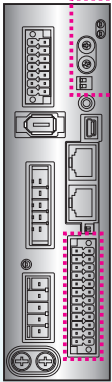
- Operates via industrial network
- Monitors the motor information via a host controller or touchscreen
- Operates via RS-485 communication
- Operates via I/O control



- PWR/ALM LED
- C-DAT/C-ERR LED
- Address number
- Transmission rate
- Function setting switch
 - Protocol
 - Address number (extended)

Pin Nos. 1, 2, 13, and 14 are for control input

Pin No.1	DIN0 [START]
Pin No.2	DIN2 [M1]
Pin No.13	DIN1 [M0]
Pin No.14	DIN3 [M2]

Pulse input type with RS-485 communication interface

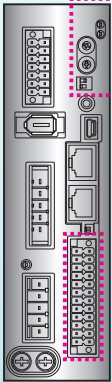
- Operates via industrial network
- Monitors the motor information via a host controller or touchscreen
- Operates via RS-485 communication
- Operates via I/O control
- Operates by pulse input



- PWR/ALM LED
- C-DAT/C-ERR LED
- Address number
- Transmission rate
- Function setting switch
 - Protocol
 - Address number (extended)

Pin Nos. 1, 2, 13, and 14 are for pulse input

Pin No.1	CW+ [PLS+]
Pin No.2	CCW+ [DIR+]
Pin No.13	CW- [PLS-]
Pin No.14	CCW- [DIR-]

Pulse input type

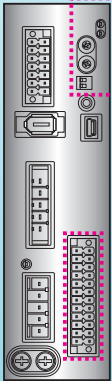
- Operates by pulse input

- PWR/ALM LED
- READY LED
- Base current rate
- Command filter
- Function setting switch
 - Pulse input mode
 - Resolution



Pin Nos. 1, 2, 13, and 14 are for pulse input

Pin No.1	CW+ [PLS+]
Pin No.2	CCW+ [DIR+]
Pin No.13	CW- [PLS-]
Pin No.14	CCW- [DIR-]



2 Safety precautions





The precautions described below are intended to ensure the safe and correct use of the product, and to prevent the customer and others from exposure to the risk of injury. Use the product only after carefully reading and fully understanding these instructions.

Description of signs

 WARNING	Handling the product without observing the instructions that accompany a "WARNING" symbol may result in serious injury or death.
 CAUTION	Handling the product without observing the instructions that accompany a "CAUTION" symbol may result in injury or property damage.
 Note	The items under this heading contain important handling instructions that the user should observe to ensure the safe use of the product.

Description of graphic symbols

	Indicates "prohibited" actions that must not be performed.
	Indicates "compulsory" actions that must be performed.

 WARNING	
	<ul style="list-style-type: none"> Do not use the driver in explosive or corrosive environments, in the presence of flammable gases, in places subjected to splashing water, or near combustibles. Doing so may result in fire, electric shock, or injury. Do not transport, install, connect, or inspect the driver while the power is supplied. Doing so may result in electric shock. Do not touch the driver while the power is supplied. Doing so may result in fire or electric shock. Do not forcibly bend, pull, or pinch the cable. Doing so may result in fire or electric shock. Do not remove the motor excitation during operation. Doing so may cause the motor to stop and lose the holding force, resulting in injury or damage to equipment. Do not disassemble or modify the driver. Doing so may result in injury or damage to equipment. Do not touch the terminals indicated   signs on the driver's front panel while the power is supplied because high voltage is applied. Doing so may result in fire or electric shock. Do not touch the connection terminals of the driver immediately after turning off the main power supply and the control power supply. Before performing connection or inspection, turn off the main power supply and the control power supply, and check the CHARGE LED has been turned off. Residual voltage may cause electric shock.
	<ul style="list-style-type: none"> Assign qualified personnel to the task of installing, wiring, operating/controlling, inspecting, and troubleshooting the driver. Failure to do so may result in fire, electric shock, injury, or damage to equipment. Take measures to keep the moving part in position if the product is used in vertical operations such as elevating equipment. Failure to do so may result in injury or damage to equipment. When an alarm is generated in the driver (any of the driver's protective functions is triggered), remove the cause before clearing the alarm (protective function). Continuing the operation without removing the cause of the problem may cause malfunction of the motor and the driver, leading to injury or damage to equipment. Install the driver inside an enclosure. Failure to do so may result in electric shock or injury. Always keep the power supply voltage of the driver within the specified range. Failure to do so may result in fire or electric shock. The driver is Class I equipment. When installing the driver, install it inside an enclosure so that it is out of the direct reach of users. Be sure to ground if users can touch it. Failure to do so may result in electric shock.

⚠ WARNING	
!	<ul style="list-style-type: none"> • Connect the product securely according to the wiring diagram. Failure to do so may result in fire or electric shock. • Turn off the main power supply and the control power supply in the event of a power failure. Failure to do so may result in injury or damage to equipment.

⚠ CAUTION	
⊘	<ul style="list-style-type: none"> • Do not use the driver beyond its specifications. Doing so may result in electric shock, injury, or damage to equipment. • Keep your fingers and objects out of the openings in the driver. Failure to do so may result in fire, electric shock, or injury. • Do not touch the driver during operation or immediately after stopping. Doing so may result in a skin burn(s). • Keep the area around the driver free of combustible materials. Failure to do so may result in fire or a skin burn(s). • Do not forcibly bend or pull the cable that is connected to the driver. Doing so may result in damage. • Do not touch the terminals while conducting the insulation resistance measurement or the dielectric strength test. Doing so may cause electric shock. • Do not leave anything around the driver that would obstruct ventilation. Doing so may result in damage to equipment.
!	<ul style="list-style-type: none"> • Use a motor and a driver only in the specified combination. An incorrect combination may cause a fire. • Take measures against static electricity when operating the switches of the driver. Failure to do so may result in the driver malfunction or damage to equipment. • Provide an emergency stop device or emergency stop circuit external to the equipment so that the entire equipment will operate safely in the event of a system failure or malfunction. Failure to do so may result in injury. • When moving the moving part manually, put the motor into a non-excitation state. Continuing the work while the motor is in an excitation state may result in injury. • Immediately when a problem occurred, stop operation and turn off the main power supply and the control power supply. Failure to do so may result in fire, electric shock or injury. • Before turning on the main power supply and the control power supply, turn all input signals to the driver to OFF. Failure to do so may result in injury or damage to equipment. • For the control power supply, use a DC power supply with reinforced insulation on its primary and secondary sides. Failure to do so may result in electric shock.

■ Warning sign

A warning about handling precautions is described on the driver. Be sure to observe the description contents when handling the driver.

Electrical hazard warning label

⚠ WARNING	– Risk of electric shock.
⚠	<ul style="list-style-type: none"> • Read manual before installing. (Multiple rated) • Do not touch the driver immediately after the power is cut off, or until the CHARGE LED (lit in red) turns off. Doing so may result in electric shock due to residual voltage.
⚠ AVERTISSEMENT	– Risque de décharge électrique.
⚠	<ul style="list-style-type: none"> • Lire le manuel avant l'installation. • Ne pas toucher au variateur immédiatement après la mise hors tension ou avant que la LED "présence de la tension" (Rouge) ne soit éteinte. Le non respect de ces règles pourrait entraîner un choc électrique.
⚠ 警 告	– けが・感電のおそれがあります。
⚠	<ul style="list-style-type: none"> • 組み付け、運転の前には必ず取扱説明書をお読み下さい。 • 電源を切った直後、CHARGE LED(赤色点灯)が消灯するまでドライバに触れないで下さい。残電圧により感電の危険があります。

Material: PET

3 Precautions for use

This chapter covers restrictions and requirements the user should consider when using the product.

- **Be sure to use our cable to connect the motor and driver.**

Refer to p.52 for the model name of cables.

- **When conducting the insulation resistance measurement or the dielectric strength test, be sure to separate the connection between the motor and the driver.**

Conducting the insulation resistance measurement or dielectric strength test with the motor and driver connected may result in damage to the product.

- **Preventing leakage current**

Stray capacitance exists between the driver's current-carrying line and other current-carrying lines, the earth and the motor, respectively. A high-frequency current may leak out through such capacitance, having a detrimental effect on the surrounding equipment. The actual leakage current depends on the driver's switching frequency, the length of wiring between the driver and motor, and so on. When connecting an earth leakage breaker, use one of the following products offering resistance against high frequency current:

Mitsubishi Electric Corporation: NV series

- **Saving data to the non-volatile memory**

Do not turn off the control power supply while writing the data to the non-volatile memory, and also do not turn off for 5 seconds after the completion of writing the data. Doing so may abort writing the data and cause an EEPROM error alarm to generate. The non-volatile memory can be rewritten approximately 100,000 times.

- **If vertical drive (gravitational operation) such as elevator applications is performed or if sudden start-stop operation of a large inertial load is repeated frequently, connect our regeneration resistor.**

The overvoltage alarm may generate depending on the operating condition of the motor.

When the overvoltage alarm has generated, review the operating conditions or connect our regeneration resistor.

Refer to p.17 for connection method.

- **Note on connecting a control power supply whose positive terminal is grounded**

The USB communication connector, CN5, CN6 (*) and CN7 (*) connector are not insulated. When grounding the positive terminal of the control power supply, do not connect any equipment (PC, etc.) whose negative terminal is grounded. Doing so may cause the driver and this equipment to short, damaging both. When connecting, do not ground equipment.

* Excluding the pulse input type.

4 Regulations and standards

4-1 UL Standards

Check the "APPENDIX UL Standards for AZ Series" for recognition information about UL Standards.

4-2 EU Directives

■ CE Marking

This product is affixed the CE Marking under the Low Voltage Directive, Machinery Directive and EMC Directive.

● Low Voltage Directive

Applicable Standard	EN 61800-5-1
Installation condition (EN Standards)	To be incorporated in equipment. Overvoltage category: II Pollution degree: 2 Degree of protection: IP20 (Pulse input type) IP10 (Built-in controller type, Pulse input type with RS-485 communication interface) Protection against electric shock: Class I

- This product cannot be used in IT power distribution systems.
- Install the product within the enclosure in order to avoid contact with hands.
- When a product can be touched with hands, be sure to ground. Make sure to ground the Protective Earth Terminals of the motor and driver.
- To protect against electric shock using an earth leakage breaker (RCD), connect a type B earth leakage breaker to the primary side of the driver.
- When using a circuit breaker (MCCB), use a unit conforming to the EN or IEC standard.
- Isolate the motor cable, power-supply cable and other drive cables from the signal cables (CN1, CN5) by means of double insulation.
- The temperature of the driver's heat sink may exceed 90 °C (194 °F) depending on the driving conditions. Accordingly, take heed of the following items:
 - Do not touch the driver.
 - Do not use the driver near flammable objects.
 - Always conduct a trial operation to check the driver temperature.

● Machinery Directive

Applicable Standards: EN ISO 12100, EN 61800-5-2, EN 62061, EN ISO 13849-1: 2015

● EMC Directive

This product is conducted EMC testing under the conditions specified in "Example of motor and driver installation and wiring" on p.27. The conformance of your mechanical equipment with the EMC Directive will vary depending on such factors as the configuration, wiring, and layout for other control system devices and electrical parts used with this product. It therefore must be verified through conducting EMC measures in a state where all parts including this product have been installed in the equipment.

Applicable Standards

EMI	EN 55011 Group1 Class A, EN 61000-6-4, EN 61800-3
EMS	EN 61000-6-2, EN 61800-3

CAUTION

This equipment is not intended for use in residential environments nor for use on a low-voltage public network supplied in residential premises, and it may not provide adequate protection to radio reception interference in such environments.

4-3 Functional safety

This product is certified by TÜV SÜD Product Service GmbH under the following standards and affixed the TÜV SÜD Mark. It is not a certified product if the TÜV SÜD Mark is not affixed.

Applicable Standards	Functional safety	IEC 61800-5-2, EN 61800-5-2 IEC 61508-1, EN 61508-1 IEC 61508-2, EN 61508-2 IEC 62061, EN 62061 ISO 13849-1: 2015, EN ISO 13849-1: 2015
	Electrical safety	EN 61800-5-1
	EMC	IEC 61000-6-7, EN 61000-6-7
Safety function		STO (Power removal function)



For details about power removal function (STO function), refer to the [OPERATING MANUAL AZ Series Function Edition](#).

4-4 Republic of Korea, Radio Waves Act

This product is affixed the KC Mark under the Republic of Korea, Radio Waves Act.

4-5 RoHS Directive

The products do not contain the substances exceeding the restriction values of RoHS Directive (2011/65/EU).

5 Preparation

This chapter explains the items you should check, as well as the name and function of each part.

5-1 Checking the product

Verify that the items listed below are included. Report any missing or damaged items to the Oriental Motor sales office from which you purchased the product.

- Driver 1 unit
- CN1 connector (14 pins) 1 pc.
- CN4 connector (5 pins) 1 pc.
- CN5 connector (24 pins) 1 pc.
- Connector wiring lever 1 pc. (for CN4 connector)
- Instructions and Precautions for Safe Use 1 copy

5-2 Names and functions of parts

- Built-in controller type
Pulse input type with RS-485 communication interface

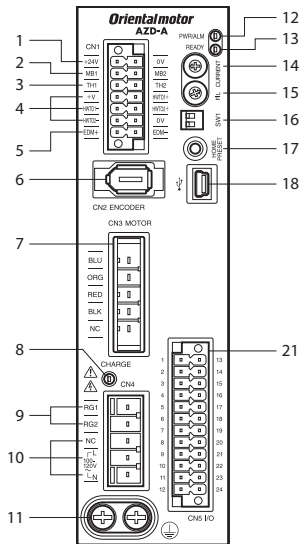
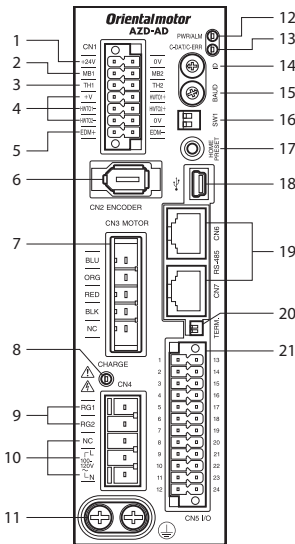

The figure shows the built-in controller type driver.

- Pulse input type



■ Connector, terminal

Names, indication, and functions for connectors and terminals are common to all drivers.
The RS-485 communication connectors (CN6 and CN7) are not provided in the pulse input type drivers.

	Name	Display	Description
1	24 VDC power supply input terminals (CN1)	+24V, 0V	Connects the control power supply of the driver. +24V: +24 VDC power supply input 0V: Power supply ground
2	Electromagnetic brake terminals (CN1)	MB1, MB2	Connects the lead wires from the electromagnetic brake. MB1: Electromagnetic brake- (Black) MB2: Electromagnetic brake+ (White)
3	Regeneration resistor thermal input terminals (CN1)	TH1, TH2	Connects the signal line of our regeneration resistor. Refer to p.17 for connection method. If no regeneration resistor is connected, short the TH1 and TH2 terminals.
4	Power removal signal input terminals (CN1)	HWTO1+, HWTO1- HWTO2+, HWTO2-	Connects the external device.
5	Power removal monitor output terminals (CN1)	EDM+, EDM-	Connects the external device.
6	Encoder connector (CN2)	ENCODER	Connects the encoder.
7	Motor connector (CN3)	MOTOR	Connects the motor.
9	Regeneration resistor terminals (CN4)	RG1, RG2	Connects our regeneration resistor. Refer to p.17 for connection method.
10	Main power supply input terminals (CN4)	L, N, NC L1, L2, NC L1, L2, L3	Connects the main power supply.
11	Protective Earth Terminals		Used for grounding via a grounding cable of AWG16 to 14 (1.25 to 2.0 mm ²).
18	USB communication connector		Connects the PC in which the support software MEXE02 has been installed. (USB2.0 mini-B port)
19	RS-485 communication connectors (CN6/CN7)	RS-485	Connects the RS-485 communication cable.
21	Input/output signal connector (CN5)	I/O	Connects the input/output signals.

■ LED, switch

Names, indication, and functions for LEDs and switches vary depending on the driver type. Check in the following tables.

● Built-in controller type, Pulse input type with RS-485 communication interface

	Name	Display	Description
8	CHARGE LED (Red)	CHARGE	This LED is lit while the main power is input. After the main power was turned off, the LED will turn off once the residual voltage in the driver drops to a safe level.
12	PWR/ALM LED (Green/Red)	PWR/ALM	<ul style="list-style-type: none"> • This LED is lit in green while the control power supply is input. • If an alarm (protective function) generates, the LED will blink in red. • If the power removal function is triggered, the LED will blink in green. • If information generates, the LED will blink in red and green simultaneously. (Red and green colors may overlap and it may be visible to orange.)
13	C-DAT/C-ERR LED (Green/Red)	C-DAT/C-ERR	<ul style="list-style-type: none"> • This LED will blink or illuminate in green when the driver is communicating with the host controller properly via RS-485 communication. • This LED will illuminate in red when a RS-485 communication error occurs with the host controller.
14	Address number setting switch	ID	Use this switch when controlling the system via RS-485 communication. Use this switch and SW1-No.1 of the function setting switch, to set the address number of RS-485 communication. Factory setting Built-in controller type: 0 Pulse input type with RS-485 communication interface: 1

Name		Display	Description
15	Transmission rate setting switch	BAUD	Use this switch when controlling the system via RS-485 communication. Sets the transmission rate of RS-485 communication. Factory setting Built-in controller type: 7 Pulse input type with RS-485 communication interface: 4
16	Function setting switch	SW1	Use this switch when controlling the system via RS-485 communication. <ul style="list-style-type: none"> No.1: Using this switch and the address number setting switch (ID), set the address number of RS-485 communication. Factory setting: OFF No.2: Sets the protocol of RS-485 communication. Factory setting Built-in controller type: OFF Pulse input type with RS-485 communication interface: ON
17	HOME PRESET switch	HOME PRESET	This switch is used to set the starting position (home) when performing positioning operation.
20	Termination resistor setting switch	TERM.	Use this switch when controlling the system via RS-485 communication. Sets the termination resistor (120 Ω) of RS-485 communication. Factory setting Both No.1 and No.2 are OFF

● Pulse input type

Name		Display	Description
8	CHARGE LED (Red)	CHARGE	This LED is lit while the main power is input. After the main power was turned off, the LED will turn off once the residual voltage in the driver drops to a safe level.
12	PWR/ALM LED (Green/Red)	PWR/ALM	<ul style="list-style-type: none"> This LED is lit in green while the control power supply is input. If an alarm (protective function) generates, the LED will blink in red. If the power removal function is triggered, the LED will blink in green. If information generates, the LED will blink in red and green simultaneously. (Red and green colors may overlap and it may be visible to orange.)
13	READY LED (Green)	READY	This LED is lit while the READY output is ON. It is not lit when the READY output is OFF.
14	Current setting switch	CURRENT	This switch is used to set the base current rate for the operating current and standstill current. Factory setting: F
15	Command filter setting switch	FIL	This switch adjusts the motor response. Factory setting: 1
16	Function setting switch	SW1	<ul style="list-style-type: none"> No.1: This switch is used to set the resolution per revolution of the motor output shaft. Factory setting: OFF (1,000 P/R) No.2: This switch is used to toggle between the 1-pulse input mode and 2-pulse input mode. The factory setting of the pulse-input mode depends on the destination country.
17	HOME PRESET switch	HOME PRESET	This switch is used to set the starting position (home) when performing positioning operation.

6 Installation

This chapter explains the installation location and installation method of the driver.

6-1 Installation location

The driver is designed and manufactured to be incorporated in equipment. Install it in a well-ventilated location that provides easy access for inspection.

The location must also satisfy the following conditions:

- Inside an enclosure that is installed indoors (provide vent holes)
- Operating ambient temperature 0 to +55 °C (+32 to +131 °F) (non-freezing)
- Operating ambient humidity 85 % or less (non-condensing)
- Area free of explosive atmosphere or toxic gas (such as sulfuric gas) or liquid
- Area not exposed to direct sun
- Area free of excessive amount of dust, iron particles or the like
- Area not subject to splashing water (rain, water droplets), oil (oil droplets) or other liquids
- Area free of excessive salt
- Area not subject to continuous vibrations or excessive shocks
- Area free of excessive electromagnetic noise (from welders, power machinery, etc.)
- Area free of radioactive materials, magnetic fields or vacuum
- 1,000 m (3,300 ft.) or lower above sea level

6-2 Installation method

The driver is designed so that heat is dissipated via air convection and conduction through the enclosure. Install the driver on a flat metal plate (*) having excellent heat conductivity.

There must be a clearance of at least 25 mm (0.98 in.) in the horizontal and vertical directions, between the driver and enclosure or other equipment within the enclosure.

When installing the driver inside an enclosure, use two screws (M4, not included) to secure the driver through the mounting holes.

Material: aluminum, 200×200×2 mm equivalent (7.87×7.87×0.08 in.)



- Install the driver inside an enclosure whose pollution degree is 2 or better environment, or whose degree of protection is IP54 minimum.
- Do not install any equipment that generates a large amount of heat or noise near the driver.
- Do not install the driver underneath the controller or other equipment vulnerable to heat.
- If the ambient temperature of the driver exceeds 55 °C (131 °F), reconsider the ventilation condition.
- Be sure to install the driver vertically (vertical position).

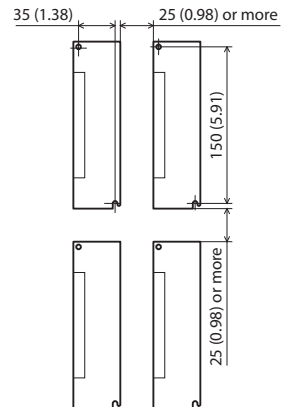

Unit: mm (in.)

Dimension [unit: mm (in.)]

The dimension is common to all drivers.

Mass: 0.65 kg (1.43 lb)

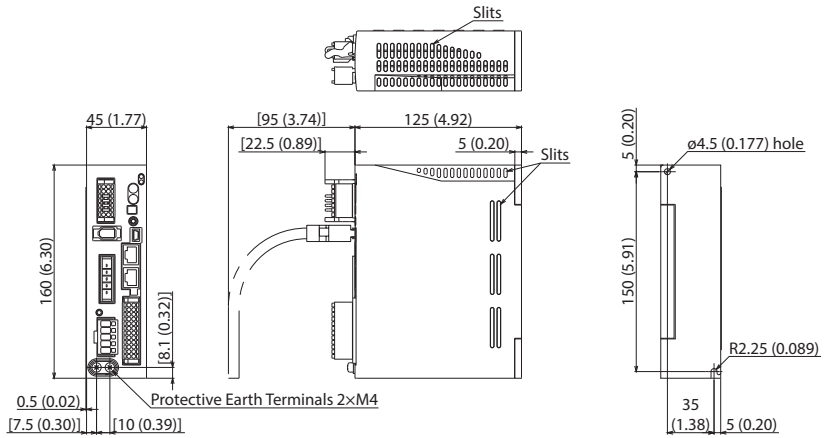

7 Connection

This chapter explains how to connect the motor, power supply and I/O signals to the driver, as well as grounding method.

⚠ WARNING

- For protection against electric shock, do not turn on the main power supply and control power supply until the wiring is completed.
- A high voltage is applied to the motor connector (CN3) and the main power supply input terminals (CN4). Do not touch these terminals while the power is on. Doing so may result in fire or electric shock.

7-1 Connection example

The figure shows models for the electromagnetic brake type and single-phase 200 to 240 VAC input.

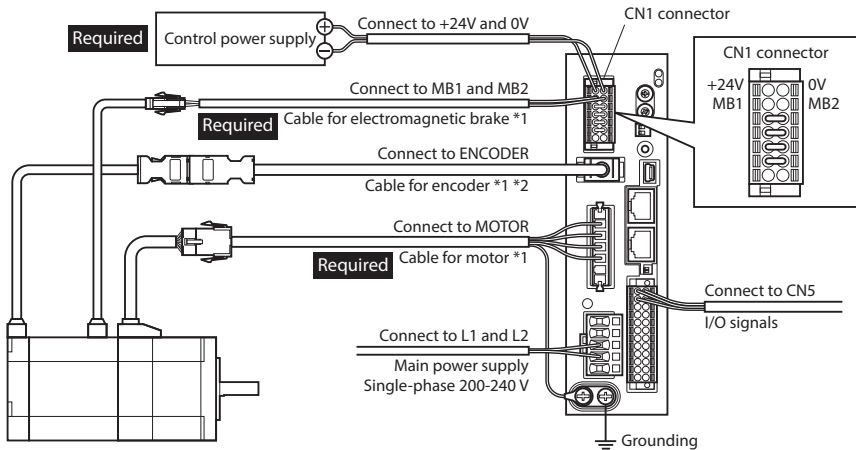

*1 This cable is provided as our product. Purchase it separately.

*2 Use the cable for encoder when the length of the encoder cable of motor is not enough.

Note

- Connect the connectors securely. Insecure connections may cause malfunction or damage to the motor or driver.
- When connecting or disconnecting the connector, turn off the main power supply and control power supply, and wait for the CHARGE LED to turn off before doing so. The residual voltage may cause electric shock.
- Do not wire the power supply cable of the driver in the same cable duct with other power lines or motor cables. Doing so may cause malfunction due to noise.
- The lead wires of the "cable for electromagnetic brake" have polarities, so connect them in the correct polarities. If the lead wires are connected with their polarities reversed, the electromagnetic brake will not operate properly.
- Keep 20 m (65.6 ft.) or less for the wiring distance between the motor and driver. To extend more than 20 m (65.6 ft.) may result in the driver heat generation or increase of the electrical noise emitted from the product.

memo

- The control power supply is required with or without an electromagnetic brake. Be sure to connect it.
- When disconnecting the motor cable, pull out while pressing the latches on the connector.
- When installing the motor on a moving part, use our flexible cable having excellent flex resistance.

7-2 Connecting to CN1

■ Wiring the CN1 connector

- Applicable lead wire: AWG24 to 16 (0.2 to 1.25 mm²)
- Stripping length of wire insulation: 10 mm (0.39 in.)

1. Strip the insulation cover of the lead wire.
2. Insert the lead wire while pushing the button of the orange color with a slotted screwdriver.
3. After having inserted, release the button to secure the lead wire.

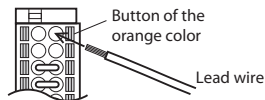

■ Pin assignment list

There are terminals of 0V for control power supply and for internal connection. Check each position in the figure and table below.

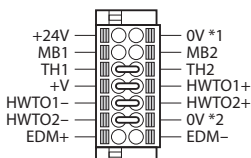

Display	Description
+24V, 0V *1	Connects the control power supply. • When the electromagnetic brake is not used: 24 VDC±5 % 0.25 A • When the electromagnetic brake is used: 24 VDC±5 % 0.5 A (0.33 A for AZM46) • When the electromagnetic brake is used and the distance between the motor and driver is 20 m (65.6 ft.): 24 VDC±4 % 0.5 A (0.33 A for AZM46)
MB1, MB2	Connects the lead wires from the electromagnetic brake. MB1: Electromagnetic brake- (Black) MB2: Electromagnetic brake+ (White)
TH1, TH2	Connects the thermostat outputs of our regeneration resistor. If the regeneration resistor is not used, connect a jumper wire between the terminals as shown in the figure.
HWTO1+, HWTO1- HWTO2+, HWTO2-	Connects the external device. If the power removal function is not used, connect a jumper wire between the terminals as shown in the figure.
EDM+, EDM-	Connects the external device. If the power removal function is not used, do not connect anything.
+V, 0V *2	For internal connections. Do not connect anything. If the power removal function is not used, connect a jumper wire between the terminals as shown in the figure.



For details about power removal function, refer to the OPERATING MANUAL AZ Series Function Edition.

7-3 Connecting the regeneration resistor

Connect our regeneration resistor if gravitational operation or other operations involving up/down movement, or sudden starting/stopping of a large inertial load, will be repeated frequently.

- The two thin lead wires (AWG22: 0.3 mm²) of the regeneration resistor are the thermostat outputs. Connect them to the TH1 and TH2 using the CN1 connector.
- Regenerative current flows through the two thick lead wires (AWG18: 0.75 mm²) of the regeneration resistor. Connect them to the RG1 and RG2 using the CN4 connector.

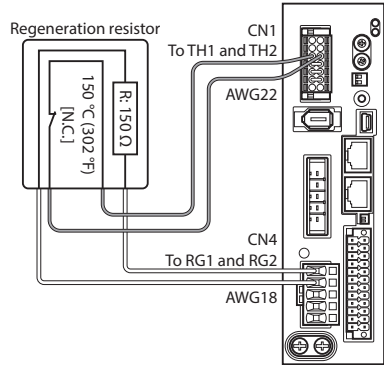

- Before connecting the regeneration resistor, be sure to remove the jumper wire from the CN1 connector.
- If the allowable power consumption of the regeneration resistor exceeds the allowable level, the thermostat will be triggered and the regeneration resistor overheat alarm of the driver will generate. If the regeneration resistor overheat alarm generates, turn off the main power supply and control power supply, and check the connection or operating condition.

Regeneration resistor specification

Model	RGB100
Allowable current consumption	Continuous regenerative power: 50 W * Instantaneous regenerative power: 600 W
Resistance value	150 Ω
Thermostat operating temperature	Operation: Opens at 150±7 °C (302±12.6 °F) Reset: Closes at 145±12 °C (293±21.6 °F) [normally closed]
Thermostat electrical rating	120 VAC 4 A, 30 VDC 4 A (minimum current: 5 mA)

* Install the regeneration resistor in a location where heat dissipation capacity equivalent to a level achieved with a heat sink [made of aluminum, 350×350×3 mm (13.78×13.78×0.12 in.)] is ensured.

7-4 Connecting the main power supply

The connecting method varies depending on the power supply specification of the driver.

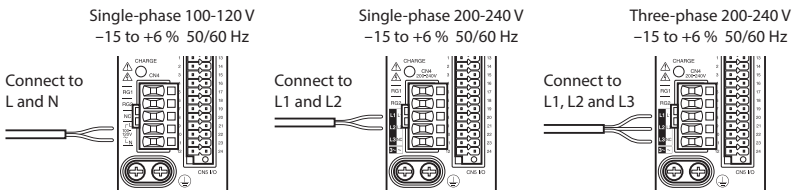

■ Wiring the CN4 connector

- Applicable lead wire: AWG18 to 14 (0.75 to 2.0 mm²)
- Stripping length of wire insulation: 9 mm (0.35 in.)

1. Insert the connector lever.
2. Insert the lead wire while pushing down the connector lever.

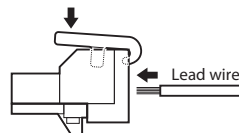

■ Power supply current capacity

The current capacity of the main power supply varies depending on the product combined.

Check the current capacity in reference to the equipped motor model name when using the **EAC** Series, **EAS** Series, **EZS** Series, or **EZSH** Series.

● Single-phase 100-120 VAC

Model	Power supply current capacity
AZM46	2.7 A or more
AZM48	2.7 A or more
AZM66	3.8 A or more
AZM69	5.4 A or more
AZM98	5.5 A or more
AZM911	6.4 A or more
DGB85	2.7 A or more
DGB130	3.8 A or more
DGM85	2.7 A or more
DGM130	3.8 A or more
DGM200	6.4 A or more
LM2	3.8 A or more
LM4	3.8 A or more

● Single-phase 200-240 VAC

Model	Power supply current capacity
AZM46	1.7 A or more
AZM48	1.6 A or more
AZM66	2.3 A or more
AZM69	3.3 A or more
AZM98	3.3 A or more
AZM911	3.9 A or more
DGB85	1.7 A or more
DGB130	2.3 A or more
DGM85	1.7 A or more
DGM130	2.3 A or more
DGM200	3.9 A or more
LM2	2.3 A or more
LM4	2.3 A or more

● Three-phase 200-240 VAC

Model	Power supply current capacity
AZM46	1.0 A or more
AZM48	1.0 A or more
AZM66	1.4 A or more
AZM69	2.0 A or more
AZM98	2.0 A or more
AZM911	2.3 A or more
DGB85	1.0 A or more
DGB130	1.4 A or more
DGM85	1.0 A or more
DGM130	1.4 A or more
DGM200	2.3 A or more
LM2	1.4 A or more
LM4	1.4 A or more

7-5 Grounding

Two Protective Earth Terminals (screw size: M4) are provided on the driver. Be sure to ground one of the Protective Earth Terminals. You can ground either of the two Protective Earth Terminals.

Grounding wire: AWG16 to 14 (1.25 to 2.0 mm²)

Tightening torque: 1.2 N·m (170 oz-in)

Connect the grounding wire of the "cable for motor" to the other terminal to ground the motor.

Do not share the grounding wire with a welder or any other power equipment.

When grounding the Protective Earth Terminal, use a round terminal and secure the grounding point near the driver.

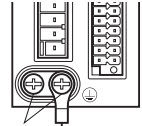

Protective Earth Terminals
(Ground one of these terminals.)

7-6 Connecting the I/O signals

■ Wiring the CNS connector

- Applicable lead wire: AWG24 to 16 (0.2 to 1.25 mm²)
- Stripping length of wire insulation: 10 mm (0.39 in.)

1. Strip the insulation cover of the lead wire.
2. Insert the lead wire while pushing the button of the orange color with a slotted screwdriver.
3. After having inserted, release the button to secure the lead wire.

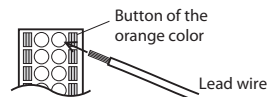

Be certain the I/O signal cable is as short as possible. The maximum input frequency will decrease as the cable length increases.

■ Pin assignment list

● Built-in controller type

Pin No.	Signal name	Description *
1	IN0	Control input 0 (START)
2	IN2	Control input 2 (M1)
3	IN4	Control input 4 (ZHOME)
4	IN6	Control input 6 (STOP)
5	IN-COM [0-7]	IN0 to IN7 input common
6	IN8	Control input 8 (FW-JOG)
7	OUT0	Control output 0 (HOME-END)
8	OUT2	Control output 2 (PLS-RDY)
9	OUT4	Control output 4 (MOVE)
10	OUT-COM	Output common
11	ASG+	A-phase pulse output+
12	BSG+	B-phase pulse output+

* (): Initial value

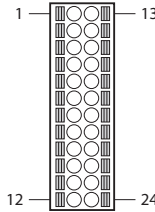

Pin No.	Signal name	Description *
13	IN1	Control input 1 (M0)
14	IN3	Control input 3 (M2)
15	IN5	Control input 5 (FREE)
16	IN7	Control input 7 (ALM-RST)
17	IN-COM [8-9]	IN8, IN9 input common
18	IN9	Control input 9 (RV-JOG)
19	OUT1	Control output 1 (IN-POS)
20	OUT3	Control output 3 (READY)
21	OUT5	Control output 5 (ALM-B)
22	GND	Ground
23	ASG-	A-phase pulse output-
24	BSG-	B-phase pulse output-

* (): Initial value

● Pulse input type with RS-485 communication interface, pulse input type

Pin No.	Signal name	Description *
1	CW+ [PLS+]	CW pulse input+ [Pulse input+]
2	CCW+ [DIR+]	CCW pulse input+ [Direction input +]
3	IN4	Control input 4 (ZHOME)
4	IN6	Control input 6 (STOP)
5	IN-COM [4-7]	IN4 to IN7 input common
6	IN8	Control input 8 (FW-JOG)
7	OUT0	Control output 0 (HOME-END)
8	OUT2	Control output 2 (PLS-RDY)
9	OUT4	Control output 4 (MOVE)
10	OUT-COM	Output common
11	ASG+	A-phase pulse output+
12	BSG+	B-phase pulse output+

* (): Initial value

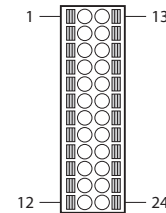

Pin No.	Signal name	Description *
13	CW- [PLS-]	CW pulse input- [Pulse input-]
14	CCW- [DIR-]	CCW pulse input- [Direction input-]
15	IN5	Control input 5 (FREE)
16	IN7	Control input 7 (ALM-RST)
17	IN-COM [8-9]	IN8, IN9 input common
18	IN9	Control input 9 (RV-JOG)
19	OUT1	Control output 1 (IN-POS)
20	OUT3	Control output 3 (READY)
21	OUT5	Control output 5 (ALM-B)
22	GND	Ground
23	ASG-	A-phase pulse output-
24	BSG-	B-phase pulse output-

* (): Initial value

7-7 Connection diagram

■ Connecting to a current sink output circuit

The figure shows a connection example of the built-in controller type driver. In the case of the pulse input type with RS-485 communication interface and the pulse input type, the pin No.1, No.2, No.13, and No.14 are only available to the pulse input. Refer to p.21 for connection example.

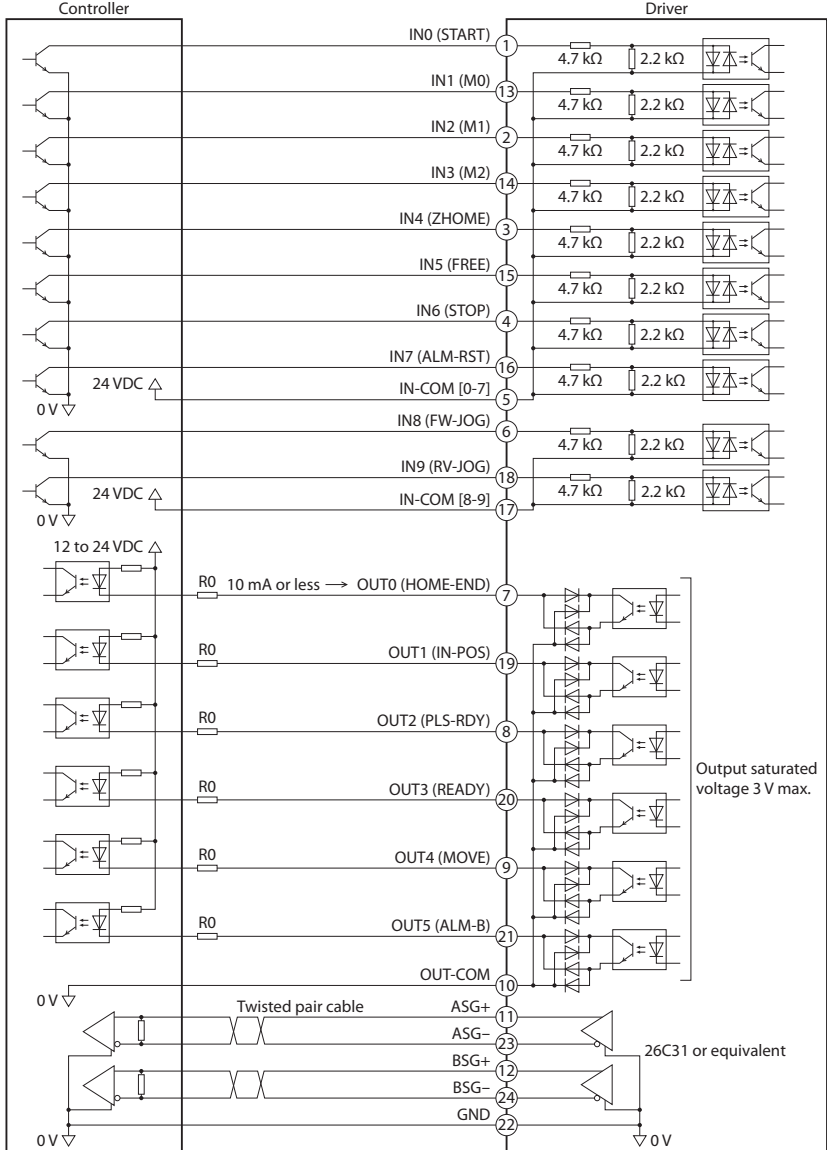

* (): Initial value



- Use input signals at 24 VDC.
- Use output signals at 12 to 24 VDC, 10 mA or less. If the current exceeds 10 mA, connect an external resistor R0 so that the current becomes 10 mA or less.
- The saturated voltage of the output signal is 3 VDC maximum.

● **Pulse input type with RS-485 communication interface, pulse input type**

The pin No.1, No.2, No.13, and No.14 are only available to the pulse input. Other functions cannot be assigned.

When pulse input is of line driver type

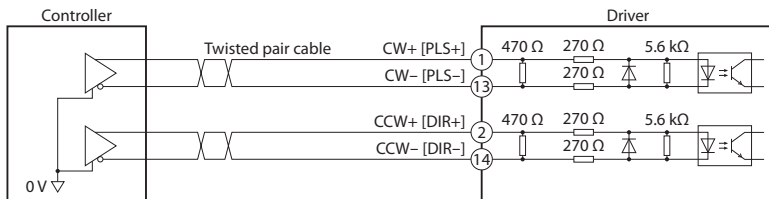

When pulse input is of open-collector type (When using the voltage of pulse input signals at 5 VDC)

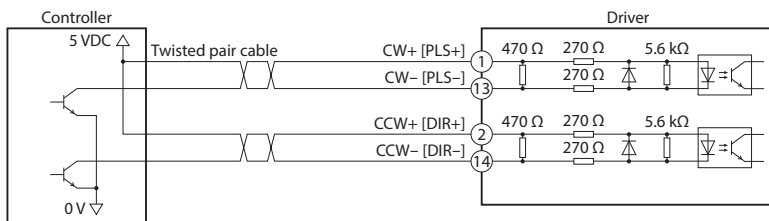

When pulse input is of open-collector type (When using the voltage of pulse input signals at 24 VDC)

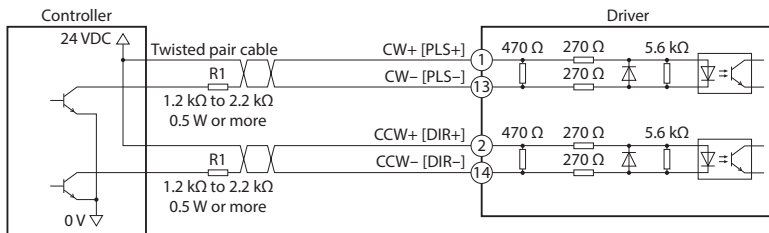

Use the CW [PLS] input and CCW [DIR] input at 5 VDC to 24 VDC. When using signals at 24 VDC, connect an external resistor R1 (1.2 kΩ to 2.2 kΩ, 0.5 W or more). When using signals at 5 VDC, apply the voltage directly.

■ Connecting to a current source output circuit

The figure shows a connection example of the built-in controller type driver. In the case of the pulse input type with RS-485 communication interface and the pulse input type, the pin No.1, No.2, No.13, and No.14 are only available to the pulse input. Refer to p.23 for connection example.

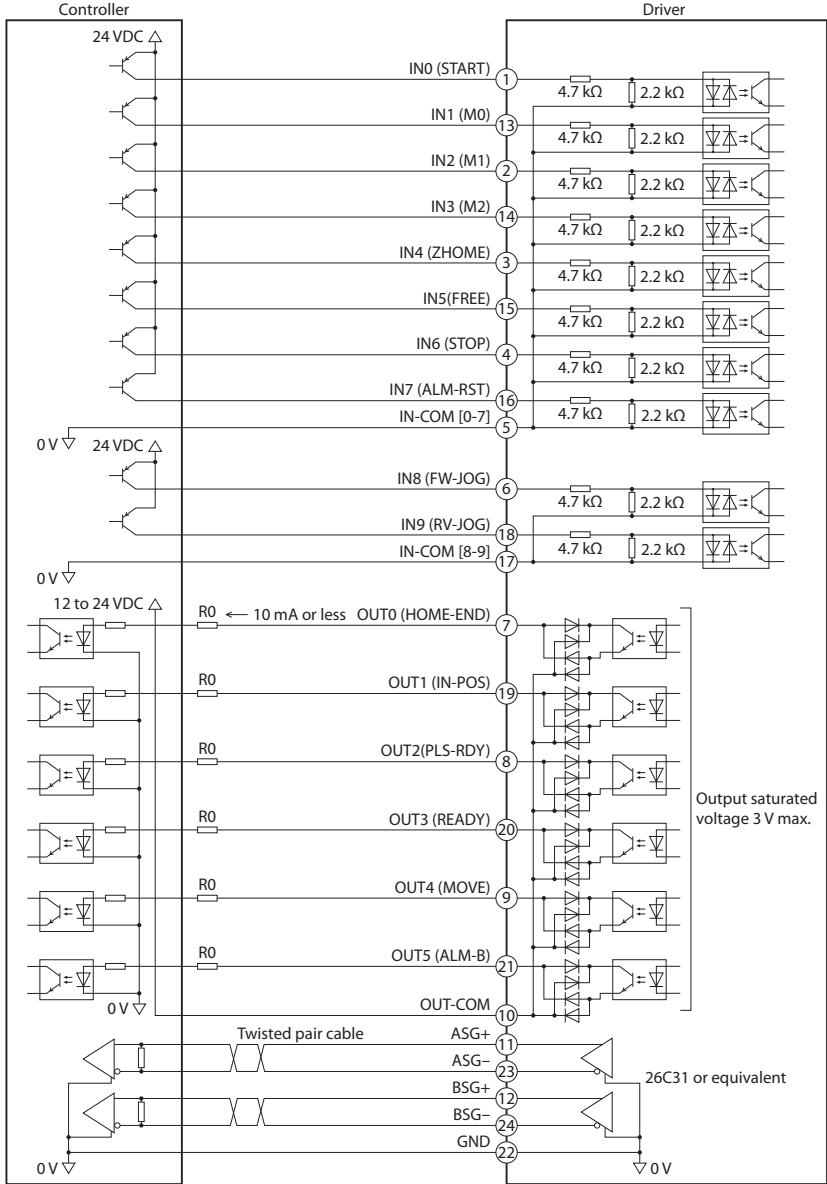

*(): Initial value



- Use input signals at 24 VDC.
- Use output signals at 12 to 24 VDC, 10 mA or less. If the current exceeds 10 mA, connect an external resistor R0 so that the current becomes 10 mA or less.
- The saturated voltage of the output signal is 3 VDC maximum.

● **Pulse input type with RS-485 communication interface, pulse input type**

The pin No.1, No.2, No.13, and No.14 are only available to the pulse input. Other functions cannot be assigned.

When pulse input is of line driver type

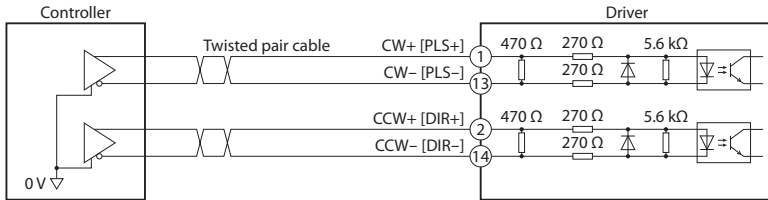

When pulse input is of open-collector type (When using the voltage of pulse input signals at 5 VDC)

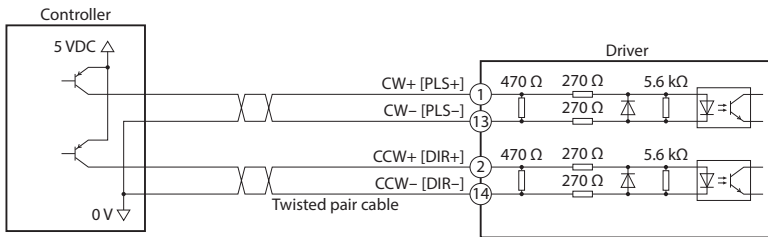

When pulse input is of open-collector type (When using the voltage of pulse input signals at 24 VDC)

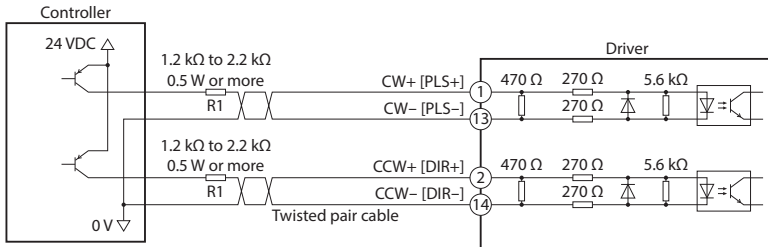

Use the CW [PLS] input and CCW [DIR] input at 5 VDC to 24 VDC. When using signals at 24 VDC, connect an external resistor R1 (1.2 kΩ to 2.2 kΩ, 0.5 W or more). When using signals at 5 VDC, apply the voltage directly.

7-8 Connecting the RS-485 communication cable

Connect this cable if you want to control your product via RS-485 communication. Connect the RS-485 communication cable to CN6 or CN7 on the driver. You can use the vacant connectors to connect a different driver.

A driver link cable is provided as our product. Refer to p.55 for the model name.

A commercially-available LAN cable (straight cable) can also be used to link drivers.

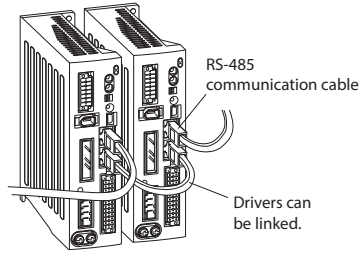

Pin assignment list

Pin No.	Signal name	Description
1	N.C.	Not used
2	GND	GND
3	TR+	RS-485 communication signal (+)
4	N.C.	Not used
5	N.C.	
6	TR-	RS-485 communication signal (-)
7	N.C.	Not used
8	N.C.	

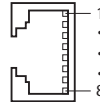

Internal input circuit

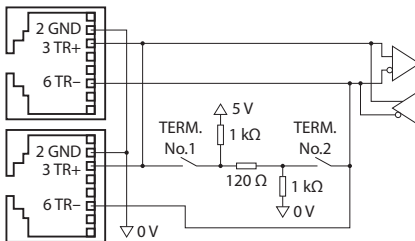

7-9 Connecting the USB cable

Using a USB cable of the following specification, connect a PC in which the **MEXE02** has been installed to the USB communication connector.

Specification	USB2.0 (Full Speed)
Cable	Length: 3 m (9.8 ft.) or less Type: A to mini B



- Connect the driver and PC directly using the USB cable.
- In large electrically noisy environments, use the USB cable with a ferrite core or install a ferrite core to the USB cable.

7-10 Noise elimination measures

There are two types of electrical noises: One is a noise to invade into the driver from the outside and cause the driver malfunction, and the other is a noise to emit from the driver and cause peripheral equipment malfunction.

For the noise that is invaded from the outside, take measures to prevent the driver malfunction. It is needed to take adequate measures because signal lines are very likely to be affected by the noise.

For the noise that is emitted from the driver, take measures to suppress it.

■ Measures against electrical noise

There are the following three methods mainly to take measures against the electrical noise.

● Noise suppression

- When relays or electromagnetic switches are used together with the system, use noise filters and CR circuits to suppress surges generated by them.
- Use our connection cable when extending a wiring distance between the motor and driver. This is effective in suppressing the electrical noise emitted from the motor.
- Cover the driver by a metal plate such as aluminum. This is effective in shielding the electrical noise emitted from the driver.

● Prevention of noise propagation

- Connect a noise filter in the power supply cable of driver.
- Place the power lines, such as the motor and power supply cables, keeping a distance of 200 mm (7.87 in.) or more from the signal lines, and also do not bundle them or wire them in parallel. If the power cables and signal cables have to cross, cross them at a right angle.
- Use shielded twisted pair cables for power lines and signal lines.
- Keep cables as short as possible without coiling and bundling extra lengths.
- Grounding multiple points will increase effect to block electrical noise because impedance on the grounding points is decreased. However, ground them so that a potential difference does not occur among the grounding points. I/O signal cable including with a ground wire is also provided as our product. Refer to p.55 for the model name.
- To ground a shielded cable, use a metal cable clamp that will maintain contact with the entire circumference of the cable. Ground the cable clamp near the product.

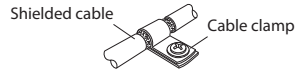

● Suppression of effect by noise propagation

- Loop the noise propagated cable around a ferrite core. Doing so will prevent the propagated noise invades into the driver or emits from the driver. The frequency band in which an effect by the ferrite core can be seen is generally 1 MHz or more. Check the frequency characteristics of the ferrite core used. When increasing the effect of noise attenuation by the ferrite core, loop the cable a lot.
- Use the line driver type, which is less likely to be affected by electrical noise, for the output circuit of pulse signals. When the pulse signal of the controller is the open collector type, use our pulse signal converter for noise immunity. Refer to p.55 for the model name.

■ Noise suppression product

● Noise filter

- Connect the following noise filter (or equivalent) to the power line. Doing so will prevent the propagated noise through the power line. Install the noise filter as close to the driver as possible.

Manufacture	Single-phase 100-120 V Single-phase 200-240 V	Three-phase 200-240 V
SOSHIN ELECTRIC CO., LTD.	HF2010A-UPF	HF3010C-SZA
Schaffner EMC	FN2070-10-06	FN3025HP-10-71

- Use the AWG18 (0.75 mm²) or thicker wire for the input and output cables of the noise filter, and secure firmly using a cable clamp or others so that the cable does not come off the enclosure.
- Place the input cable as far apart as possible from the output cable, and do not wire the cables in parallel. If the input and output cable are placed at a close distance or if they are wired in parallel, the noise in the enclosure affects the power cable through stray capacitance, and the noise suppressing effect will reduce.
- Connect the ground terminal of the noise filter to the grounding point, using as thick and short a wire as possible.
- When connecting a noise filter inside an enclosure, wire the input cable of the noise filter as short as possible. Wiring in long distance may reduce the noise suppressing effect.

■ Our noise suppression products

Refer to p.55 for the model name.

● I/O signal cable

This cable is a shielded cable for good noise immunity to connect the driver and controller. The ground wires useful for grounding are provided at both ends of the cable. The EMC measures are conducted using our I/O signal cable.

● Pulse signal converter for noise immunity

This product converts a pulse signal, which is output from the open collector output, to a pulse signal for good noise immunity by outputting the pulse signal again from the differential output.

● Surge suppressor

This product is effective to suppress the surge which occurs in a relay contact part. Connect it when using a relay or electromagnetic switch. CR circuit for surge suppression and CR circuit module are provided.

7-11 Installing and wiring in compliance with EMC Directive

Effective measures must be taken against the EMI that the motor and driver may give to adjacent control-system equipment, as well as the EMS of the motor and driver itself, in order to prevent a serious functional impediment in the machinery. The use of the following installation and wiring methods will enable the motor and driver to be compliant with the EMC directive. Refer to p.8 for the applicable standards.

Oriental Motor conducts EMC measurements on its motors and drivers in accordance with "Example of motor and driver installation and wiring" on p.27. The user is responsible for ensuring the machine's compliance with the EMC Directive, based on the installation and wiring explained below.

● Connecting the noise filter

In large electrically noisy environments, connect a noise filter. Refer to "Noise filter" on p.25 for details.

● Connecting the control power supply

For the control power supply, use a DC power supply that conforms to the EMC Directive.

Use a shielded cable for the wiring, and keep it as short as possible.

Refer to "Prevention of noise propagation" on p.25 for grounding the shielded cable.

● Connecting the motor cable

Use our connection cable when extending the wiring distance between the motor and driver.

● Connecting the signal cable

Refer to "Prevention of noise propagation" on p.25.

● How to ground

- The cable used to ground the motor, driver and noise filter must be as thick and short as possible so that no potential difference is generated.
- Choose a large, thick and uniformly conductive surface for the grounding point.
- Be sure to ground the Protective Earth Terminals of the motor and driver. Refer to p.18 for grounding method.

● Example of motor and driver installation and wiring



The driver uses parts that are sensitive to electrostatic charge. Take measures against static electricity since static electricity may cause the driver to malfunction or suffer damage.

Built-in controller type, pulse input type with RS-485 communication interface

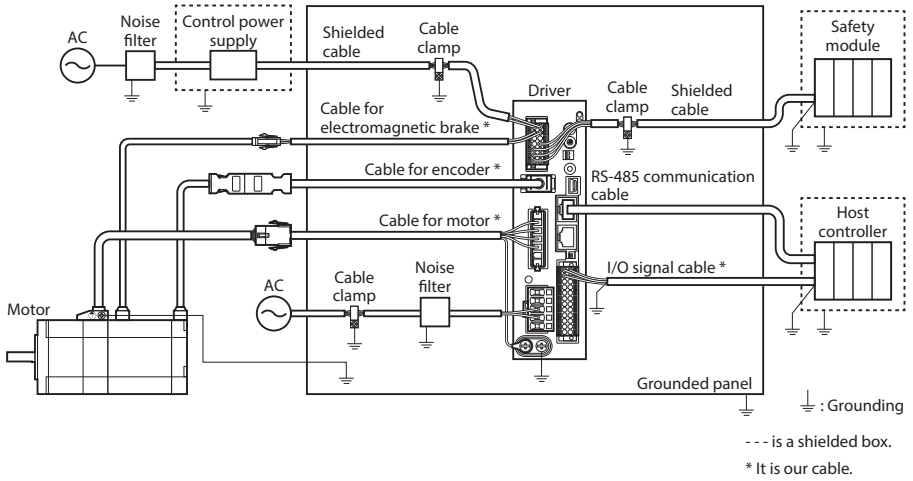

Pulse input type

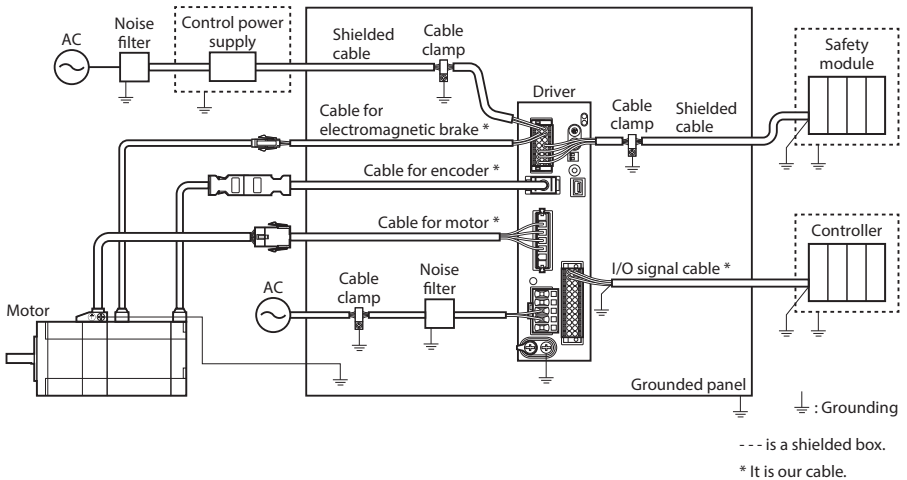

8 Explanation of I/O signals

8-1 Input signals

The following input signals of the driver are photocoupler inputs. The signal state represents the "ON: Carrying current" or "OFF: Not carrying current" state of the internal photocoupler rather than the voltage level of the signal.

■ CW [PLS] input, CCW [DIR] input

These signals are used when the motor is operated by inputting pulses.

These inputs serve as the CW and CCW inputs in the 2-pulse input mode, or PLS and DIR inputs in the 1-pulse input mode. Set the pulse input mode of the driver according to the pulse output mode of the controller (pulse generator) used with the driver. When inputting the pulse, check the PLS-RDY output is turned ON.

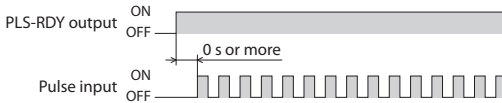

memo When the motor is at standstill, be sure to keep the photocoupler in OFF state.

● Maximum input pulse frequency

- When the controller is of line driver type: 1 MHz (duty cycle is 50 %)
- When the controller is of open-collector type: 250 kHz (duty cycle is 50 %)

● 2-pulse input mode

When the CW input is turned from OFF to ON, the motor will rotate by one step in CW direction.
When the CCW input is turned from OFF to ON, the motor will rotate by one step in CCW direction.

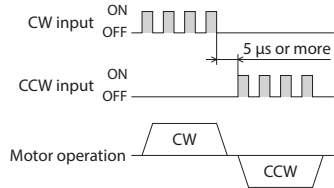

Note Do not input the CW signal and CCW signal simultaneously. If the other signal is input while one of the signals is ON, the motor cannot operate normally.

● 1-pulse input mode

When the PLS input is turned from OFF to ON while the DIR input is ON, the motor will rotate by one step in CW direction.
When the PLS input is turned from OFF to ON while the DIR input is OFF, the motor will rotate by one step in CCW direction.

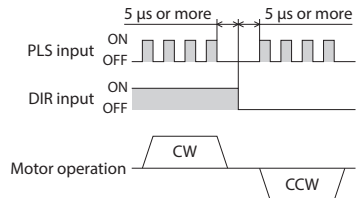

■ START input

This signal is used to start positioning operation. It is not used when the motor is operated by inputting pulses. Select the operation data number and turn the START input ON to start positioning operation.

■ M0, M1, M2 input

Select a desired operation data number based on a combination of ON/OFF status of the M0 to M2 inputs.

Operation data No.	M2	M1	M0
0	OFF	OFF	OFF
1	OFF	OFF	ON
2	OFF	ON	OFF
3	OFF	ON	ON
4	ON	OFF	OFF
5	ON	OFF	ON
6	ON	ON	OFF
7	ON	ON	ON

■ ZHOME input

When the ZHOME input is turned ON, the motor will move to the home set by the HOME PRESET switch or **MEXE02**. Since it does not require sensors, return-to-home is possible at high-speed.

■ FREE input

When the FREE input is turned ON, the motor current will be cut off. When an electromagnetic brake motor is used, the electromagnetic brake will be released. The motor output shaft can be rotated manually since the motor holding torque is lost.

Note Do not turn the FREE input ON when driving a vertical load. Since the motor loses its holding torque, the load may drop.

■ STOP input

When the STOP input is turned ON, the motor will stop. When resuming the operation, input the operation start signal or pulse to the driver after turning the STOP input OFF.

Note When the motor was stopped by the STOP input while the motor is operated by inputting pulses, be sure to turn the pulse input OFF. If the STOP input is turned OFF while inputting pulses, the motor may suddenly start rotating.

memo If the STOP input is turned ON while the motor is operated by inputting pulses, the driver is not allowed to receive the pulse input.

■ ALM-RST input

If the ALM-RST input is turned from OFF to ON while an alarm is generated, the alarm will be reset. (The alarm will be reset at the ON edge of the ALM-RST input.) Before resetting an alarm, be sure to remove the cause of the alarm to ensure safety. Note that some alarms cannot be reset with the ALM-RST input.

memo When the motor is operated by inputting pulses, turn the pulse input OFF before resetting the alarm.

■ FW-JOG input, RV-JOG input

These signals are used to start JOG operation.

The motor continuously operates in the forward direction when turning the FW-JOG input ON, and the motor continuously operates in the reverse direction when turning the RV-JOG input ON. If the signal having inputted is turned OFF, the motor will stop.

8-2 Output signals

The driver outputs signals in the photocoupler/open-collector output mode or line driver output mode. The signal state represents the "ON: Carrying current" or "OFF: Not carrying current" state of the internal photocoupler rather than the voltage level of the signal.

HOME-END output

When the home is set or when high-speed return-to-home operation is complete, the HOME-END output turns ON.

IN-POS output

After completion of positioning operation, when the motor was converged in a position of the "IN-POS positioning completion signal range" parameter against the command position, the IN-POS output is turned ON.

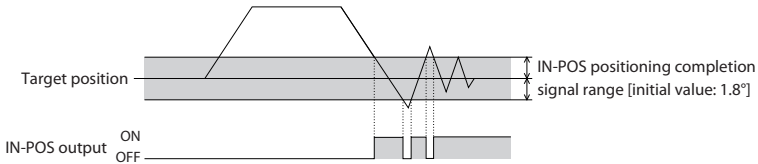

PLS-RDY output

This signal is used when the motor is operated by inputting pulses.

When the driver is ready to execute operation by inputting pulses, the PLS-RDY output turns ON. Input the pulse to the driver after the PLS-RDY output was turned ON.

READY output

When the driver is ready to execute operation, the READY output turns ON. Input the operation start signal to the driver after the READY output was turned ON.

MOVE output

The MOVE output turns ON while the motor is operating.

ALM-B output

When an alarm generates, the ALM-B output will turn OFF, and the motor will stop. At the same time, the PWR/ALM LED on the driver will blink in red. The ALM-B output is normally closed.

ASG output, BSG output

The ASG output is used to output pulses according to motor operation. The motor position can be monitored by counting the ASG output pulses. The number of output pulses per motor revolution varies depending on the resolution effective when turning the control power supply on.

The BSG output has a 90° phase difference with respect to the ASG output. The motor rotation direction can be determined by detecting the BSG output level at the rise of the ASG output.

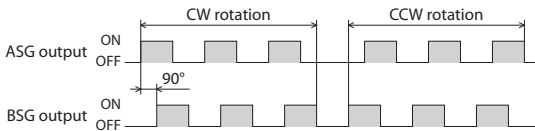

- The ASG output and BSG output are subject to a maximum delay of 0.1 ms with respect to motor operation. Use these outputs to check the position at which the motor is stopped.
- Connect a termination resistor of 100 Ω or more between the driver and the input of the line receiver.

9 Setting

This chapter explains how to set the motor and driver functions.

9-1 Setting of the built-in controller type and pulse input type with RS-485 communication interface

The figure shows the built-in controller type driver.

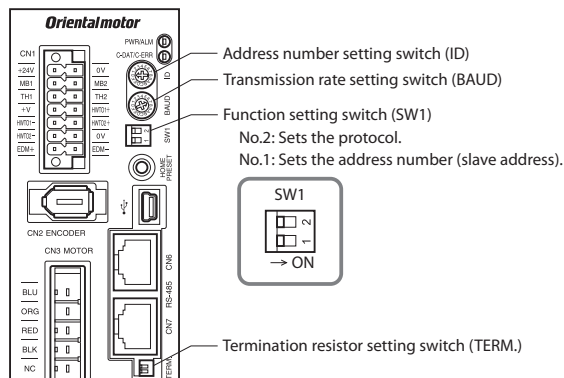

Before setting the function setting switch (SW1), be sure to turn off the main power supply and control power supply, and wait for the CHARGE LED to turn off. The residual voltage may cause electric shock.



The new setting of the SW1 will become effective after the control power supply is turned on.

About resolution

The initial value of resolution of the driver is 1,000 P/R. The initial value of resolution may vary depending on the product connected. Check with the operating manual of the motor or motorized actuator used.

Protocol

Set the protocol of RS-485 communication using the SW1-No.2 of the function setting switch.

Factory setting **Built-in controller type; OFF**
Pulse input type with RS-485 communication interface; ON

SW1-No.2	Protocol
ON	Modbus RTU mode
OFF	Connecting with network converter

■ **Address number (slave address)**

Set the address number (slave address) using the address number setting switch (ID) and SW1-No.1 of the function setting switch. Make sure each address number (slave address) you set for each driver is unique.

Factory setting Built-in controller type; ID: 0, SW1-No.1: OFF
 Pulse input type with RS-485 communication interface; ID: 1, SW1-No.1: OFF

ID	SW1-No.1	Address number (slave address)	ID	SW1-No.1	Address number (slave address)
0	OFF	0 *	0	ON	16
1		1	1		17
2		2	2		18
3		3	3		19
4		4	4		20
5		5	5		21
6		6	6		22
7		7	7		23
8		8	8		24
9		9	9		25
A		10	A		26
B		11	B		27
C		12	C		28
D		13	D		29
E		14	E		30
F		15	F		31

* In the case of Modbus protocol, the address number (slave address) 0 is reserved for broadcasting, so do not use this address.

■ **Transmission rate**

Set the transmission rate using transmission rate setting switch (BAUD). The transmission rate to be set should be the same as the transmission rate of the host controller.

Factory setting Built-in controller type; 7
 Pulse input type with RS-485 communication interface; 4

BAUD	Transmission rate (bps)
0	9,600
1	19,200
2	38,400
3	57,600
4	115,200
5	230,400
6	Not used.
7	Network converter
8 to F	Not used.

 Do not set BAUD to positions 6 and 8 to F.

■ Termination resistor

Set a termination resistor to the driver located farthest away (positioned at the end) from the host controller or network converter.

Turn the termination resistor setting switch (TERM.-No.1 and No.2) ON to set the termination resistor for RS-485 communication (120 Ω).

Factory setting OFF for both No.1 and No.2 (termination resistor disabled)

TERM.-No.1, No.2	Termination resistor (120 Ω)
Both are OFF	Disabled
Both are ON	Enabled



If only one of the two of No.1 and No.2 is turned ON, a communication error may occur.

9-2 Setting of the pulse input type

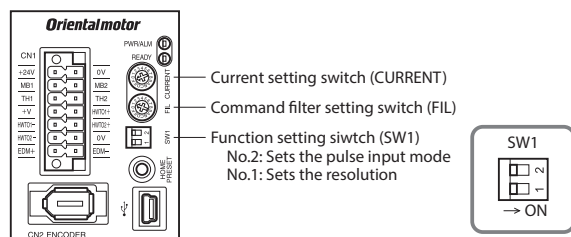

Before setting the function setting switch (SW1), be sure to turn off the main power supply and control power supply, and wait for the CHARGE LED to turn off. The residual voltage may cause electric shock.



The new setting of the SW1 will become effective after the control power supply is turned on.

■ Resolution

Set a resolution per revolution of the motor output shaft using the SW1-No.1 of the function setting switch.

OFF: 1,000 P/R (factory setting)

ON: 10,000 P/R

■ Pulse input mode

Set a pulse input mode of the driver according to the pulse output mode of the controller (pulse generator) used with the driver. Set a desired mode using the SW1-No.2 of the function setting switch. The factory setting of the pulse input mode depends on the destination country.

OFF: 2-pulse input mode

ON: 1-pulse input mode

■ Base current rate

Set the base current rate (%) for the operating current and standstill current using the current setting switch (CURRENT). If the load is small and there is an ample allowance for torque, motor temperature rise can be suppressed by setting a lower base current rate.

The actual operating current and standstill current are as follows.

- Operating current: Maximum output current × Base current rate
- Standstill current: Maximum output current × Base current rate × 0.5

The dial settings and corresponding base current rates are listed below.

Dial setting	Base current rate (%)	Dial setting	Base current rate (%)
0	6.3	8	56.3
1	12.5	9	62.5
2	18.8	A	68.8
3	25.0	B	75.0
4	31.3	C	81.3
5	37.5	D	87.5
6	43.8	E	93.8
7	50.0	F	100 (factory setting)



Excessively low operating current or standstill current may cause a problem in starting the motor or holding the load in position. Set a suitable current for your application.



The motor torque is proportional to the current. If the CURRENT switch is set to "7" (50 %) while the operating torque is set to 100 % (maximum output current), only 50 % of the torque is output.

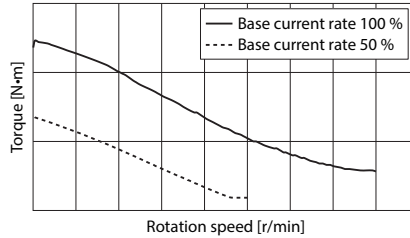

■ Command filter

The motor response to input pulses can be adjusted using the command filter setting switch (FIL).

When setting a higher value for the command filter, lower vibration at low speed operation or smoother operation at starting/stopping of the motor can be achieved. However, if this setting is too high, synchronization performance is decreased. Set a suitable value based on the load or application.

The dial settings and corresponding command filter time constant are listed below.

Dial setting	Command filter time constant (ms)	Dial setting	Command filter time constant (ms)
0	0	8	30
1	1 (factory setting)	9	50
2	2	A	70
3	3	B	100
4	5	C	120
5	7	D	150
6	10	E	170
7	20	F	200

10 Guidance

If you are new to the **AZ Series**, read this section to understand the operating methods along with the operation flow.

■ How to read the guidance

This chapter explains the operation procedure as follows.

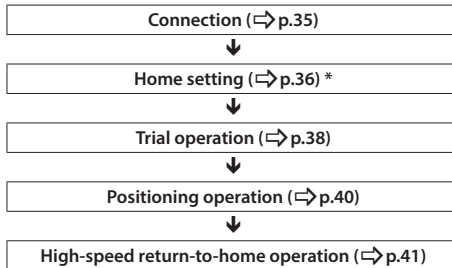

* Perform the home setting only once initially. Once the home is set, it is no need to set afterward.

10-1 Connection

Wire the driver by reference to the figure. Be sure to connect a control power supply.

The following explanation is an example for when the built-in controller type driver of single-phase 200-240 VAC is used.

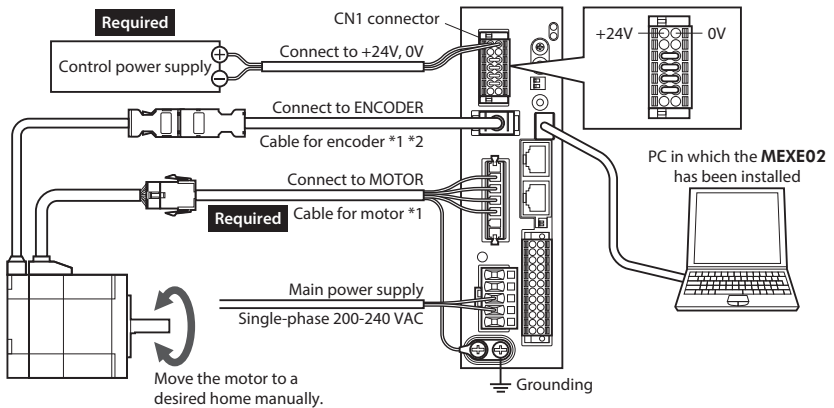

*1 This cable is provided as our product. Purchase it separately.

*2 Use the cable for encoder when the length of the encoder cable of motor is not enough.

10-2 Home setting

The home has not set at the time of shipment. Before starting operation, be sure to set the home. Perform the home setting only once initially. Once the home is set, the driver keeps the home information even if the main power supply and control power supply are shut down.

There are the following two methods for how to set the home. Set the home using either of the methods.

- Set the home using the HOME PRESET switch on the driver.
- Set the home using the **MEXE02**.



- The home is written to the non-volatile memory. The non-volatile memory can be rewritten approximately 100,000 times.
- The home for motorized actuators has been set at the time of shipment. Set the home only when you want to change it.

■ Set the home using the HOME PRESET switch

1. Move the motor output shaft to a desired home manually.
2. Turn on the main power supply and control power supply.
3. Check the main power supply and control power supply were turned ON, keep pressing the HOME PRESET switch for 1 second.
Red color and green color on the PWR/ALM LED blinks simultaneously. (Red and green colors may overlap and it may be visible to orange.)

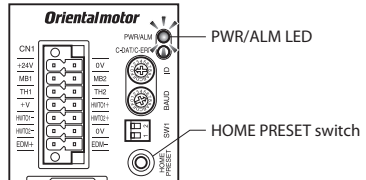

4. Release a hand off within 3 seconds after the PWR/ALM LED started blinking, and press the HOME PRESET switch again within 3 seconds after releasing the hand off.
After both red color and green color on the PWR/ALM LED are lit, only green color continues to be lit.

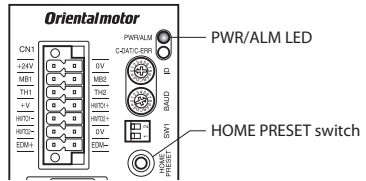

5. The home is set.



About an operation of the procedure 4, be sure to release a hand off after the PWR/ALM LED started blinking, and perform within 3 seconds. If 3 seconds were passed, the PWR/ALM LED will return to the state being lit in green. In this case, perform from the procedure 3 again.

■ Set the home using the MEXE02

1. Turn on the main power supply and control power supply.
2. Start a PC, and continuously start the **MEXE02**.
3. Click the [Teaching, remote operation] icon in the toolbar or click the [Teaching, remote operation] short-cut button.
The teaching, remote operation window appears.



- Click "Start the teaching remote operation."
The pop-up window (Warning) appears, and click [Yes].

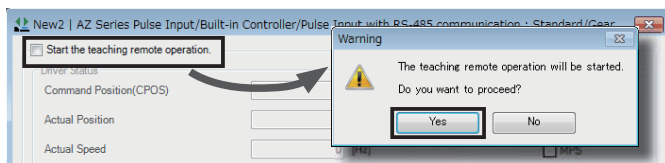

- Since the window which uses to synchronize the **MEXE02** data and the driver data appears, select the synchronization method and click [OK].

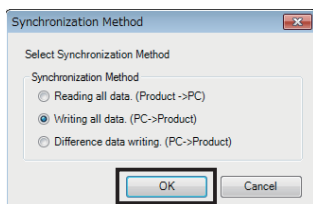

Teaching, remote operation is enabled, and red color and green color on the PWR/ALM LED blink simultaneously. (Red and green colors may overlap and it may be visible to orange.)

- Adjust the motor position using the JOG operation switches.

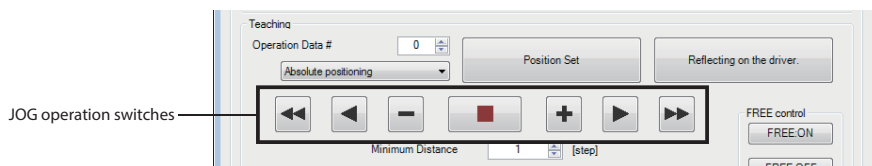

Description of JOG operation switches

Switch	Description
	Performs continuous operation in the negative direction at the operating speed set in the "(JOG Operating speed (high))" parameter.
	Performs continuous operation in the negative direction at the operating speed set in the "(JOG Operating speed)" parameter.
	Performs positioning operation in the negative direction for the travel amount set in the "minimum travel amount" of the JOG operation switches.
	Stops the operation immediately.
	Performs positioning operation in the positive direction for the travel amount set in the "minimum travel amount" of the JOG operation switches.
	Performs continuous operation in the positive direction at the operating speed set in the "(JOG Operating speed)" parameter.
	Performs continuous operation in the positive direction at the operating speed set in the "(JOG Operating speed (high))" parameter.

- When adjusting the motor position manually, click [FREE: ON] first, and click [Yes] on the pop-up window (Warning).
The holding power of the motor output shaft is lost, and the output shaft can be turned by hand. After adjustment, click [FREE: OFF], and put the motor into an excitation state.

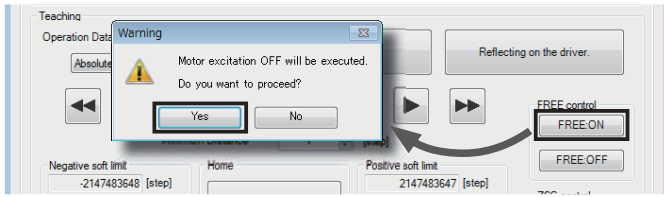

- After setting the motor home, click [Position preset], and click [Yes] on the pop-up window (Warning). The home is set and written to the driver.

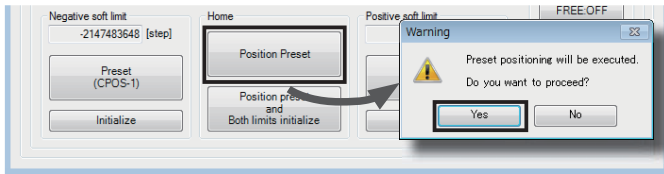

10-3 Trial operation

This section explains an example to perform trial operation using the **MEXE02**.

Note Before operating the motor, check the condition of the surrounding area to ensure safety.

- Click the [Teaching, remote operation] icon in the toolbar or click the [Teaching, remote operation] short-cut button.
The teaching, remote operation window appears.



- Click "Start the teaching remote operation."
The pop-up window (Warning) appears, and click [Yes].

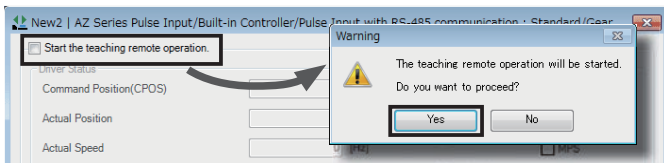





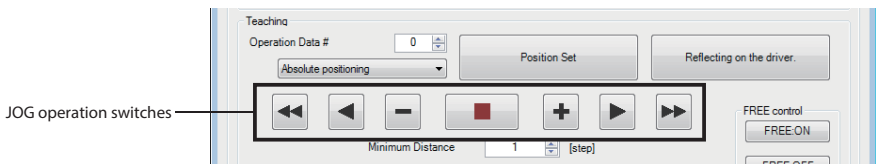

Teaching, remote operation is enabled, and red color and green color on the PWR/ALM LED blink simultaneously. (Red and green colors may overlap and it may be visible to orange.)

- Click the JOG operation switches to perform trial operation of the motor.



Description of JOG operation switches

Switch	Description
	Performs continuous operation in the negative direction at the operating speed set in the "(JOG) Operating speed (high)" parameter.
	Performs continuous operation in the negative direction at the operating speed set in the "(JOG) Operating speed" parameter.
	Performs positioning operation in the negative direction for the travel amount set in the "minimum travel amount" of the JOG operation switches.
	Stops the operation immediately.
	Performs positioning operation in the positive direction for the travel amount set in the "minimum travel amount" of the JOG operation switches.
	Performs continuous operation in the positive direction at the operating speed set in the "(JOG) Operating speed" parameter.
	Performs continuous operation in the positive direction at the operating speed set in the "(JOG) Operating speed (high)" parameter.

If the motor does not operate even when clicking the JOG operation switches, check the following points.

- Are the main power supply and motor connected properly?
- Is an alarm present?

● When changing the operating condition of JOG operation

1. Click on "Motor & mechanism(coordinates/JOG/home operation)" under "Parameter," in the left side of the screen. The "Motor & mechanism" parameter window appears.

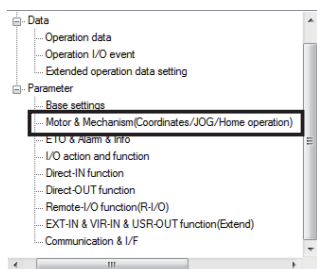

2. Change the "JOG/HOME/ZHOME operation setting" parameter to "Manual setting."
3. Change the operating condition using following five parameters.

Operation data	Motor & Mechanism(Coordinates/JOG/Home operation)	
24	(JOG) Travel amount [step]	1
25	(JOG) Operating speed [Hz]	1000
26	(JOG) Acceleration/deceleration rate [kHz/s]	1000.000
27	(JOG) Starting speed [Hz]	500
28	(JOG) Operating speed [high] [Hz]	5000

4. After changing the operating condition, click the [Writing data] icon in the toolbar to download to the driver.



10-4 Positioning operation

This section explains an example to perform positioning operation using the **MEXE02**.
When using the pulse input type, set operation data to the host controller to perform operation.

Note Before operating the motor, check the condition of the surrounding area to ensure safety.

STEP 1 Set the operation data using the MEXE02

Using the **MEXE02**, set the operation data of No.0 as follows.

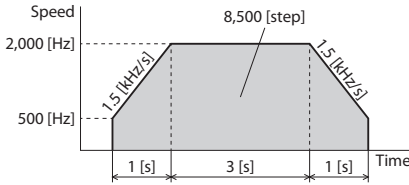

● Operation data setting screen

	Operation type	Position [step]	Speed [Hz]	Acceleration [kHz/s]	Stopping deceleration [kHz/s]
#0	Incremental positioning (based on command position)	8500	2000	1.500	1.500
#1	Incremental positioning (based on command position)	0	1000	1000.000	1000.000

Input in increments of 0.001 kHz/s.

STEP 2 Operate the motor

1. Click the [Teaching, remote operation] icon in the toolbar or click the [Teaching, remote operation] short-cut button.

The teaching, remote operation window appears.



2. Click "Start the teaching remote operation."
The pop-up window (Warning) appears, and click [Yes].

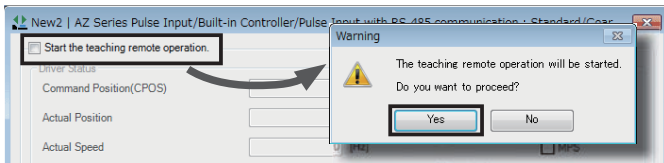

Teaching, remote operation is enabled, and red color and green color on the PWR/ALM LED blink simultaneously. (Red and green colors may overlap and it may be visible to orange.)

- Write the edited data to the driver. Click "Writing all data. (PC → product)," and click [OK].
The contents of the data No.0 will be written to the driver.

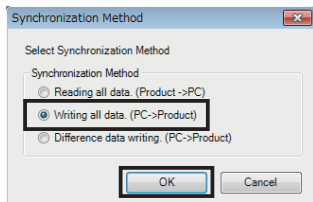

- Click [Start positioning operation].
The pop-up window (Warning) appears, and click [Yes].

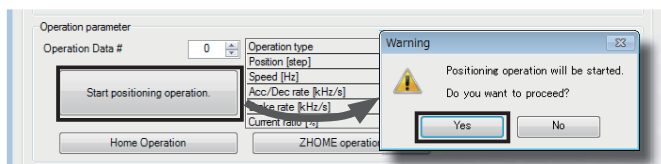

The motor performs positioning operation.

10-5 High-speed return-to-home operation

Using high-speed return-to-home operation (ZHOME) can return the motor position to the home easily.

STEP 1 Check the present position

Check the "Command position" in the teaching, remote operation window.

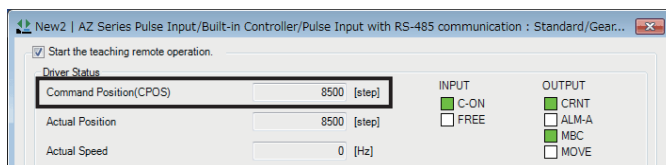

STEP 2 Execute high-speed return-to-home operation

- Click [ZHOME operation].
The pop-up window (Warning) appears, and click [Yes].
The motor will start high-speed return-to-home operation.

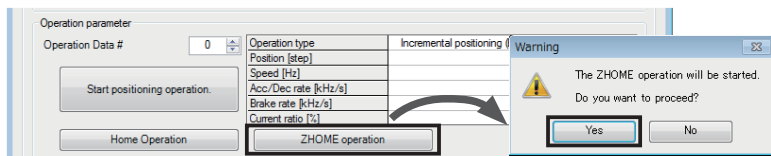

2. After the motor returns to the home, check that "Command position" is 0.

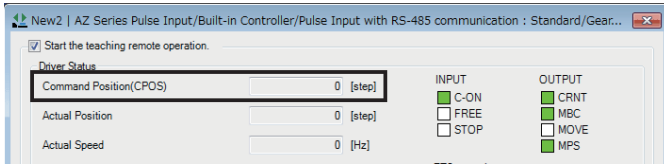

● When changing the operating condition of high-speed return-to-home operation

1. Click on "Motor & mechanism(coordinates/JOG/home operation)" under "Parameter," in the left side of the screen. The "Motor & mechanism" parameter window appears.

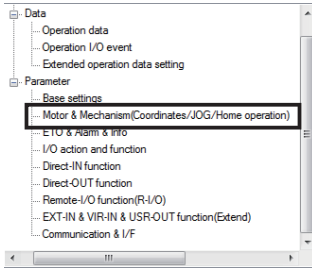

2. Change the "JOG/HOME/ZHOME operation setting" parameter to "Manual setting."
3. Change the operating condition using following three parameters.

Operation data	Motor & Mechanism(Coordinates/JOG/Home operation)	
29	(ZHOME) Operation speed [Hz]	5000
30	(ZHOME) Acceleration/deceleration rate [kHz/s]	1000 000
31	(ZHOME) Starting speed [Hz]	500

4. After changing the operating condition, click the [Writing data] icon in the toolbar to download to the driver.



STEP 3 End the teaching, remote operation

To end the teaching, remote operation, unselect "Start the teaching remote operation."

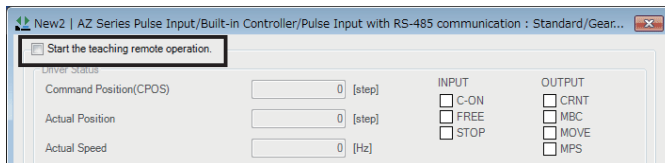

10-6 Timing chart

This section shows ON/OFF timings for input signals and output signals.
For details, check with the [OPERATING MANUAL AZ Series Function Edition](#).

■ Positioning operation

● Built-in controller type

Positioning operation can be performed with selecting the operation data.

1. Turn on the control power supply and main power supply.
The READY output will turn ON.
2. Check the READY output is turned ON and turn the START input ON by selecting the operation data number with the M0 to M2 inputs.
The motor starts positioning operation.
3. Check the READY output has been turned OFF and turn the START input OFF.
When the operation is complete, the READY output will turn ON.

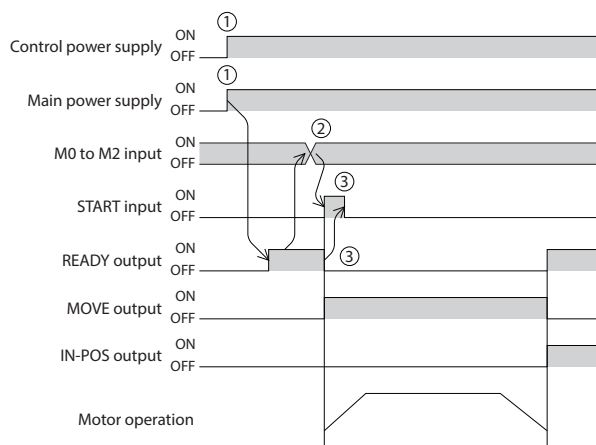

● **Pulse input type with RS-485 communication interface, pulse input type**

Positioning operation is performed by inputting pulses.

1. Turn on the control power supply and main power supply.
The READY output and PLS-RDY output will turn ON.
2. Check the PLS-RDY output has been turned ON and input pulses.
The motor starts positioning operation.
When the pulse is stopped inputting and the operation is complete, the READY output will turn ON.

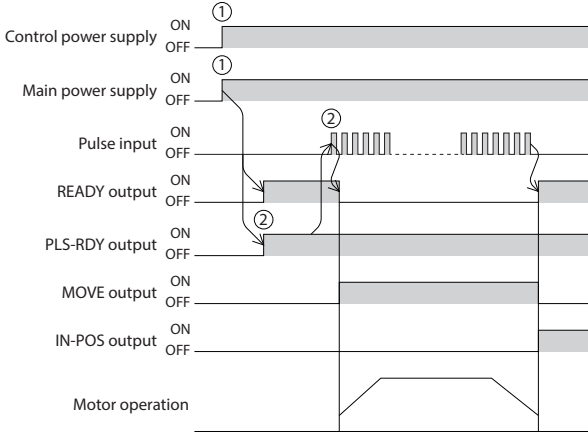

● **When using in the 1-pulse input mode.**

Perform the following settings beforehand when using in the 1-pulse input mode.

Pulse input type with RS-485 communication interface;

1. Click on "Communication I/F function" under "Parameter," in the left side of the screen.
The "Communication I/F function" parameter window appears.

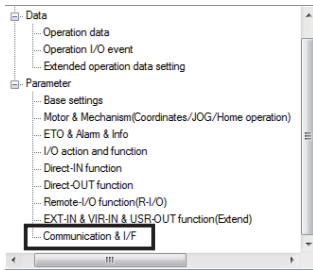

2. Set the "PULSE-I/F mode selection" parameter to "1-PULSE:"

Operation data		Communication & I/F
1	PULSE-I/F mode selection	1-PULSE

3. After changing the operating condition, click the [Writing data] icon in the toolbar to download to the driver.



4. Turn on the control power supply of the driver again.
The changed parameter is updated.

Pulse input type;

1. Set the SW1-No.2 to ON.
2. Turn on the control power supply of the driver again.
The changed setting is enabled.

High-speed return-to-home operation (ZHOME operation)

High-speed return-to-home operation is used to return to the home that is set by the **MEXE02** or HOME PRESET switch.

1. Turn on the control power supply and main power supply.
The READY output and PLS-RDY output will turn ON.
2. Check the READY output has been turned ON and turn the ZHOME input ON.
The READY output will turn OFF, and the motor will start high-speed return-to-home operation.
3. Check the READY output has been turned OFF and turn the ZHOME input OFF.
When the home is detected, the operation will be stopped.
The HOME-END output and READY output will turn ON.

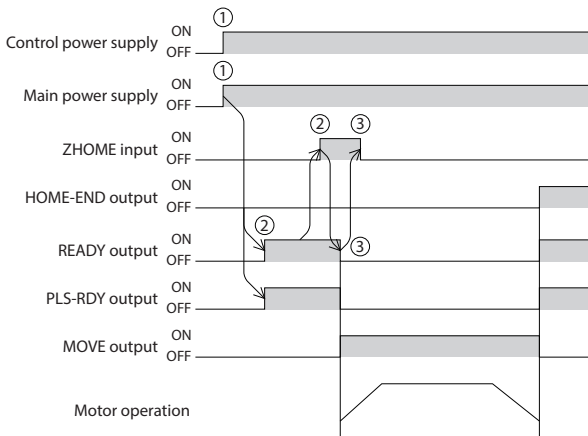

■ JOG operation

Constant speed operation can be performed with JOG operation. The motor operates continuously while the FW-JOG input or RV-JOG input is being ON.

1. Turn on the control power supply and main power supply.
The READY output and PLS-RDY output will turn ON.
2. Check the READY output has been turned ON and turn the FW-JOG input or RV-JOG input ON.
The motor will start operation.
When the FW-JOG input is turned ON, the motor rotates in the forward direction, and when the RV-JOG input is turned ON, the motor rotates in the reverse direction.
3. Turn the input signal OFF.
The motor will decelerate to a stop. When the motor stops, the READY output will turn ON.

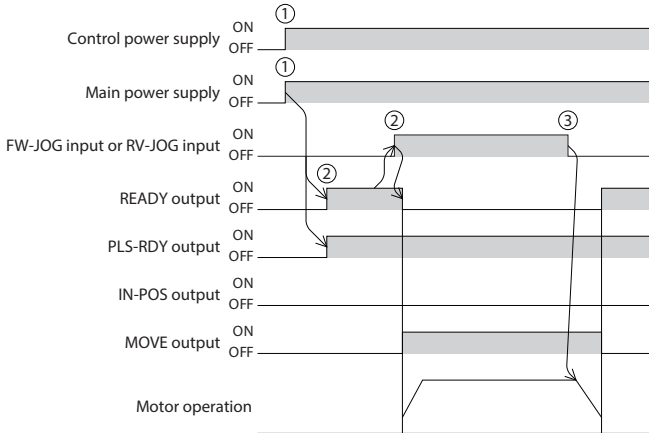

11 Inspection and maintenance

11-1 Inspection

It is recommended that periodic inspections be conducted for the items listed below after each operation of the motor. If an abnormal condition is noted, discontinue any use and contact your nearest Oriental Motor sales office.

■ Inspection item

- Check if the openings in the driver are clogged.
- Check if any of the driver mounting screws is loose.
- Check if any of the connection parts of the driver is loose.
- Check if dust and others attach on the driver.
- Check if the driver has unusual smells or appearance defects.



The driver uses semiconductor components. Static electricity may damage the semiconductor components of the driver, so be extremely careful when handling them.

11-2 Warranty

Check on the Oriental Motor Website or General Catalog for the product warranty.

11-3 Disposal

Dispose the product correctly in accordance with laws and regulations, or instructions of local governments.

12 Alarm (protective function)

When an alarm generates, the ALM-B output will turn OFF and PWR/ALM LED will blink in red.
 Before resetting an alarm, always remove the cause of the alarm and ensure safety.
 If the motor cannot be operated properly after resetting the alarm, the driver may have been damaged.
 For details about alarms, refer to the OPERATING MANUAL AZ Series Function Edition.

■ Reset alarm

- Turn on the control power supply of the driver again.
- Click [Alarm reset] on the **MEXE02**.

■ Example of the alarm monitor screen of the MEXE02

The alarm message can be checked using the "Alarm monitor" of the **MEXE02**.

Resets the alarm.

Resets the alarm.

The cause that generated the alarm is displayed.

The measures are displayed.

13 Troubleshooting

During motor operation, the motor or driver may fail to function properly due to an improper setting or wiring. When the motor cannot be operated correctly, refer to the contents provided in this section and take appropriate action. If the problem persists, contact your nearest Oriental Motor sales office.

This chapter describes problems that may occur in operation other than the initial settings. Refer to the OPERATING MANUAL AZ Series Function Edition for these contents.

Phenomenon	Possible cause	Remedial action
<ul style="list-style-type: none"> • The motor is not excited. • The motor output shaft can be moved by hand. 	Connection error in the motor cable.	Check the connections between the driver and motor.
	The FREE input is being ON.	Turn the FREE input OFF.
The motor has a holding torque even if it is put into a non-excitation state.	Effect of dynamic brake.	If the motor is put into a non-excitation state using the C-ON input or the STOP-COFF input, the motor windings is brought into a state of being short-circuited inside the driver, generating a larger holding torque than when no current is supplied (dynamic brake). To release the dynamic brake, shut off the control power supply or turn the FREE input ON.
The motor does not operate.	An electromagnetic brake motor is used and the electromagnetic brake is in the holding state.	Check the connections between electromagnetic brake and driver.
	The STOP input is being ON.	Turn the STOP input OFF.
	The position (distance) is not set in the operation data while positioning operation.	Check the operation data.
	The FW-JOG input and RV-JOG input are turned ON simultaneously in the JOG operation.	After turning both the FW-JOG input and RV-JOG input OFF, turn either one of them ON.
The motor does not rotate although the READY LED is lit. (only for pulse-input type)	<ul style="list-style-type: none"> • Signals are not connected properly. • Multiple signals have been input simultaneously. 	<ul style="list-style-type: none"> • Wire signals correctly. • Check if the signal line is disconnected. • Check if the wrong signal is input.
The motor rotates in the direction opposite to the specified direction.	The "Motor rotation direction" parameter is set wrong.	Check the setting of the "Motor rotation direction" parameter.
The gear output shaft rotates in the direction opposite to the motor.	A gear that rotates in the direction opposite to the motor output shaft is used.	<ul style="list-style-type: none"> • With TS geared type, the gear output shaft rotates in the direction opposite to the motor when the gear ratio is 20 or 30. • With Harmonic geared type, the gear output shaft always rotates in the direction opposite to the motor.
Motor operation is unstable.	Connection error in the motor or power supply.	Check the connections between the driver, motor, and main power supply.
	The base current rate setting is too low.	<ul style="list-style-type: none"> • Built-in controller type or the pulse input type with RS-485 communication interface; Check the setting of the "Base current" parameter. If the current is too low, the motor torque will also be too low and operation will be unstable. • Pulse input type; Check the setting of the CURRENT switch. If the current is too low, the motor torque will also be too low and operation will be unstable.

Phenomenon	Possible cause	Remedial action
Motor vibration is too great.	Load is too small.	<ul style="list-style-type: none"> • Built-in controller type, pulse input type with RS-485 communication interface; Lower the current using the "Base current" parameter. Vibration will increase if the motor's output torque is too large for the load. • Pulse input type; Lower the current using the CURRENT switch. Vibration will increase if the motor's output torque is too large for the load.
The electromagnetic brake does not release.	The control power supply is not supplied to the electromagnetic brake.	Check the connection of the electromagnetic brake.



- Check the alarm message using the **MEXE02** when the alarm generates.
- I/O signals can be monitored using the **MEXE02**. Use to check the wiring condition of the I/O signals.

14 To use the product in more convenient manners

Using the **MEXE02**, you can set the operation data or change I/O signals that assign to the CN5 connector. Also, you can monitor the operating status or perform test operation.

Refer to the **OPERATING MANUAL AZ Series Function Edition** for details about operation.

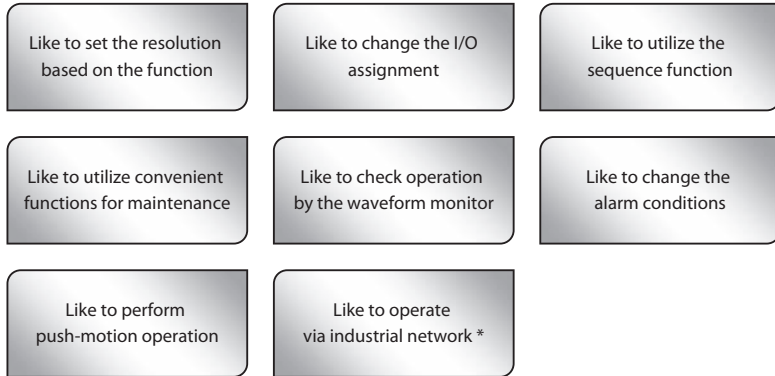

* Excluding the pulse input type.

15 Cables

15-1 Connection cables

■ Connection cable sets/Flexible connection cable sets

This is a cable set needed when a motor and driver are connected. It is a set of two cables for the motor and encoder. For the cable set of electromagnetic brake motors, a set of three cables for the motor, encoder and electromagnetic brake is provided.

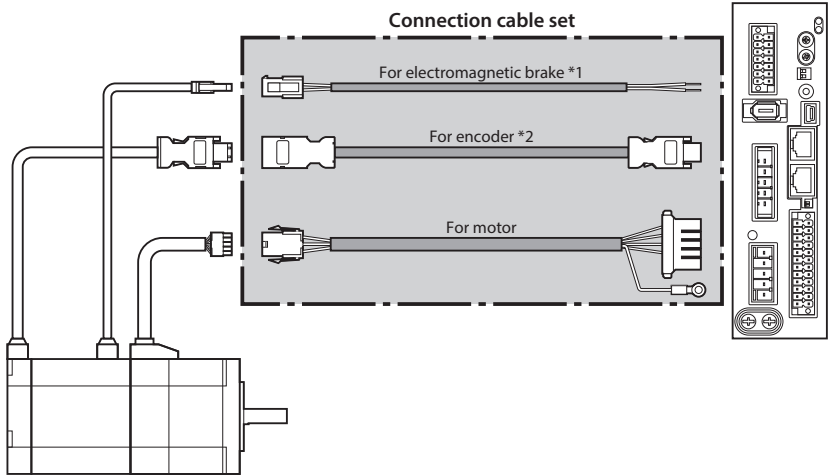

*1 Only when the motor is of electromagnetic brake type.

*2 Use the cable for encoder when the length of the encoder cable of motor is not enough.

memo When installing the motor on a moving part, use a flexible cable having excellent flex resistance.

- Connection cable sets

For motor/encoder

Model	Length [m (ft.)]
CC005VZF	0.5 (1.6)
CC010VZF	1 (3.3)
CC015VZF	1.5 (4.9)
CC020VZF	2 (6.6)
CC025VZF	2.5 (8.2)
CC030VZF	3 (9.8)
CC040VZF	4 (13.1)
CC050VZF	5 (16.4)
CC070VZF	7 (23.0)
CC100VZF	10 (32.8)
CC150VZF	15 (49.2)
CC200VZF	20 (65.6)

For motor/encoder/electromagnetic brake

Model	Length [m (ft.)]
CC005VZFB	0.5 (1.6)
CC010VZFB	1 (3.3)
CC015VZFB	1.5 (4.9)
CC020VZFB	2 (6.6)
CC025VZFB	2.5 (8.2)
CC030VZFB	3 (9.8)
CC040VZFB	4 (13.1)
CC050VZFB	5 (16.4)
CC070VZFB	7 (23.0)
CC100VZFB	10 (32.8)
CC150VZFB	15 (49.2)
CC200VZFB	20 (65.6)

- Flexible connection cable sets

For motor/encoder

Model	Length [m (ft.)]
CC005VZR	0.5 (1.6)
CC010VZR	1 (3.3)
CC015VZR	1.5 (4.9)
CC020VZR	2 (6.6)
CC025VZR	2.5 (8.2)
CC030VZR	3 (9.8)
CC040VZR	4 (13.1)
CC050VZR	5 (16.4)
CC070VZR	7 (23.0)
CC100VZR	10 (32.8)
CC150VZR	15 (49.2)
CC200VZR	20 (65.6)

For motor/encoder/electromagnetic brake

Model	Length [m (ft.)]
CC005VZRB	0.5 (1.6)
CC010VZRB	1 (3.3)
CC015VZRB	1.5 (4.9)
CC020VZRB	2 (6.6)
CC025VZRB	2.5 (8.2)
CC030VZRB	3 (9.8)
CC040VZRB	4 (13.1)
CC050VZRB	5 (16.4)
CC070VZRB	7 (23.0)
CC100VZRB	10 (32.8)
CC150VZRB	15 (49.2)
CC200VZRB	20 (65.6)

■ Extension cable sets/Flexible extension cable sets

This is a cable set needed when a motor and driver are relayed. It is a set of two cables for the motor and encoder. For the cable set of electromagnetic brake motors, a set of three cables for the motor, encoder and electromagnetic brake is provided.

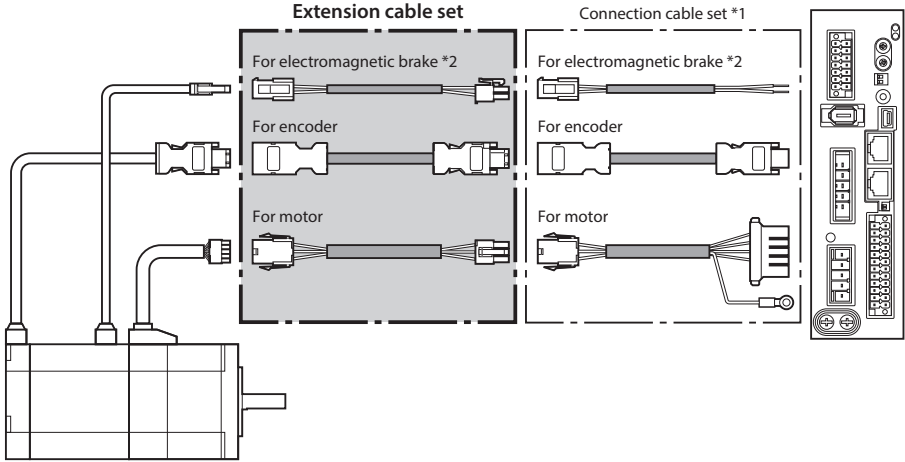

*1 Use the connection cable set used.

*2 Only when the motor is of electromagnetic brake type.



- When installing the motor on a moving part, use a flexible cable having excellent flex resistance.
- When extending the wiring length by connecting an extension cable to the connection cable, keep the total cable length to 20 m (65.6 ft.) or less.

● Extension cable sets

For motor/encoder

Model	Length [m (ft.)]
CC010VZFT	1 (3.3)
CC020VZFT	2 (6.6)
CC030VZFT	3 (9.8)
CC050VZFT	5 (16.4)
CC070VZFT	7 (23.0)
CC100VZFT	10 (32.8)
CC150VZFT	15 (49.2)

For motor/encoder/electromagnetic brake

Model	Length [m (ft.)]
CC010VZFBT	1 (3.3)
CC020VZFBT	2 (6.6)
CC030VZFBT	3 (9.8)
CC050VZFBT	5 (16.4)
CC070VZFBT	7 (23.0)
CC100VZFBT	10 (32.8)
CC150VZFBT	15 (49.2)

● Flexible extension cable sets

For motor/encoder

Model	Length [m (ft.)]
CC010VZRT	1 (3.3)
CC020VZRT	2 (6.6)
CC030VZRT	3 (9.8)
CC050VZRT	5 (16.4)
CC070VZRT	7 (23.0)
CC100VZRT	10 (32.8)
CC150VZRT	15 (49.2)

For motor/encoder/electromagnetic brake

Model	Length [m (ft.)]
CC010VZRB	1 (3.3)
CC020VZRB	2 (6.6)
CC030VZRB	3 (9.8)
CC050VZRB	5 (16.4)
CC070VZRB	7 (23.0)
CC100VZRB	10 (32.8)
CC150VZRB	15 (49.2)

15-2 I/O signal cables

■ Connector assembly types

This cable is a shielded cable for good noise immunity in order to connect the I/O signals of the controller to the driver. The ground wires useful to grounding are provided at both ends of the cable. A connector is assembled at the driver side.

Model	Length [m (ft.)]	Number of poles
CC24D005C-1	0.5 (1.6)	24
CC24D010C-1	1 (3.3)	
CC24D020C-1	2 (6.6)	

15-3 RS-485 communication cable

This cable is necessary when connecting two or more drivers of the built-in controller type or the pulse input type with RS-485 communication interface. It can connect between drivers by connecting to the CN6 and CN7 connectors. Also, it can be used when connecting the driver and the network converter.

Model: **CC002-RS4** [0.25 m (0.8 ft.)]

16 Accessories

16-1 Pulse signal converter for noise immunity

This product converts a pulse signal, which is output from the open collector output, to a pulse signal for good noise immunity by outputting the pulse signal again from the differential output.

Model: **VCS06**

16-2 Relay contact protection parts/circuits

■ CR circuit for surge suppression

This product is effective to suppress the surge which occurs in a relay contact part. Use it to protect the contacts of the relay or switch.

Model: **EPCR1201-2**

■ CR circuit module

This product is effective to suppress the surge which occurs in a relay contact part. Use this product to protect the contacts of the relay or switch.

Four pieces of CR circuit for surge suppression are mounted on the compact circuit, and this product can be installed to the DIN rail. This product can make the wiring easily and securely since it also supports terminal block connection.

Model: **VCS02**

16-3 Regeneration resistor

Connect the regeneration resistor if gravitational operation or other operations involving up/down movement, or sudden starting/stopping of a large inertial load, will be repeated frequently.

Always connect the regeneration resistor if an overvoltage protection warning or alarm generates.

Model: **RGB100**

- Unauthorized reproduction or copying of all or part of this Operating Manual is prohibited.
If a new copy is required to replace an original manual that has been damaged or lost, please contact your nearest Oriental Motor sales office.
- Oriental Motor shall not be liable whatsoever for any problems relating to industrial property rights arising from use of any information, circuit, equipment or device provided or referenced in this manual.
- Characteristics, specifications and dimensions are subject to change without notice.
- While we make every effort to offer accurate information in the manual, we welcome your input. Should you find unclear descriptions, errors or omissions, please contact your nearest Oriental Motor sales office.
- **Orientalmotor**, **αSTEP**, **αFLEX** and ABZO sensor are registered trademarks or trademarks of Oriental Motor Co., Ltd., in Japan and other countries.

Modbus is a registered trademark of the Schneider Automation Inc.

Other product names and company names mentioned in this manual may be registered trademarks or trademarks of their respective companies and are hereby acknowledged. The third-party products mentioned in this manual are recommended products, and references to their names shall not be construed as any form of performance guarantee. Oriental Motor is not liable whatsoever for the performance of these third-party products.

© Copyright ORIENTAL MOTOR CO., LTD. 2016

Published in November 2020

• Please contact your nearest Oriental Motor office for further information.

ORIENTAL MOTOR U.S.A. CORP
Technical Support Tel:800-468-3982
8:30am EST to 5:00pm PST (M-F)
www.orientalmotor.com

ORIENTAL MOTOR (EUROPA) GmbH
Schiessstraße 44, 40549 Düsseldorf, Germany
Technical Support Tel:00 800/22 55 66 22
www.orientalmotor.de

ORIENTAL MOTOR (UK) LTD.
Tel:+44-1256347090
www.oriental-motor.co.uk

ORIENTAL MOTOR (FRANCE) SARL
Tel:+33-1 47 86 97 50
www.orientalmotor.fr

ORIENTAL MOTOR ITALIA s.r.l.
Tel:+39-02-93906347
www.orientalmotor.it

ORIENTAL MOTOR ASIA PACIFIC PTE. LTD.
Singapore
Tel:1800-842-0280
www.orientalmotor.com.sg

ORIENTAL MOTOR (MALAYSIA) SDN. BHD.
Tel:1800-806-161
www.orientalmotor.com.my

ORIENTAL MOTOR (THAILAND) CO., LTD.
Tel:1800-888-881
www.orientalmotor.co.th

ORIENTAL MOTOR (INDIA) PVT. LTD.
Tel:1800-120-1995 (For English)
1800-121-4149 (For Hindi)
www.orientalmotor.co.in

TAIWAN ORIENTAL MOTOR CO., LTD.
Tel:0800-060708
www.orientalmotor.com.tw

SHANGHAI ORIENTAL MOTOR CO., LTD.
Tel:400-820-6516
www.orientalmotor.com.cn

INA ORIENTAL MOTOR CO., LTD.
Korea
Tel:080-777-2042
www.inaom.co.kr

ORIENTAL MOTOR CO., LTD.
4-8-1 Higashiueno, Taito-ku, Tokyo
110-8536 Japan
Tel:+81-3-6744-0361
www.orientalmotor.co.jp