



Speed Control Motor and Controller Package

DSC Series

Electromagnetic brake type

OPERATING MANUAL



Thank you for purchasing an Oriental Motor product.
This Operating Manual describes product handling procedures and safety precautions.

- Please read it thoroughly to ensure safe operation.
- Always keep the manual where it is readily available.

D-loop

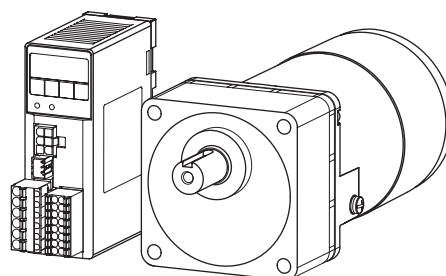

D-loop

D-loop represents the speed control motor which adopted Oriental Motor's unique technology.

This product achieves high reliability using closed loop control in addition to downsize the speed controller by digitizing the phase control circuit.

Table of contents

1	Introduction	3	6.6	Timing chart.....	22
2	Safety precautions	4	6.7	Operating cycle	23
3	Preparation	5	■	Limitation in vertical operation.....	23
3.1	Checking the product	5	6.8	Brake current.....	23
3.2	How to identify the product model.....	5	6.9	Operating in vertical direction.....	24
3.3	List of combinations	6	■	Notes about vertical operation	24
3.4	Names and functions of parts	7	■	Conditions for vertical operation.....	24
4	Installation.....	8	6.10	Operating in two or more speed (multi-speed operation)	25
4.1	Location for installation	8	6.11	Adjusting the rotation speed of two or more motors by a single speed setter (multi-motor control)	26
4.2	Installing the motor	8	7	Function	27
■	Installing to equipment	8	7.1	Functions list	27
■	Removing / Installing the gearhead.....	9	7.2	Setting items and panel displays.....	28
■	For the motor equipped with cooling fan (90 W)	9	7.3	Items which can be monitored	30
4.3	Installing a load	10	7.4	Setting the operation data	30
4.4	Permissible radial load and permissible axial load	10	7.5	Setting the parameters.....	31
4.5	Installing the speed controller	11	■	Parameter list.....	31
4.6	Installing the capacitor	12	■	Displayed digit number when setting the speed reduction ratio or speed increasing ratio.....	32
4.7	Installing an external potentiometer	12	■	How to calculate the speed reduction ratio when displaying the conveyor transfer speed	32
5	Connection.....	13	■	Limiting the setting range of the rotation speed	32
5.1	Connecting method	13	■	Stop mode selection.....	33
5.2	Connecting the AC power supply and capacitor.....	14	■	Setting the deceleration control.....	33
5.3	Connecting the motor and speed controller	14	■	Description of I/O signals which can be assigned.....	34
5.4	Grounding the motor	14	7.6	Releasing operation of electromagnetic brake.....	34
5.5	Connecting the control DC power supply and I/O signals.....	15	7.7	Prohibiting data editing.....	34
5.6	Connection example for I/O signals and programmable controller	17	8	Alarm and warning.....	35
6	Operation	18	8.1	Alarm.....	35
6.1	Power ON.....	18	8.2	Warning	36
■	Test operation.....	19	9	Troubleshooting and remedial actions	37
■	Releasing the electromagnetic brake.....	19	10	Inspection	38
6.2	Starting, stopping	19	11	Standard and CE Marking	39
6.3	Setting the rotation speed	20	11.1	Standard and CE Marking.....	39
■	Setting method using the operation panel	20	11.2	Installing and wiring in compliance with EMC Directive.....	40
■	Remote setting method	21	12	General specifications	42
6.4	Setting the acceleration time and deceleration time.....	21	13	Accessories (sold separately).....	43
6.5	Motor rotation direction	22			

1 Introduction

■ Before use

Only qualified and educated personnel should work with the product.

Use the product correctly after thoroughly reading the section "2 Safety precautions" on p.4.

The items under **Note** contain important handling instructions that the user should observe to ensure safe use of the product. **Note** is described in the related handling items.

The product described in this manual has been designed and manufactured to be incorporated in general industrial equipment. Do not use for any other purpose.

Oriental Motor Co., Ltd. is not responsible for any damage caused through failure to observe this warning.

■ Overview of the product



The product is a speed control motor and controller package equipped with closed loop control system which achieves high reliability.



This product controls the motor rotation speed by constantly utilizing feedback from the tachogenerator built in the AC motor so that the set rotation speed can be maintained even if a load is fluctuated.

The motor, equipping a power-off activated type electromagnetic brake, can be used for applications required holding a load in a vertical operation or horizontal operation. The speed controller has various alarms to notify the motor malfunction in addition to displaying the speed and operating with maximum four types of operation data.

2 Safety precautions

The precautions described below are intended to prevent danger or injury to the user and other personnel through safe, correct use of the product. Use the product only after carefully reading and fully understanding these instructions.

 Warning Handling the product without observing the instructions that accompany a “Warning” symbol may result in serious injury or death.	
<p>General</p> <ul style="list-style-type: none"> Do not use the product in explosive or corrosive environments, in the presence of flammable gases, locations subjected to splashing water, or near combustibles. Doing so may result in fire, electric shock or injury. Only qualified and educated personnel should be allowed to perform installation, connection, operation and inspection/troubleshooting of the product. Handling by unqualified and uneducated personnel may result in fire, electric shock, or injury. Do not transport, install, connect or inspect the product while the power is supplied. Always turn the power off before carrying out these operations. Failure to do so may result in electric shock. The terminals on the speed controller front panel marked with   symbol indicate the presence of high voltage. Do not touch the CN1, CN2 and CN3 while the power is ON. Doing so may result in fire or electric shock. <p>Installation</p> <ul style="list-style-type: none"> The motor is Class I equipment. When installing the motor, ground the Protective Earth Terminal of the motor. Failure to do so may result in electric shock. Install the motor and speed controller in an enclosure. Failure to do so may result in electric shock or injury. <p>Connection</p> <ul style="list-style-type: none"> For the AC power supply voltage of the speed controller, use the same power supply voltage as the motor specification. Failure to do so may result in fire or damage to equipment. The speed controller has no built-in fuse for overcurrent protection. Be sure to connect a device for fuse in the power input line. Failure to do so may result in fire. 	<ul style="list-style-type: none"> Securely connect the cables in accordance with the connection examples. Failure to do so may result in fire or electric shock. Do not forcibly bend, pull or pinch the cable. Doing so may cause fire or electric shock. Be sure to observe the specified cable sizes. Use of unspecified cable sizes may result in fire. Insulate the connection terminals of the supplied capacitor using the supplied capacitor cap. Failure to do so may result in electric shock. <p>Operation</p> <ul style="list-style-type: none"> When using the motor in a vertical operation, provide a safety device to the equipment side in order to prevent from falling a load. Doing so may result in injury or damage to equipment. Do not use the brake mechanism of the electromagnetic brake motor as a safety brake. Doing so may result in injury or damage to equipment. When using the motor in a vertical operation, do not turn the FREE input ON. The holding power of the electromagnetic brake will be lost, causing personal injury or damage to equipment. When using the motor in a vertical operation, be sure to check the load condition before operating. If a load exceeding the condition that can operate the motor, the load may fall. This may cause injury or damage to equipment. <p>Maintenance and inspection</p> <ul style="list-style-type: none"> Do not touch the connector of the speed controller immediately after the power is turned off (for a period of 1 minute). The residual voltage may cause electric shock. <p>Disassembly and modification</p> <ul style="list-style-type: none"> Do not disassemble or modify the motor and speed controller. This may cause electric shock or injury.

 Caution Handling the product without observing the instructions that accompany a “Caution” symbol may result in injury or property damage.	
<p>General</p> <ul style="list-style-type: none"> Do not use the motor and speed controller beyond their specifications. Doing so may result in electric shock, injury or damage to equipment. Do not carry the motor by holding the motor output shaft or motor cable. Doing so may result in injury. If an alarm of the speed controller is generated, first remove the cause and then reset the alarm. Failure to do so may result in injury or damage to equipment. <p>Installation</p> <ul style="list-style-type: none"> Keep the area around the motor and speed controller free of combustible materials. Failure to do so may result in fire or a skin burn(s). Do not leave anything around the motor and speed controller that would obstruct ventilation. Doing so may result in damage to equipment. Securely install the motor and speed controller to the mounting plate and DIN rail respectively. Inappropriate installation may cause the motor and speed controller to detach and fall, resulting in injury or equipment damage. <p>Connection</p> <ul style="list-style-type: none"> Do not wire the electromagnetic contactor or power relay between the motor and speed controller. To switch the rotation direction using the electromagnetic contactor may cause damage to equipment. 	<p>Operation</p> <ul style="list-style-type: none"> Use a motor and speed controller only in the specified combination. An incorrect combination may cause a fire. Provide an emergency stop device or emergency stop circuit external to the equipment so that the entire equipment will operate safely in the event of a system failure or malfunction. Failure to do so may result in injury. Immediately when trouble has occurred, stop running and turn off the speed controller power. Failure to do so may result in fire, electrical shock or injury. Do not touch the rotating part (output shaft) while operating the motor. Doing so may result in injury. The motor surface temperature may exceed 70 °C (158 °F) even under normal operating conditions. If the operator is allowed to approach a running motor, attach a warning label as shown in the figure in a conspicuous position. Failure to do so may result in skin burn(s). <div style="text-align: right;">  <p>Warning label</p> </div> <p>Maintenance and inspection</p> <ul style="list-style-type: none"> Conduct the insulation resistance measurement or dielectric strength test separately on the motor and speed controller. Conducting while the motor and speed controller are connected may result in damage to equipment. <p>Disposal</p> <ul style="list-style-type: none"> To dispose of the motor and speed controller, disassemble it into parts and components as much as possible and dispose of individual parts/components as industrial waste.

3 Preparation

3.1 Checking the product

Verify that the items listed below are included. Report any missing or damaged items to the branch or sales office from which you purchased the product.

Verify the model number of the purchased product against the number shown on the package label.

Check the model number of the motor, gearhead and speed controller against the number shown on the nameplate.

- Motor 1 unit
(A motor and gearhead are pre-assembled)
- Speed controller 1 unit
- Capacitor 1 pc
- Capacitor cap 1 pc
- Hexagonal socket head screw set..... 1 set
(Hexagonal socket head screw, flat washer, spring washer, 4 pieces each, parallel key 1 piece)
- Connection cable 1 pc
(Only models with a supplied connection cable)
- External potentiometer 1 pc
- OPERATING MANUAL (this document)..... 1 pc

3.2 How to identify the product model

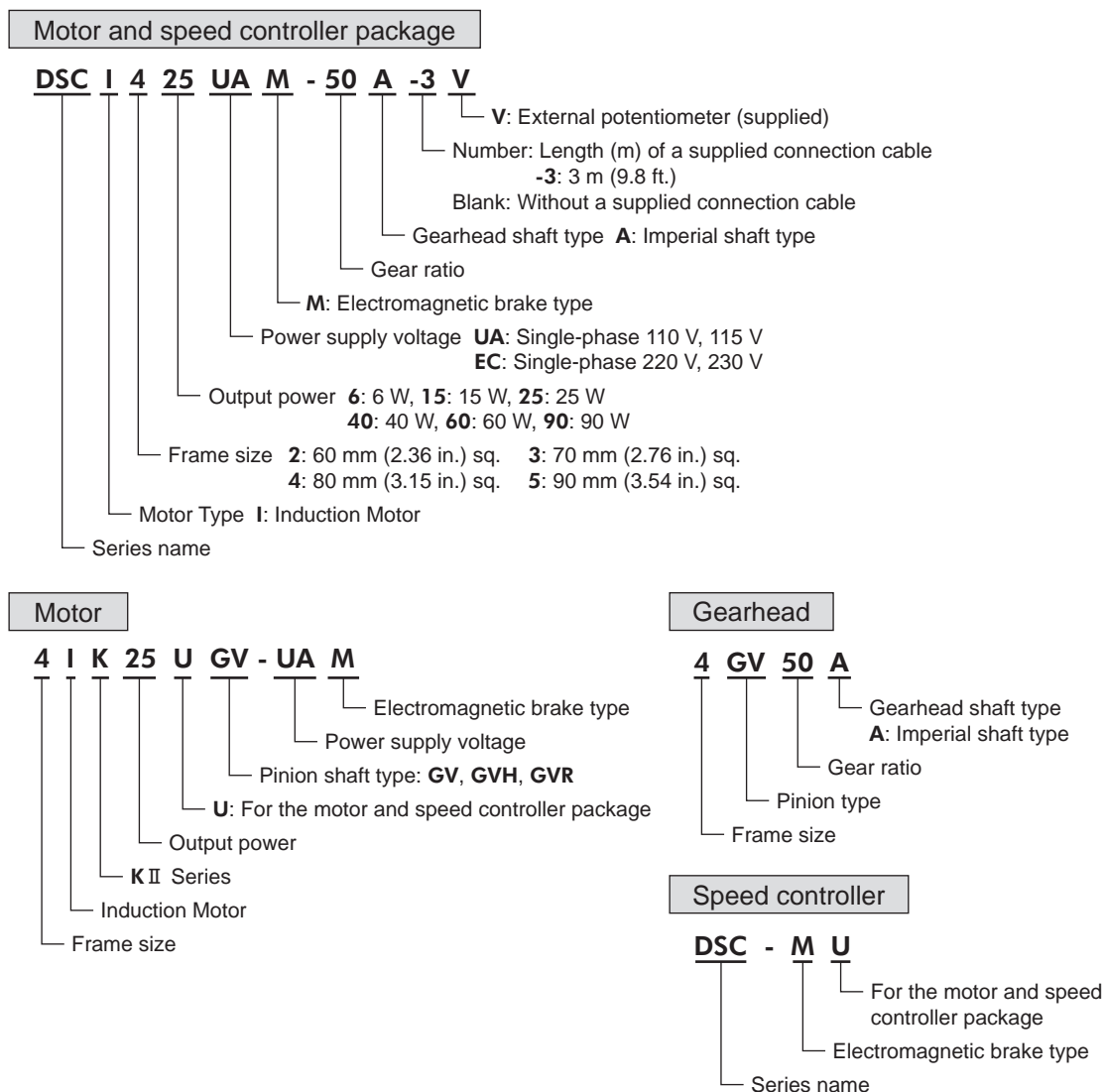

3.3 List of combinations

Model names for motor, gearhead and speed controller are shown below.

Enter the gear ratio in the box (□) within the model name.

Enter the cable length (-3) in the box (■) within the model name when the connection cable is supplied.

Motor output power	Power supply voltage	Model	Motor model	Gearhead model	Speed controller model
6 W	Single-phase 110/115 V	DSCI26UAM-□A■V	2IK6UGV-UAM	2GV□A	DSC-MU
	Single-phase 220/230 V	DSCI26ECM-□A■V	2IK6UGV-ECM		
15 W	Single-phase 110/115 V	DSCI315UAM-□A■V	3IK15UGV-UAM	3GV□A	
	Single-phase 220/230 V	DSCI315ECM-□A■V	3IK15UGV-ECM		
25 W	Single-phase 110/115 V	DSCI425UAM-□A■V	4IK25UGV-UAM	4GV□A	
	Single-phase 220/230 V	DSCI425ECM-□A■V	4IK25UGV-ECM		
40 W	Single-phase 110/115 V	DSCI540UAM-□A■V	5IK40UGV-UAM	5GV□A	
	Single-phase 220/230 V	DSCI540ECM-□A■V	5IK40UGV-ECM		
60 W	Single-phase 110/115 V	DSCI560UAM-□A■V	5IK60UGVH-UAM	5GVH□A	
	Single-phase 220/230 V	DSCI560ECM-□A■V	5IK60UGVH-ECM		
90 W	Single-phase 110/115 V	DSCI590UAM-□A■V	5IK90UGVR-UAM	5GVR□A	
	Single-phase 220/230 V	DSCI590ECM-□A■V	5IK90UGVR-ECM		

3.4 Names and functions of parts

■ Motor

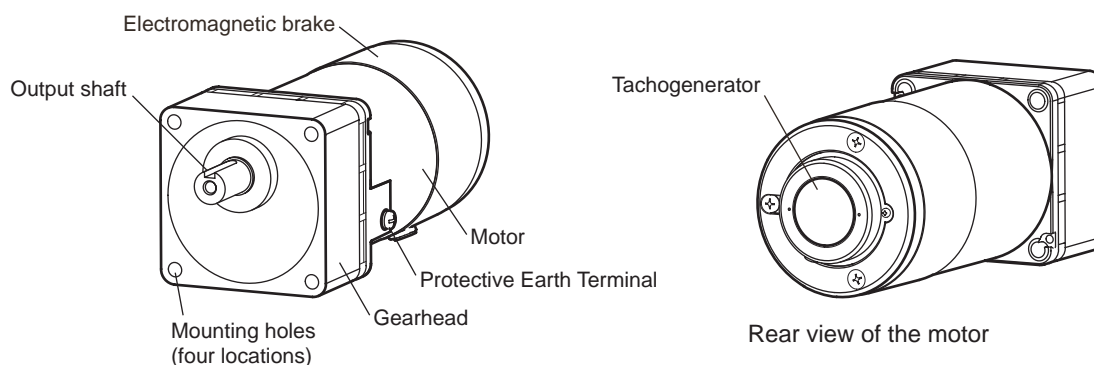

■ Speed controller

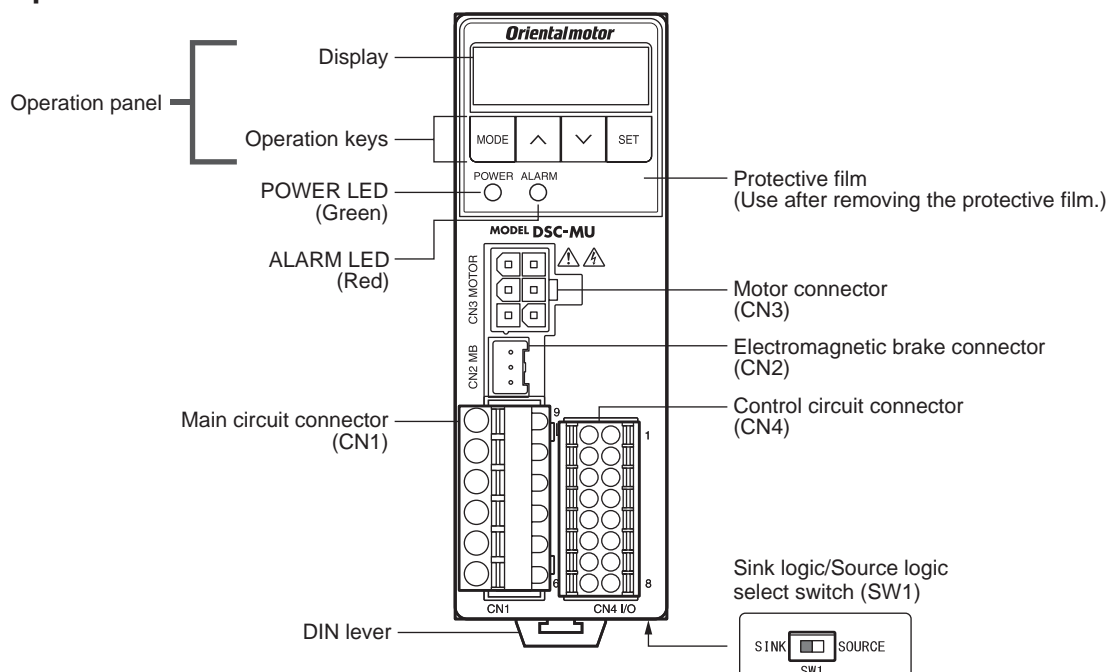

Name	Description	Reference page
Operation panel	Display (4-digit LED)	p.28
	Operation keys	
POWER LED (Green)	This LED is lit while the AC power is supplied to the speed controller.	p.18
ALARM LED (Red)	This LED blinks while an alarm generates.	p.35
Motor connector (CN3)	Connects the motor connector.	p.13
Electromagnetic brake connector (CN2)	Connects the electromagnetic brake connector.	
Main circuit connector (CN1)	Connects the AC power supply, capacitor and FG.	
Control circuit connector (CN4)	Connects the control DC power supply and I/O signals.	
Sink logic/Source logic select switch (SW1)	This switch is used for switching the input signal between sink logic and source logic modes.	p.17
DIN lever	Mounts the speed controller to a DIN rail. The speed controller can be mounted using screws.	p.11

4 Installation

This chapter explains the installation location and installation methods.

4.1 Location for installation

The motor and speed controller described in this manual have been designed and manufactured to be incorporated in general industrial equipment.

Install them in a well-ventilated location that provides easy access for inspection.

- Inside an enclosure that is installed indoors
- Operating ambient temperature
 Motor: -10 to +40 °C [+14 to +104 °F] (non-freezing)
 Speed controller: 0 to +40 °C [+32 to +104 °F] (non-freezing)
- Operating ambient humidity 85% or less (non-condensing)
- Area that is free of explosive atmosphere or toxic gas (such as sulfuric gas) or liquid
- Area not stored combustible materials
- Area not exposed to direct sun
- Area free of excessive amount of dust, iron particles or the like
- Area not subject to splashing water (rain, water droplets), oil (oil droplets) or other liquids
- Area free of excessive salt
- Area not subject to continuous vibration or excessive shocks
- Area free of excessive electromagnetic noise (from welders, power machinery, etc.)
- Area free of radioactive materials, magnetic fields or vacuum
- Altitude Up to 1000 m (3300 ft.) above sea level

4.2 Installing the motor

■ Installing to equipment

Drill tapped holes in the mounting plate and secure the product with the supplied mounting screw set through four mounting holes.

Install it so that no gaps remain between the gearhead mounting surface and mounting plate.

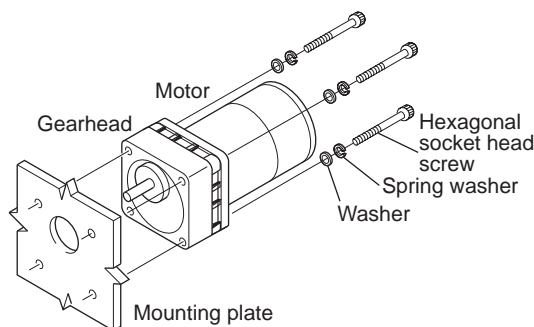

- Supplied hexagonal socket head screw set (Hexagonal socket head screws, washers, spring washers 4 pieces each)

Gearhead model	Gear ratio	Hexagonal socket head screw (Material: Stainless steel)			Tightening torque [N·m (lb-in)]	
		Screw size	L1 [mm (in.)]	L2 [mm (in.)]		
2GV□A	7.5 to 25	No.8-32UNC	50.8 (2)	8 (0.31)	1.4 (12)	
	30 to 120		57.2 (2.25)	10 (0.39)		
	150 to 360		63.5 (2.5)	12 (0.47)		
3GV□A	7.5 to 25	1/4-20UNC	57.2 (2.25)	9 (0.35)	5.0 (44)	
	30 to 120		63.5 (2.5)	10 (0.39)		
	150 to 360		69.9 (2.75)	12 (0.47)		
4GV□A	7.5 to 25		63.5 (2.5)	12 (0.47)		12.0 (106)
	30 to 120		69.9 (2.75)	14 (0.55)		
	150 to 360		76.2 (3)	15 (0.59)		
5GV□A 5GVH□A	7.5 to 18	5/16-18UNC	69.9 (2.75)	14 (0.55)	12.0 (106)	
	25 to 100		82.6 (3.25)	13 (0.51)		
	120 to 300		88.9 (3.5)	14 (0.55)		
5GVR□A	7.5 to 15		69.9 (2.75)	14 (0.55)		12.0 (106)
	18 to 36		82.6 (3.25)	13 (0.51)		
	50 to 180		95.3 (3.75)	14 (0.55)		

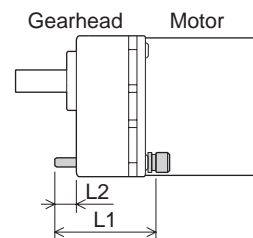

Note On rare occasions, a small amount of grease may ooze out from the gearhead. If there is a concern over possible environmental damage resulting from the leakage of grease, provide an oil tray or similar oil catching mechanism in order not to cause a secondary damage.
 Oil leakage may lead to problems in the customer's equipment or products.

■ Removing / Installing the gearhead

The gearhead or the outlet position of the motor lead wires can be changed.

• Removing the gearhead from the motor

Remove the gearhead by unscrewing the hexagonal socket-head screws holding the gearhead to the motor (2 locations).

Illustration shows the view from motor case side.

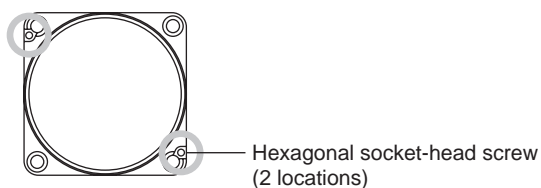

Gearhead model	Screw size	Tightening torque [N·m (lb-in)]
2GV□A 3GV□A 4GV□A	M2.6	0.4 (3.5)
5GV□A 5GVH□A 5GVR□A	M3	0.6 (5.3)

• Combining the gearhead to the motor

Using the pilot sections of the motor and gearhead as guides, slowly rotate it clockwise/counterclockwise to prevent the pinion of the motor output shaft from contacting the side panel or gear of the gearhead. Also confirm that no gaps remain between the motor and gearhead.

An O-ring is attached to the flange of the motor. Do not pinch the O-ring when assembling the motor and gearhead. Pinching the O-ring causes a grease leak from the gearhead.

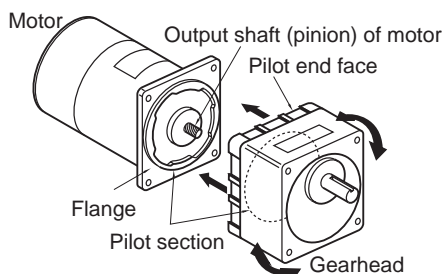

Note Do not forcibly assemble the motor and gearhead. Also, do not let metal objects or other foreign matters enter the gearhead. The pinion or gear of the motor output shaft may be damaged, resulting in noise or shorter service life.

■ For the motor equipped with cooling fan (90 W)

When installing a motor with cooling fan onto a device, leave 10 mm (0.39 in.) or more behind the fan cover or open a ventilation hole so that the cooling inlet on the back of the motor cover is not blocked.

4.3 Installing a load

When installing a load on the gearhead, pay attention to the following points.

- Align the centerline of the gearhead output shaft with the centerline of the load.
- A key slot is provided on the output shaft of the gearhead.
- Form a key slot on the load side and secure the load using the supplied parallel key.

Note

- When coupling the gearhead with a load, pay attention to centering, belt tension, parallelism of pulleys, etc. Also, firmly secure the tightening screws of the coupling or pulleys.
- When installing a load, do not damage the gearhead output shaft or bearing. Forcing in the load by driving it with a hammer, etc., may break the bearing. Do not apply any excessive force to the output shaft.
- Do not modify or machine the gearhead output shaft. The bearing may be damaged or gearhead may break.

- When using the output shaft end tapped hole of a gearhead

Use a tapped hole provided at the end of the output shaft as an auxiliary means for preventing the transfer mechanism from disengaging.

Gearhead model	Output shaft end tapped hole
4GV□A	No.10-24 UNC, Effective depth 10 mm (0.39 in.)
5GV□A 5GVH□A 5GVR□A	No.12-24 UNC, Effective depth 12 mm (0.47 in.)

The output shaft end tapped hole is not provided for the 2GV□A and 3GV□A types.

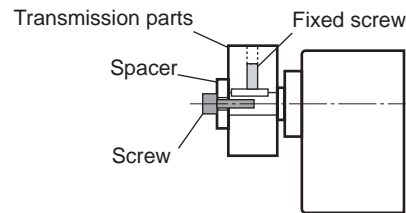

4.4 Permissible radial load and permissible axial load

The radial load and the axial load on the gearhead output shaft must be kept under the permissible values listed below.

Note

Failure due to fatigue may occur when the gearhead bearings and output shaft are subject to repeated loading by a radial or axial load that is in excess of the permissible limit.

Gearhead model	Gear ratio	Permissible radial load [N (lb.)]		Permissible axial load [N (lb.)]
		Distance from output shaft end of the gearhead 10 mm (0.39 in.)	20 mm (0.79 in.)	
2GV□A	7.5 to 25	150 (33)	200 (45)	40 (9)
	30 to 360	200 (45)	300 (67)	
3GV□A	7.5 to 25	200 (45)	300 (67)	80 (18)
	30 to 360	300 (67)	400 (90)	
4GV□A	7.5 to 25	300 (67)	350 (78)	100 (22)
	30 to 360	450 (101)	550 (123)	
5GV□A 5GVH□A	7.5 to 9	400 (90)	500 (112)	150 (33)
	12.5 to 18	450 (101)	600 (135)	
	25 to 300	500 (112)	700 (157)	
5GVR□A	7.5 to 9	400 (90)	500 (112)	
	12.5 to 18	450 (101)	600 (135)	
	25 to 180	500 (112)	700 (157)	

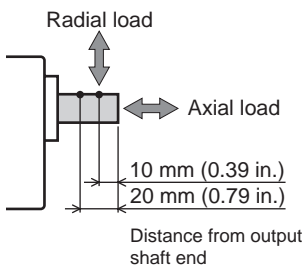

4.5 Installing the speed controller

The speed controller is designed so that heat is dissipated via air convection. Provide spaces so that the speed controller can be ventilated well through its top and bottom vent holes.

■ Installation direction

When installing speed controllers, provide a clearance of at least 25 mm (0.98 in.) in the vertical direction between the speed controller and enclosure or other equipment within the enclosure.
When installing two or more speed controllers in parallel, it is possible to install them closely in the horizontal direction.

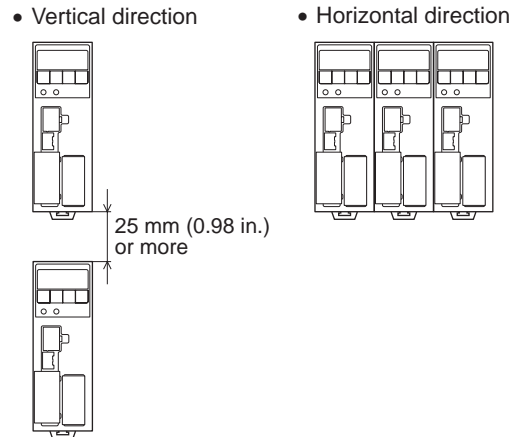

■ Installation method

● Mounting to DIN rail

Use a DIN rail 35 mm (1.38 in.) wide to mount the speed controller.
Pull down the DIN lever of the speed controller until it locks, and push in the speed controller with hanging the hook at the rear to the DIN rail, and then lift the DIN lever. After installation, secure the both sides of the speed controller with the end plate that the customer provides.

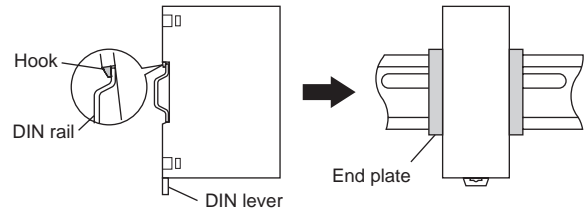

Removing from DIN rail

Pull the DIN lever down until it locks using a flat tip screwdriver, and lift the bottom of the speed controller to remove it from the rail.
Use force of about 10 to 20 N (2.2 to 4.5 lb.) to pull the DIN lever to lock it.
Excessive force may damage the DIN lever.

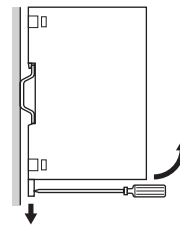

● Installing with screws

Install the speed controller through the mounting holes using two screws (No.8-32UNC or M4: not supplied).
[Tightening torque: 0.7 N·m (6.1 lb-in)]
Use screws and washers, which sizes are Ø10 mm (0.39 in.) or less, to secure the speed controller.

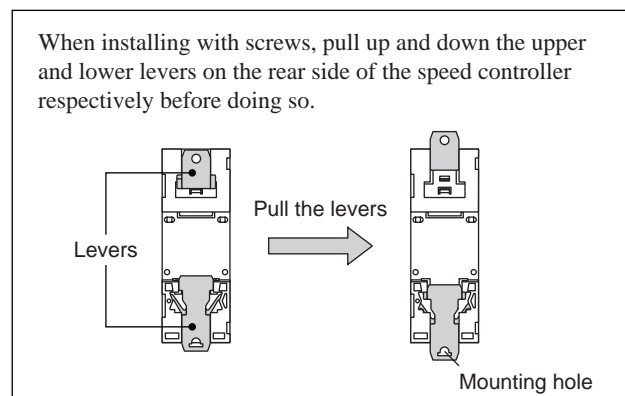
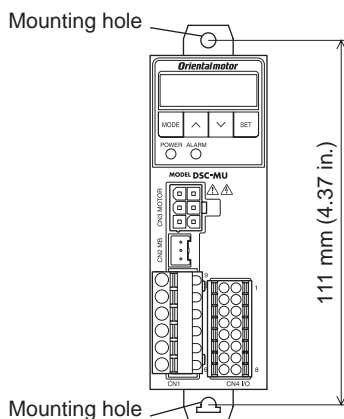

4.6 Installing the capacitor

Mount the capacitor securely using No.8-32UNC or M4 screw (not provided).

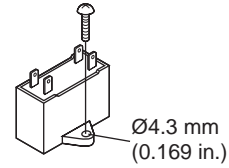

Note

- Do not let the screw fastening torque exceed 1 N·m (8.8 lb-in) to prevent damage to the mounting foot.
- Install the capacitor apart from the motor. If it is located closer, the capacitor life may be shortened due to the heat of the motor.

4.7 Installing an external potentiometer

When using an external potentiometer (supplied), install it as shown in the figure.

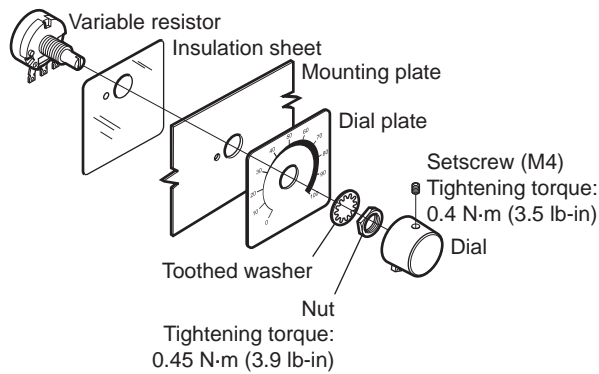

- Reference mounting hole dimensions [Unit: mm (in.)]

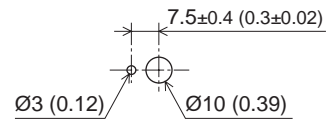

Soldering the variable resistor terminals and the lead wires

Cover a heat-shrinkable tube over the soldered part to insulate.

Soldering condition: 235 °C (455 °F), less than 5 sec

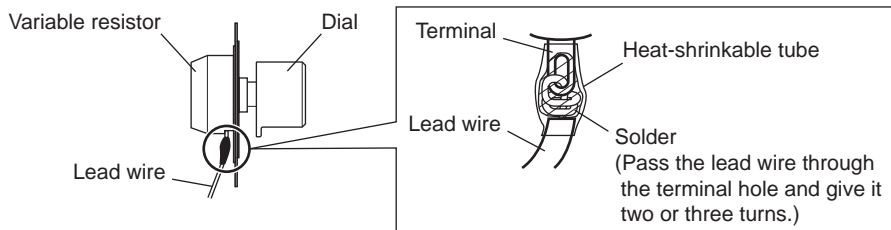

Refer to p.21 for connection of the external potentiometer.

5 Connection

This chapter explains how to connect the speed controller, power supply, motor and others.
When operating a motor, be sure to connect the control DC power supply in addition to the AC power supply.

5.1 Connecting method

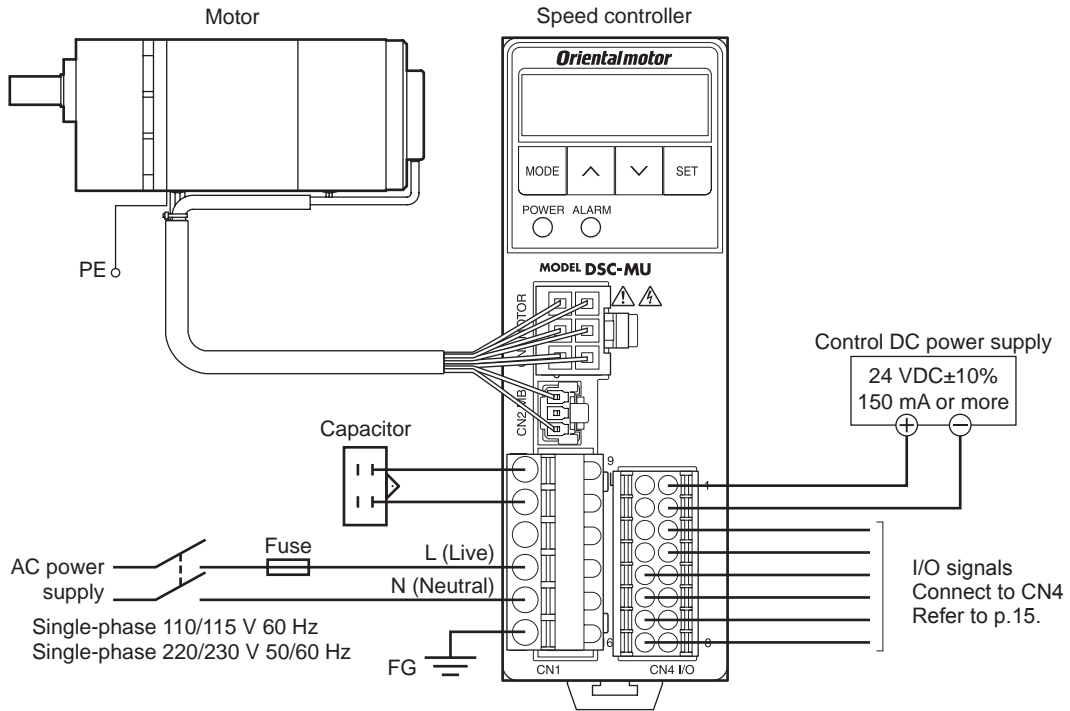

- Note**
- For the AC power supply voltage of the speed controller, be sure to use the same power supply voltage as the motor specification.
 - Ensure that the connector plugged in securely. Insecure connection may cause malfunction or damage to the motor or speed controller.

How to wiring the CN1 and CN4 connectors

Insert the lead wire while pushing the button of the orange color with a screwdriver.

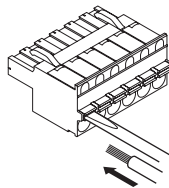

Manufacturer	PHOENIX CONTACT GmbH & Co. KG
Model	CN1: FKCT 2,5/6-ST-5,08 CN4: DFMC 1,5/8-ST-3,5

5.2 Connecting the AC power supply and capacitor

- Connect the AC power supply and capacitor to the CN1 on the speed controller.
- Applicable cable size: AWG18 to 14 (0.75 to 2.0 mm²)
 - Lead wire strip length: 10 mm (0.39 in.)

If crimp terminals are used, select the following terminals.

Manufacturer: PHOENIX CONTACT GmbH & Co. KG

Model: AI 0,75-10 [Conductor cross-sectional area: 0.65-0.82 mm² (AWG18)]

AI 1-10 [Conductor cross-sectional area: 0.82-1.2 mm² (AWG18)]

AI 1,5-10 [Conductor cross-sectional area: 1.25-1.8 mm² (AWG16)]

AI 2,5-10 [Conductor cross-sectional area: 2.0-3.0 mm² (AWG14)]

■ CN1 pin assignments

Pin No.	Connection	Description
1	Capacitor	Connects the capacitor.
2		
3	N.C.	Not connected.
4	AC power supply	Connects a live wire.
5		Connects a neutral wire.
6	FG	Connects a grounding wire.

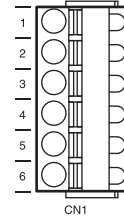

■ Connecting the capacitor

There are four terminals in the supplied capacitor, and the terminals A-B and C-D are internally connected as shown in the figure.

Connect either of the terminals A or B and either of the terminals C or D to the speed controller.

Use the supplied capacitor cap to insulate the capacitor terminal connection.

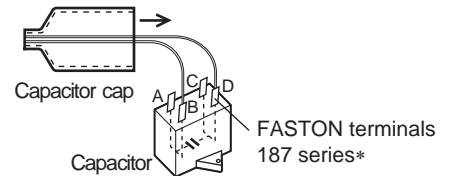

■ Connecting the earth leakage breaker

Install an earth leakage breaker to the AC power line to protect the primary circuit.

Recommended device Mitsubishi Electric Corporation: NV series

■ Connecting the fuse

Be sure to connect a fuse or similar device in the AC power line to protect against overcurrent.

Fuse rating	Single-phase 110/115 V	216 Series (Littelfuse, Inc.) 10 A or equivalent
	Single-phase 220/230 V	216 Series (Littelfuse, Inc.) 6.3 A or equivalent

5.3 Connecting the motor and speed controller

Connect the motor cable connector to the CN2 and CN3 on the speed controller.

Use a connection cable (supplied or accessory) when extending the wiring distance between the motor and speed controller. The connection cable can be connected up to 3 pieces. The wiring distance between the motor and speed controller can be extended to a maximum of 10.5 m (34.4 ft.).

Flexible connection cables are also available as accessories.

Note Ensure that the connector is plugged in securely. Insecure connection may cause malfunction or damage to the motor or speed controller.

5.4 Grounding the motor

Ground close to the motor at a shortest distance using the Protective Earth Terminal of the motor (⊕).

Applicable crimp terminal: Insulated round crimp terminal

Terminal screw size: M4

Tightening torque: 1.0 to 1.3 N·m (8.8 to 11.5 lb-in)

Applicable lead wire: AWG18 (0.75 mm²) or thicker

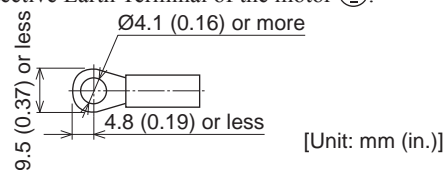

Note Do not use screws other than the Protective Earth Terminal screw attached on the product.

5.5 Connecting the control DC power supply and I/O signals

Connect the control power supply and I/O signals to the CN4.

For the control DC power supply, use a power supply with reinforced insulation on its primary and secondary sides.

- Applicable cable size: AWG24 to 18 (0.2 to 0.75 mm²)
- Lead wire strip length: 10 mm (0.39 in.)

If crimp terminals are used, select the following terminals.

Manufacturer: PHOENIX CONTACT GmbH & Co. KG

Model: AI 0,25-10 [Conductor cross-sectional area: 0.14-0.34 mm² (AWG24)]

AI 0,34-10 [Conductor cross-sectional area: 0.14-0.34 mm² (AWG22)]

AI 0,5-10 [Conductor cross-sectional area: 0.40-0.65 mm² (AWG20)]

AI 0,75-10 [Conductor cross-sectional area: 0.65-0.82 mm² (AWG18)]

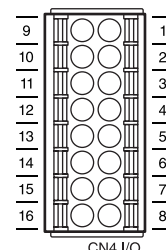

■ CN4 pin assignments

Pin No.	Signal name	Function *1	Description
1	+24 V	Control DC power supply	Connect the 24 VDC power supply for control circuit.
2	0 V [GND]		
3	IN0	[FWD]	The motor rotates in the forward direction while this signal is being "ON."*2
4	IN1	[REV]	The motor rotates in the reverse direction while this signal is being "ON."*2
5	IN2	[M0]	These signals are used to select the operation data number.
6	IN3	[M1]	
7	IN4	[ALARM-RESET]	This signal is used to reset the alarm.
8	IN5	[FREE]	If the FREE input is turned "ON," the electromagnetic brake will be released. If the FWD input or REV input is turned "ON" while the FREE input is being ON, the motor will not rotate. If the FREE input is turned "ON" while the motor is operating, the motor will coast to a stop.
9	VH	External speed setting input	Connects when the rotation speed is set externally using the external potentiometer or external DC voltage. (Refer to p.21.)
10	VM		
11	VL		
12	N.C.	-	Not connected.
13	OUT0+	[SPEED-OUT]	12 pulses are output with each revolution of the motor output shaft.
14	OUT0-		
15	OUT1+	[ALARM-OUT]	This signal is output when an alarm generates (normally closed).
16	OUT1-		

*1 The signal in brackets [] is a function that is assigned at the time of shipment. Refer to p.34 for the signals that can be assigned.

*2 The rotation direction varies depending on the gear ratio of the gearhead or the setting of the parameter. Refer to p.22 for details.

• Connection example for I/O signals

This is a connection example for when the product is operated using relays, switches and other contact switches with the sink logic setting.

If the product is operated or stopped using a programmable controller, refer to p.17 for when using with the source logic setting.

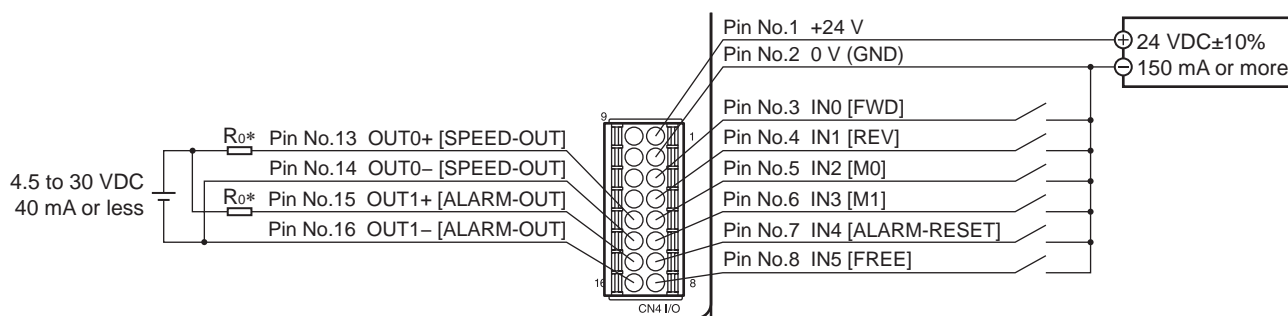

* Recommended resistance value
 24 VDC: 680 Ω to 4.7 kΩ (2 W)
 5 VDC: 150 Ω to 1 kΩ (0.5 W)

Connect a current-limiting resistor R_0 according to the power supply voltage so that the current flowing through the output signal will not exceed 40 mA.

Internal circuit configuration of signal input part

All input signals of the speed controller are photocoupler inputs.

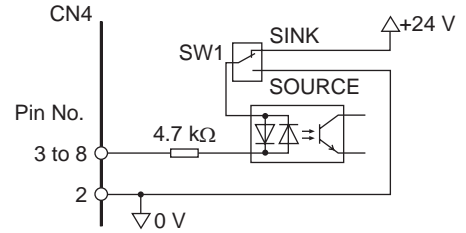

Internal circuit configuration of signal output part

All output signals of the speed controller are photocoupler/open-collector output.
 The ON voltage of the output circuit is 1.6 VDC maximum.
 When driving each element using the output signal circuit, give consideration to this ON voltage.
 External power supply: 4.5 to 30 VDC, 40 mA or less

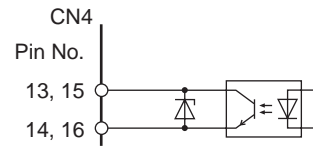

- Note**
- Always connect a current-limiting resistor. If the external power supply is connected to the output circuit directly without connecting a current-limiting resistor, the speed controller will be damaged.
 - When connecting a relay (inductive load), etc., to detect alarm outputs, use a relay with built-in flywheel diode, or provide a fly-back voltage control measure based on diode, etc., for the inductive load.

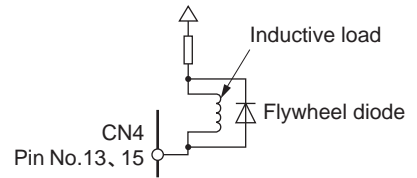

Using external control equipment with a built-in clamp diode

If external control equipment with a built-in clamp diode is used, a leakage path may form and cause the motor to operate even when the external control equipment power is off, as long as the speed controller power is on. Since the power capacity of the external control equipment is different from that of the speed controller, the motor may operate when the external control equipment and speed controller powers are turned on or off simultaneously. When powering down, turn off the speed controller power first, followed by the external control equipment power. When powering up, turn on the external control equipment power first, followed by the speed controller power.

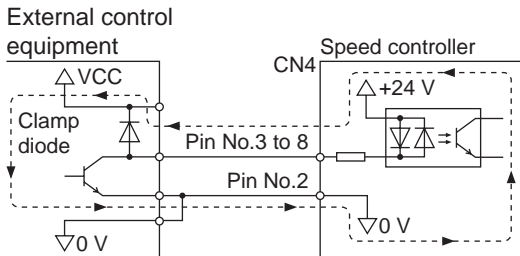

5.6 Connection example for I/O signals and programmable controller

Set the input logic to the "sink logic" side or "source logic" side in accordance with the programmable controller used with the speed controller.
 It is set using the SW1 as shown in the figure.
 Sink logic (SINK) is set at the time of shipment.
 When using with source logic, switch to the SOURCE side.

Figure seen from the lower face of the speed controller

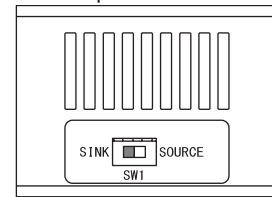

Sink Logic (SINK)

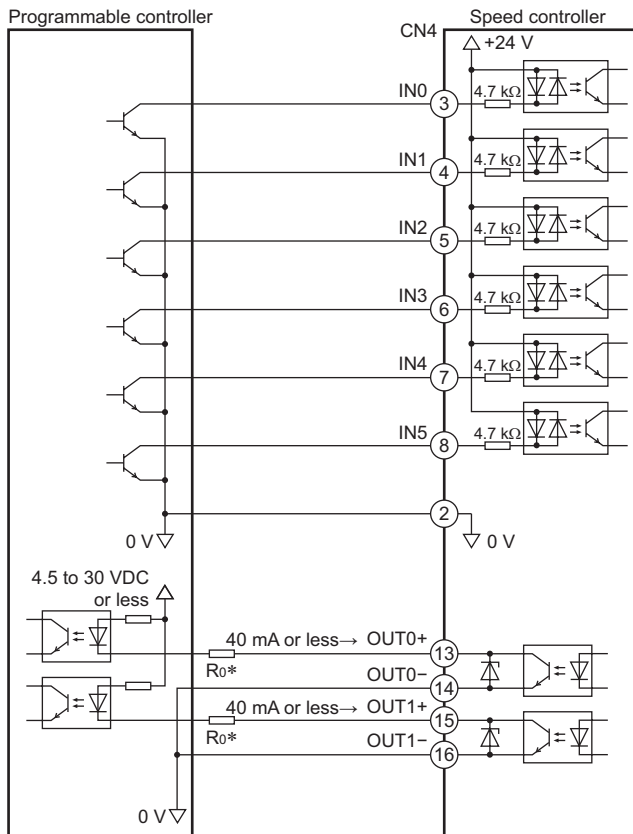

Source Logic (SOURCE)

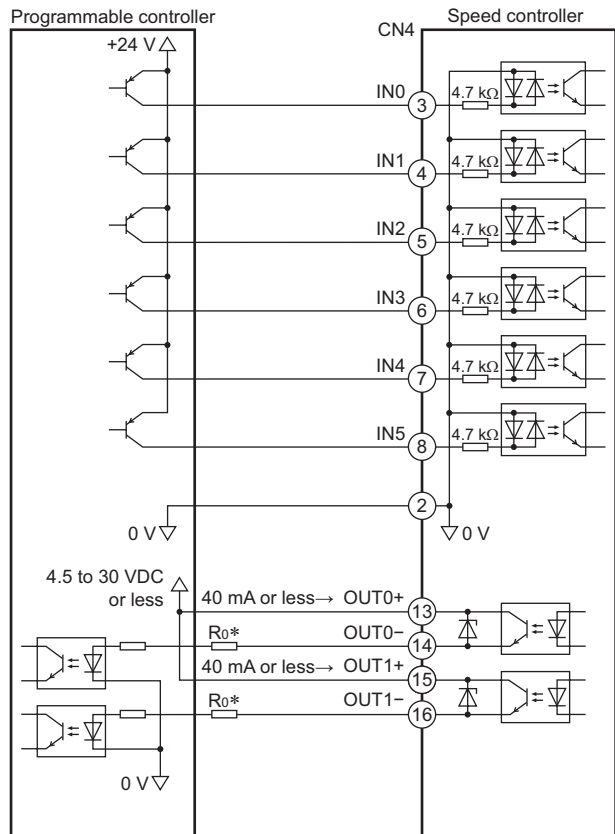

* Recommended resistance value
 24 VDC: 680 Ω to 4.7 kΩ (2 W)
 5 VDC: 150 Ω to 1 kΩ (0.5 W)

- Note**
- For the voltage connecting to output signals, use between 4.5 and 30 VDC.
 - Be sure to use the current of the OUT0 and OUT1 at 40 mA or less. Connect a current-limiting resistor R_0 if the current exceeds 40 mA.

6 Operation

This product can be used for a vertical operation such as elevating equipment in addition to a horizontal operation such as conveyor transportation.

Vertical operation

When using the motor in an application that a load is driven vertically or the motor output shaft is forcibly rotated by a load as shown in the figure, use in the following operating conditions. Refer to p.24 "6.9 Operating in vertical direction" for details.

Operating condition	
Speed setting range	50 Hz: 300 to 1400 r/min 60 Hz: 300 to 1600 r/min
Acceleration/deceleration time setting range	0.2 to 15.0 seconds
Parameter setting	"Deceleration control" parameter: Enable (Initial value) "Brake type" parameter: Deceleration stop (Initial value)
Load condition	Less than the permissible torque in a vertical operation. Refer to the product catalog for details.
Operating cycle	Motors of 15 W to 90 W have a limitation. Refer to "6.7 Operating cycle" on p.23 for details.

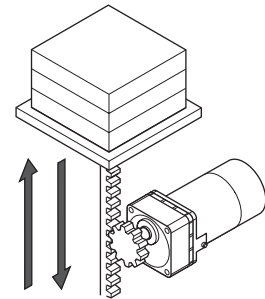

Horizontal operation

When using the motor in a horizontal operation as shown in the figure, the rotation speed can be used at the setting speed from 90 r/min.

Speed setting range	50 Hz: 90 to 1400 r/min 60 Hz: 90 to 1600 r/min
---------------------	--

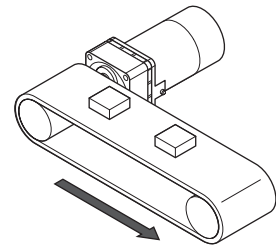

If the "deceleration control" parameter is set to OFF, the motor starting characteristics or the setting range of the acceleration/deceleration time will be changed in addition to the setting range of the rotation speed. Refer to "Setting the deceleration control" on p.33 for details.

6.1 Power ON

Turn on the power after completing the connection. Refer to p.13 for connection.

Turning on the AC power supply → POWER LED (Green) lit
Turning on the DC power supply →  display

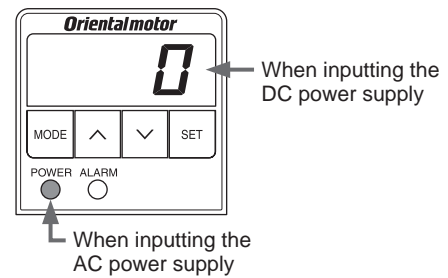

Note When the power is turned on, if the FWD input or REV input is being ON, the alarm code "AL 45" (prevention of operation at power-on) is displayed and the operation cannot be executed. Before supplying the power, turn both the FWD and REV inputs OFF.

Refer to p.35 for "prevention of operation at power-on."

■ Test operation

The connection between the motor and speed controller can be checked.
 When performing test operation, do not install a load to the motor.
 The rotation speed in test operation is 300 r/min.

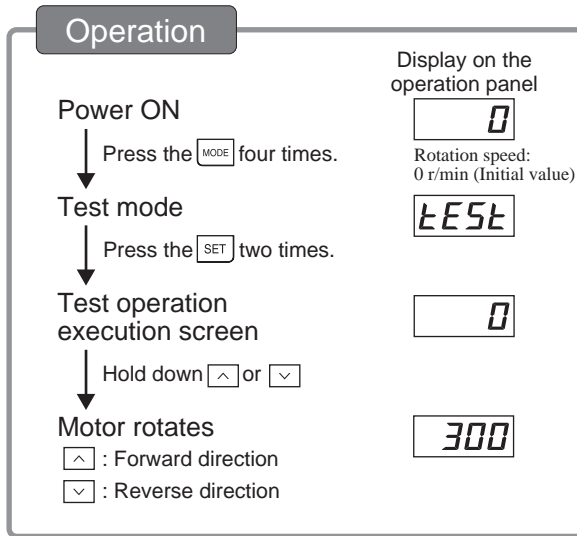

Before moving to the execution screen, if the FWD input or REV input is being ON, "Err" will be displayed.

The rotation direction of the gearhead output shaft varies depending on the gear ratio of the gearhead. Refer to p.22 for details.

Note Test operation cannot be executed if the FREE input is being ON. Be sure to execute after turning the signal OFF.

■ Releasing the electromagnetic brake

The electromagnetic brake can be released using the operation panel while the motor stops.
 Refer to p.34 for details.

6.2 Starting, stopping

When either of the FWD input or REV input is turned ON after setting the rotation speed, the motor will rotate at the specified speed.

If the signal (FWD input or REV input) which has been turned ON is turned OFF while the motor is rotating, the motor will decelerate to a stop based on the specified deceleration time.

If the FWD input and REV input are turned ON simultaneously, the motor stops instantaneously.

FWD input	REV input	Motor shaft action
ON	OFF	Rotates in the forward direction
OFF	ON	Rotates in the reverse direction
OFF	OFF	Deceleration stop *
ON	ON	Instantaneous stop

* It can be changed to "coasting stop" using "brake type" parameter. Refer to p.33 for details.

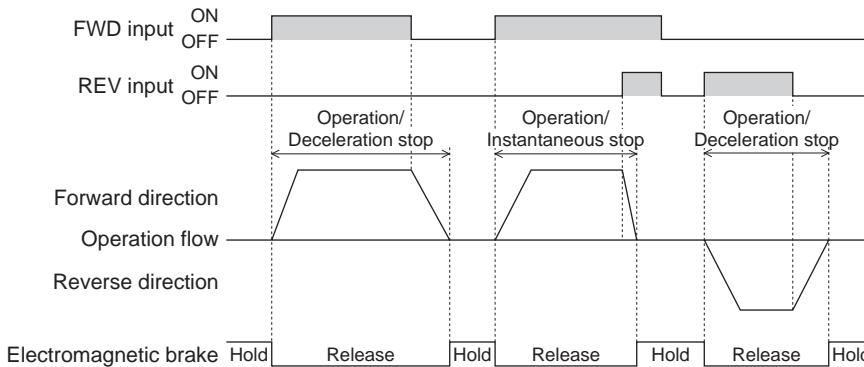

If a vertical operation is performed, check the operating conditions referring to "6.9 Operating in vertical direction" on p.24 before starting or stopping the motor.

Note Make sure that the motor case temperature does not exceed 90 °C (194 °F) during operation of the motor. Operation exceeding case temperature 90 °C (194 °F) may significantly deteriorate the coils and ball bearings of the motor and shorten the motor's life span.

6.3 Setting the rotation speed

The rotation speed can be set using any of the following method (1), (2) or (3).

The rotation speed of the gearhead output shaft varies depending on the gear ratio. This manual describes the rotation speed of the motor output shaft.

Setting range 50 Hz: 300* to 1400 r/min * When the "deceleration control" parameter is set to ON. If the "deceleration control" parameter is set to OFF, the speed can be set from 90 r/min.
 60 Hz: 300* to 1600 r/min

If the product is operated at 50 Hz when the rotation speed exceeding 1400 r/min has been set, the motor will rotate around 1420 r/min although it is out of the setting range.

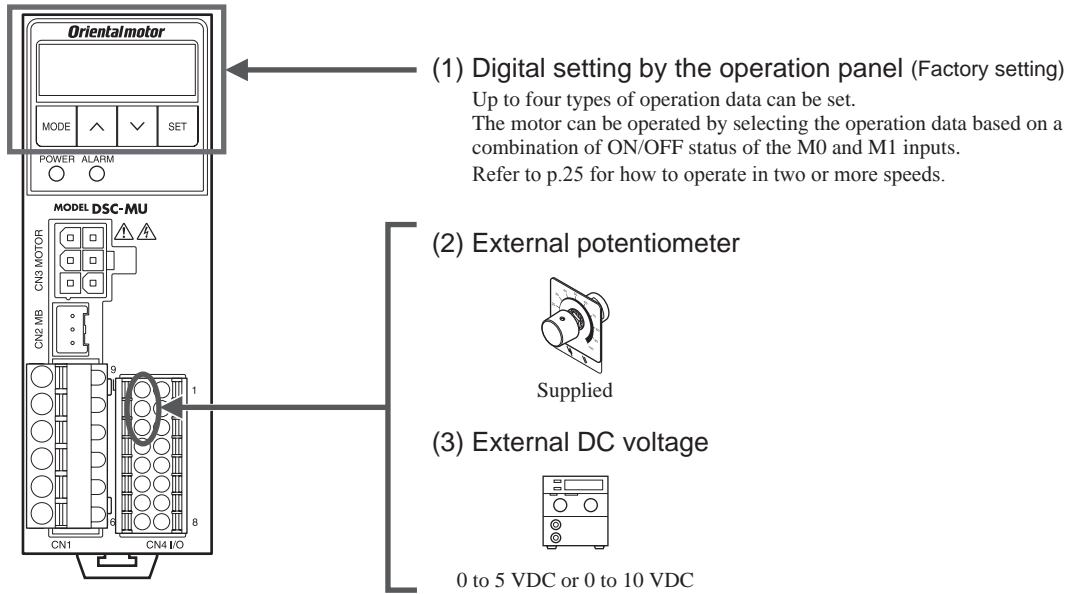

■ Setting method using the operation panel

The rotation speed can be set while rotating the motor, and it can also be set in the motor standstill state. This section explains as an example for how to set the rotation speed while rotating the motor.

Example: Set the rotation speed to 1000 r/min from 0 r/min

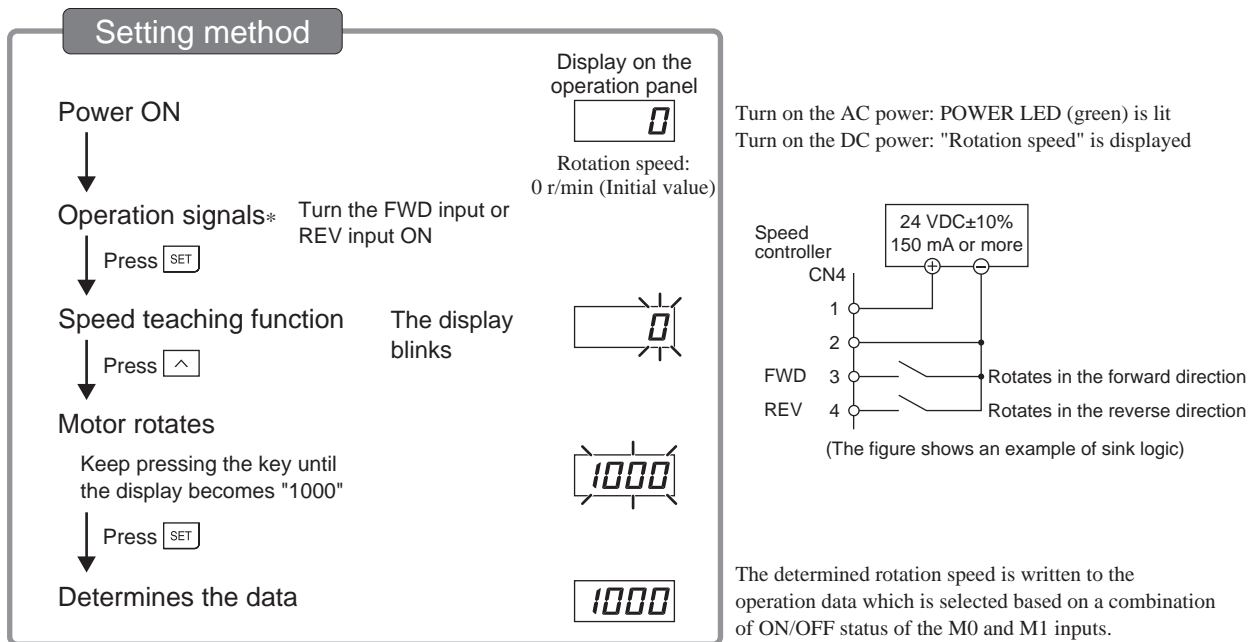

* If the rotation speed is already set, the motor rotates.

If both the FWD input and REV input are turned OFF, the rotation speed can be set in a state of motor standstill.

Remote setting method

The rotation speed can also be set remotely by the following two methods. Set the "external speed command input" parameter to "ON (Enable)" (initial value: OFF), and turn the M0 input and M1 input OFF. The setting range of the rotation speed varies depending on the setting of the "deceleration control" parameter. Refer to p.31 for how to set the parameter.

• **Setting with external potentiometer (supplied or sold separately).**

Connect the external potentiometer to the CN4.
Turn the external potentiometer clockwise to increase the speed.

External speed command voltage selection parameter: "0 to 5" (initial value)

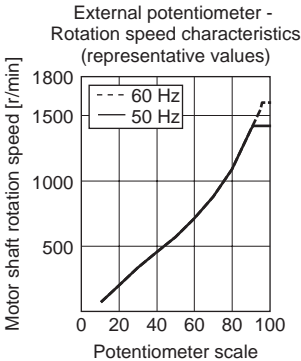
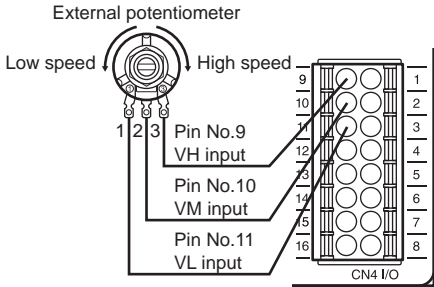

• **Setting with external DC voltage**

Connect an external DC power supply (0 to 5 VDC or 0 to 10 VDC) with reinforced insulation on its primary and secondary sides to the CN4.

"External speed command voltage selection" parameter:
"0 to 5" (initial value) for 0 to 5 VDC
"0 to 10" for 0 to 10 VDC

The input impedance between the VM input and VL input is approximately 11.3 kΩ.

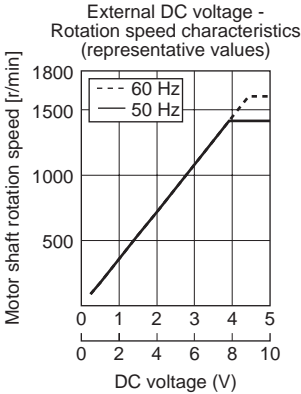
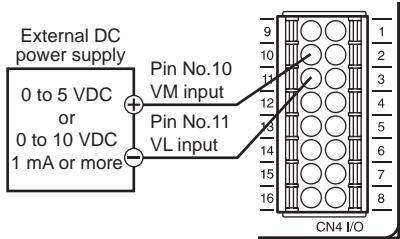

Note Be sure to set the external DC voltage to 10 VDC or less. When connecting the external DC power supply, make sure the polarities are correct. If the polarities are reversed, the speed controller may be damaged.

6.4 Setting the acceleration time and deceleration time

The acceleration time and deceleration time can be adjusted to prevent the load from receiving a shock upon starting, stopping, or a change in speed. Refer to p.28 for how to set each operation data using the operation panel. The setting range of the deceleration time or the operation of the deceleration stop varies depending on the setting of the "deceleration control" parameter. Refer to p.33 for details.

Setting range: 0.2 to 15.0 seconds *
* When the "deceleration control" parameter is set to ON. If the "deceleration control" parameter is set to OFF, the setting range will be 0.0 to 15.0 seconds.

The actual acceleration time and deceleration time against the setting vary depending on the load inertia, frictional load, set rotation speed or motor output power.

The setting method of the acceleration time and deceleration time varies depending on the setting method of the rotation speed.

• **When the rotation speed is set by the operation panel**

Set the time needed to reach the target speed from the present speed.

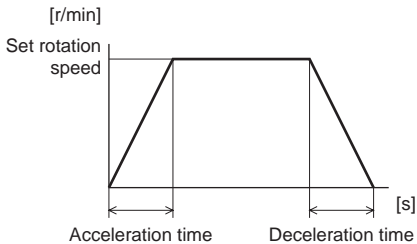

• **When the rotation speed is set remotely**

Set as the time needed for the motor to reach 1000 r/min from the standstill state.

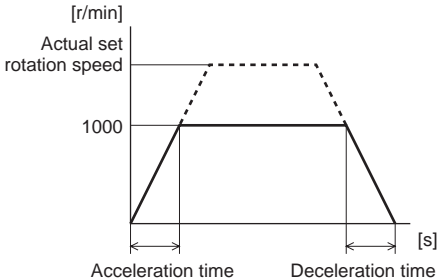

6.5 Motor rotation direction

- The rotation direction shown in the figure below is as viewed from the motor output shaft.
- The rotation direction of the gearhead output shaft varies depending on the gear ratio of the gearhead. Use the FWD input or REV input according to the gear ratio of the gearhead.

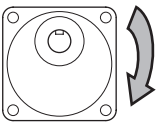
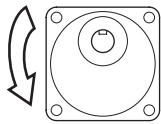
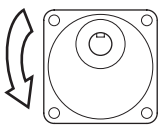
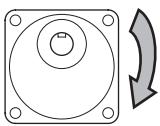
Motor output power		Gear ratio	
6 W, 15 W, 25 W		7.5 to 25 150 to 360	30 to 120
40 W, 60 W		7.5 to 18 120 to 300	25 to 100
90 W		7.5 to 15 75 to 180	18 to 60
Rotation direction	FWD input signal	Clockwise 	Counterclockwise 
	REV input signal	Counterclockwise 	Clockwise 

The rotation direction of the motor output shaft which rotates when the FWD input is turned ON can be changed with the "motor rotation direction" parameter. Refer to p.31 for details.

6.6 Timing chart

This is an example of a timing chart.

Example: 1200 r/min is set in the operation data No.0 and 300 r/min is set in the operating data No.1.

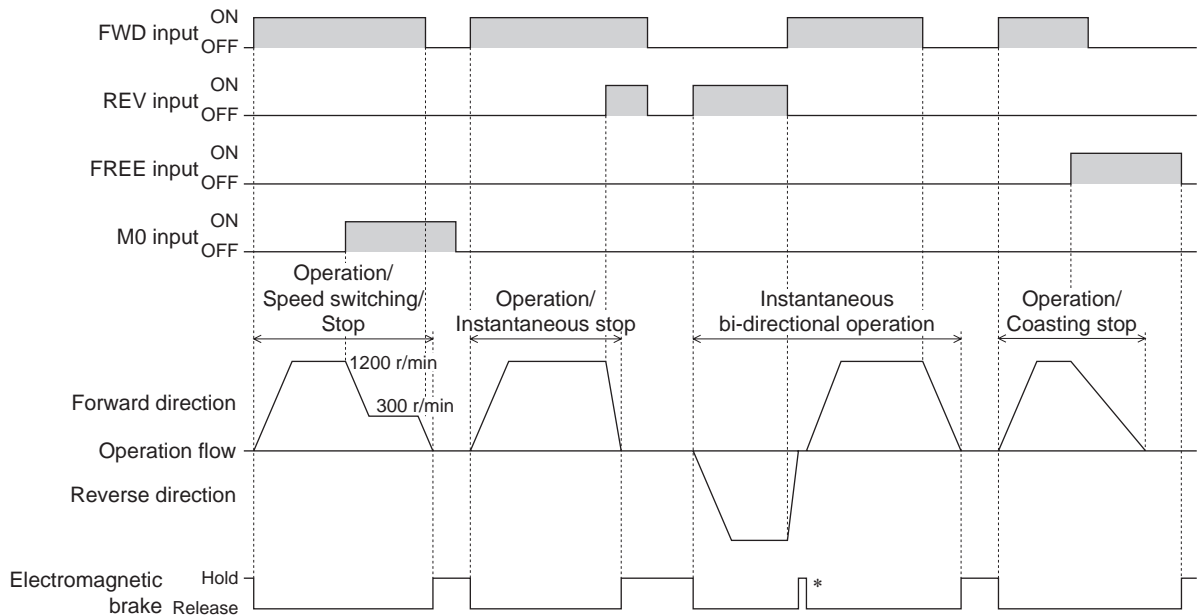

* When the "deceleration control" parameter is set to ON, the electromagnetic brake holds (about 0.1 sec). If it is set to OFF, the electromagnetic brake will not hold.

Note Make sure each signal remains ON for at least 10 ms.

6.7 Operating cycle

If operations such as running and instantaneous stop or instantaneous rotation direction changes are repeated in a short cycle time, the motor temperature rise will be large, and the operating time may be limited. Use the motor by reference to the followings.

Operation/Instantaneous stop			Instantaneous bi-directional operation																										
<p>Motor movement</p>			<p>Motor movement</p>																										
<p>Conditions of use</p> <div style="display: flex; justify-content: space-between;"> <div style="width: 45%;"> <p>[6 W to 40 W]</p> <ul style="list-style-type: none"> • Operating cycle: 2 seconds or more • Operating duty: 50% or less </div> <div style="width: 45%;"> <p>[60 W, 90 W]</p> <ul style="list-style-type: none"> • Operating cycle: 4 seconds or more • Operating duty: 50% or less </div> </div>			<p>Conditions of use</p> <div style="display: flex; justify-content: space-between;"> <div style="width: 45%;"> <p>[6 W to 40 W]</p> <p>Rotation direction switching: Once in every 2 seconds or more</p> </div> <div style="width: 45%;"> <p>[60 W, 90 W]</p> <p>Rotation direction switching: Once in every 4 seconds or more</p> </div> </div>																										
<p>Example</p> <table border="1" style="width:100%; border-collapse: collapse;"> <thead> <tr> <th>Use</th> <th>Operation/Stop</th> <th>Operating duty</th> </tr> </thead> <tbody> <tr> <td style="text-align: center;">○</td> <td>1 second/ 1 second</td> <td style="text-align: center;">50%</td> </tr> <tr> <td style="text-align: center;">○</td> <td>0.5 seconds/ 1.5 seconds</td> <td style="text-align: center;">25%</td> </tr> <tr> <td style="text-align: center;">×</td> <td>1.2 seconds/ 0.8 seconds</td> <td style="text-align: center;">60%</td> </tr> </tbody> </table>			Use	Operation/Stop	Operating duty	○	1 second/ 1 second	50%	○	0.5 seconds/ 1.5 seconds	25%	×	1.2 seconds/ 0.8 seconds	60%	<p>Example</p> <table border="1" style="width:100%; border-collapse: collapse;"> <thead> <tr> <th>Use</th> <th>Operation/Stop</th> <th>Operating duty</th> </tr> </thead> <tbody> <tr> <td style="text-align: center;">○</td> <td>2 seconds/ 2 seconds</td> <td style="text-align: center;">50%</td> </tr> <tr> <td style="text-align: center;">○</td> <td>1.2 seconds/ 2.8 seconds</td> <td style="text-align: center;">30%</td> </tr> <tr> <td style="text-align: center;">×</td> <td>3 seconds/ 1 second</td> <td style="text-align: center;">75%</td> </tr> </tbody> </table>			Use	Operation/Stop	Operating duty	○	2 seconds/ 2 seconds	50%	○	1.2 seconds/ 2.8 seconds	30%	×	3 seconds/ 1 second	75%
Use	Operation/Stop	Operating duty																											
○	1 second/ 1 second	50%																											
○	0.5 seconds/ 1.5 seconds	25%																											
×	1.2 seconds/ 0.8 seconds	60%																											
Use	Operation/Stop	Operating duty																											
○	2 seconds/ 2 seconds	50%																											
○	1.2 seconds/ 2.8 seconds	30%																											
×	3 seconds/ 1 second	75%																											
<p>Example</p> <table border="1" style="width:100%; border-collapse: collapse;"> <thead> <tr> <th>Use</th> <th>Rotation direction switching</th> </tr> </thead> <tbody> <tr> <td style="text-align: center;">○</td> <td>Forward: 2 seconds Reverse: 3 seconds</td> </tr> <tr> <td style="text-align: center;">×</td> <td>Forward: 2 seconds Reverse: 1 second</td> </tr> </tbody> </table>			Use	Rotation direction switching	○	Forward: 2 seconds Reverse: 3 seconds	×	Forward: 2 seconds Reverse: 1 second	<p>Example</p> <table border="1" style="width:100%; border-collapse: collapse;"> <thead> <tr> <th>Use</th> <th>Rotation direction switching</th> </tr> </thead> <tbody> <tr> <td style="text-align: center;">○</td> <td>Forward: 4 seconds Reverse: 6 seconds</td> </tr> <tr> <td style="text-align: center;">×</td> <td>Forward: 4 seconds Reverse: 2 seconds</td> </tr> </tbody> </table>			Use	Rotation direction switching	○	Forward: 4 seconds Reverse: 6 seconds	×	Forward: 4 seconds Reverse: 2 seconds												
Use	Rotation direction switching																												
○	Forward: 2 seconds Reverse: 3 seconds																												
×	Forward: 2 seconds Reverse: 1 second																												
Use	Rotation direction switching																												
○	Forward: 4 seconds Reverse: 6 seconds																												
×	Forward: 4 seconds Reverse: 2 seconds																												

Note Make sure that the motor case temperature does not exceed 90 °C (194 °F) when operating the motor. Operation exceeding case temperature 90 °C (194 °F) may significantly deteriorate the coils and ball bearings of the motor and shorten the motor's life span.

■ Limitation in vertical operation

If the motor is kept operating downward in vertical operation, the motor temperature rise will be large, and the operating time may be limited. The time that the motor can be used varies depending on the motor output power. (The 6 W type motors can be used continuously.)

Use in the area below ① and ② lines in the following figure.

Operation time-standstill time at vertical operation

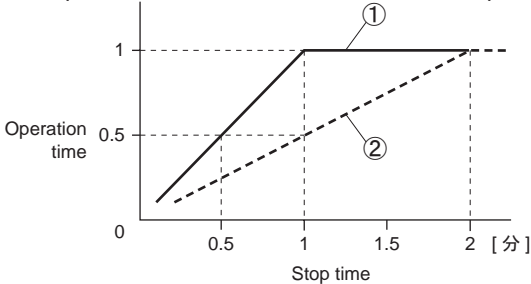

①: 15 W, 25 W, 40 W type

- Operating duty: 50% or less
- Continuous operation available time: 1 minute

②: 60 W, 90 W type

- Operating duty: 33% or less
- Continuous operation available time: 1 minute

Example
 Operation: 1 minute, stop: 1 minute
 Operation: 30 seconds, stop: 30 seconds

Example
 Operation: 1 minute, stop: 2 minutes
 Operation: 30 seconds, stop: 1 minute

$$\text{Operating duty} = \frac{\text{Operation time}}{\text{Operation time} + \text{Stop time}} \times 100 [\%]$$

6.8 Brake current

When performing motor operations such as instantaneous stop, instantaneous bidirectional operation, and vertical drive operation, a large braking current shown in the table flows in the AC power lines.

In the case of an operation of instantaneous stop, the braking current flows for 0.4 seconds to stop the motor.

For capacitances of a breaker and AC power supply in equipment, select in consideration of the braking current (peak value) in the table.

Motor output power	Brake current (peak value)	
	Single-phase 110/115 V	Single-phase 220/230 V
6 W	2 A	1 A
15 W	4 A	3 A
25 W	8 A	4 A
40 W	12 A	7 A
60 W	21 A	10 A
90 W	29 A	13 A

Note Do not turn off the power supply while the braking current is flowed. Doing so may damage to the speed controller.

6.9 Operating in vertical direction

This product can be used in the mechanism of vertical operation such as elevating equipment. Check the following conditions thoroughly before using the product.

■ Notes about vertical operation

- If the product is used in vertical operation, provide the safety device for anti-drop mechanism in equipment side.
- Do not use the brake mechanism of the electromagnetic brake motor as a safety brake.
- Do not turn the FREE input ON.
If the FREE input is turned ON, the holding force of the electromagnetic brake is lost and the load may fall.
- Operate the product after thoroughly checking the load condition.
If a load exceeding the conditions that can operate is applied, the load may fall.

■ Conditions for vertical operation

- Speed setting range

50 Hz: 300 to 1400 r/min
60 Hz: 300 to 1600 r/min

- Acceleration/deceleration time setting range

0.2 to 15.0 seconds

- Parameter setting

"Deceleration control" parameter: "ON (enable)" (initial value)
"Brake type" parameter: "SD (deceleration stop)" (initial value)

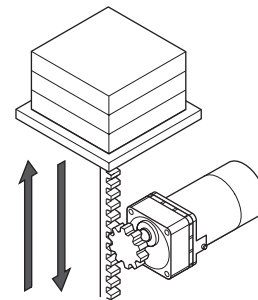

Note

- Do not set the "deceleration control" parameter to OFF.
If this parameter is set to OFF, the speed cannot be controlled when operating downward, causing the load to fall.
- Do not set the "brake type" parameter to "coasting stop."
If this parameter is set to "coasting stop," the load may fall when the motor stops.

- Load condition

Note that the load does not exceed the permissible torque for vertical operation. Refer to the product catalog for details.

- Operating cycle

Refer to p.23 for operating cycle.

Reference

When using the motor in a vertical operation, the following motor action may occur depending on the setting or load condition.

Refer to "9 Troubleshooting and remedial actions" on p.37 for other phenomena.

- **The motor vibration is large.**

Possible cause	Remedial action
The motor speed fluctuation is large.	Check the load condition.
	Check the rotation speed

- **The motor rotates in the reverse direction.**

Possible cause	Remedial action
The motor output shaft is rotated in the reverse direction when moving up because the load exceeding the conditions has been operated.	Check the load condition.
The motor output shaft is rotated by sudden load fluctuations.	Reduce the load fluctuation.

6.10 Operating in two or more speed (multi-speed operation)

The multi-speed operation can be performed by setting the rotation speed and switching the ON/OFF status of the M0 and M1 inputs.

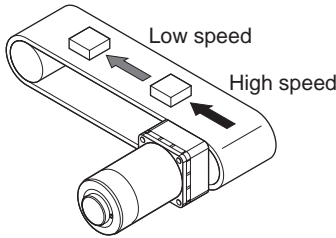

■ Data setting method (Example: Rotation speed)

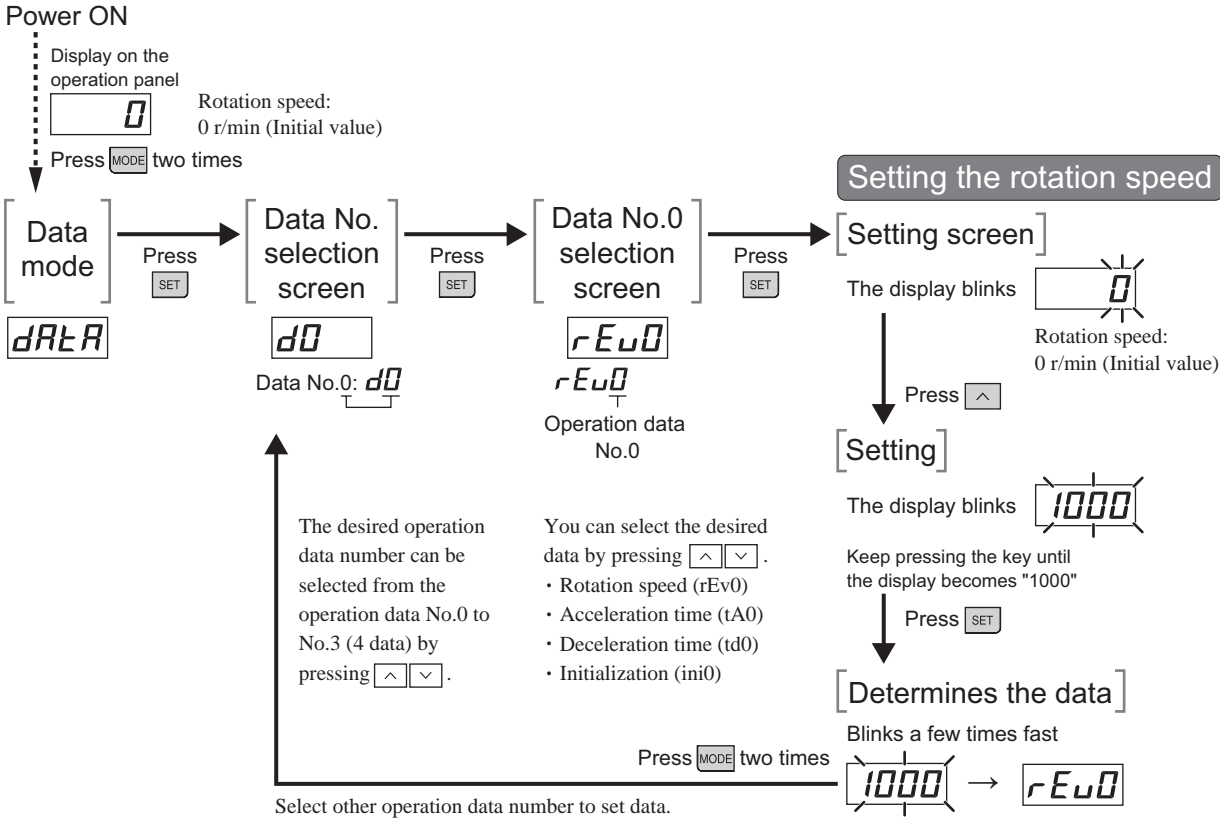

Refer to "7.2 Setting items and panel displays" on p.28 and p.29 for panel transitions.

■ Operating method

Operate the motor by selecting any of the operation data No.0 to No.3 based on a combination of ON/OFF status of the M0 and M1 inputs.

The motor is operated using the rotation speed, acceleration time, and deceleration time in the selected operation data number.

- « Operation procedure »
1. Select the operation data number using the M0 and M1 inputs.
 2. When either of the FWD input or REV input is turned ON, the motor will rotate.
 3. Switch the operation data number using the M0 and M1 inputs.
 4. When the FWD input or REV input which has been turned ON is turned OFF, the motor will stop.

Operation data No.	M1	M0	Description
0	OFF	OFF	Operation panel setting/ remote setting *
1	OFF	ON	Operation panel setting
2	ON	OFF	
3	ON	ON	

* When the "external speed command input" parameter is set to "ON (Enable)" (initial value: OFF), the rotation speed can be set using an external potentiometer or external DC voltage.

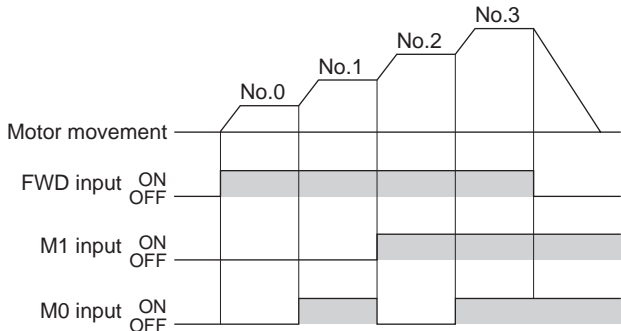

6.11 Adjusting the rotation speed of two or more motors by a single speed setter (multi-motor control)

Two or more motors can be operated at the same speed using a single variable resistor or external DC voltage. Set the "external speed command input" parameter to "ON (Enable)," and turn the M0 input and M1 input OFF. Refer to p.31 for parameters.

■ Adjusting the rotation speed using a variable resistor

Connect the speed controller as shown below.

When performing multi-motor control using the variable resistor, the number of speed controllers should not exceed 20 units.

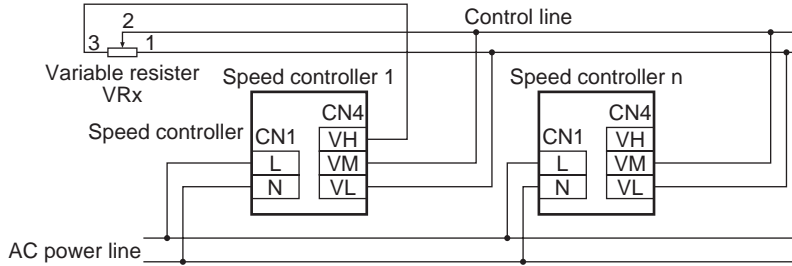

Resistance (VRx) when the number of speed controllers is n:

Resistance (VRx) = 20/n (kΩ), permissible dissipation = n/4 (W)

Example: If two speed controllers are used

Resistance = 20/2 = 10 (kΩ), permissible dissipation = 2/4 = 1/2 (W)

■ Adjusting the rotation speed using external DC voltage

Connect the speed controller as shown below.

The number of connected units may limit depending on the current capacity of the external DC power supply.

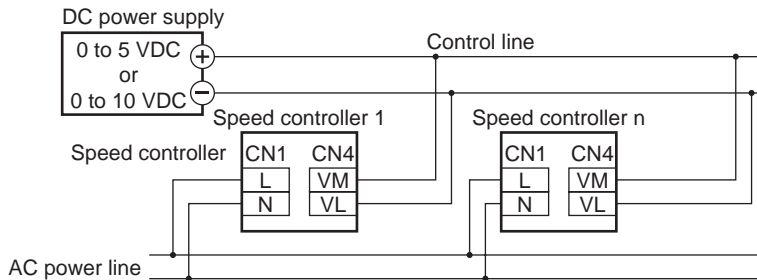

Current capacity (I) of external DC power supply when the number of speed controllers is n:

Current capacity (I) = 1 × n (mA)

Example: If two speed controllers are used

Current capacity (I) = 1 × 2 = 2 (mA)

■ Adjusting the speed difference

To adjust the speed difference among the first motor and the second and subsequent motors, change the "external speed command offset" parameter of the speed controller. Refer to p.31 for parameters.

The speed difference can be adjusted by changing the "setting voltage - rotation speed characteristics" shown in the figure.

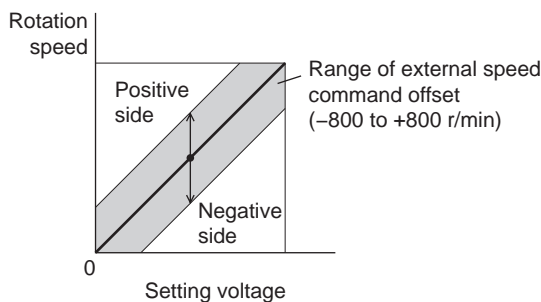

< Example >

- When the speed of the second motor is slower than that of the first motor, set the value for the positive side (0 to +800 r/min) in the "external speed command offset" parameter of the second speed controller.

7 Function

7.1 Functions list

The following functions are available for this product.

Function	Description	Reference page
Rotation speed	Displays the rotation speed of the motor output shaft.	30
	Displays by the rotation speed of the gearhead output shaft.	
	Fixes the display of the lowest digit to "0."	
Other Speed	Displays by the transfer speed of the conveyor drive.	31
	Displays by the increased speed.	
Operation data No.	Displays the operation data number.	30
I/O signals	Checks the ON/OFF status of the input signals.	
	Checks the ON/OFF status of the output signals.	
Alarm	Checks the alarm information.	
	Checks the alarm records.	
Warning	Checks the warning information.	
	Checks the warning records.	
Setting the rotation speed	Sets the rotation speed.	30
	Sets to change the speed while the motor is rotating.	20
	Set the rotation speed using the external potentiometer.	21
	Set the rotation speed using the external DC voltage.	
	Selects the setting voltage of the rotation speed. (0 to 5 VDC or 0 to 10 VDC)	31
	Checks the setting value (voltage) from outside.	30
	Setting the acceleration/ deceleration time	
	Multi-speed operation	
Test operation	Operates in two or more speeds.	25
Releasing the electromagnetic brake	Releases the electromagnetic brake.	34
Alarm reset	Resets the alarm that is present.	30
Action for when the power is turned on	Starts or stops the motor by ON-OFF control of the AC power supply.	31
Offset setting	Adjusts the speed difference when performing multi-motor control.	26
Limiting the setting range	Limits the setting range of the rotation speed (upper limit, lower limit)	32
Changing the function for I/O signals	Changes the functions of the input signals (6 signals).	34
	Changes the functions of the output signals (2 signals).	
Deceleration control	Changes the setting of "enable/disable" for the deceleration control.	33
Stop mode selection	Changes the motor stopping method.	
Changing the rotation direction	Changes the rotation direction when the FWD input is turned ON.	31
"Motor lock" alarm	Changes the alarm detection time.	
Operation data	Initializes the operation data.	30
	Parameter	Initializes the parameter.
Operation lock function	Blocks so that the data will not be changed.	34

7.2 Setting items and panel displays

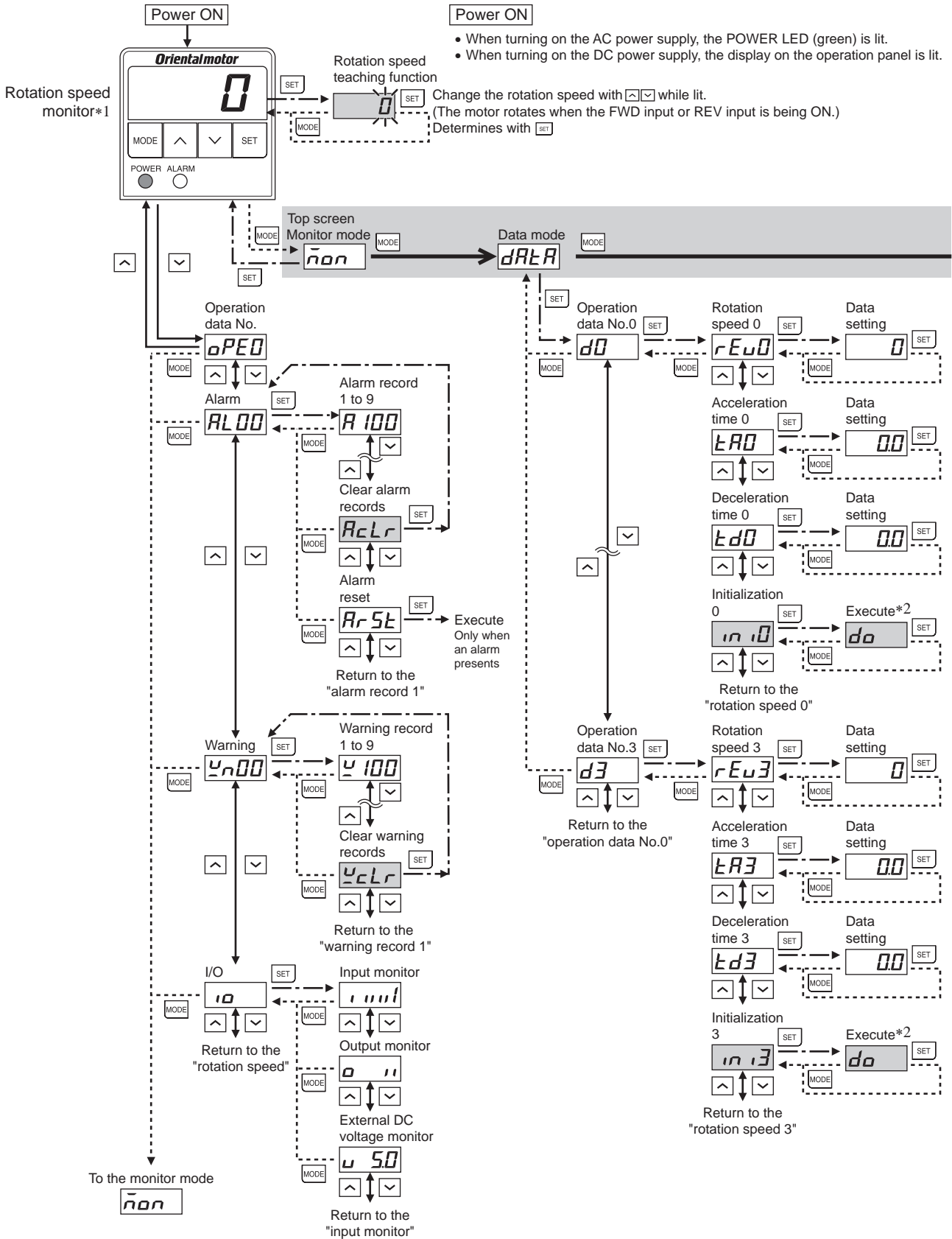

*1 When the speed reduction ratio or speed increasing ratio is being set, the converted speed is displayed.

*2 The setting change or execution is not possible while operating the motor. "Err" will be displayed.

• If operations are limited by the edit lock function, the screens in gray color are not displayed.

• The display blinks in the data setting screen. If \square SET is pressed after changing the setting, the display blinks fast (a few times) and the new setting will be determined.

Operation panel

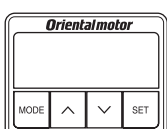

- MODE** : Switches the operation mode.
Moves to the upper level.
- ^** **v** : Changes the setting value.
- SET** : Determines the data.
Moves to the lower level.

Edit lock function

The operation panel can be locked so that the data cannot be changed. Perform the following action on the top screen.

- Lock *: Press and hold **MODE** for 5 seconds **Lk**
- Reset: Press and hold **MODE** for 5 seconds **UnLk**

*When editing the data or parameter while locking, "Lk" is displayed for about 1 second.

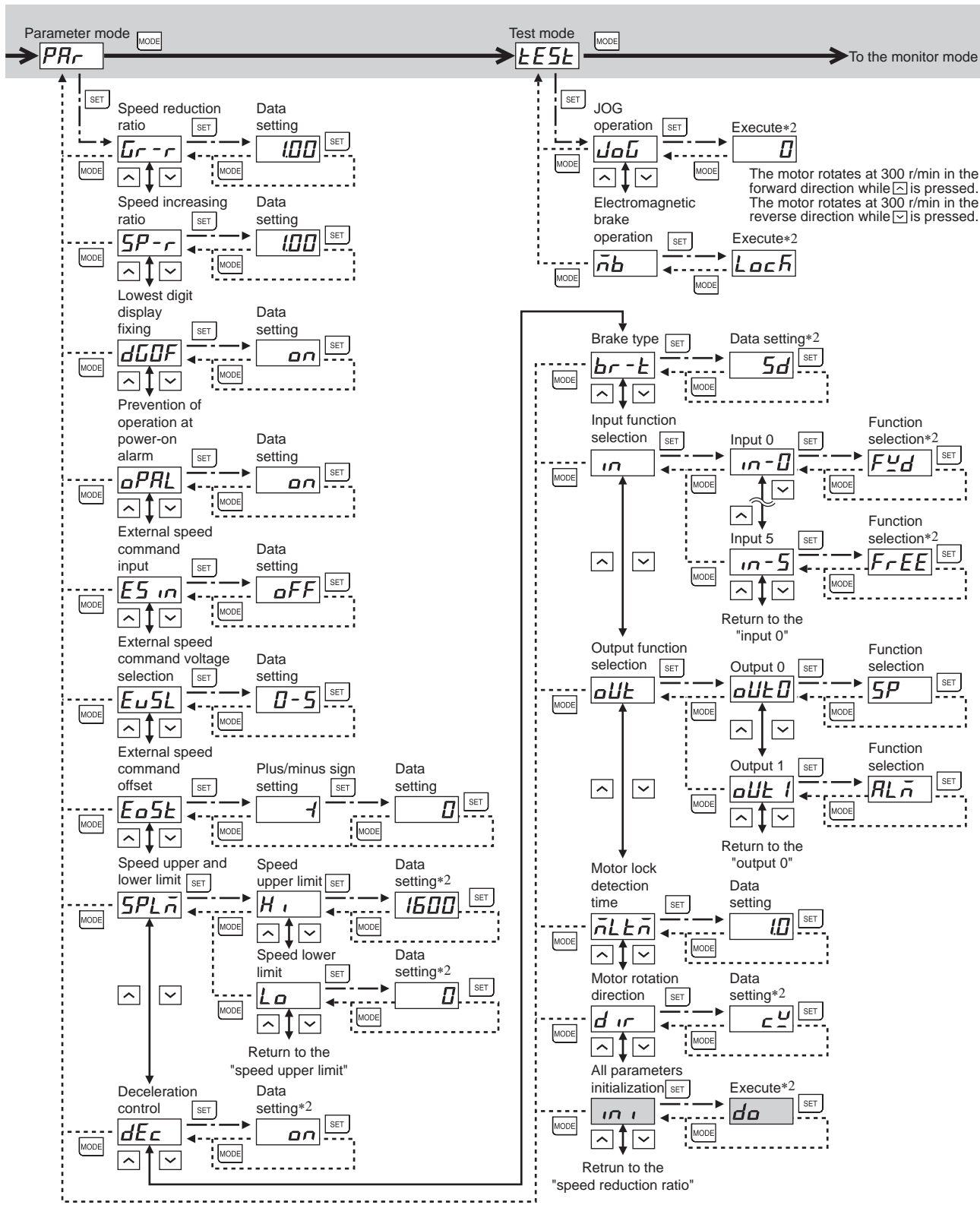

7.3 Items which can be monitored

Operation mode: Monitor mode

Item	Display	Description
Rotation speed		<ul style="list-style-type: none"> The motor rotation speed is displayed. When the "speed reduction ratio" parameter is set, the rotation speed of the gear output shaft or the conveyor transfer speed is displayed. When the "speed increasing ratio" parameter is set, the rotation speed being increased by the external mechanism is displayed.
Operation data No.		The operation data number presently selected is displayed.
Alarm		<p>When an alarm generates, the corresponding alarm code is displayed. You can also check and clear alarm records in addition to resetting alarms. Refer to p.35 for alarm types, alarm codes and alarm reset.</p> <ul style="list-style-type: none"> Alarm record Alarm reset* <p>* Only available when an alarm generates.</p> <p>1 to 9: Up to the nine most recent alarm records</p>
Warning		<p>When a warning generates, the corresponding warning code is displayed. You can also check and clear warning records. Refer to p.36 for warning types and warning codes.</p> <ul style="list-style-type: none"> Warning record <p>1 to 9: Up to the nine most recent alarm records</p>
I/O monitor		<p>The ON/OFF status of each I/O signal for the speed controller can be checked. If the signal is ON, the corresponding digit is lit. If the signal is OFF, the digit is unlit. Also, the setting voltage of the external speed setter can be checked.</p> <ul style="list-style-type: none"> Input signal Output signal* <p>* The alarm output is being ON while the product operates normally.</p>

7.4 Setting the operation data

Up to 4 operation data can be set using the operation panel, and the motor can be operated by selecting the data based on a combination of ON/OFF status of the M0 and M1 inputs.

Refer to p.25 for the setting procedure and operating method.

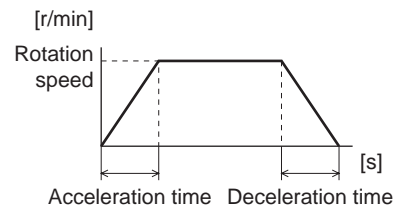

Operation mode: Data mode

Item	Display *1	Description	Setting range	Initial value
Rotation speed		Sets the rotation speed. Set as the rotation speed of the motor output shaft.	50 Hz: 0, 300 to 1400 r/min [0, 90 to 1400 r/min] *2 60 Hz: 0, 300 to 1600 r/min [0, 90 to 1600 r/min] *2	0
Acceleration time		Sets the acceleration time and deceleration time. Refer to p.21 for details.	0.2 to 15.0 s [0.0 to 15.0 s] *2	0.2 [0.0] *2
Deceleration time				
Initialization		Restores the operation data to the initial value.	-	-

*1 The digit (0 to 3), which represents the operation data number, will be displayed at the end of the string.
Operation data No.0:

*2 When the "deceleration control" parameter is set to ON.

Note Do not turn the control DC power supply while the display is blinking after executing the data setting or initialization. Doing so may damage the data.

7.5 Setting the parameters

■ Parameter list

Operation mode: Parameter mode

Item	Display	Description	Setting range	Initial value			
Speed reduction ratio	<i>G_r-r</i>	When setting the gear ratio of the gearhead, the speed being converted by the speed reduction ratio can be displayed. If the conveyor speed reduction ratio is calculated and input, the conveyor transfer speed can also be displayed.	1.00 to 9999	1.00			
Speed increasing ratio	<i>S_P-r</i>	When increasing the motor rotation speed using the external mechanism and others, the converted speed can be displayed.	1.00 to 5.00	1.00			
Lowest digit display fixing	<i>dOFF</i>	The value in the lowest digit is not stable since this product does not have enough speed stability. Therefore, the lowest digit display of the rotation speed is fixed to "0" on the display.	Fixed Not fixed	<i>on</i> <i>off</i> <i>on</i>			
Prevention of operation at power-on alarm	<i>oPRL</i>	Sets whether to enable or disable the "prevention of operation at power-on alarm." When starting or stopping the motor by ON-OFF control of the power supply, set this parameter to OFF (Disable).	ON (Enable) OFF (Disable)	<i>on</i> <i>off</i> <i>on</i>			
External speed command input	<i>ES in</i>	Selects the setting method of the rotation speed for the operation data No.0. When setting the rotation speed using an external potentiometer or external DC voltage, set the external speed command input to ON (Enable). When this parameter is set to OFF (Disable), the rotation speed can be set with the operation panel.	ON (Enable) OFF (Disable)	<i>on</i> <i>off</i> <i>off</i>			
External speed command voltage selection	<i>E_USL</i>	Selects "0 - 5 VDC" or "0 to 10 VDC" in accordance with the external DC voltage used at the time of the speed setting.	0-10 VDC 0-5 VDC	<i>0-10</i> <i>0-5</i> <i>0-5</i>			
External speed command offset	<i>E_oSt</i>	Adjusts the speed difference among motors when performing multi-motor control.	-800 to +800 r/min	0			
Speed upper and lower limit	<i>S_{PL}n</i>	Speed upper limit	<i>H_l</i>	Sets the upper limit of the rotation speed.	0, 300 [90] * to 1600 r/min * When the "deceleration control" parameter is set to OFF	1600	
		Speed lower limit	<i>L_o</i>	Sets the lower limit of the rotation speed.		0	
Deceleration control	<i>dEc</i>	Sets whether to enable or disable the deceleration control. Refer to p.33 for details.	ON (Enable) OFF (Disable)	<i>on</i> <i>off</i> <i>on</i>			
Brake type	<i>br-t</i>	Selects how the motor should stop when turning the FWD input or REV input to OFF from ON.	Deceleration stop Coasting stop	<i>S_d</i> <i>FrUn</i> <i>S_d</i>			
Input function selection	<i>in</i>	IN0	<i>in-0</i>	Input signals assigned to input terminals can be changed. Refer to p.34 for details.	FWD	<i>F_{Yd}</i>	<i>F_{Yd}</i>
		IN1	<i>in-1</i>		REV	<i>rEv</i>	<i>rEv</i>
		IN2	<i>in-2</i>		M0	<i>n0</i>	<i>n0</i>
		IN3	<i>in-3</i>		M1	<i>n1</i>	<i>n1</i>
		IN4	<i>in-4</i>		ALARM-RESET	<i>ArSt</i>	<i>ArSt</i>
		IN5	<i>in-5</i>		FREE	<i>FrEE</i>	<i>FrEE</i>
Output function selection	<i>out</i>	OUT0	<i>out0</i>	Output signals assigned to output terminals can be changed. Refer to p.34 for details.	SPEED-OUT	<i>SP</i>	<i>SP</i>
		OUT1	<i>out1</i>		ALARM-OUT	<i>ALn</i>	<i>ALn</i>
					TH-OUT	<i>tH-o</i>	<i>ALn</i>
					WNG	<i>YnG</i>	
Motor lock detection time	<i>nLtn</i>	Sets the time needed to output an alarm after detecting the lock state of the motor or the disconnection of the motor cable.	1.0 to 5.0 S	1.0			
Motor rotation direction	<i>d r</i>	Sets the motor rotation direction when inputting the FWD input.	CW CCW	<i>CU</i> <i>CCU</i> <i>CU</i>			
All parameters initialization	<i>in i</i>	Restores the value set in the parameter mode to the initial value.	-	-			

Note

- Do not turn the control DC power supply while the display is blinking after executing the data setting or initialization. Doing so may damage the data.
- When setting the speed increasing ratio to 1.00, the speed reduction ratio will be effective. When setting the speed increasing ratio to other than 1.00, the speed increasing ratio will be effective.
- If the "deceleration control" parameter is changed, the settings of the operation data and "speed upper and lower limit" parameter will be initialized.
- When performing a vertical operation, do not set a longer time in the "motor lock detection time" parameter. Doing so may cause a load to fall or damage to the product.

■ Displayed digit number when setting the speed reduction ratio or speed increasing ratio

Since the number of significant figures for the integer part is changed if the speed reduction ratio or speed increasing ratio is set, the digit number displayed on the panel will also be changed.

Setting value for the speed reduction ratio and speed increasing ratio	Display digit on the panel
1.00 to 9.99	0 to 9999
10.00 to 99.99	0.0 to 999.9
100.0 to 999.9	0.00 to 99.99
1000 or more	0.000 to 9.999

■ How to calculate the speed reduction ratio when displaying the conveyor transfer speed

To display the conveyor transfer speed, calculate the conveyor speed reduction ratio by using the formula below and set to the "speed reduction ratio" parameter.

$$\text{Conveyor speed reduction ratio} = \frac{1}{\text{Feed rate per motor revolution}} = \frac{\text{Gearhead gear ratio}}{\text{Pulley diameter [m]} \times \pi}$$

When the calculated conveyor speed reduction ratio is used, the conveyor transfer speed is converted as follows:

$$\text{Conveyor transfer speed [m/min]} = \frac{\text{Rotation speed of motor output shaft [r/min]}}{\text{Conveyor speed reduction ratio}}$$

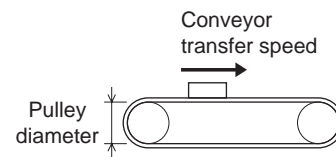

Example: The pulley diameter is 0.1 m and gear ratio of the gear head is 25

$$\text{Conveyor speed reduction ratio} = \frac{\text{Gearhead gear ratio}}{\text{Pulley diameter [m]} \times \pi} = \frac{25}{0.1 \text{ [m]} \times \pi} \approx 79.6$$

From the conversion formula, the conveyor speed reduction ratio is calculated as 79.6 in this example.

If the speed reduction ratio is 79.6 and rotation speed of the motor is 1300 r/min, the conveyor transfer speed is converted as follows:

$$\text{Conveyor transfer speed [m/min]} = \frac{1300}{79.6} \approx 16.3 \text{ Accordingly, "16.3" is shown on the display.}$$

■ Limiting the setting range of the rotation speed

The setting range of the rotation speed is set to 0 to 1600 r/min at the time of shipment. This setting range can be changed to limit.

● Speed upper limit

Set the upper limit value of the rotation speed in the "speed upper limit" of the "speed upper and lower limit" parameter. The rotation speed exceeding the "speed upper limit" cannot be set in the rotation speed of the operation data.

If the rotation speed exceeding the "speed upper limit" is already set in the operation data, the rotation speed set in the "speed upper limit" will be overwritten.

● Speed lower limit

Set the lower limit value of the rotation speed in the "speed lower limit" of the "speed upper and lower limit" parameter. The rotation speed lower than the "speed lower limit" cannot be set in the rotation speed of the operation data.

If the rotation speed lower than the "speed lower limit" is already set in the operation data, the rotation speed set in the "speed lower limit" will be overwritten.

Setting range of the rotation speed

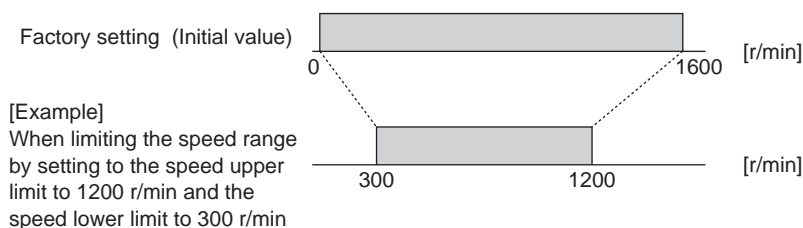

■ Stop mode selection

Any of instantaneous stop, deceleration stop, and coasting stop can be used to stop the motor.
 If both the FWD input and REV input are turned ON, the motor stops instantaneously.
 Select how the motor should stop when turning the FWD input or REV input to OFF from ON.

"Brake type" parameter	Deceleration stop <i>S_d</i> (Initial value)	Coasting stop <i>F_{rUn}</i>
Operation flow (image)	<p>When the signal is turned OFF, the deceleration control is performed and the motor will stop with the deceleration time. The electromagnetic brake will hold the shaft after the deceleration time.</p>	<p>The output power to the motor is shut off at the same time as the signal is turned OFF, and the motor will coast to a stop. The electromagnetic brake will hold the shaft after the motor stops.</p>

■ Setting the deceleration control

This is a function to adjust the speed by flowing the brake current automatically if the motor is rotated faster than the set rotation speed.

Even if a vertical operation is performed or the force is applied to the direction where the motor output shaft has been rotated by the load inertia, the motor is operated so that the set rotation speed is kept.

When a vertical operation is performed, be sure to set the "deceleration control" parameter to ON.

When a horizontal operation is performed, the setting range for the rotation speed, acceleration/deceleration time, and action for when the motor starts can be changed by setting the "deceleration control" parameter to OFF.

"Deceleration control" parameter	ON (Initial value)	OFF
Rotation speed	300 to 1400 r/min (50 Hz) 300 to 1600 r/min (60 Hz)	90 to 1400 r/min (50 Hz) 90 to 1600 r/min (60 Hz)
Setting range	0.2 to 15.0 s	0.0 to 15.0 s
Operation flow (image)	<p>* About 0.1 sec in maximum (it varies depending on the set rotation speed)</p>	

If the deceleration time is set shorter than the time of the coasting stop while the "deceleration control" parameter is set to OFF, the motor will stop by actuating the electromagnetic brake after the deceleration time.

■ Description of I/O signals which can be assigned

6 input signals and 2 output signals out of the following signals can be assigned.

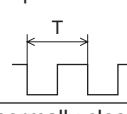
Signal	Terminal	Signal name	Description
Input	IN0 IN1 IN2 IN3 IN4 IN5	FWD	When the FWD input is turned ON, the motor output shaft rotates in the forward direction based on the set acceleration time. When the REV input is turned ON, the motor output shaft rotates in the reverse direction.
		REV	When the input is turned OFF, the motor will stop based on the set deceleration time. If both the FWD input and REV input are turned ON, the motor stops instantaneously. (The rotation direction can be changed with the parameter setting.)
		M0	These signals are used to select the operation data. The operation data which is executed can be selected from 4 operation data in a combination of these signals.
		M1	
		ALARM-RESET	This signal is used to reset the present alarm generated by which the protective function of the speed controller was activated. Be sure to remove the cause of the alarm before turning the ALARM-RESET input ON. Refer to p.36 for the resetting methods and timing chart.
		FREE	If the FREE input is turned ON, the electromagnetic brake will be released. If the FWD input or REV input is turned ON while the FREE input is being ON, the motor will not rotate. If the FREE input is turned ON while the motor is operated, the motor will coast to a stop.
		EXT-ERROR	When turning this signal OFF, an alarm generates and the motor stops. Then "AL EE" will be shown on the display (normally closed).
Output	OUT0 OUT1	SPEED-OUT	12 pulses are output with each revolution of the motor output shaft synchronously with the motor operation. The motor rotation speed can be calculated by checking the SPEED-OUT output frequency. $\text{Motor rotation speed [r/min]} = \frac{\text{SPEED-OUT output frequency [Hz]} \times 60}{12}$ $\text{SPEED-OUT output frequency} = \frac{1}{T}$ <div style="text-align: right;"> <p>SPEED-OUT output waveform</p>  </div>
		ALARM-OUT	This signal will be turned OFF when an alarm generates (normally closed).
		TH-OUT	When the built-in overheat protection device (thermal protector) of the motor is activated (OPEN), this output signal will be turned ON. If the motor temperature drops and the thermal protector is closed, this output signal will be turned OFF. (It is enabled while the AC power is input.)
		WNG	This signal is output when a warning generates. When the warning is released, it will automatically turn OFF.

7.6 Releasing operation of electromagnetic brake

The electromagnetic brake can be released using the operation panel while the motor stops. This is a function to adjust the position manually for when moving a load at motor standstill. If the FREE input is being ON, the electromagnetic brake operation using the operation panel is not possible.

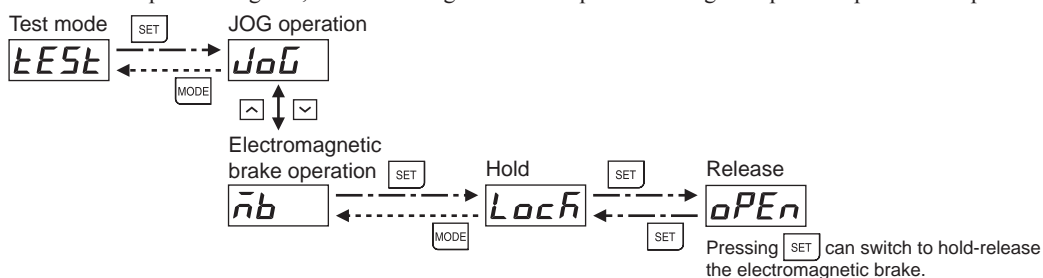

7.7 Prohibiting data editing

This is a function to prevent the set data from editing or clearing by mistake. Operation data (rotation speed etc.) and parameters cannot be changed while the edit lock function is enabled.

• Setting of the edit lock function

Press **MODE** for minimum 5 seconds on the top screen. LF

• Resetting of the edit lock function

Press **MODE** for minimum 5 seconds on the top screen. UnLF

• Display for when the edit lock function is enabled

If the setting value of the operation data or parameter is tried to change while the edit lock function is enabled, "LF" is displayed for about one second.

8 Alarm and warning

The speed controller provides alarms that are designed to protect the speed controller from overheating, poor connection, error in operation, etc. (protective functions), as well as warnings that are output before the corresponding alarms generate (warning functions).

8.1 Alarm

If the protective function is activated, the speed controller shuts off the output power to the motor, and the electromagnetic brake holds the motor shaft.

At the same time, the alarm output is turned OFF, and the ALRM LED will be lit (red) in addition that the alarm code is shown on the display.

The electromagnetic brake cannot be released while the alarm is generated.

■ Alarm list

Alarm code	Alarm type	Cause	Remedial action
<i>RL26</i>	Motor overheat	<ul style="list-style-type: none"> The motor abnormally produced heat by some reason and a built-in overheat protection device (thermal protector) of the motor was activated (OPEN). Disconnection or improper connection for the motor cable *1 	<ul style="list-style-type: none"> Reduce the load. Improve the operation condition such as the acceleration time or deceleration time. Check the motor cable or connection of connector part.
<i>RL30</i>	Motor lock	<ul style="list-style-type: none"> The motor output shaft was locked more than the time set in the "motor lock detection time" parameter. Disconnection or improper connection for the motor cable *1 	<ul style="list-style-type: none"> Reduce the load. Check the motor cable or connection of connector part.
<i>RL31</i>	Overspeed	<ul style="list-style-type: none"> The rotation speed of the motor output shaft exceeded approximately 2300 r/min. 	<ul style="list-style-type: none"> Check whether the motor is rotated by a load or external force.
<i>RL41</i>	EEPROM error *2	<ul style="list-style-type: none"> The control DC power supply was turned off while executing the data setting or initialization. The stored data was damaged. Data became no longer writable or readable. 	<ul style="list-style-type: none"> Initialize the data and parameters. If the alarm cannot be cleared even when the power has been cycled, contact your nearest Oriental Motor sales office.
<i>RL46</i>	Prevention of operation at power-on *3	The power supply was turned on while the FWD input or REV input was being ON.	If the FWD input or REV input which has been turned ON is turned OFF, the alarm will be reset.
<i>RL6E</i>	External stop *4	The EXT-ERROR input turned OFF.	Check the EXT-ERROR input.

*1 The generated alarm varies depending on the places of disconnection or improper connection.

*2 This alarm cannot be reset by the ALARM-RESET input.

*3 If the "prevention of operation at power-on" parameter is set to disable, this alarm will not generate. (Initial setting: Enable)

*4 Only when the EXT-ERROR is assigned.

• "Motor overheat" alarm

Motors with an output power of 15 W to 90 W contain an automatic return type thermal protector in the motor windings. If the motor internal temperature exceeds the specified value, the thermal protector will be activated (OPEN) and the "motor overheat" alarm will be generated. If the TH-OUT output is assigned to the output signal, the status (OPEN/CLOSE) of the built-in thermal protector can be detected. Motors with an output power of 6 W are adopted impedance protection for overheat protection so that the temperature will not rise above certain level.

• "Overspeed" alarm

This product is equipped a function to suppress the generation of the "overspeed" alarm.

If the rotation speed of the motor output shaft is exceeded approximately 2100 r/min, the brake current is automatically flowed to decelerate the motor.

■ Alarm reset

Turn the FWD input and REV input OFF, and remove the cause of the alarm before resetting the alarm by any of the following methods.

- Turn the ALARM-RESET input to ON. (The alarm will be reset at the ON edeg of the input.)
- Execute an alarm reset using the operation panel.
- Cycle the control DC power.

- Note**
- If the product does not operate properly after the control DC power supply is cycled, internal circuit damage is suspected. Contact your nearest Oriental Motor sales office.
 - Continuing the operation without removing the cause of the alarm may cause damage to equipment.
 - Do not turn off the control DC power supply for at least 1 second after an alarm is generated. Doing so may damage the data.

- **Reset using the ALARM-RESET input**

Turn both the FWD input and REV input OFF before turning the ALRM-RESET input ON. The ALARM-RESET input is disabled while the FWD input or REV input is being ON. The figure shows an example for the FWD input.

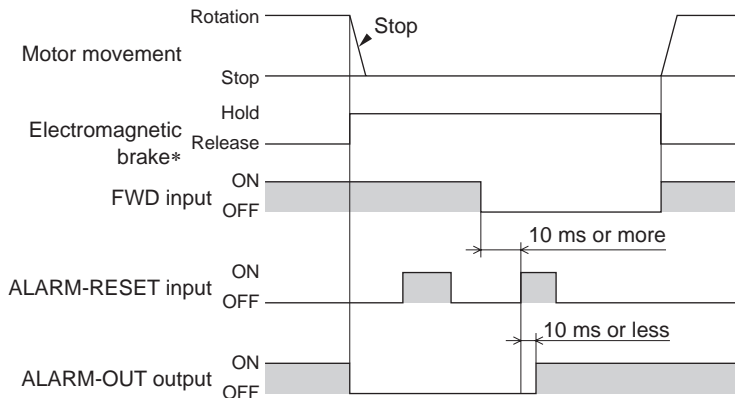

* The electromagnetic brake will hold the shaft at the moment an alarm generates.

- **Reset using the operation panel**

Execute according to the following procedures after turning both the FWD input and REV input OFF.

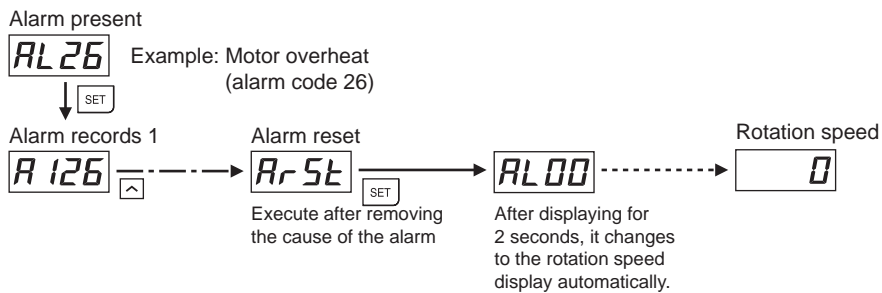

■ Alarm records

Up to 9 generated alarms are saved in the non-volatile memory in order of the latest to oldest. When clearing the alarm records, execute the alarm record clear on the monitor mode.

Note Do not turn off the control DC power supply while alarm records are being cleared (=while the display is blinking). Doing so may damage the data.

8.2 Warning

The warning types and records can be displayed on the monitor mode.

When a warning generates, the WNG output will be turned ON. The WNG output is not assigned to the output terminal at the time of shipment. Refer to "Description of I/O signals which can be assigned" on p.34.

The warning records will be cleared by turning off the control DC power supply.

■ Warning list

Warning code	Warning type	Motor movement	Generation condition	Remedial action
U _n 30	Motor lock	Continue to operate	The motor output shaft was locked for a minimum of 1 seconds.	Check the load condition.
U _n 5c	Operation error	Stop	While the input terminal was being ON, the FWD input or REV input was assigned using the "input function selection" parameter.	When assigning the FWD input or REV input, check that the input terminal to be assigned is being OFF.
			When changing to the other mode after JOG operation was executed, the FWD input or REV input was being ON.	Turn both the FWD input and REV input OFF.

9 Troubleshooting and remedial actions

During motor operation, the motor or speed controller may fail to function properly due to an improper rotation speed setting or wiring. When the motor cannot be operated correctly, refer to the contents provided in this section and take appropriate action. If the problem persists, contact your nearest Oriental Motor sales office.

Note Certain items must be checked with the power on. Perform inspections carefully not to touch the live part such as connection part of the motor and speed controller.

Possible cause	Remedial action
● The motor does not rotate.	
Both the FWD input and REV input are being OFF.	Turn either of the FWD input or REV input ON.
Both the FWD input and REV input are being ON.	
The rotation speed has not set in the operation data.	Set the operation data. The motor does not rotate if the rotation speed is not set.
Although the external speed setter is used to set the rotation speed, the setting in the "external speed command" parameter has not changed.	Set the "external speed command" parameter to "ON (Enable)."
The AC power supply, motor or capacitor has not connected correctly.	Check the connection.
The FREE input is being ON.	Turn the FREE input OFF.
● The speed cannot change. The motor does not rotate at the set speed.	
The operation data selection input has not been switched.	Check whether the M0 input and M1 input is switched correctly.
When the external speed setter is used, both the M0 and M1 inputs are not turned OFF.	Turn the M0 and M1 inputs OFF.
When the external speed setter is used, the "external speed command" parameter has not changed.	Set the "external speed command" parameter to "ON (Enable)."
The setting range of the rotation speed is limited.	Check the setting for the "speed upper limit" and "speed lower limit" parameters.
● The motor rotates in the direction opposite to the specified direction.	
The FWD input and REV input are connected wrongly or otherwise not connected correctly.	Check the connection of the FWD input and REV input.
The gearhead that rotates in the opposite direction to the motor rotation direction is used.	Reverse the FWD input and REV input operations. For details, refer to "6.5 Motor rotation direction" on p.22.
	Change the setting for the "motor rotation direction" parameter.
The setting for the "motor rotation direction" parameter is changed.	Change the setting for the "motor rotation direction" parameter.
● The setting cannot be performed using the operation panel	
The edit lock function has been enabled.	Release the edit lock function.
● Motor operation is unstable. Motor vibration is too great.	
Effect of electrical noise.	Refer to "11.2 Installing and wiring in compliance with EMC Directive" on p.40 for measures with regard to noise.
● The motor doesn't start instantaneously.	
The acceleration time is too long.	Adjust the acceleration time.
Load inertia may be excessive.	Reduce the load inertia.
A load may be excessive	Reduce the load.
● The electromagnetic brake does not hold.	
The FREE input is being ON.	Turn the FREE input OFF.
● The motor rotates even if the speed command has not input.	
The speed has been set in the "speed lower limit" parameter.	Set the value in the "speed lower limit" parameter to "0."
● The alarm code is displayed	
Refer to "8.1 Alarm" on p.35.	

10 Inspection

It is recommended that periodic inspections for the items listed below are conducted after each operation of the motor. If an abnormal condition is noted, discontinue any use and contact your nearest Oriental Motor sales office.

- Note**
- Conduct the insulation resistance measurement or dielectric strength test separately on the motor and the speed controller. Conducting the insulation resistance measurement or dielectric strength test with the motor and speed controller connected may result in damage to the product.
 - The speed controller uses semiconductor elements. So be extremely careful when handling them. Static electricity may damage the speed controller.

■ Inspection item

- Are the mounting screws of the motor/gearhead loose?
- Are there any abnormal noises in the motor bearings (ball bearings)?
- Are there any abnormal noises in the bearing (ball bearing) and gear meshing parts of the gearhead?
- Are the gearhead output shaft and load shaft out of alignment?
- Are there any scratches or signs of stress in the cable, or are there any loose connections between the motor and speed controller?
- Are the openings in the speed controller blocked?
- Are any of the speed controller connectors loose?
- Are there any unusual smells or appearances in the speed controller?

11 Standard and CE Marking

11.1 Standard and CE Marking

This product is recognized by UL under the UL and CSA standards, and it conforms to the China Compulsory Certification System (CCC System). This product is also affixed the CE Marking under the Low Voltage Directive and EMC Directive.

The name of products certified to conform with relevant standards are represented by applicable unit model motor and speed controller part numbers.

■ UL Standards, CSA Standards, CCC System

Applicable Standards

	Applicable Standards	Certification Body / Standards File No.
Motor	UL 1004-1, UL 1004-2, UL 1004-3 CSA C22.2 No.100, CSA C22.2 No.77	UL / UL File No.E64197, E64199
	GB12350	CQC
Speed controller	UL 508 CSA C22.2 No.14	UL / UL File No.E91291

■ Low Voltage Directive

- This product is designed and manufactured to be incorporated in equipment.
- This product cannot be used with cables normally used for IT equipment.
- Install the product within the enclosure in order to avoid contact with hands.
- Be sure to ground the Protective Earth Terminal of the motor.
- Isolate the motor cable, power-supply cable and other drive cables from the signal cables (CN4) by means of double insulation.

Applicable Standards

Motor: EN 60034-1, EN 60034-5, EN 60664-1

Speed controller: EN 50178

Momentary excess torque based on EN 60034-1

Motor model	Momentary excess torque
3IK15, 5IK60	120% of the rated torque
2IK6, 4IK25, 5IK40, 5IK90	130% of the rated torque

Momentary excess torque represents a maximum torque that can maintain the operation for 15 seconds without stalling or abrupt speed change even if the torque is increased gently while operating at rated voltage and rated frequency.

Installation conditions (EN Standard)

Motor	Speed controller
Overvoltage category: II Pollution degree: 2 Protection against electric shock: Class I	Overvoltage category: II Pollution degree: 2 Protection against electric shock: Class II

If the overvoltage category III and pollution degree 3 are required for the equipment, install the motor and speed controller in an enclosure whose degree of protection is equivalent to IP54 or higher, and supply a rated voltage via the insulation transformer.

The motor temperature rise tests stipulated in the UL Standards, CSA Standards, GB Standards, and EN Standards are conducted in a state in which the motor is mounted on a heat radiation plate instead of attaching a gearhead. The specification of heat radiation plates is as follows.

Motor model	Size [mm (in.)]	Thickness [mm (in.)]	Material
2IK6	115×115 (4.53×4.53)	5 (0.20)	Aluminum alloy
3IK15	125×125 (4.92×4.92)		
4IK25	135×135 (5.31×5.31)		
5IK40	165×165 (6.50×6.50)		
5IK60, 5IK90	200×200 (7.87×7.87)		

Thermal class: 130 (B)

■ EMC Directive

This product has received EMC compliance under the conditions specified in "Example of motor and driver installation and wiring" on p.41. Since the final level of conformance of the machinery equipment to the EMC Directive will vary depending on such factors as the configuration, wiring, layout and risk involved in the control-system devices and electrical parts that are used with the motor/speed controller, the customer must conduct the EMC tests on the machinery equipment to confirm compliance.

Applicable Standards

EMI	Emission Tests	EN 61000-6-4
	Harmonics Current Test	EN 61000-3-2
	Voltage Fluctuations Test	EN 61000-3-3
EMS	Immunity Tests	EN 61000-6-2

This type of PDS is not intended to be used on a low-voltage public network which supplies domestic premises; radio frequency interference is expected if used on such a network.

■ Hazardous substances

The products do not contain the substances exceeding the restriction values of RoHS Directive (2011/65/EU).

■ Republic of Korea, Radio Waves Act.



한국전파법

Seller and user shall be noticed that this equipment is suitable for electromagnetic equipments for office work (Class A) and it can be used outside home.

이 기기는 업무용(A 급) 전자파적합기기로서 판매자 또는 사용자는 이 점을 주의하시기 바라며, 가정외의 지역에서 사용하는 것을 목적으로 합니다.

11.2 Installing and wiring in compliance with EMC Directive

The EMC Directives require that your mechanical equipment in which the product is installed satisfy the applicable requirements.

The installation/wiring methods of the motor and speed controller explained here represent the basic methods that are effective in helping your mechanical equipment conform to the EMC Directive.

Since the final level of conformance of the machinery equipment to the EMC Directive will vary depending on such factors as the configuration, wiring, layout and risk involved in the control-system devices and electrical parts that are used with the motor/speed controller, the customer must conduct the EMC tests on the machinery equipment to confirm compliance.

Effective measures must be taken against the EMI that the product may give to adjacent control-system equipment, as well as the EMS of the product itself, in order to prevent a serious functional impediment in the machinery. The use of the following installation and wiring methods will enable the product to be compliant with the EMC Directive.

■ Connecting mains filter for AC power supply line

- Install a mains filter which the customer provides, in the power line in order to prevent the noise from propagating via the AC power line. For a mains filter, use the following model or equivalent product.

Manufacturer	Model
SOSHIN ELECTRIC CO., LTD	NF2010A-UP
Schaffner EMC	FN2070-10-06

- Install the mains filter as close to the speed controller as possible. Use cable clamps and other means to secure the input cables and output cables firmly to the surface of the enclosure.
Connect the ground terminal of the mains filter to the grounding point, using as thick and short a wire as possible.
- Do not place the input cable parallel with the output cable. Parallel placement will reduce mains filter effectiveness if the enclosure's internal noise is directly coupled to the AC power supply cable by means of stray capacitance.

■ Connecting motor cable

When extending the motor cable, use a supplied connection cable or an accessory connection cable (sold separately). The wiring distance can be extended to a maximum of 10.5 m (34.4 ft.).

■ Surge arrester

A surge arrester is effective for reduction of the surge voltage of the lightning surge generated between the AC power line and earth or between AC power lines. Connect the following surge arrester.

Manufacturer	Model
SOSHIN ELECTRIC CO., LTD	LT-C12G801WS

■ Wiring the control cable

Use a braided shielded cable of AWG24 (0.2 mm²) or thicker for the control cable, and keep the wiring distance as short as possible [less than 2 m (6.6 ft.).]

■ Notes about installation and wiring

- Connect the motor, speed controller and other peripheral control equipment directly to the grounding point so as to prevent a potential difference from developing between grounds.
- When relays or electromagnetic switches are used together with the system, use mains filters and CR circuits to suppress surges generated by them.
- Keep cables as short as possible without coiling and bundling extra lengths.
- Wire the power lines such as the AC power cable and motor cable away from the signal cables by providing a minimum clearance of 100 mm (3.94 in.) between them. If the power lines (AC power cable, motor cable) and signal cables have to cross, cross them at a right angle.
- Use a connection cable (supplied or accessory) when extending the wiring distance between the motor and speed controller. The EMC measures are conducted using the Oriental Motor connection cable.

■ Example of motor and driver installation and wiring

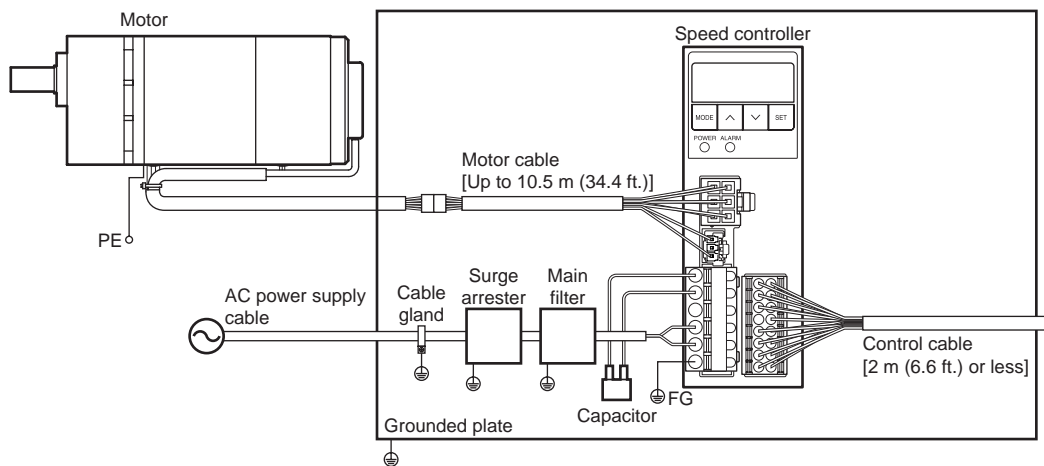

■ Precautions about static electricity

Static electricity may cause the speed controller to malfunction or suffer damaged.

Except when operating the operation panel on the speed controller, do not come near or touch the speed controller while the power is ON.

12 General specifications

Item		Motor	Speed controller
Operation environment	Ambient temperature	-10 to +40 °C [+14 to +104 °F] (non-freezing)	0 to +40 °C [+32 to +104 °F] (non-freezing)
	Ambient Humidity	85% or less (non-condensing)	
	Altitude	Up to 1000 m (3300 ft.) above sea level	
	Surrounding atmosphere	No corrosive gas, dust, water or oil. Cannot be used in radioactive materials, magnetic field, vacuum or other special environment.	
	Vibration	Not subject to continuous vibrations or excessive impact In conformance with JIS C 60068-2-6 "Sine-wave vibration test method" Frequency range: 10 to 55 Hz Pulsating amplitude: 0.15 mm (0.006 in.) Sweep direction: 3 directions (X, Y, Z) Number of sweeps: 20 times	
Storage environment	Ambient temperature	-25 to +70 °C [-13 to +158 °F] (non-freezing)	
	Ambient Humidity	85% or less (non-condensing)	
	Altitude	Up to 3000 m (10000 ft.) above sea level	
	Surrounding atmosphere	No corrosive gas, dust, water or oil. Cannot be used in radioactive materials, magnetic field, vacuum or other special environment.	
Shipping environment	Ambient temperature	-25 to +70 °C [-13 to +158 °F] (non-freezing)	
	Ambient Humidity	85% or less (non-condensing)	
	Altitude	Up to 3000 m (10000 ft.) above sea level	
	Surrounding atmosphere	No corrosive gas, dust, water or oil. Cannot be used in radioactive materials, magnetic field, vacuum or other special environment.	
Degree of protection		IP20	

13 Accessories (sold separately)

■ Connection cables

These cables are used to extend the wiring distance between the speed controller and motor. Flexible connection cables are also available.

The wiring distance can be extended to a maximum of 10.5 m (34.4 ft.).

• Connection cables

Length [m (ft.)]	Model
1 (3.3)	CC01SCM
2 (6.6)	CC02SCM
3 (9.8)	CC03SCM
5 (16.4)	CC05SCM
10 (32.8)	CC10SCM

• Flexible connection cables

Length [m (ft.)]	Model
1 (3.3)	CC01SCMR
2 (6.6)	CC02SCMR
3 (9.8)	CC03SCMR
5 (16.4)	CC05SCMR
10 (32.8)	CC10SCMR

■ General purpose cables for I/O signals

These cables are very convenient to connect I/O signals of the speed controller. Cables up to 2 m (6.6 ft.) are provided.

Length [m (ft.)]	Model	
	16 core	12 core
1 (3.3)	CC16D010B-1	CC12D010B-1
2 (6.6)	CC16D020B-1	CC12D020B-1

■ External potentiometer

This potentiometer is used to set and adjust the motor rotation speed remotely.

Model: **PAVR-20KZ**

■ Capacitor mounting bracket

This mounting bracket is used to install the capacitor to DIN rail.

Model: **PADP01C**

■ Set of a lead wire with a crimp terminal for capacitor connection

This is a lead wire with a crimp terminal which can easily connect by fitting to the capacitor terminal. 10 pieces of the lead wire of 500 mm (20 in.) are provided as a set.

Model: **LCCN0510**

- Unauthorized reproduction or copying of all or part of this manual is prohibited. If a new copy is required to replace an original manual that has been damaged or lost, please contact your nearest Oriental Motor branch or sales office.
- Oriental Motor shall not be liable whatsoever for any problems relating to industrial property rights arising from use of any information, circuit, equipment or device provided or referenced in this manual.
- Characteristics, specifications and dimensions are subject to change without notice.
- While we make every effort to offer accurate information in the manual, we welcome your input. Should you find unclear descriptions, errors or omissions, please contact the nearest office.
- **Orientalmotor** is a registered trademark or trademark of Oriental Motor Co., Ltd., in Japan and other countries. Other product names and company names mentioned in this manual may be registered trademarks or trademarks of their respective companies and are hereby acknowledged. The third-party products mentioned in this manual are recommended products, and references to their names shall not be construed as any form of performance guarantee. Oriental Motor is not liable whatsoever for the performance of these third-party products.

© Copyright ORIENTAL MOTOR CO., LTD. 2014

- Please contact your nearest Oriental Motor office for further information.

ORIENTAL MOTOR U.S.A. CORP.
 Technical Support Tel:(800)468-3982
 8:30 A.M. to 5:00 P.M., P.S.T. (M-F)
 7:30 A.M. to 5:00 P.M., C.S.T. (M-F)
www.orientalmotor.com

ORIENTAL MOTOR DO BRASIL LTDA.
 Tel:+55-11-3266-6018
www.orientalmotor.com.br

ORIENTAL MOTOR (EUROPA) GmbH
 Headquarters Düsseldorf, Germany
 Technical Support Tel:00 800/22 55 66 22
www.orientalmotor.de

ORIENTAL MOTOR (UK) LTD.
 Tel:01256-347090
www.orientalmotor.co.uk

ORIENTAL MOTOR (FRANCE) SARL
 Tel:01 47 86 97 50
www.orientalmotor.fr

ORIENTAL MOTOR ITALIA s.r.l.
 Tel:02-93906346
www.orientalmotor.it

ORIENTAL MOTOR ASIA PACIFIC PTE. LTD.
 Singapore
 Tel:1800-8420280
www.orientalmotor.com.sg

ORIENTAL MOTOR (MALAYSIA) SDN. BHD.
 Tel:1800-806161
www.orientalmotor.com.my

ORIENTAL MOTOR (THAILAND) CO., LTD.
 Tel:1800-888-881
www.orientalmotor.co.th

ORIENTAL MOTOR (INDIA) PVT. LTD.
 Tel:+91-80-41125586
www.orientalmotor.co.in

TAIWAN ORIENTAL MOTOR CO., LTD.
 Tel:0800-060708
www.orientalmotor.com.tw

SHANGHAI ORIENTAL MOTOR CO., LTD.
 Tel:400-820-6516
www.orientalmotor.com.cn

INA ORIENTAL MOTOR CO., LTD.
 Korea
 Tel:080-777-2042
www.inaom.co.kr

ORIENTAL MOTOR CO., LTD.
 Hong Kong Branch
 Tel:+852-2427-9800

ORIENTAL MOTOR CO., LTD.
 Headquarters Tokyo, Japan
 Tel:03-6744-0361
www.orientalmotor.co.jp