



OPERATING MANUAL

K II Series Induction Motor



Introduction

■ Before using the motor

Only qualified personnel should work with the product. Use the product correctly after thoroughly reading the section "Safety precautions." In addition, be sure to observe the contents described in warning, caution, and note in this manual. The product described in this manual has been designed and manufactured to be incorporated in general industrial equipment. Do not use for any other purpose. Oriental Motor Co., Ltd. is not responsible for any damage caused through failure to observe this warning.

Safety precautions

The precautions described below are intended to prevent danger or injury to the user and other personnel through safe, correct use of the product. Use the product only after carefully reading and fully understanding these instructions.

| | | |
|--|----------------|--|
| | Warning | Handling the product without observing the instructions that accompany a "Warning" symbol may result in serious injury or death. |
| | Caution | Handling the product without observing the instructions that accompany a "Caution" symbol may result in injury or property damage. |
| | Note | The items under this heading contain important handling instructions that the user should observe to ensure safe use of the product. |

Warning

- Do not use the product in explosive or corrosive environments, in the presence of flammable gases, or near combustibles. Doing so may result in fire, electric shock or injury.
- Only qualified and educated personnel should be allowed to perform installation, connection, operation and inspection/troubleshooting of the product. Handling by unqualified and uneducated personnel may result in fire, electric shock, injury or equipment damage.
- Do not transport, install the product, perform connections or inspections when the power is on. Always turn the power off before carrying out these operations. Failure to do so may result in electric shock.
- Turn off the power in the event the overheat protection device (thermal protector) is triggered. Failure to do so may result in injury or damage to equipment, since the motor will start abruptly when the overheat protection device (thermal protector) is automatically reset.
- The motor is Class I equipment. Install the motor so as to avoid contact with hands, or ground it to prevent the risk of electric shock.
- Keep the input power voltage within the specified range. Failure to do so may result in fire or electric shock.
- Securely connect the cables in accordance with the connection examples. Failure to do so may result in fire or electric shock.
- Do not forcibly bend, pull or pinch the lead wire (cable). Doing so may result in fire and electric shock.
- Insulate the connection terminals of the supplied capacitor using the supplied capacitor cap. Failure to do so may result in electric shock.
- Turn off the power in the event of a power failure. Or the motor may suddenly start when the power is restored and may cause injury or damage to equipment.
- Do not touch the connection terminal of the capacitor immediately after the power is turned off (for a period of 30 seconds). The residual voltage may cause electric shock.
- Do not disassemble or modify the motor. This may cause electric shock or injury.

Caution

- Do not use the motor beyond its specifications. Doing so may result in electric shock, injury or damage to equipment.
- Do not touch the motor during operation or immediately after stopping. The surface is hot and may cause a skin burn(s).
- Do not lift the motor by holding the motor output shaft or motor lead wire (cable). Doing so may result in injury.
- Keep the area around the motor free of combustible materials. Failure to do so may result in fire or a skin burn(s).
- Do not leave anything around the motor that would obstruct ventilation. Doing so may result in damage to equipment.
- Do not touch the rotating part (output shaft) while operating the motor. Doing so may result in injury.
- When an abnormality is noted, turn off the power immediately. Failure to do so may result in fire, electrical shock or injury.
- The motor surface temperature may exceed 70 °C (158 °F) even under normal operating conditions. If the operator is allowed to approach the running motor, attach a warning label as shown in the figure in a conspicuous position. Failure to do so may result in a skin burn(s).



Warning label

Thank you for purchasing an Oriental Motor product. This Operating Manual describes product handling procedures and safety precautions.

- Please read it thoroughly to ensure safe operation.
- Always keep the manual where it is readily available.

- Dispose the product correctly in accordance with laws and regulations, or instructions of local governments.

Preparation

■ Checking the product

Verify that the items listed below are included. Report any missing or damaged items to the branch or sales office from which you purchased the product.

- Motor 1 unit
The combination type comes with the motor and its dedicated gearhead pre-assembled.
- Capacitor 1 piece
- Capacitor cap 1 piece
- Mounting screw set 1 set (only for combination type)
Hexagonal socket head screw, washer, spring washer 4 pieces each, parallel key 1 piece
- OPERATING MANUAL 1 copy (this document)

■ Checking the model name

Check the model names of the motor and the gearhead against the model name described on each nameplate. The figures show the lead wire type. A decimal gearhead is attached depending on the gear ratio.

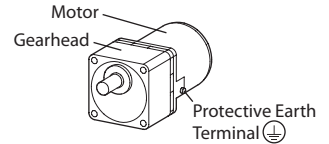

- Enter a motor classification representing the power supply voltage.
JA: Single-phase 100 V 50/60 Hz **JC:** Single-phase 200 V 50/60 Hz
UA: Single-phase 110/115 V 60 Hz **UC:** Single-phase 220/230 V 60 Hz
GC: Single-phase 220/230 V 50 Hz
- ◇ Enter a number representing the gear ratio of the combination type.
- Enter a number representing the gear ratio of the gearhead.

● Combination type

Lead wire type (Degree of protection: IP20)

| Combination type | | Motor model | Gearhead | | Decimal gearhead model |
|------------------|----------------|-------------|----------|----------------|------------------------|
| Model | Gear ratio (◇) | | Model | Gear ratio (□) | |
| 2IK6■-◇ | 2 to 360 | 2IK6GV-■ | 2GV□B | 2 to 360 | - |
| | 500 to 3600 | | | 50 to 360 | 2GV10X |
| 3IK15■-◇ | 2 to 360 | 3IK15GV-■ | 3GV□B | 2 to 360 | - |
| | 500 to 3600 | | | 50 to 360 | 3GV10X |
| 4IK25■-◇ | 2 to 360 | 4IK25GV-■ | 4GV□B | 2 to 360 | - |
| | 500 to 3600 | | | 50 to 360 | 4GV10X |
| 5IK40■-◇ | 2 to 300 | 5IK40GV-■ | 5GV□B | 2 to 300 | - |
| | 360 to 3000 | | | 36 to 300 | 5GV10X |
| 5IK60■-◇ | 2 to 300 | 5IK60GVH-■ | 5GVH□B | 2 to 300 | - |
| 5IK90■-◇ | 3 to 180 | 5IK90GVR-■ | 5GVR□B | 3 to 180 | - |

A gear ratio of the combination type attached a decimal gearhead is ten times as the gear ratio of the gearhead.

Terminal Box Type

| Combination type | | Motor model | Gearhead | | Degree of protection |
|------------------|----------------|---------------|----------|----------------|----------------------|
| Model | Gear ratio (◇) | | Model | Gear ratio (□) | |
| 4IK25■T2-◇ | 2 to 360 | 4IK25GV-■T2 | 4GV□B | 2 to 360 | IP66 |
| 5IK40■T2-◇ | 2 to 300 | 5IK40GV-■T2 | 5GV□B | 2 to 300 | |
| 5IK60■T2-◇* | 2 to 300 | 5IK60GVH-■T2* | 5GVH□B | 2 to 300 | IP54 |
| 5IK90■T2-◇ | 3 to 180 | 5IK90GVR-■T2 | 5GVR□B | 3 to 180 | |

* The degree of protection for the 5IK60GCT2-□ and 5IK60GVH-GCT2 is rated at IP66.

● Round shaft type

For the model name of the round shaft type, "A" is used instead of "GV", "GVH" or "GVR" in the "motor model name," which indicates the motor shaft type. (For the degree of protection for the round shaft type, the motor mounting surface is excluded.)

Installation

■ Location for installation

Install it in a well-ventilated location that provides easy access for inspection.

[Common conditions]

- Operating ambient temperature
Classification representing the power supply voltage
JA/JC: -10* to +50 °C (+14 to +122 °F) (non-freezing)
UA/UC/GC: -10* to +40 °C (+14 to +104 °F) (non-freezing)
 * The lowest temperature is 0 °C (+32 °F) for gearheads of the gear ratio 2 and 3.
- Operating ambient humidity 85% or less (non-condensing)

- Area that is free from an explosive atmosphere or toxic gas (such as sulfuric gas) or liquid
- Area not exposed to direct sun
- Area free of excessive amount dust, iron particles or the like
- Area free of excessive salt
- Area not subject to continuous vibration or excessive shocks
- Area free of excessive electromagnetic noise (from welders, power machinery, etc.)
- Area free of radioactive materials, magnetic fields or vacuum
- Altitude Up to 1000 m (3300 ft.) above sea level

[Degree of protection IP66 rated motor]

- Indoors
- Not exposed to oil (oil droplets) or chemicals.
The motor can be used in an environment that is splashed with water (excluding the mounting surface of the round shaft type).
Not available for use under high pressure jets of water or immersion in water.

[Degree of protection IP54/20 rated motor]

- Inside an enclosure that is installed indoors (provide vent holes)
- Area not subject to splashing water (storms, water droplets), oil (oil droplets) or other liquids

Note On rare occasions, grease may ooze out from the gearhead. If there is a concern over possible environmental damage resulting from the leakage of grease, provide an oil tray or similar oil catching mechanism in order not to cause a secondary damage. Grease leakage may lead to problems in the customer's equipment or products.

■ Installation method

Note Do not install the motor to the mounting hole diagonally or assemble the motor forcibly. Doing so may cause damage to the motor.

● Combination type

Secure the motor with mounting screw set (supplied) through the four mounting holes provided. Do not leave a gap between the motor and mounting plate.

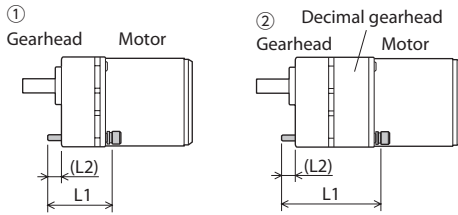
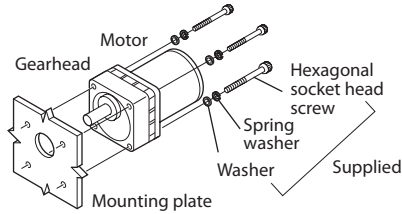

Mounting screw set (supplied)

Material: Stainless steel

| Model | Gear ratio | Hexagonal socket head screw | | Tightening torque | |
|-------|--|-----------------------------|---------------|------------------------|-------------------------|
| | | Screw size | L1 [mm (in.)] | | L2 [mm (in.)] |
| 2IK6 | ① 2, 3, 30 to 120 5 to 25 | M4 | 55 (2.17) | 8 (0.31) | 1.4 N-m (12 lb-in) |
| | | | 50 (1.97) | 7 (0.28) | |
| | ② 150 to 360 500 to 1200 1500 to 3600 | | 60 (2.36) | 8 (0.31) | |
| | | | 90 (3.54) | 14 (0.55) 9 (0.35) | |
| 3IK15 | ① 2, 3, 30 to 120 5 to 25 | M6 | 65 (2.56) | 12 (0.47) | 5.0 N-m (44 lb-in) |
| | | | 60 (2.36) | 12 (0.47) | |
| | ② 150 to 360 500 to 1200 1500 to 3600 | | 70 (2.76) | 12 (0.47) | |
| | | | 100 (3.94) | 13 (0.51) 8 (0.31) | |
| 4IK25 | ① 2, 3, 30 to 120 5 to 25 | M6 | 65 (2.56) | 9 (0.35) | 5.0 N-m (44 lb-in) |
| | | | 60 (2.36) | 9 (0.35) | |
| | ② 150 to 360 500 to 1200 1500 to 3600 | | 70 (2.76) | 9 (0.35) | |
| | | | 110 (4.33) | 15 (0.59) 10 (0.39) | |
| 5IK40 | ① 2, 3, 25 to 100 5 to 18 | M8 | 85 (3.35) | 16 (0.63) | 12.0 N-m (106 lb-in) |
| | | | 70 (2.76) | 14 (0.55) | |
| | ② 120 to 300 360 to 1000 1200 to 3000 | | 90 (3.54) | 15 (0.59) | |
| | | | 130 (5.12) | 18 (0.71) 12 (0.47) | |
| 5IK60 | ① 2, 3, 25 to 100 5 to 18 | M8 | 85 (3.35) | 16 (0.63) | 12.0 N-m (106 lb-in) |
| | | | 70 (2.76) | 14 (0.55) | |
| | | | 90 (3.54) | 15 (0.59) | |
| 5IK90 | ① 3, 18 to 36 5 to 15 | M8 | 85 (3.35) | 16 (0.63) | 12.0 N-m (106 lb-in) |
| | | | 70 (2.76) | 14 (0.55) | |
| | | | 95 (3.74) | 14 (0.55) | |

Removing and assembling the gearhead and the decimal gearhead

See the following steps to replace the gearhead or to change the outlet position of the lead wires and the position of the terminal box.

Removing the gearhead from the motor

Remove the hexagonal socket head screws (2 pieces) assembling the motor, gearhead and decimal gearhead, and detach the gearhead and decimal gearhead from the motor.

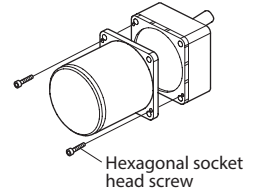

Assembling the gearhead to the motor

1. Keep the pilot sections of the motor and gearhead in parallel, and assemble the gearhead with the motor while slowly rotating it clockwise/counterclockwise. At this time, note so that the pinion of the motor output shaft does not hit the side panel or gears of the gearhead strongly.
2. Check no gaps remain between the motor and gearhead, and tighten them with hexagonal socket head screws (2 pieces). When using a decimal gearhead, install it between the motor and the gearhead.

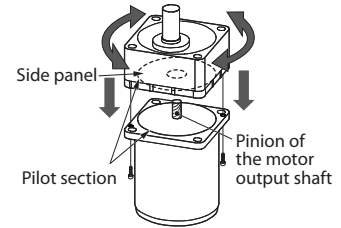

Assemble the gearhead to the motor in a condition where the motor output shaft is in an upward direction.

| Gearhead model | Screw size | Tightening torque |
|-----------------------|------------|---------------------|
| 2GV□B, 3GV□B, 4GV□B | M2.6 | 0.4 N-m (3.5 lb-in) |
| 5GV□B, 5GVH□B, 5GVR□B | M3 | 0.6 N-m (5.3 lb-in) |

- Note**
- Do not forcibly assemble the motor and gearhead. Also, prevent metal objects or foreign substances from entering in the gearhead. The pinion of the motor output shaft or gear may be damaged, resulting in noise or shorter service life.
 - O-rings are attached on the motor flange and the mounting surface of the decimal gearhead. Install the gearhead so as not to pinch the O-rings. Grease in the gearhead may leak.

● Round shaft type

Secure the motor with hexagonal socket head screws (not supplied) through the four mounting holes provided. Do not leave a gap between the motor and mounting plate.

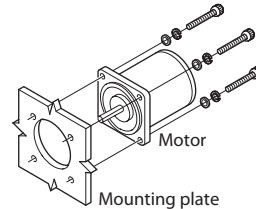

| Model | Screw size | Tightening torque |
|-------|------------|--|
| 2IK | M4 | 1.8 N-m (15 lb-in) [1.4 N-m (12 lb-in)] |
| 3IK | M5 | 3.8 N-m (33 lb-in) [3.0 N-m (26 lb-in)] |
| 4IK | | 6.4 N-m (56 lb-in) [5.0 N-m (44 lb-in)] |
| 5IK | M6 | 6.4 N-m (56 lb-in) [5.0 N-m (44 lb-in)] |

The brackets [] indicate the value for stainless steel.

● Motor with cooling fan

When installing a motor with cooling fan onto a device, leave 10 mm (0.39 in.) or more behind the fan cover or open a ventilation hole so that the cooling inlet on the back of the motor cover is not blocked.

● Mounting the capacitor

Mount the capacitor securely by using M4 screws (not provided).

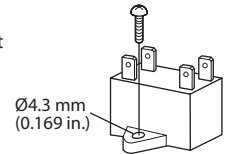

- Note**
- Do not let the screw fastening torque exceed 1 N-m (8.8 lb-in) to prevent damage to the mounting foot.
 - Mount capacitor at least 10 cm (3.94 in.) away from the motor. If it is located closer, the life of the capacitor will be shortened.

■ Installing a load

The gearhead shaft is provided with a key slot for connecting the transmission parts. When connecting the transmission parts, ensure that the shaft and parts have a clearance fit, and always fix the parallel key to the output shaft with a screw to prevent the parts from rattling or spinning.

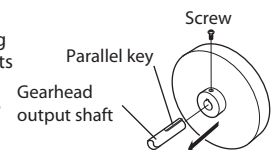

- Note**
- Do not apply excessive force onto the output shaft of the gearhead using a hammer or other tools. Doing so may cause damage to the output shaft or bearings.

● When using the output shaft end tapped hole of a gearhead

Use a tapped hole provided at the end of the output shaft as an auxiliary means for preventing the transfer mechanism from disengaging.
2GV□B, 3GV□B type have no output shaft end tapped hole.

| Gearhead model | Output shaft end tapped hole |
|---------------------------|--------------------------------------|
| 4GV□B | M5, Effective depth 10 mm (0.39 in.) |
| 5GV□B 5GVH□B 5GVR□B | M6, Effective depth 12 mm (0.47 in.) |

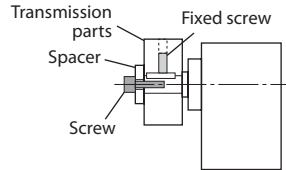

Connection

Insulate all the wire connections, such as the connection between the motor and the capacitor connection.

● Connecting Protective Earth Terminal

Be sure to ground the motor using the Protective Earth Terminal on the motor. Use a crimp terminal described below for grounding.

Applicable crimp terminal:

Insulated round crimp terminal

Terminal screw size: M4

Tightening torque: 1.0 to 1.3 N·m (8.8 to 11.5 lb-in)

Applicable minimum lead wire size:

AWG18 (0.75mm²) or thicker

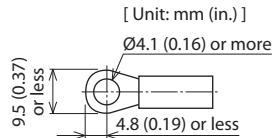

Note Be sure to use the screw for grounding attached on the product.

■ Wiring diagram

The rotation direction of the combination type varies depending on the gear ratio of the gearhead.

Check the motor model name and the gear ratio before connecting.

The connection diagram is an example of the lead wire type.

Models for the gear ratio and the round shaft type rotate as shown in the connection diagram.

Models for the gear ratio rotate in the opposite direction from the connection diagram.

| Motor model | Gear ratio | | | | | | | | | | | |
|-------------|------------|-----|-----|------|------|------|------|------|------|------|-----|-----|
| | 2 | 3 | 5 | 6 | 7.5 | 9 | 12.5 | 15 | 18 | 25 | 30 | 36 |
| 2IK6 | 2 | 3 | 5 | 6 | 7.5 | 9 | 12.5 | 15 | 18 | 25 | 30 | 36 |
| 3IK15 | 50 | 60 | 75 | 90 | 100 | 120 | 150 | 180 | 250 | 300 | 360 | 500 |
| 4IK25 | 600 | 750 | 900 | 1000 | 1200 | 1500 | 1800 | 2500 | 3000 | 3600 | - | - |
| 5IK40 | 2 | 3 | 5 | 6 | 7.5 | 9 | 12.5 | 15 | 18 | 25 | 30 | 36 |
| | 50 | 60 | 75 | 90 | 100 | 120 | 150 | 180 | 250 | 300 | 360 | 500 |
| 5IK60 | 2 | 3 | 5 | 6 | 7.5 | 9 | 12.5 | 15 | 18 | 25 | 30 | 36 |
| | 50 | 60 | 75 | 90 | 100 | 120 | 150 | 180 | 250 | 300 | - | - |
| 5IK90 | - | 3 | 5 | 6 | 7.5 | 9 | 12.5 | 15 | 18 | 25 | 30 | 36 |
| | 50 | 60 | 75 | 90 | 100 | 120 | 150 | 180 | - | - | - | - |

CW

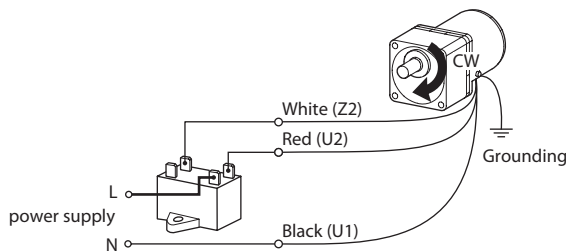

CCW

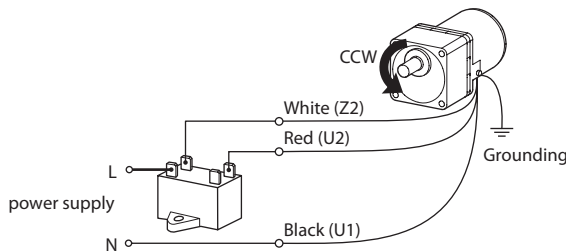

A code in the parentheses () represents a terminal code of the terminal box type.

● Contact protection

In order to protect contacts, connecting a CR circuit for surge suppression is recommended.

It is provided as an accessory (sold separately).

Model: EPCR1201-2

■ Capacitor connection

When crimp terminals are used, use the FASTON terminals 187 Series (TE Connectivity). Use the supplied capacitor cap to insulate the capacitor terminal connection.

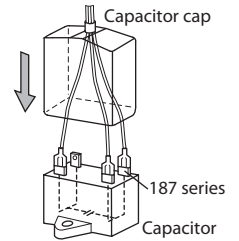

Note For lead wire connection, use one lead wire for each individual terminal.

■ Connection method to a terminal block

Remove the terminal box cover for the terminal box type, and connect a cable. Cables for connection are available as accessories (sold separately).

- If the O-ring that has set in the matching surface of the terminal box cover falls off, install it securely in the groove portion of the terminal box cover.
- After connecting the cable, securely tighten with the tightening torque in the table below.

- Note** • To make shielding function fully effective, use a cable of an appropriate diameter and observe the specified tightening torque of screws.
- Secure the cable drawn from the motor terminal box so that it does not receive stress.

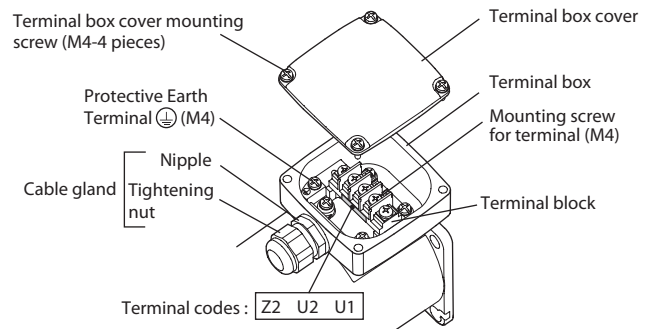

Tightening torque [Unit: N·m (lb-in)]

| | |
|-----------------------------------|--------------------------|
| Terminal box cover mounting screw | 1.0 to 1.5 (8.8 to 13.2) |
| Mounting screw for terminal | 1.0 to 1.2 (8.8 to 10.6) |
| Tightening nut | 2.0 to 2.5 (17.7 to 22) |
| Nipple | 2.0 to 2.5 (17.7 to 22) |
| Protective Earth Terminal | 1.0 to 1.5 (8.8 to 13.2) |

- When connecting the cable on the terminal block, use the following cable and crimp terminal.

Applicable crimp terminal:

Insulated round crimp terminal

Applicable cable diameter:

Ø7 to Ø13 mm (Ø0.28 to Ø0.51 in.)

Applicable lead wire:

AWG18 (0.75 mm²) or thicker

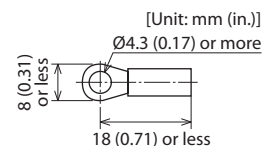

● Changing the cable outlet position

The cable outlet position can be changed to the left or right 90-degree direction, or the 180-degree direction.

When changing the direction of the cable outlet position, loosen the terminal box mounting screws, and rotate the terminal box to change the mounting direction.

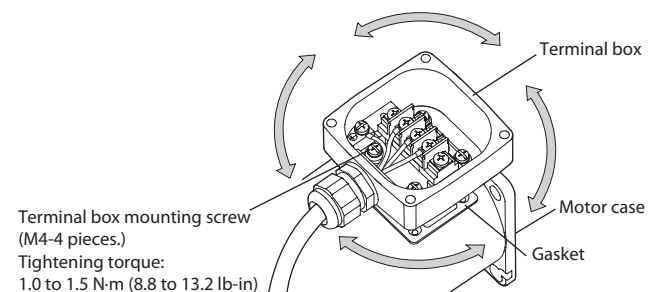

- Note** • Be sure to use the gasket which has been put in the product at the time of shipment.
- Assemble not to enter any foreign object between the terminal box and motor case.

Operation

The motor rotates when the power supply is turned on. For protection against electric shock, do not turn on the power supply until the wiring is complete.

- Note**
- Make sure that the motor case temperature does not exceed 90 °C (194 °F) when operating the motor. Operation exceeding case temperature 90 °C (194 °F) may significantly deteriorate the coils and ball bearings of the motor and shorten the motor's life span. Motor case temperature can be measured by fixing a thermometer on the motor surface. It can also be measured using thermo tape or a thermocouple.
 - To change rotation direction of the motor, wait until the motor completely stops. Otherwise its direction may not change or may take much time to change.
 - Care should be taken when using in a low-temperature environment as the transmission efficiency will drop along with the output torque.
 - Use a supplied capacitor, and always keep it connected even after the motor is started.

Time rating

Continuous operation is possible (continuous rating).

Locked rotor burnout protection

This motor is equipped with one of the two features listed below to prevent the motor from burning out as a result of abnormal heating which may be caused by misapplication.

Thermal protection

"TP" is stamped on the motor nameplate. The motor has an "auto reset" type thermal protector built into its motor coil. When the motor reaches a predetermined temperature, the internal thermal protector is activated and the motor is stopped. Always turn the power off before performing inspections.

Thermal protector activation range:

Power is turned off at 130±5 °C (266±9 °F)

Power is turned back on at 85±20 °C (185±36 °F)

Impedance protection

"ZP" is stamped on the motor nameplate. The motor has higher coil impedance. When the motor goes into locked rotor condition due to a malfunction, coil impedance rises, suppressing input power to the motor and protecting the motor coil from burnout.

Troubleshooting

When the motor cannot be operated correctly, refer to the contents provided in this section and take appropriate action. If the problem persists, contact your nearest office.

| Phenomena | Check items |
|---|--|
| Motor does not rotate. | <ul style="list-style-type: none"> • Check the power supply voltage. • Connect the power supply and the motor correctly. • Connect the supplied capacitor correctly. |
| Motor sometimes rotates and stops. | <ul style="list-style-type: none"> • If terminal blocks or crimp terminals are used, check them for poor connection. • Keep the load at or below the allowable value. |
| The motor rotates in the direction opposite to the specified direction. | <ul style="list-style-type: none"> • Connect the supplied capacitor correctly. • The connection varies depending on the gear ratio of the gearhead. • The rotation direction is as viewed from the output shaft end. Check the reference direction. |
| Motor temperature abnormally high [Motor case temperature exceeds 90 °C (194 °F)] | <ul style="list-style-type: none"> • Check the power supply voltage. • With a single-phase motor, connect the supplied capacitor correctly. • Review the ventilation condition. |
| Noisy operation | <ul style="list-style-type: none"> • Assemble the motor and gearhead correctly. • Assemble a gearhead of the same pinion type as the motor. |

Regulations and standards

UL Standards, CSA Standards, CCC System

This product is recognized by UL under the UL and CSA Standards, and also certified by CQC under the China Compulsory Certification (CCC) system. The motor model name represents the model that conforms to the standards.

Applicable standards

| Applicable standards | Certification Body / File No. |
|-----------------------------------|-------------------------------|
| UL 1004-1, UL 1004-2, UL 1004-3 | UL / |
| CSA C22.2 No.100, CSA C22.2 No.77 | UL File No.E64197, E64199 |
| GB/T 12350 | CQC |

- Thermal Class: 130 (B)

Standards for accessories

- Capacitor: UL File No.E83671 (CYWT2), VDE License No.112847 (capacitors with a rated voltage of 250 VAC), 114747 (capacitors with a rated voltage of 450 VAC)
- Capacitor cap: UL File No.E56078 (YDTU2)

CE Marking

This product is affixed the CE Marking under the Low Voltage Directive.

Low Voltage Directive

Applications standards

EN 60034-1, EN 60034-5, EN 60664-1

Momentary excess torque based on EN 60034-1

| Model | Momentary excess torque |
|-------|--------------------------|
| 2IK6 | 120% of the rated torque |
| 3IK15 | |
| 4IK25 | 130% of the rated torque |
| 5IK40 | |
| 5IK60 | |
| 5IK90 | 140% of the rated torque |

Momentary excess torque represents a maximum torque that can maintain the operation for 15 seconds without stalling or abrupt speed change even if the torque is increased gently while operating at rated voltage and rated frequency.

Installation conditions (For EN standard)

Lead wire type: Overvoltage category II, Pollution degree 2, Class I equipment
Terminal box type: Overvoltage category II, Pollution degree 3, Class I equipment
When the machinery to which the motor is mounted requires overvoltage category III specifications, install the motor in a cabinet that connect to power supply via an isolation transformer.

Motor temperature rise tests

Temperature rise tests required by the above standards are performed in a state that has been attached a heat radiation plate instead of a gearhead. The size and material for the heat radiation plates are as follows.

[Size]

2IK6: 115×115 mm (4.53×4.53 in.) 3IK15: 125×125 mm (4.92×4.92 in.)

4IK25: 135×135 mm (5.31×5.31 in.) 5IK40: 165×165 mm (6.50×6.50 in.)

5IK60, 5IK90: 200×200 mm (7.87×7.87 in.)

[Thickness] 5 mm (0.20 in.)

[Material] Aluminum alloy

RoHS Directive

The products do not contain the substances exceeding the restriction values of RoHS Directive (2011/65/EU).

- Unauthorized reproduction or copying of all or part of this manual is prohibited.
- Oriental Motor shall not be liable whatsoever for any problems relating to industrial property rights arising from use of any information, circuit, equipment or device provided or referenced in this manual.
- Characteristics, specifications and dimensions are subject to change without notice.
- While we make every effort to offer accurate information in the manual, we welcome your input. Should you find unclear descriptions, errors or omissions, please contact the nearest office.
- **Oriental motor** is a registered trademark or trademark of Oriental Motor Co., Ltd., in Japan and other countries.

© Copyright ORIENTAL MOTOR CO., LTD. 2016

Published in May 2017

- Please contact your nearest Oriental Motor office for further information.

ORIENTAL MOTOR U.S.A. CORP.
Technical Support Tel:(800)468-3982
8:30 A.M. to 5:00 P.M., P.S.T. (M-F)
7:30 A.M. to 5:00 P.M., C.S.T. (M-F)
www.orientalmotor.com

ORIENTAL MOTOR DO BRASIL LTDA.
Tel:+55-11-3266-6018
www.orientalmotor.com.br

ORIENTAL MOTOR (EUROPA) GmbH
Schiesstraße 74, 40549 Düsseldorf, Germany
Technical Support Tel:00 800/22 55 66 22
www.orientalmotor.de

ORIENTAL MOTOR (UK) LTD.
Tel:01256-347090
www.oriental-motor.co.uk

ORIENTAL MOTOR (FRANCE) SARL
Tel:01 47 86 97 50
www.orientalmotor.fr

ORIENTAL MOTOR ITALIA s.r.l.
Tel:02-93906346
www.orientalmotor.it

ORIENTAL MOTOR CO., LTD.
4-8-1 Higashiueno, Taito-ku, Tokyo 110-8536
Japan
Tel:03-6744-0361
www.orientalmotor.co.jp

ORIENTAL MOTOR ASIA PACIFIC PTE. LTD.
Singapore
Tel:1800-8420280
www.orientalmotor.com.sg

ORIENTAL MOTOR (MALAYSIA) SDN. BHD.
Tel:1800-806161
www.orientalmotor.com.my

ORIENTAL MOTOR (THAILAND) CO., LTD.
Tel:1800-888-881
www.orientalmotor.co.th

ORIENTAL MOTOR (INDIA) PVT. LTD.
Tel:+91-80-41125586
www.orientalmotor.co.in

TAIWAN ORIENTAL MOTOR CO., LTD.
Tel:0800-060708
www.orientalmotor.com.tw

SHANGHAI ORIENTAL MOTOR CO., LTD.
Tel:400-820-6516
www.orientalmotor.com.cn

INA ORIENTAL MOTOR CO., LTD.
Korea
Tel:080-777-2042
www.inaom.co.kr

ORIENTAL MOTOR CO., LTD.
Hong Kong Branch
Tel:+852-2427-9800