



AC Speed Controller

DSC Series

OPERATING MANUAL



Thank you for purchasing an Oriental Motor product.
This Operating Manual describes product handling procedures and safety precautions.

- Please read it thoroughly to ensure safe operation.
- Always keep the manual where it is readily available.



Table of contents

1	Introduction	3	7	Function.....	23
1.1	Before using the product.....	3	7.1	Functions list	23
1.2	Description of operating manual	3	7.2	Operation panel transitions.....	24
2	Safety precautions	4	7.3	Items that can be monitored	26
3	Preparation	5	7.4	Setting the operation data.....	26
3.1	Checking the product.....	5	7.5	Setting the parameters	27
3.2	How to identify the product model.....	5	■ Parameter list.....	27	
3.3	Information about nameplate	5	■ Displayed digit number when setting the speed reduction ratio or speed increasing ratio.....	28	
3.4	Products possible to combine	6	■ How to calculate the speed reduction ratio when displaying the conveyor transfer speed.....	28	
3.5	Names and functions of parts.....	7	■ Limits the setting range of the rotation speed.....	28	
4	Installation	8	■ Description of I/O signals that can be assigned	29	
4.1	Installation location	8	7.6	Prohibiting data editing.....	29
4.2	Installing the speed controller.....	8	8	Alarms.....	30
4.3	Installing the capacitor.....	10	8.1	Alarms.....	30
5	Connection	11	8.2	Warnings.....	32
5.1	Connecting the AC power supply and capacitor.....	11	9	Troubleshooting	33
5.2	Connecting the motor and speed controller	12	10	Maintenance and inspection	34
5.3	Grounding.....	12	10.1	Inspection	34
5.4	Connecting the control DC power supply and I/O signals.....	13	10.2	Warranty	34
5.5	Connection example for I/O signals and programmable controller	15	10.3	Disposal.....	34
6	Operation	16	11	Accessories (sold separately).....	35
6.1	Power ON.....	16	12	Regulations and standards	36
■ Test operation	16	12.1	UL Standards, CSA Standards.....	36	
6.2	Starting, stopping	17	12.2	EU Directives	36
6.3	Setting the rotation speed.....	17	12.3	Republic of Korea, Radio Waves Act	36
■ Setting method using the operation panel	18	12.4	RoHS Directive.....	36	
■ Remote setting method	18	12.5	Installing and wiring in compliance with EMC Directive.....	37	
6.4	Setting the acceleration time and deceleration time	19	13	Specifications.....	39
6.5	Motor rotation direction	19	13.1	Specifications.....	39
6.6	Timing chart	20	13.2	General specifications.....	39
6.7	Short time cycle operation and braking current	20			
6.8	Operating at two or more speeds (multi-speed operation).....	21			
6.9	Adjusting the rotation speed of two or more motors by a single setting device (multi-motor control)	22			

1 Introduction

1.1 Before using the product

Only qualified personnel of electrical and mechanical engineering should work with the product.

Use the product correctly after thoroughly reading the section "2 Safety precautions." In addition, be sure to observe the contents described in warning, caution, and note in this manual.

The product described in this manual has been designed and manufactured to be incorporated in general industrial equipment. Do not use for any other purpose.

Oriental Motor Co., Ltd. is not responsible for any damage caused through failure to observe this warning.

1.2 Description of operating manual

- **DSC Series OPERATING MANUAL (this document)**



This manual explains the function, installation and connection methods, troubleshooting, and others for the speed controller.

- **SCM Motor OPERATING MANUAL (Included with the motor)**

This manual explains the functions as well as the installation method and others for the motor.





2 Safety precautions



The precautions described below are intended to prevent danger or injury to the user and other personnel through safe, correct use of the product. Use the product only after carefully reading and fully understanding these instructions.

 WARNING	Handling the product without observing the instructions that accompany a "Warning" symbol may result in serious injury or death.
 CAUTION	Handling the product without observing the instructions that accompany a "Caution" symbol may result in injury or property damage.
	The items under this heading contain important handling instructions that the user should observe to ensure safe use of the product.

Explanation of graphic symbols

	Indicates "prohibited" actions that must not be performed.		Indicates "compulsory" actions that must be performed.
---	--	---	--

 WARNING	
	<ul style="list-style-type: none"> Do not use the product in explosive or corrosive environments, in the presence of flammable gases, locations subjected to splashing water, or near combustibles. Doing so may result in fire, electric shock or injury. Do not transport, install the product, perform connections or inspections when the power is on. Always turn off the power before carrying out these operations. Accidental contact may result in electric shock. The terminals on the speed controller front panel marked with   symbol indicate the presence of high voltage. Do not touch the CN1 and CN3 while the power is supplied. Doing so may result in fire or electric shock. Do not forcibly bend, pull or pinch the cable. Doing so may result in fire or electric shock. Do not touch the connector of the speed controller immediately after the power is turned off (for a period of 1 minute). Doing so may result in electric shock. Do not disassemble or modify the motor and speed controller. Doing so may result in electric shock or injury.
	<ul style="list-style-type: none"> Only qualified and educated personnel should be allowed to perform installation, connection, operation and inspection/ troubleshooting of the product. Handling by unqualified and uneducated personnel may result in fire, electric shock or injury. Install the speed controller in an enclosure. Failure to do so may result in electric shock or injury. For the AC power supply voltage of the speed controller, use the same power supply voltage as the motor specification. Failure to do so may result in fire or damage to equipment. The speed controller has no built-in fuse for overcurrent protection. Be sure to connect a device for fuse in the AC power supply line. Failure to do so may result in fire. Securely connect and ground in accordance with the section for connection. Failure to do so may result in fire or electric shock. Be sure to observe the specified cable sizes. Failure to do so may result in fire. Insulate the connection terminals of the included capacitor using the included capacitor cap. Accidental contact may result in electric shock.

 CAUTION	
	<ul style="list-style-type: none"> Do not use the motor and speed controller beyond their specifications. Doing so may result in electric shock, injury or damage to equipment. Do not carry the motor by holding the motor output shaft or motor lead wires. Doing so may cause injury. Keep the area around the motor and speed controller free of combustible materials. Failure to do so may result in fire or a skin burn(s). Do not leave anything around the motor and speed controller that would obstruct ventilation. Doing so may result in damage to equipment. Do not wire the electromagnetic contactor or power relay between the motor and speed controller. To switch the rotation direction using the electromagnetic contactor may cause damage to equipment. Do not touch the rotating part (output shaft) while operating the motor. Doing so may cause injury. Do not use the product in vertical drive (elevating application). Doing so may result in injury or damage to equipment.
	<ul style="list-style-type: none"> If an alarm of the speed controller is generated, remove the cause before resetting the alarm. Failure to do so may result in injury or damage to equipment. Securely install the motor and speed controller to the mounting plate and DIN rail respectively. Inappropriate installation may cause the motor and speed controller to drop, resulting in injury or equipment damage. Use a motor and speed controller only in the specified combination. Failure to do so may result in fire. Provide an emergency-stop device or emergency-stop circuit external to the equipment so that the entire equipment will operate safely in the event of a system failure or malfunction. Failure to do so may result in injury. Be sure to ground the motor and speed controller to prevent them from being damaged by static electricity. Failure to do so may result in damage to equipment. If abnormal conditions occurred, stop the operation immediately and turn off the speed controller power. Failure to do so may result in fire, electrical shock or injury. Conduct the insulation resistance measurement or dielectric strength test separately on the motor and speed controller. Conducting while the motor and speed controller are connected may result in damage to equipment. The motor surface temperature may exceed 70 °C (158 °F) even under normal operating conditions. If the operator is allowed to approach the motor in operation, attach a warning label in a conspicuous position as shown in the figure.



3 Preparation

This section explains the items you should check, as well as the name and function of each part.

3.1 Checking the product

Verify that the items listed below are included.

Report any missing or damaged items to the branch or sales office from which you purchased the product.

The model name purchased means the set of the speed controller and capacitor. Verify the model name shown on the package label.

Refer to "3.4 Products possible to combine" on p.6 for combinations of the motor and capacitor.

Speed controller.....1 unit

Capacitor.....1 piece

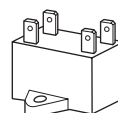
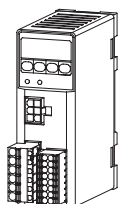

Operating manual (this document).....1 copy

Capacitor cap..... 1 piece

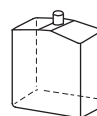

3.2 How to identify the product model

DSCD	25	JA	①	Speed controller type	DSCD: DSC Series speed controller
①	②	③	②	Output power	6: 6 W 15: 15 W 25: 25 W 40: 40 W 60: 60 W 90: 90 W
			③	Power supply voltage	JA: Single-phase 100 VAC JC: Single-phase 200 VAC UA: Single-phase 110/115 VAC EC: Single-phase 220/230 VAC

3.3 Information about nameplate

The figure shows an example.

The position describing the information may vary depending on the product.

• Speed controller

Model —

SPEED CONTROLLER
MODEL
DSC-U

INPUT 100-115V~ 50/60Hz 2.6A
200-230V~ 50/60Hz 1.3A
24V = CLASS 2 0.15A

OUTPUT 100-115V~ 50/60Hz 2.6A
(Locked Rotor Current 4.7A)
200-230V~ 50/60Hz 1.3A
(Locked Rotor Current 2.2A)

MSIP-REM-OMC-XXX SY5 123456 2017/10

ORIENTAL MOTOR CO.,LTD.
TOKYO 110-8536 JAPAN
MADE IN XXXXX

Serial number Manufacturing date

• Motor

Model —

MODEL **SCM425GV-JA**

Orientalmotor **SPEED CONTROL MOTOR**

W	V	Hz	A	μF(250V)	r/min	Amb.
25	100	50	0.49	8.0	1200	50°C
25	100	60	0.50	8.0	1450	50°C

Cont.(S1) TP Ins.Class B(S1) TE c **UL** us
IP20

产品名称: 电容运转异步电动机
过热保护: 热保护的
制造商名称: 东方马达株式会社 制造地: 日本

Manufacturing date — 2017/10

Serial number — UJX9 1234567

ORIENTAL MOTOR CO.,LTD.
TOKYO 110-8536 JAPAN MADE IN XXXXX

3.4 Products possible to combine

Be sure to match the output power and power supply voltage of the motor with those of the speed controller. Also use a capacitor in the specified combination.

The box (□) in the model name indicates the number representing the gear ratio.

In the case of the round shaft type, enter "A" instead of "GV," "GVH," or "GVR" that indicates the motor shaft type of ②.

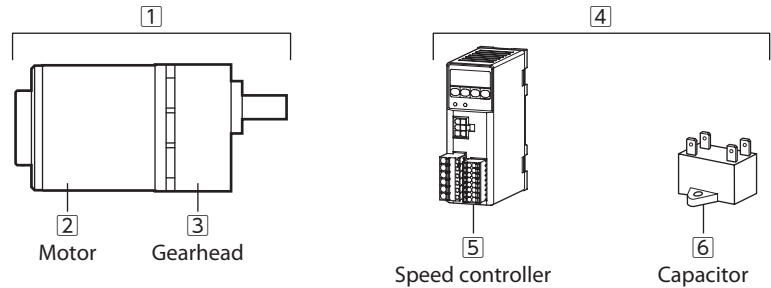

Output power	Power supply voltage	Speed control motor			Speed controller		
		Model	Component products model		Model	Component products model	
		①	②	③	④	⑤	⑥
6 W	Single-phase 100 VAC	SCM26JA-□	SCM26GV-JA		2GV□B	DSCD6JA	CH35FAUL2
	Single-phase 200 VAC	SCM26JC-□	SCM26GV-JC			DSCD6JC	CH08BFAUL
	Single-phase 110/115 VAC	SCM26UA-□	SCM26GV-UA			DSCD6UA	CH25FAUL2
	Single-phase 220/230 VAC	SCM26EC-□	SCM26GV-EC			DSCD6EC	CH06BFAUL
15 W	Single-phase 100 VAC	SCM315JA-□	SCM315GV-JA		3GV□B	DSCD15JA	CH55FAUL2
	Single-phase 200 VAC	SCM315JC-□	SCM315GV-JC			DSCD15JC	CH15BFAUL
	Single-phase 110/115 VAC	SCM315UA-□	SCM315GV-UA			DSCD15UA	CH45FAUL2
	Single-phase 220/230 VAC	SCM315EC-□	SCM315GV-EC			DSCD15EC	CH10BFAUL
25 W	Single-phase 100 VAC	SCM425JA-□	SCM425GV-JA		4GV□B	DSCD25JA	CH80CFAUL2
	Single-phase 200 VAC	SCM425JC-□	SCM425GV-JC			DSCD25JC	CH20BFAUL
	Single-phase 110/115 VAC	SCM425UA-□	SCM425GV-UA			DSCD25UA	CH65CFAUL2
	Single-phase 220/230 VAC	SCM425EC-□	SCM425GV-EC			DSCD25EC	CH15BFAUL
40 W	Single-phase 100 VAC	SCM540JA-□	SCM540GV-JA		5GV□B	DSCD40JA	CH110CFAUL2
	Single-phase 200 VAC	SCM540JC-□	SCM540GV-JC			DSCD40JC	CH30BFAUL
	Single-phase 110/115 VAC	SCM540UA-□	SCM540GV-UA			DSCD40UA	CH90CFAUL2
	Single-phase 220/230 VAC	SCM540EC-□	SCM540GV-EC			DSCD40EC	CH23BFAUL
60 W	Single-phase 100 VAC	SCM560JA-□	SCM560GVH-JA		5GVH□B	DSCD60JA	CH180CFAUL2
	Single-phase 200 VAC	SCM560JC-□	SCM560GVH-JC			DSCD60JC	CH40BFAUL
	Single-phase 110/115 VAC	SCM560UA-□	SCM560GVH-UA			DSCD60UA	CH120CFAUL2
	Single-phase 220/230 VAC	SCM560EC-□	SCM560GVH-EC			DSCD60EC	CH30BFAUL
90 W	Single-phase 100 VAC	SCM590JA-□	SCM590GVR-JA		5GVR□B	DSCD90JA	CH280CFAUL2
	Single-phase 200 VAC	SCM590JC-□	SCM590GVR-JC			DSCD90JC	CH70BFAUL
	Single-phase 110/115 VAC	SCM590UA-□	SCM590GVR-UA			DSCD90UA	CH200CFAUL2
	Single-phase 220/230 VAC	SCM590EC-□	SCM590GVR-EC			DSCD90EC	CH60BFAUL

Reference

• Combination type-parallel shaft gearhead

SCM 4 25 JA - 15

① ② ③ ④ ⑤

• Round shaft type

SCM 4 25 A - JA

① ② ③ ⑤ ④

①	Motor type	SCM: Speed control motor
②	Frame size	2: 60 mm (2.36 in.) 3: 70 mm (2.76 in.) 4: 80 mm (3.15 in.) 5: 90 mm (3.54 in.)
③	Output power	6: 6 W 15: 15 W 25: 25 W 40: 40 W 60: 60 W 90: 90 W
④	Power supply voltage	JA: Single-phase 100 VAC JC: Single-phase 200 VAC UA: Single-phase 110/115 VAC EC: Single-phase 220/230 VAC
⑤	Gear ratio · Motor shaft type	Number: Combination type gear ratio A: Round shaft type

3.5 Names and functions of parts

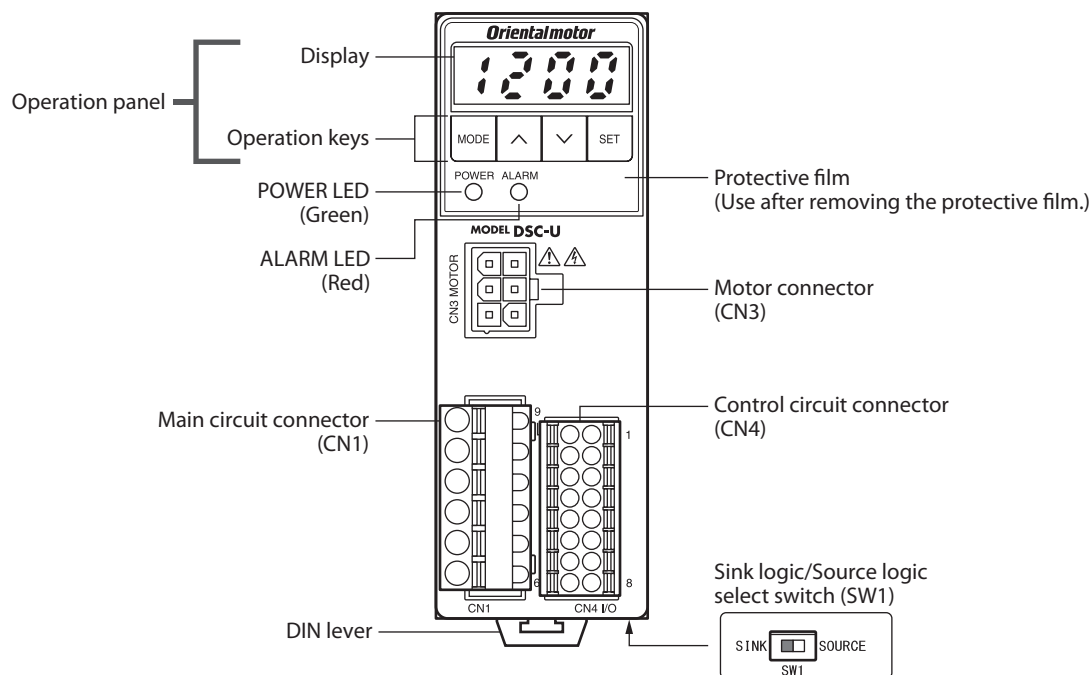

Item	Display	Overview	Reference page
Operation panel	Display	The rotation speed, parameter, alarm and others are shown on the display.	P.24
	Operation keys	MODE ^ v SET These keys are used to switch the operation mode, set the operation data or change the parameter.	
POWER LED (Green)	POWER	This LED is lit while the AC power is supplied to the speed controller.	P.16
ALARM LED (Red)	ALARM	This LED blinks while an alarm generates.	P.30
Motor connector (CN3)	CN3 MOTOR	Connects the motor connector.	P.11
Main circuit connector (CN1)	CN1	Connects the AC power supply, capacitor and FG.	
Control circuit connector (CN4)	CN4 I/O	Connects the control DC power supply and I/O signals.	P.15
Sink logic/Source logic select switch (SW1)	SW1	This switch is used for switching the input signal between sink logic and source logic modes.	
DIN lever		This is used to mount the speed controller to a DIN rail. The speed controller can also be mounted using screws.	P.9

4 Installation

This chapter explains the installation location and installation methods.

4.1 Installation location

The speed controller described in this manual has been designed and manufactured to be incorporated in general industrial equipment.

Install it in a well-ventilated location that provides easy access for inspection.

The location must also satisfy the following conditions:

- Indoors
- Operating ambient temperature: 0 to +50 °C [+32 to 122 °F] (non-freezing)
- Operating ambient humidity 85% or less (non-condensing)
- Area that is free of explosive atmosphere or toxic gas (such as sulfuric gas) or liquid
- Area not stored combustible materials
- Area not exposed to direct sun
- Area free of excessive amount of dust, iron particles or the like
- Area not subject to splashing water (rain, water droplets), oil (oil droplets) or other liquids
- Area free of excessive salt
- Area not subject to continuous vibration or excessive shocks
- Area free of excessive electromagnetic noise (from welders, power machinery, etc.)
- Area free of radioactive materials, magnetic fields or vacuum
- Altitude Up to 1000 m (3300 ft.) above sea level

4.2 Installing the speed controller

The speed controller is designed so that heat is dissipated via air convection.

Provide spaces so that the speed controller can be ventilated well through its top and bottom vent holes.

■ Installation direction

When installing the speed controller, provide a clearance of at least 25 mm (0.98 in.) in the vertical direction between the speed controller and enclosure or other equipment within the enclosure.

When installing two or more speed controllers in parallel, it is possible to install them closely in the horizontal direction.

- Vertical direction

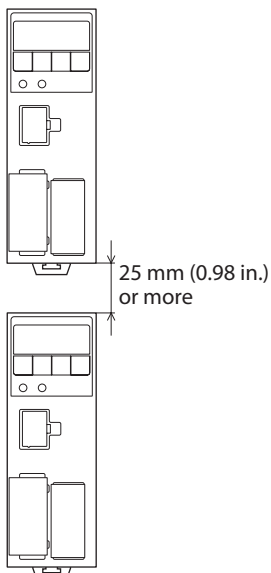

- Horizontal direction

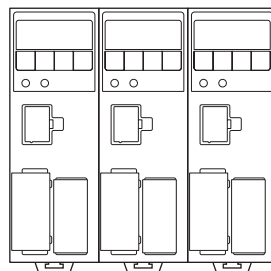

■ Installation method

● Mounting to DIN rail

Use a DIN rail 35 mm (1.38 in.) wide to mount the speed controller.

Pull down the DIN lever of the speed controller until it locks, and push the hook at the rear to the DIN rail, and then lift the DIN lever. After installation, secure the both sides of the speed controller with the end plate that the customer provides.

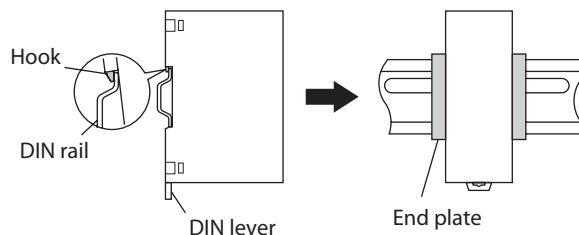

Removing from DIN rail

Pull the DIN lever down until it locks using a flat tip screwdriver, and lift the bottom of the speed controller to remove it from the rail.

Use force of about 10 to 20 N (2.2 to 4.5 lb.) to pull the DIN lever down.

Excessive force may damage the DIN lever.

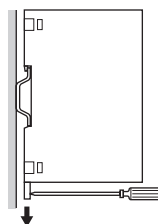

● Installing with screws

Install the speed controller through the mounting holes using two screws (M4: not included).

Tightening torque: 0.7 N·m (6.1 lb-in)

Use screws and washers, which sizes are Ø10 mm (0.39 in.) or less, to secure the speed controller.

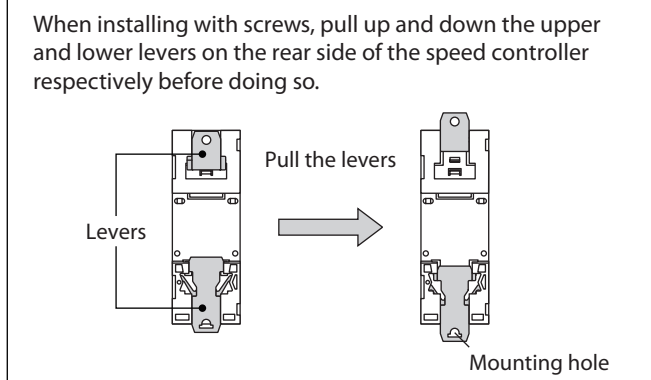
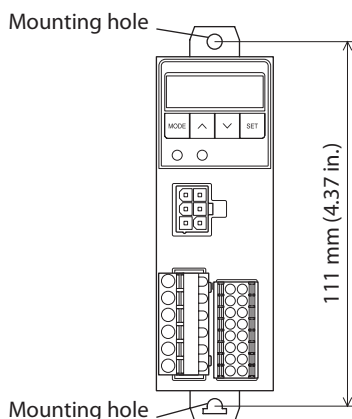

■ Dimension [Unit: mm (in.)]

Mass: 0.2 kg (0.44 lb.)

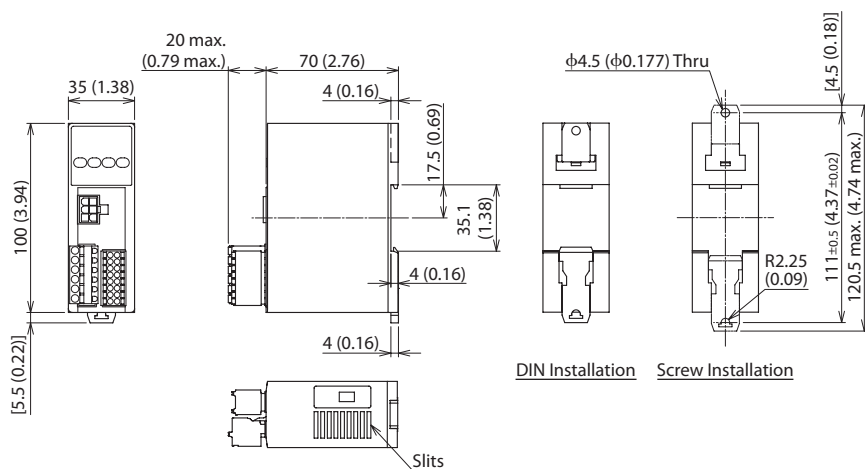

4.3 Installing the capacitor

Before mounting the provided capacitor, check that the capacitor's capacitance matches that stated on the motor's name plate. Install the capacitor securely using M4 screw (not included).

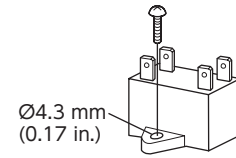

Note

- Do not let the screw tightening torque exceed 1 N·m (8.8 lb-in) to prevent damage to the mounting foot.
- Install the capacitor apart from the motor. If it is located closer, the capacitor life may be shortened due to the heat of the motor.

5 Connection

This chapter explains how to connect the speed controller, power supply, motor and others.

When operating a motor, be sure to connect the control DC power supply in addition to the AC power supply.

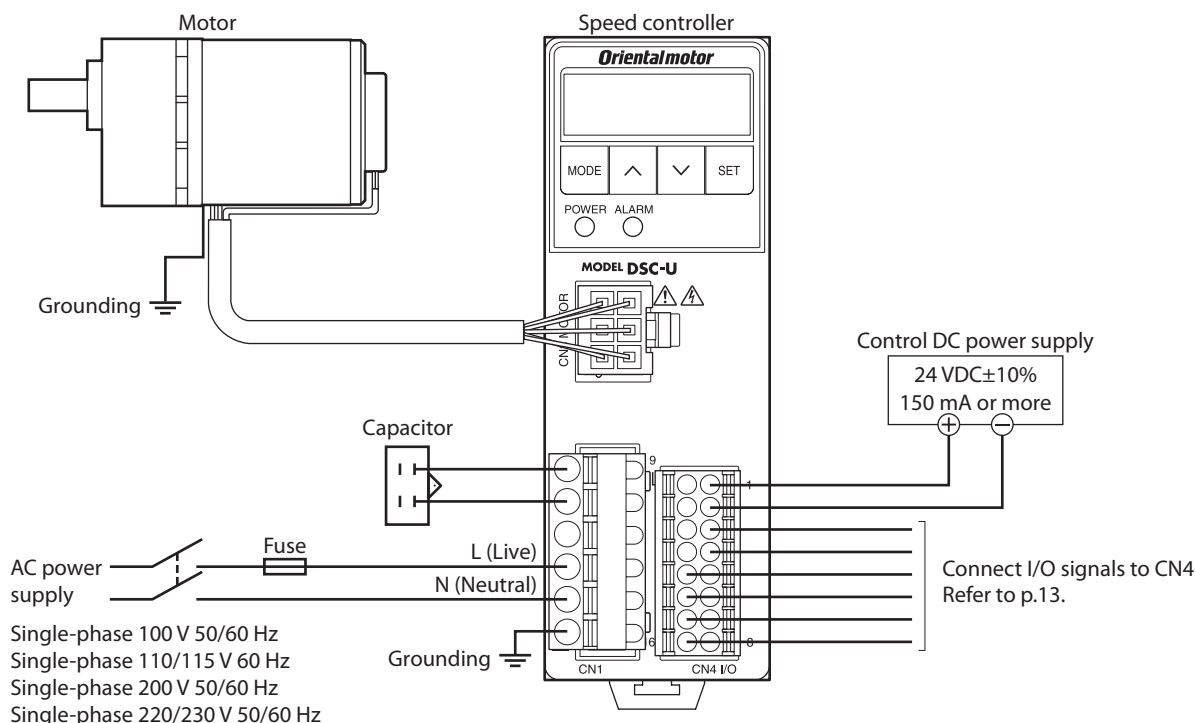

- Note**
- For the AC power supply voltage of the speed controller, be sure to use the same power supply voltage as the motor specification.
 - Firmly insert the connector in position. Insecure connection may cause malfunction or damage to the motor or speed controller.

5.1 Connecting the AC power supply and capacitor

Connect the AC power supply and capacitor to the CN1 on the speed controller.

- Applicable lead wire: AWG18 to 14 (0.75 to 2.0 mm²) *
* AWG20 to 14 (0.5 to 2.0 mm²) for capacitor connection
- Lead wire strip length: 10 mm (0.39 in.)

If crimp terminals are used, select the following terminals.

Manufacturer: PHOENIX CONTACT GmbH & Co. KG

Model: AI 0,5-10 [Conductor cross-sectional area: 0.40 - 0.65 mm² (AWG20)] *

AI 0,75-10 [Conductor cross-sectional area: 0.65 - 0.82 mm² (AWG18)]

AI 1-10 [Conductor cross-sectional area: 0.82 - 1.2 mm² (AWG18)]

AI 1,5-10 [Conductor cross-sectional area: 1.25 - 1.8 mm² (AWG16)]

AI 2,5-10 [Conductor cross-sectional area: 2.0 - 3.0 mm² (AWG14)]

* For capacitor connection

Insert the lead wire while pushing the button of the orange color with a screwdriver.

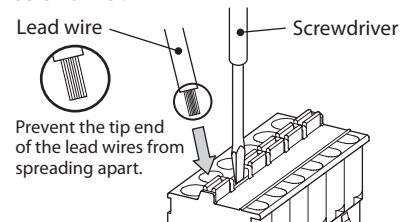

Connector model:
FKCT2,5/6-ST-5,08
(PHOENIX CONTACT GmbH & Co. KG)

- Note**
- When inserting the lead wires into the connector, prevent the tip of the lead wires from spreading apart.
Short-circuiting the lead wires may cause damage to the product.

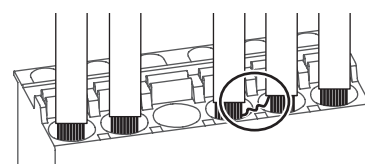

■ CN1 pin assignment

Pin No.	Description	Description
1	Capacitor	Connect the capacitor.
2		
3	N.C.	Not connected.
4	AC power supply	Connect a live wire.
5		Connect a neutral wire.
6	FG	Connect a grounding wire.

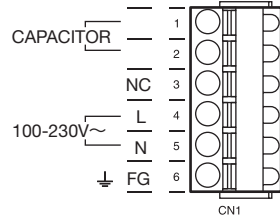

■ Connecting the capacitor

Connect the included capacitor to the speed controller.
 If crimp terminals are used, select the FASTON Terminals 187 Series (TE Connectivity).
 Use the included capacitor cap to insulate the capacitor terminal connection.

Note Be sure to use a capacitor in the specified combination.
 Unspecified combination may result in unusual temperature rise or damage to the product.
 Check capacitors possible to combine on p.6.

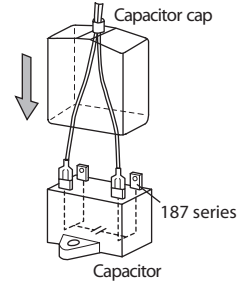

■ Connecting the earth leakage breaker

Install an earth leakage breaker to the AC power line to protect the primary circuit.
 Recommended device: Mitsubishi Electric Corporation NV series

■ Connecting the fuse

Be sure to connect a fuse in the AC power line to protect against overcurrent.

Fuse rating	Single-phase 100/110/115 VAC	216 Series (Littelfuse,Inc.) 10 A or equivalent
	Single-phase 200/220/230 VAC	216 Series (Littelfuse,Inc.) 6.3 A or equivalent

5.2 Connecting the motor and speed controller

Connect the motor cable connector to the CN3 on the speed controller.
 Use an accessory connection cable (sold separately) when extending the wiring distance between the motor and speed controller.
 The connection cable can be connected up to 3 pieces. The wiring distance between the motor and speed controller can be extended to a maximum of 10.5 m (34.4 ft.).
 A flexible connection cable is also available as an accessory.

Note Firmly insert the connector in position. Insecure connection may cause malfunction or damage to the motor or speed controller.

5.3 Grounding

Ground a motor using the Protective Earth Terminal \oplus and the speed controller using the FG terminal.

Note Be sure to ground the motor and speed controller to prevent them from being damaged by static electricity. Static electricity may cause damage to the products if they are not grounded.

■ Motor

Ground close to the motor at a shortest distance using the Protective Earth Terminal \oplus of the motor.

Applicable crimp terminal: Round crimp terminal with insulation cover
 Terminal screw size: M4
 Tightening torque: 1.0 to 1.3 N·m (8.8 to 11.5 lb-in)
 Applicable lead wire: AWG18 (0.75 mm²) or thicker

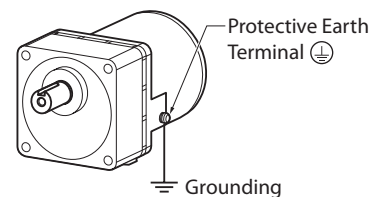
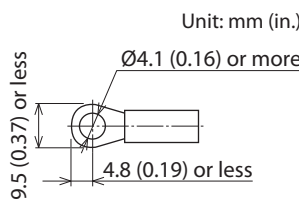

Note Do not use screws other than the Protective Earth Terminal screw attached on the product.

■ Speed controller

Ground the speed controller using the FG terminal of the CN1 (main circuit connector).

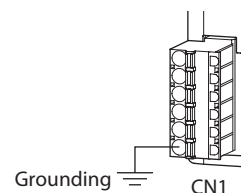

5.4 Connecting the control DC power supply and I/O signals

Connect the control DC power supply and I/O signals to the CN4.

For the control DC power supply, use a power supply with reinforced insulation on its primary and secondary sides.

- Applicable lead wire: AWG24 to 18 (0.2 to 0.75 mm²)
- Lead wire strip length: 10 mm (0.39 in.)

If crimp terminals are used, select the following terminals.

Manufacturer: PHOENIX CONTACT GmbH & Co. KG

Model: AI 0,25-10 [Conductor cross-sectional area: 0.14 - 0.34 mm² (AWG24)]

AI 0,34-10 [Conductor cross-sectional area: 0.14 - 0.34 mm² (AWG22)]

AI 0,5-10 [Conductor cross-sectional area: 0.40 - 0.65 mm² (AWG20)]

AI 0,75-10 [Conductor cross-sectional area: 0.65 - 0.82 mm² (AWG18)]

Insert the lead wire while pushing the button of the orange color with a screwdriver.

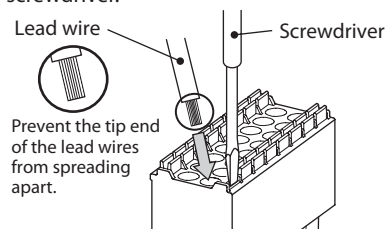

Connector model:
DFMC1,5/8-ST-3,5
(PHOENIX CONTACT GmbH & Co. KG)

■ CN4 pin assignments

Pin No.	Signal name	Function *1	Description
1	+24 V	Control DC power supply	Connect the 24 VDC power supply for control circuit.
2	0 V (GND)		
3	IN0	[FWD]	The motor rotates in the forward direction while this signal is being "ON." *2
4	IN1	[REV]	The motor rotates in the reverse direction while this signal is being "ON." *2
5	IN2	[M0]	These signals are used to select the operation data.
6	IN3	[M1]	
7	IN4	[ALARM-RESET]	This signal is used to reset the alarm.
8	IN5	[FREE]	If the FREE input is turned "ON" while the motor is operated, the motor will coast to a stop. While the FREE input is being "ON," the motor will not rotate even if the FWD input or REV input is turned "ON."
9	VH	External speed setting input	Connects when the rotation speed is set externally using the external potentiometer or external DC voltage. (Refer to p.18.)
10	VM		
11	VL		
12	N.C.	–	Not connected.
13	OUT0+	[SPEED-OUT]	12 pulses are output with each revolution of the motor output shaft.
14	OUT0–		
15	OUT1+	[ALARM-OUT]	This signal will be output when an alarm generates. (Normally closed)
16	OUT1–		

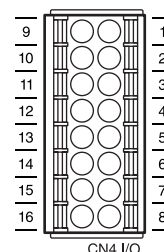

*1 The signal in brackets [] is a function that is assigned at the time of shipment. Refer to p.29 for the signals that can be assigned.

*2 The rotation direction varies depending on the setting of the parameter. Refer to p.27 for details. Also, the rotation direction of the gearhead output shaft varies depending on the gear ratio of the gearhead. Check the operating manual included with the motor.

● **Connection example for I/O signals**

The figure shows a connection example when the product is operated with the sink logic setting using relays, switches and other contact switches.

When operating and stopping the product using a programmable controller, or when using source logic, refer to p.15.

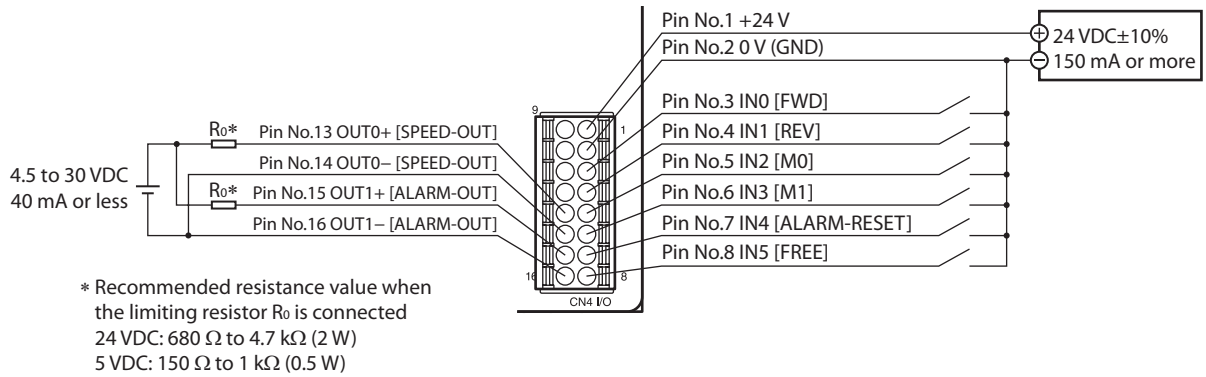

Be sure to use the current of the OUT0 and OUT1 at 40 mA or less. If the current exceeds this value, connect the current limiting resistor R_0 .

■ **Internal circuit configuration of signal input part**

All input signals of the speed controller are photocoupler inputs.

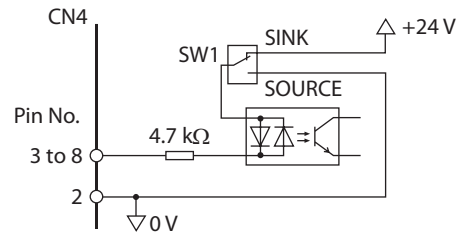

■ **Internal circuit configuration of signal output part**

All output signals of the speed controller are photocoupler/open-collector output.

The ON voltage of the output circuit is 1.6VDC maximum. When driving each element using the output signal circuit, give consideration to this ON voltage.

External power supply: 4.5 to 30 VDC, 40 mA or less

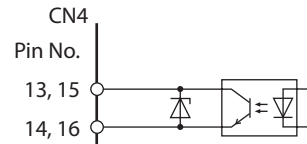

- Note**
- Always connect a current-limiting resistor. If the external power supply is connected to the output circuit directly without connecting a current-limiting resistor, the speed controller will be damaged.
 - When connecting a relay (inductive load), etc., to detect alarm outputs, provide a fly-back voltage control measure based on diode, etc., for the inductive load. Or use a relay with built-in flywheel diode.

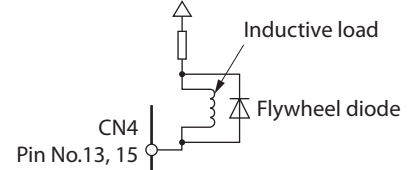

■ **Using external control equipment with a built-in clamp diode**

If external control equipment with a built-in clamp diode is used, a leakage path may form and cause the motor to operate even when the external control equipment power is off, as long as the speed controller power is on.

In addition, depending on external control equipment used together with the speed controller, the motor may rotate even when the power supplies of the external control equipment and speed controller are turned on or off simultaneously.

When powering down, turn off the speed controller power first, followed by the external control equipment power.

When powering up, turn on the external control equipment power first, followed by the speed controller power.

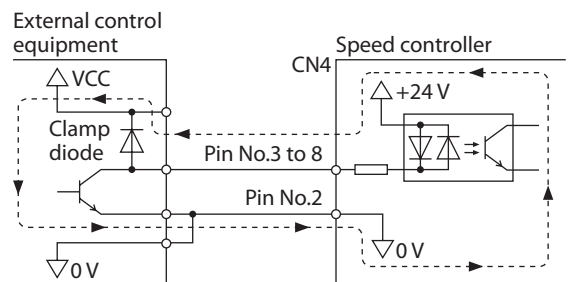

5.5 Connection example for I/O signals and programmable controller

Set the input logic to the sink logic side or source logic side in accordance with the programmable controller used with the speed controller. It is set using the SW1 as shown in the figure. Sink logic (SINK) is set at the time of shipment.

When using source logic, switch to the SOURCE side.

Figure viewed from the lower face of the speed controller

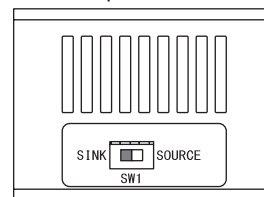

■ Sink logic (SINK)

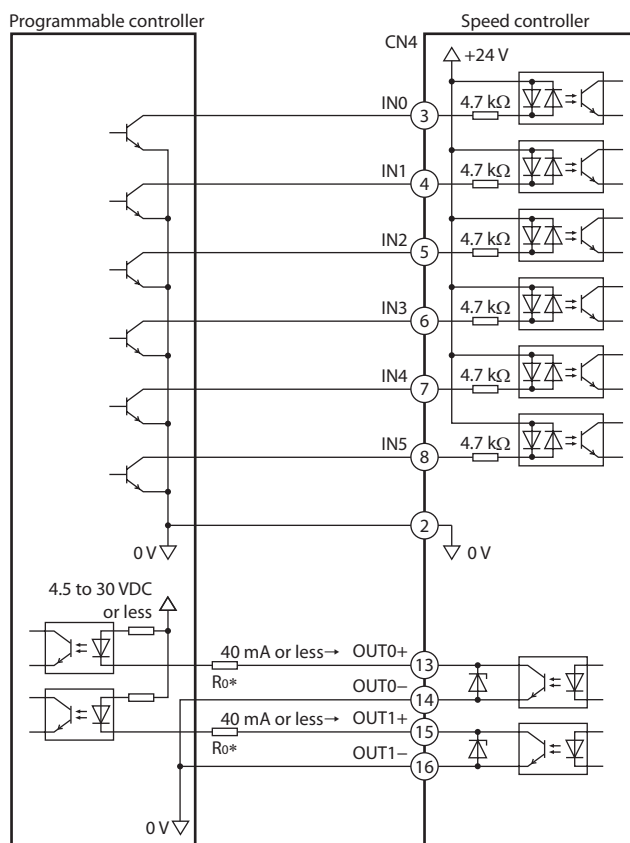

■ Source logic (SOURCE)

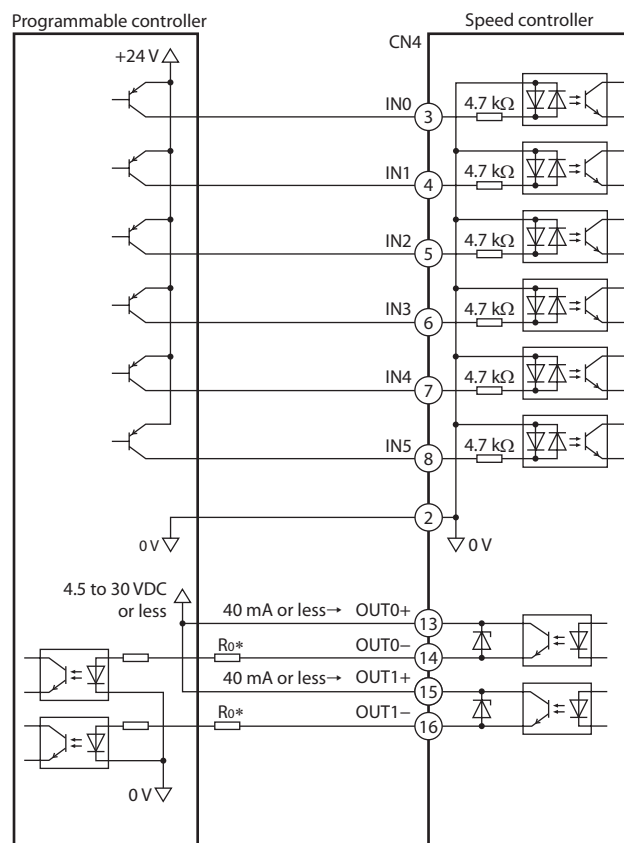

* Recommended resistance value when the limiting resistor R_0 is connected
 For 24 VDC: 680 Ω to 4.7 k Ω (2W) For 5 VDC: 150 Ω to 1 k Ω (0.5 W)



- For the voltage connecting to output signals, use between 4.5 and 30 VDC.
- Be sure to use the current of the OUT0 and OUT1 at 40 mA or less. If the current exceeds this value, connect the current limiting resistor R_0 .

6 Operation

This chapter explains how to operate the motor and speed controller.

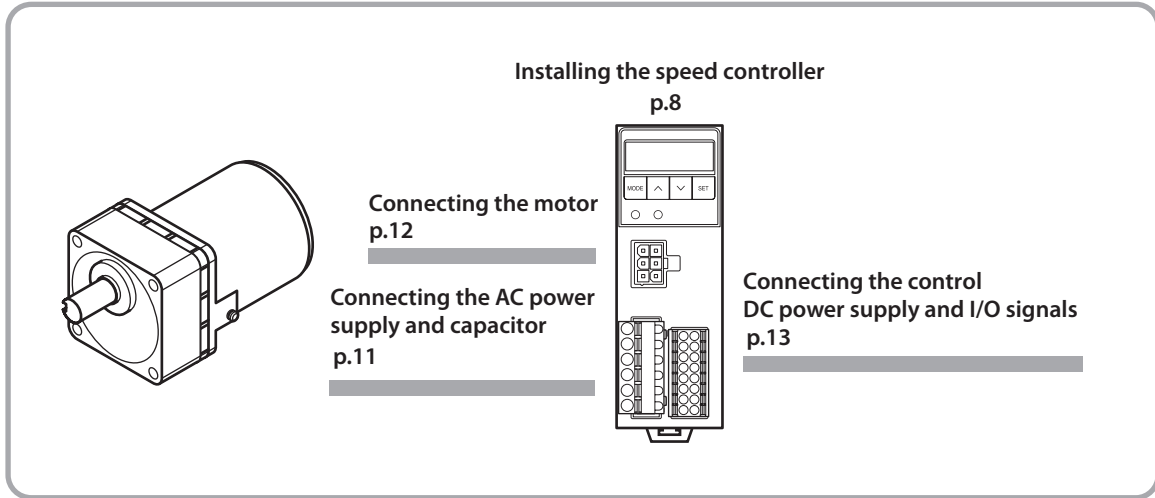

6.1 Power ON

Turn on the power after completing the connection.
 When the AC power supply is turned on, the POWER LED (green) is lit.
 When the DC power supply is turned on, is displayed.

Note If the FWD input or REV input is being ON when the power is turned on, the alarm code "AL 46" (prevention of operation at power-on alarm) is displayed, and the operation cannot be executed.
 Before supplying the power, turn both the FWD and REV inputs OFF.

Refer to p.30 for "prevention of operation at power-on alarm."

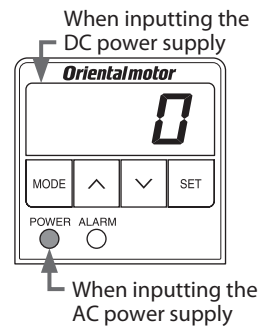

■ Test operation

The connection between the motor and speed controller can be checked.
 When performing test operation, do not install a load to the motor.
 The rotation speed in test operation is 300 r/min.

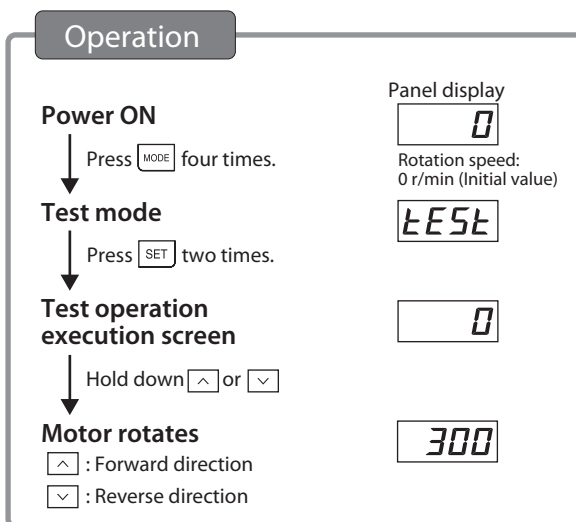

Before moving to the execution screen, if the FWD input or REV input is being ON, "Err" will be displayed.

The rotation direction of the gearhead output shaft varies depending on the gear ratio of the gearhead. Check the operating manual included with the motor.
 Refer to p.24 for the operation transitions.

Note Test operation cannot be executed if the FREE input is being ON. Be sure to execute after turning the signal OFF.

6.2 Starting, stopping

When either the FWD input or REV input is turned ON after setting the rotation speed, the motor will rotate at the specified speed.

If the signal (FWD input or REV input) which has been turned ON is turned OFF while the motor rotates, the motor will decelerate to a stop according to the specified deceleration time.

If the FWD input and REV input are turned ON simultaneously, the motor stops instantaneously.

FWD input	REV input	Motor shaft action
ON	OFF	Rotation in the forward direction
OFF	ON	Rotation in the reverse direction
OFF	OFF	Deceleration stop
ON	ON	Instantaneous stop

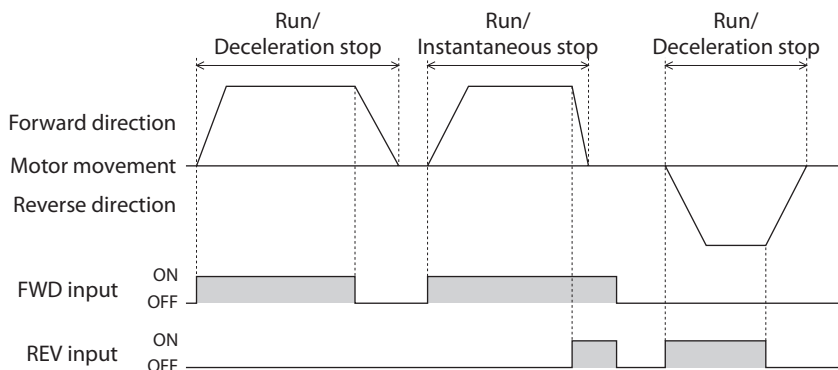

- Do not perform vertical drive (gravitational operation).
- Make sure that the motor case temperature does not exceed 90°C (194 °F) when operating the motor. Operating the motor in a state where the case temperature exceeds 90°C (194 °F) causes the lives of windings and ball bearings of the motor to shorten.

6.3 Setting the rotation speed

The rotation speed can be set using any of the following method (1), (2), or (3).

In the case of the combination type, the rotation speed of the gearhead output shaft varies depending on the gear ratio. This manual describes the rotation speed of the motor output shaft.

Setting range 50 Hz: 90 to 1400 r/min
60 Hz: 90 to 1600 r/min

If the product is operated at 50 Hz when the rotation speed exceeding 1400 r/min has been set, the motor will rotate around 1420 r/min although it is out of the setting range.

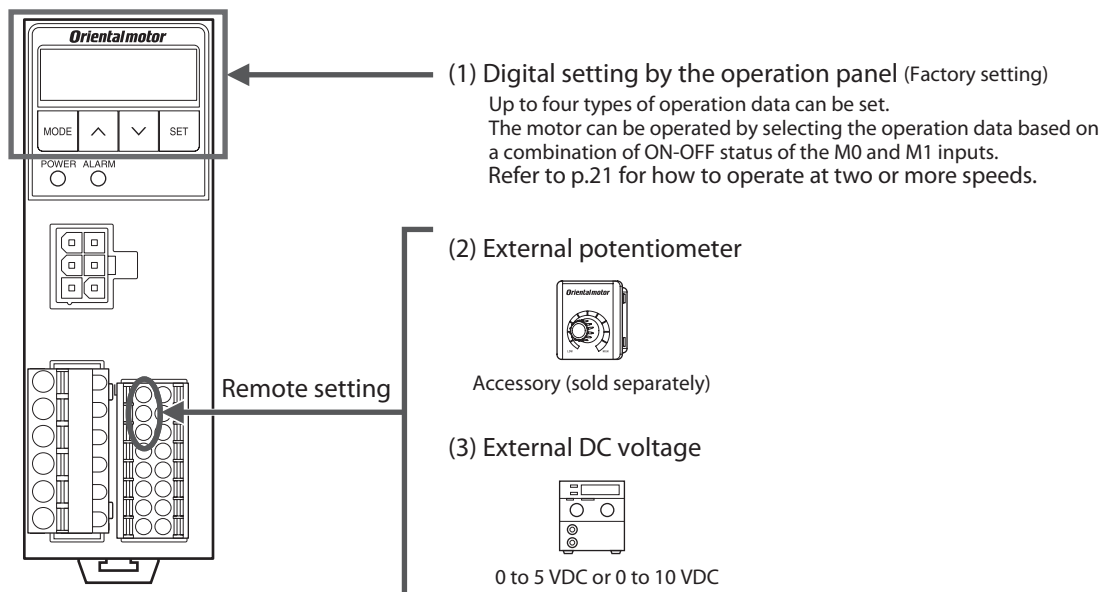

See the next page for the setting procedures and methods of (1), (2), and (3).

■ Setting method using the operation panel

The rotation speed can be set while rotating the motor, and it can also be set in the motor standstill state. This section explains how to set the rotation speed while rotating the motor as an example.

Example: Set the rotation speed to 1000 r/min from 0 r/min

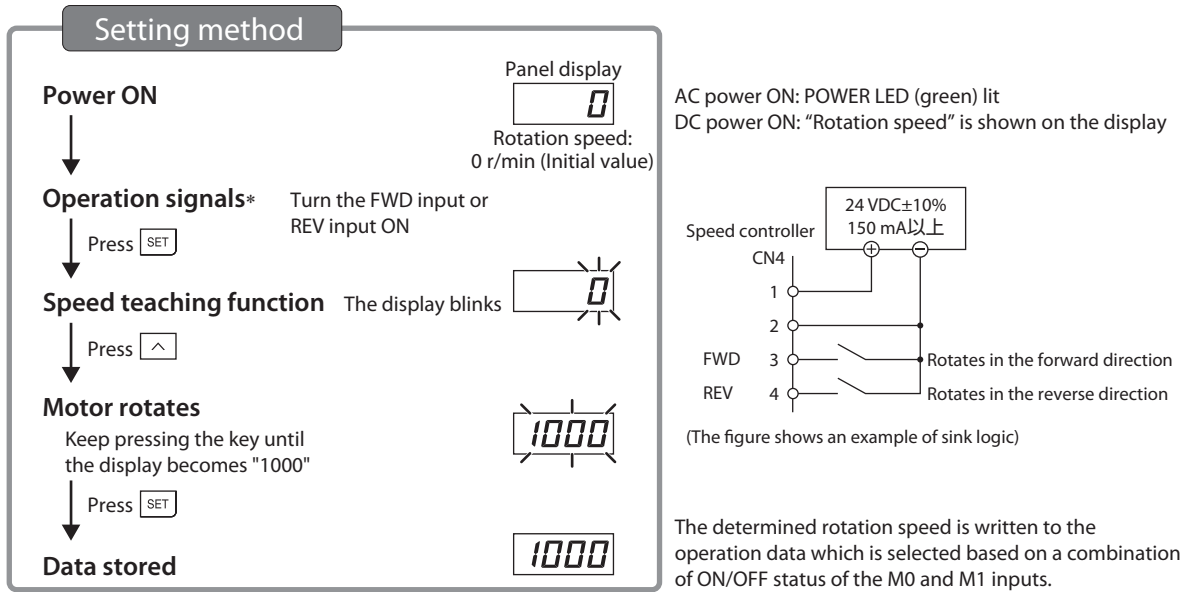

* If the rotation speed is already set, the motor rotates.

If both the FWD input and REV input are turned OFF, the rotation speed can be set in a state of motor standstill.

■ Remote setting method

The rotation speed can also be set remotely by the following two methods.

Set the "external speed command input" parameter to "ON (enable)" (initial value: OFF), and turn the M0 input and M1 input OFF. Refer to p.27 for how to set the parameter.

● Setting with external potentiometer (accessory)

Connect the external potentiometer to the CN4. Turning the external potentiometer in the clockwise direction increases the speed.

"External speed command voltage selection" parameter:
"0-5" (initial value)

* The figure and characteristics are an example when the external potentiometer **PAVR2-20K** (accessory) is used.

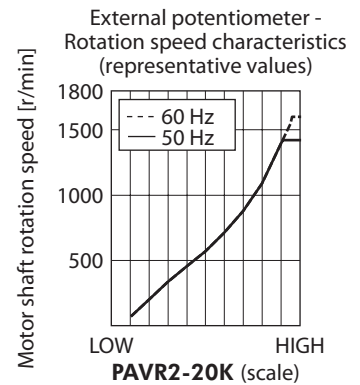
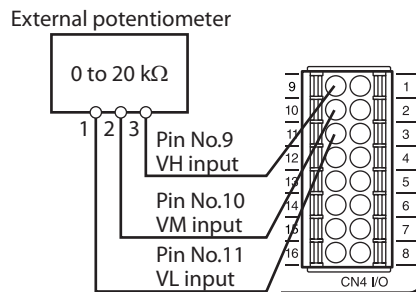

● Setting with external DC voltage

Connect an external DC power supply (0 to 5 VDC or 0 to 10 VDC) with reinforced insulation on its primary and secondary sides to the CN4.

"External speed command voltage selection" parameter:
"0 - 5" (initial value) for 0 to 5 VDC
"0 - 10" for 0 to 10 VDC

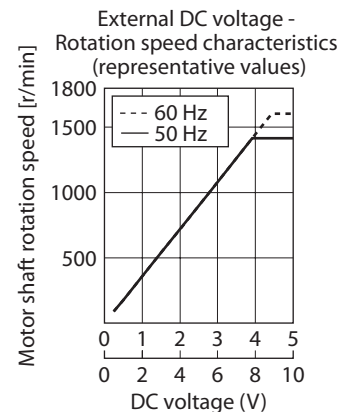
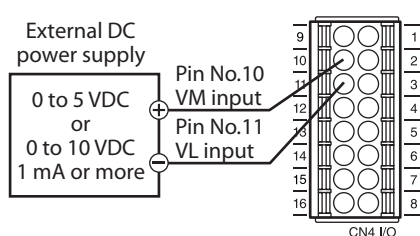

The input impedance between the VM input and VL input is approximately 11.3 kΩ.



Be sure to set the external DC voltage to 10 VDC or lower. When connecting the external DC power supply, make sure the polarities are correct. If the polarities are reversed, the speed controller may be damaged.

6.4 Setting the acceleration time and deceleration time

The acceleration time and deceleration time can be adjusted to prevent the load from receiving a shock upon starting, stopping, or changing in speed.

Refer to p.26 for how to set each operation data using the operation panel.

Setting range: 0 to 15.0 seconds

The actual acceleration time and deceleration time against the setting vary depending on the inertial load, frictional load, set rotation speed or motor output power.

If the deceleration time is set shorter than the coasting stop time, the motor will not stop at the specified time.

The setting method of the acceleration time and deceleration time varies depending on the setting method of the rotation speed.

• When the rotation speed is set by the operation panel

Set the time needed to reach the target speed from the present speed.

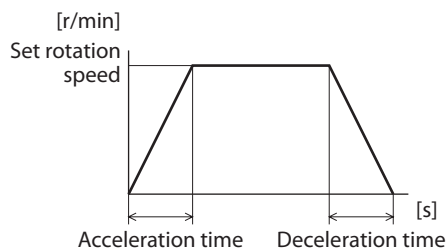

• When the rotation speed is set remotely

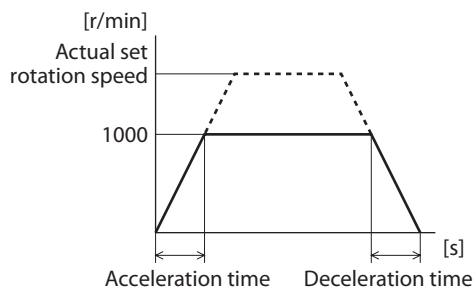

Set as the time needed for the motor to reach 1000 r/min from the standstill state.



6.5 Motor rotation direction

The rotation direction of the motor output shaft represents the direction when viewed from the motor output shaft. The rotation direction of the gearhead output shaft varies depending on the gear ratio of the gearhead.

Check the operating manual included with the motor.

	FWD input signal	REV input signal
Rotation direction	Clockwise 	Counterclockwise 

The rotation direction of the motor output shaft which rotates when the FWD input is turned ON can be changed with the "motor rotation direction" parameter.

Refer to p.27 for details.

6.6 Timing chart

This is an example of a timing chart for a basic operation.

Example: 1200 r/min is set in the operation data No.0, and 100 r/min is set in the operation data No.1.

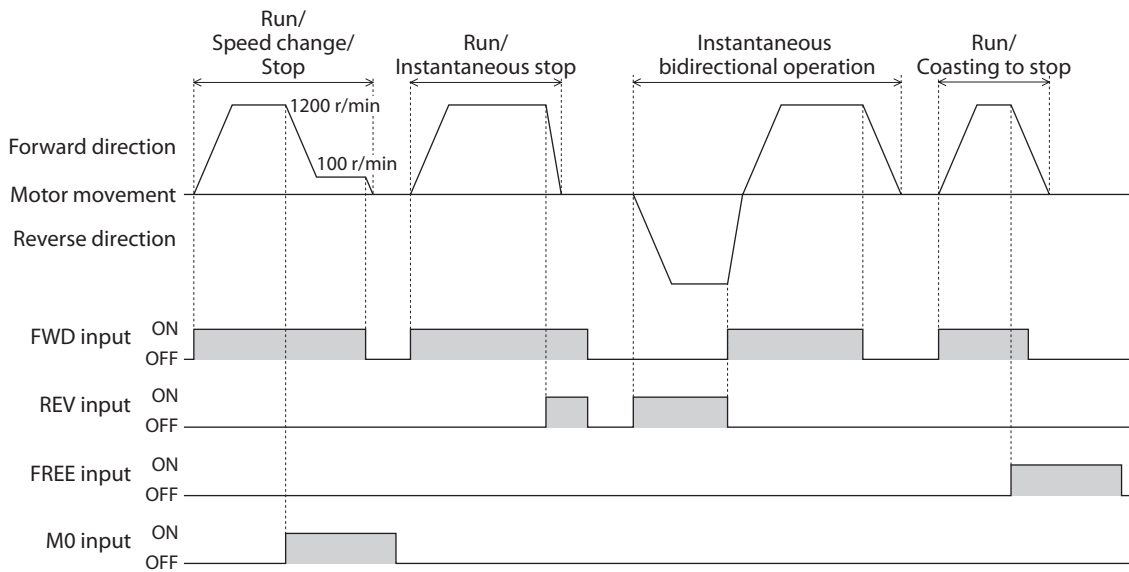

Note Make sure each signal remains ON for at least 10 ms.

6.7 Short time cycle operation and braking current

■ Repeated cycle of operation/instantaneous stop

If operation and instantaneous stop of the motor are repeated in short cycles, the motor temperature rise will be large.

Use the motor in a state where the motor case temperature does not exceed 90°C (194 °F).

Use the motor at the repetition cycle shown below.

6 W to 40 W: 2 seconds (operation 1 second, standstill 1 second)

60 W and 90 W: 4 seconds (operation 2 seconds, standstill 2 seconds)

Measure to check the motor case temperature using a thermometer, thermo tape, or thermocouple.

Note Make sure that the motor case temperature does not exceed 90°C (194 °F) when operating the motor. Operating the motor in a state where the case temperature exceeds 90°C (194 °F) causes the lives of windings and ball bearings of the motor to shorten.

■ Brake current

When the motor is instantaneously stopped, the large braking current shown in the table flows through the AC power lines for 0.4 seconds.

If the FWD input or REV input is turned OFF while the braking current flows, the braking current will stop flowing and the motor will rotate.

For capacitances of a breaker and AC power supply in equipment, select in consideration of the braking current (peak value) in the table.

Motor output power	Brake current (peak value)	
	Single-phase 100/110/115 VAC	Single-phase 200/220/230 VAC
6 W	2 A	1 A
15 W	4 A	3 A
25 W	8 A	4 A
40 W	12 A	7 A
60 W	21 A	10 A
90 W	29 A	13 A

Note Do not turn off the power supply while the braking current flows. Doing so may damage to the speed controller.

6.8 Operating at two or more speeds (multi-speed operation)

The multi-speed operation can be performed by setting the rotation speed and switching the ON-OFF status of the M0 and M1 inputs.

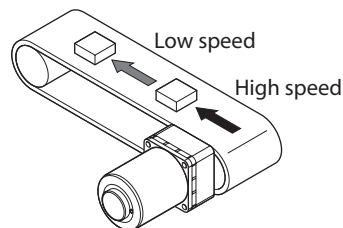

Data setting method (example: rotation speed)

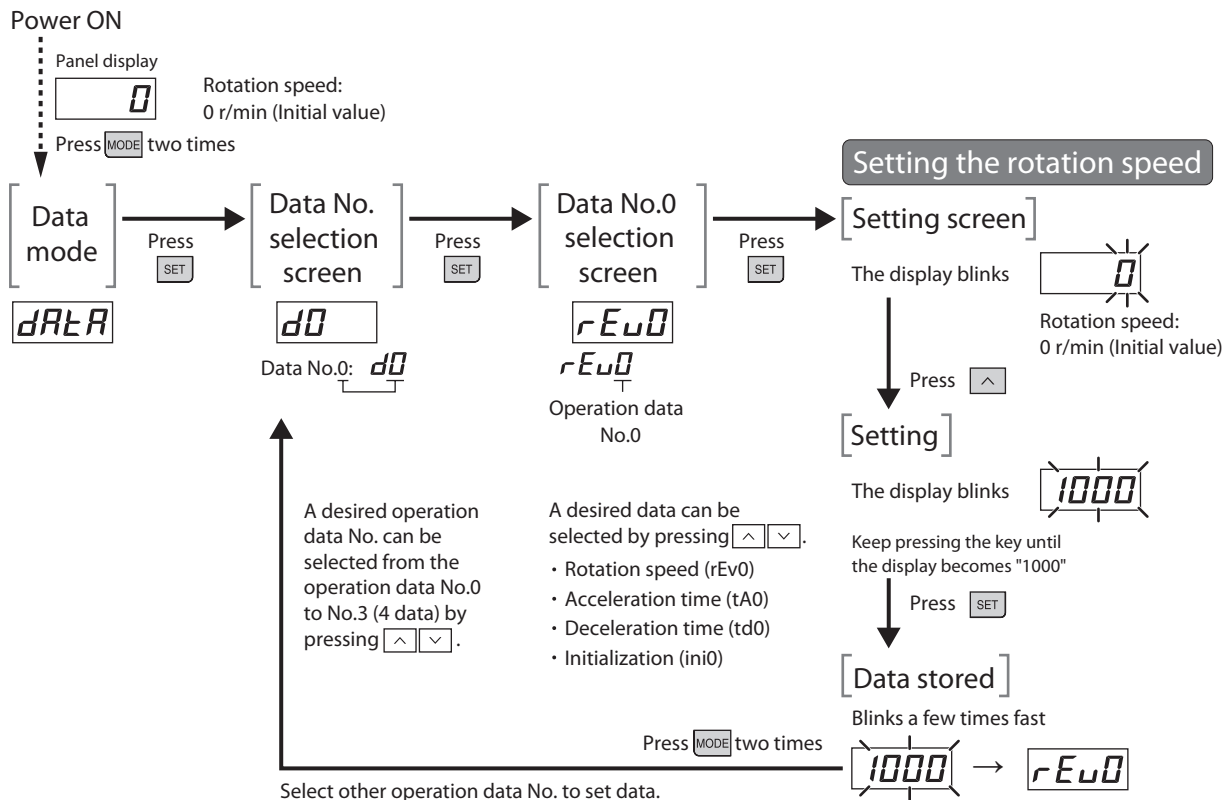

Refer to "7.2 Operation panel transitions" for transitions of the operation panel.

Operating method

Select any of the operation data No.0 to No.3 by switching the ON-OFF status of the M0 and M1 inputs, and operate the motor. The motor is operated using the rotation speed, acceleration time, and deceleration time in the selected operation data number.

- <Operation procedure>
1. Select the operation data number using the M0 and M1 inputs.
 2. When either the FWD input or REV input is turned ON, the motor rotates.
 3. Switch the operation data using the M0 and M1 inputs.
 4. When the FWD input or REV input which has been turned ON is turned OFF, the motor stops.

Operation data No.	M1	M0	Description
0	OFF	OFF	Operation panel setting/remote setting*
1	OFF	ON	Operation panel setting
2	ON	OFF	
3	ON	ON	

* When the "external speed command input" parameter is set to "ON (enable)" (initial value: OFF), the rotation speed can be set using an external potentiometer or external DC voltage.

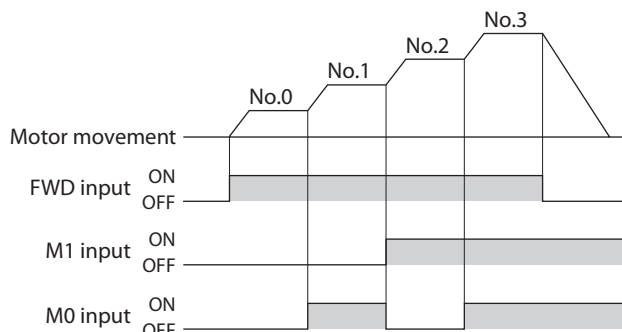

6.9 Adjusting the rotation speed of two or more motors by a single setting device (multi-motor control)

Two or more motors can be operated at the same speed using a single variable resistor or external DC voltage. Set the "external speed command input" parameter to "ON (enable)," and turn the M0 input and M1 input OFF. Refer to p.27 for parameter.

■ Adjusting the rotation speed using a variable resistor

Connect the speed controllers as shown below.

When performing multi-motor control using the variable resistor, the number of speed controllers should not exceed 20 units.

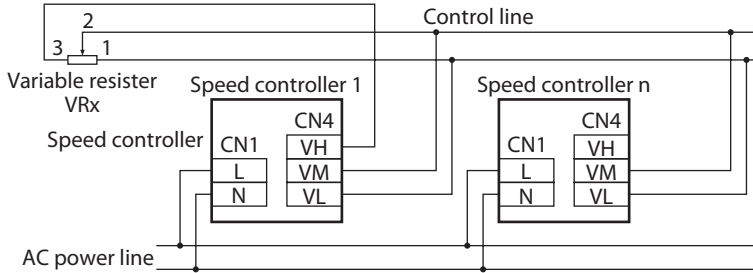

Resistance (VRx) when the number of speed controllers connected is n:

Resistance VRx (kΩ) = 20 kΩ/n, permissible dissipation (W) = n/4

Example: When two speed controllers are connected

Resistance VRx (kΩ) = 20 kΩ/2 = 10, permissible dissipation (W) = 2/4 = 1/2

■ Adjusting the rotation speed using external DC voltage

Connect the speed controllers as shown below.

The number of units connected may limit depending on the current capacity of the external DC power supply.

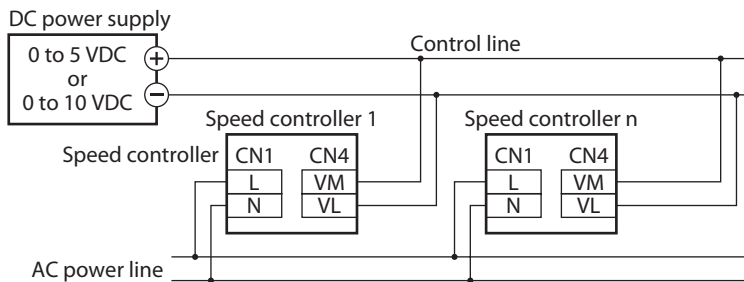

Current capacity of external DC power supply when the number of speed controllers connected is n:

Current capacity (mA) = 1 mA × n

Example: When two speed controllers are connected

Current capacity (mA) = 1 mA × 2 = 2

■ Adjusting the speed difference

To adjust the speed difference among the first motor and the second and subsequent motors, change the "external speed command offset" parameter of the speed controller. Refer to p.27 for parameter.

The speed difference can be adjusted by changing the "setting voltage - rotation speed characteristics" shown in the figure.

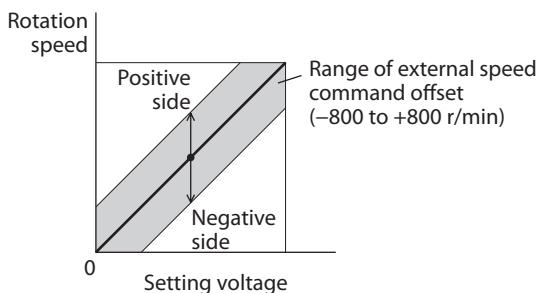

<Example>

- When the speed of the second motor is slower than that of the first motor, set the value for the positive side (0 to +800 r/min) in the "external speed command offset" parameter of the second speed controller.

7 Function

7.1 Functions list

The following functions are available for this product.

Function	Description	Reference page		
Display	Rotation speed	Displays the rotation speed of the motor output shaft.		
		Displays the rotation speed of the gearhead output shaft.		
		Fixes the display of the lowest digit to "0."		
	Other speeds	Displays the transfer speed of the conveyor drive.	27	
		Displays the increased speed.		
	Operation data No.	Displays the operation data number.	26	
	Alarm	Checks the alarm information.		
		Checks the alarm records.		
	Warning	Checks the warning information.		
		Checks the warning records.		
I/O monitor	Checks the ON-OFF status of the input signals.			
	Checks the ON-OFF status of the output signals.			
Basic	Setting the rotation speed	Sets the rotation speed.	26	
		Sets by changing the speed while the motor rotates.	18	
		Sets the rotation speed using the external potentiometer.	18	
		Sets the rotation speed using the external DC voltage.		
		Selects the setting voltage of the rotation speed. (0 to 5 VDC or 0 to 10 VDC)	27	
	Checks the setting value (voltage) from outside.	26		
	Setting of acceleration/ deceleration time		Sets the acceleration time and deceleration time.	
	Multi-speed operation		Operates at two or more speeds	21
	Test operation		Starts and stops the motor.	16
	Alarm reset		Resets the alarm that is present.	30
Application	Action when the power is turned on	Starts and stops the motor by ON-OFF control of the AC power supply. (Sets the "prevention of operation at power-on" parameter to disable)	27	
	Offset setting	Adjusts the speed difference when performing multi-motor control.	22	
	Limitation of the setting range	Limits the setting range of the rotation speed (Upper limit, lower limit)	28	
	Changing the function for I/O signals	Changes the functions of the input signals (6 signals).		
		Changes the functions of the output signals (2 signals).	29	
	Changing the rotation direction	Changes the rotation direction when the FWD input is turned ON.	27	
"Motor lock" alarm	Changes the alarm detection time.			
Initialization	Operation data	Initializes the operation data.	26	
	Parameter	Initializes the parameter.	27	
Operation lock function	Blocks so that the data will not be changed.	29		

7.2 Operation panel transitions

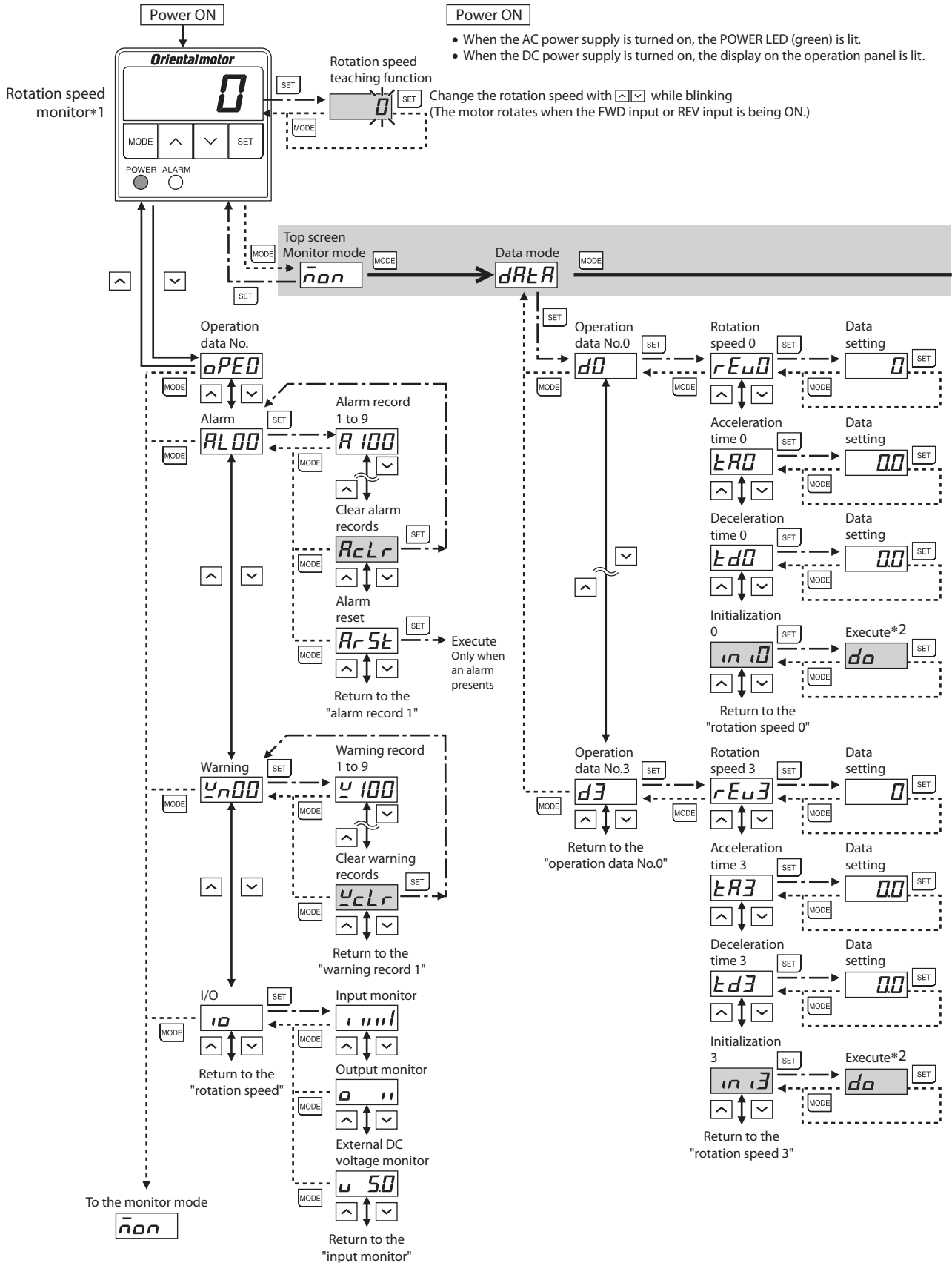

*1 When the speed reduction ratio or speed increasing ratio is being set, the converted speed is displayed.

*2 The setting change or execution is not possible while operating the motor. "Err" will be displayed.

• If operations are limited by the edit lock function, the screens in gray color are not displayed.

• The display blinks in the data setting screen. If SET is pressed after the setting is changed, the display blinks fast (a few times), and the new setting is stored.

Overview of the operation panel

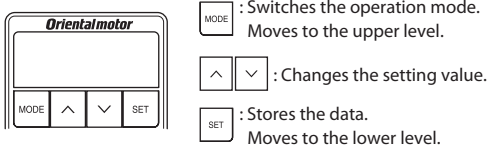

Edit lock function

The operation panel can be locked so that the data cannot be changed. Perform the following action on the top screen in each mode.

- Lock: Press and hold MODE for 5 seconds LF
- Reset: Press and hold MODE for 5 seconds UnLF

When the data or parameter is edited while locking, "LF" is displayed for about 1 second.

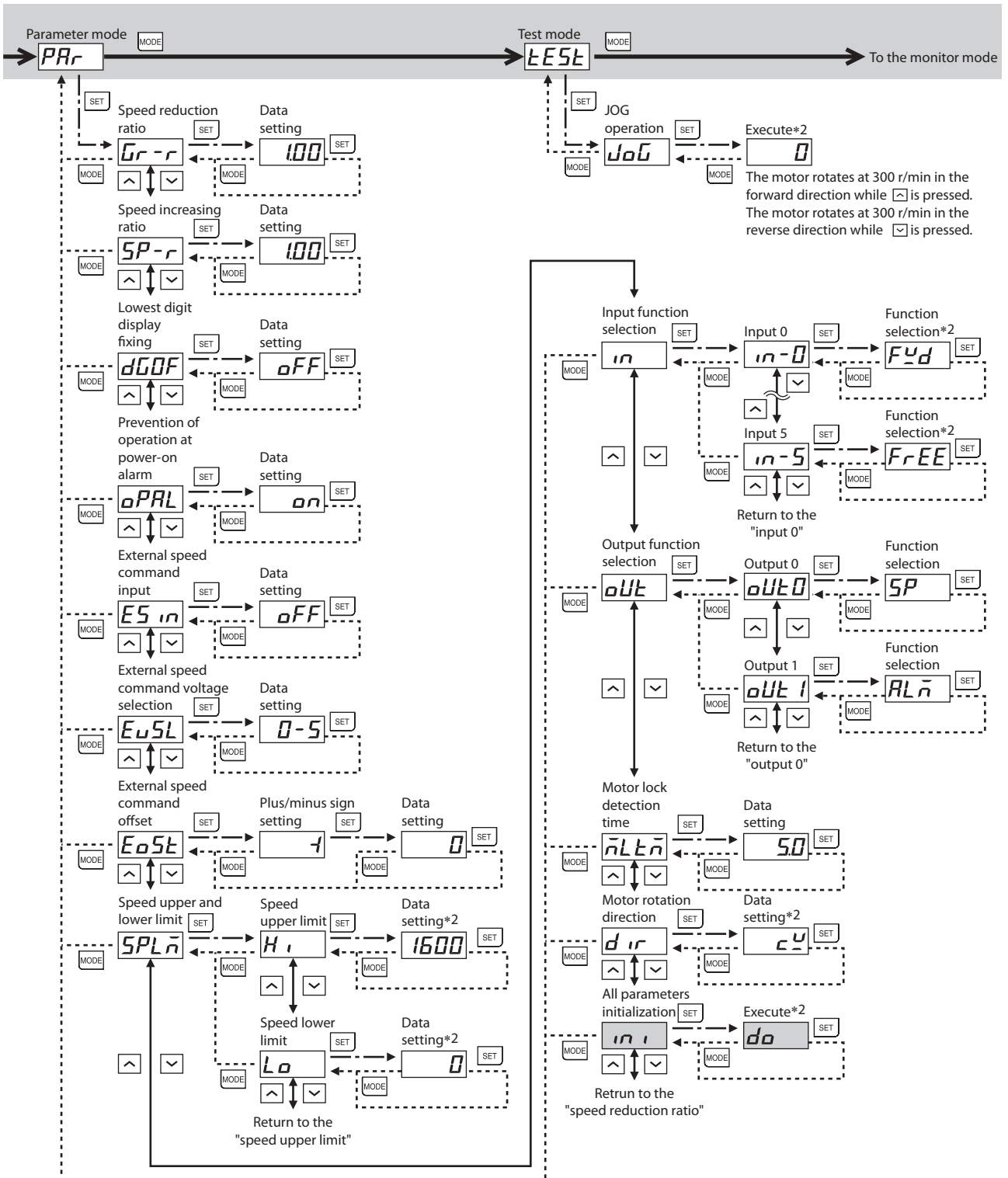

7.3 Items that can be monitored

Operation mode: Monitor mode

Item	Display	Monitor item
Rotation speed		<ul style="list-style-type: none"> The rotation speed of the motor shaft is displayed. When the "speed reduction ratio" parameter is set, the rotation speed of the gear output shaft or the conveyor transfer speed is displayed. When the "speed increasing ratio" parameter is set, the rotation speed being increased by the external mechanism is displayed.
Operation data No.		The operation data number presently selected is displayed.
Alarm		<p>When an alarm generates, the corresponding alarm code is displayed. You can also check and clear alarm records in addition to resetting alarms. Refer to p.30 for alarm types, alarm codes and alarm reset.</p> <ul style="list-style-type: none"> Alarm records <p>Alarm code 1 to 9: Up to the nine most recent alarm records</p> Alarm reset* <p>* Only available when an alarm generates.</p>
Warning		<p>When a warning generates, the corresponding warning code is displayed. You can also check and clear warning records. Refer to p.32 for warning types and warning codes.</p> <ul style="list-style-type: none"> Warning records <p>Warning code 1 to 9: Up to the nine most recent alarm records</p>
I/O monitor		<p>The ON-OFF status of each I/O signal for the speed controller can be checked. If the signal is ON, the corresponding digit is lit. If the signal is OFF, the digit is unlit. Also, the setting voltage of the external speed setter can be checked.</p> <ul style="list-style-type: none"> Input signals Output signals* <p>* The alarm output is being ON while the product operates normally.</p>

7.4 Setting the operation data

Up to 4 operation data can be set using the operation panel, and the motor can be operated by selecting the data based on a combination of the ON-OFF status of the M0 and M1 inputs.

Refer to p.21 for the setting procedure and operating method.

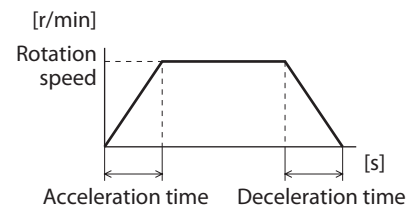

Operation mode: Data mode

Item	Display *2	Description	Setting range	Initial value
Rotation speed *1		Sets the rotation speed. Set the rotation speed of the motor output shaft.	50 Hz: 0, 90 to 1400 r/min 60 Hz: 0, 90 to 1600 r/min	0
Acceleration time		Sets the acceleration time and deceleration time. Refer to p.19 for details.	0.0 to 15.0 s	0.0
Deceleration time				
Initialization		Restores the operation data to the initial value.	-	-

*1 If the product is operated at 50 Hz when the rotation speed exceeding 1400 r/min has been set, the motor will rotate around 1420 r/min although it is out of the setting range.

*2 The digit (0 to 3), which represents the operation data number, will be displayed at the end of the string.

Operation data No.0:

Note Do not turn off the control DC power supply while the display is blinking after executing the data setting or initialization. Doing so may damage the data.

7.5 Setting the parameters

■ Parameter list

Operation mode: Parameter mode

Item	Display	Description	Setting range	Initial value	
Speed reduction ratio	$Gr-r$	Setting the speed reduction ratio with respect to the rotation speed of the motor output shaft can display the speed being converted by the speed reduction ratio. If the conveyor speed reduction ratio is calculated and input, the conveyor transfer speed can also be displayed.	1.00 to 9999	1.00	
Speed increasing ratio	$SP-r$	When the motor rotation speed is increased using an external mechanism or others, the converted speed can be displayed.	1.00 to 5.00	1.00	
Lowest digit display fixing	$dGDF$	In the speed stability of this product, the display of the last digit on the rotation speed monitor may not be stable. If the last digit is fixed to "0," the display status becomes stable.	Fixed Not fixed	on OFF OFF	
Prevention of operation at power-on alarm	$oPRL$	If the power supply is turned on when the FWD input or REV input is being ON, an alarm will generate. When starting and stopping the motor by ON-OFF control of the power supply, set this parameter to OFF (disable).	ON (Enable) OFF (Disable)	on OFF on	
External speed command input	$ES in$	Selects the setting method of the rotation speed for the operation data No.0. When setting the rotation speed using an external potentiometer or external DC voltage, set the external speed command input to ON (enable). When this parameter is set to OFF (disable), the rotation speed can be set with the operation panel.	ON (Enable) OFF (Disable)	on OFF OFF	
External speed command voltage selection	$EuSL$	Selects "0 to 5 VDC" or "0 to 10 VDC" in accordance with the external DC voltage used at the time of the speed setting.	0 to 10 VDC 0 to 5 VDC	$0-10$ $0-5$ $0-5$	
External speed command offset	$EoSt$	Adjusts the speed difference among motors when performing multi-motor control.	-800 to +800 r/min	0	
Speed upper and lower limit $SPL\bar{n}$	Speed upper limit Hl	Sets the upper limit of the rotation speed.	0, 90 to 1600 r/min	1600	
	Speed lower limit Lo	Sets the lower limit of the rotation speed.		0	
Input function selection in	IN0	Input signals assigned to input terminals can be changed. Refer to p.29 for details.	FWD	$Fy\bar{d}$	$Fy\bar{d}$
	IN1		REV	rEu	rEu
	IN2		MO	$\bar{n}0$	$\bar{n}0$
	IN3		M1	$\bar{n}1$	$\bar{n}1$
	IN4		ALARM-RESET	$RrSt$	$RrSt$
	IN5		FREE	$FrEE$	$FrEE$
Output function selection out	OUT0	Output signals assigned to output terminals can be changed. Refer to p.29 for details.	SPEED-OUT	SP	SP
	OUT1		ALARM-OUT	$AL\bar{n}$	$AL\bar{n}$
			TH-OUT	$tH-o$	
			WNG	YnG	
Motor lock detection time	$\bar{n}L\bar{t}\bar{n}$	Sets the time needed to output an alarm after detecting the lock state of the motor or the disconnection of the motor cable.	1.0 to 5.0 seconds	5.0	
Motor rotation direction	$d ir$	Sets the motor rotation direction when inputting the FWD input.	CW CCW	$c\bar{u}$ $c\bar{c}\bar{u}$ $c\bar{u}$	
All parameters initialization	$in i$	Restores the value set in the parameter mode to the initial value.	-	-	

Note

- Do not turn off the control DC power supply while the display is blinking after executing the data setting or initialization. Doing so may damage the data.
- Setting the speed increasing ratio to 1.00 causes the speed reduction ratio to enable. Setting the speed increasing ratio to other than 1.00 causes the speed increasing ratio to enable.

■ **Displayed digit number when setting the speed reduction ratio or speed increasing ratio**

The number of significant figures for the integer part is changed if the speed reduction ratio or speed increasing ratio is set, so the digit number displayed on the panel will also be changed.

Setting value of the speed reduction ratio and speed increasing ratio	Display digit on the panel
1.00 to 9.99	0 to 9999
10.00 to 99.99	0.0 to 999.9
100.0 to 999.9	0.00 to 99.99
1000 or more	0.000 to 9.999

■ **How to calculate the speed reduction ratio when displaying the conveyor transfer speed**

To display the conveyor transfer speed, calculate the conveyor speed reduction ratio using the formula below, and set to the "speed reduction ratio" parameter.

$$\text{Conveyor speed reduction ratio} = \frac{1}{\text{Feed rate per motor revolution}} = \frac{\text{Gearhead gear ratio}}{\text{Pulley diameter [m]} \times \pi}$$

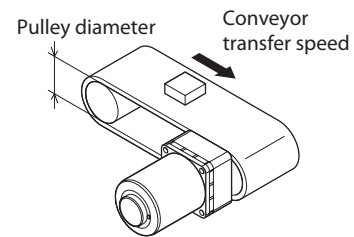

When the calculated conveyor speed reduction ratio is used, the conveyor transfer speed is converted as follows:

$$\text{Conveyor transfer speed [m/min]} = \frac{\text{Rotation speed of motor output shaft [r/min]}}{\text{Conveyor speed reduction ratio}}$$

Example: The pulley diameter is 0.1 m and gear ratio of the gear head is 25

$$\text{Conveyor speed reduction ratio} = \frac{\text{Gearhead gear ratio}}{\text{Pulley diameter [m]} \times \pi} = \frac{25}{0.1 \text{ [m]} \times \pi} \cong 79.6$$

From the conversion formula, the conveyor speed reduction ratio is calculated as 79.6 in this example. If the speed reduction ratio is 79.6 and the rotation speed of the motor is 1300 r/min, the conveyor transfer speed is converted as follows:

$$\text{Conveyor transfer speed [m/min]} = \frac{1300}{79.6} \cong 16.3 \quad \text{Accordingly, "16.3" is shown on the display.}$$

■ **Limits the setting range of the rotation speed**

The setting range of the rotation speed is set to 0 to 1600 r/min at the time of shipment. This setting range can be changed to limit.

● **Speed upper limit**

Set the upper limit value of the rotation speed in the "speed upper limit" of the "speed upper and lower limit" parameter. The rotation speed exceeding the "speed upper limit" cannot be set in the rotation speed of the operation data. The operation data, which is already set the rotation speed exceeding the "speed upper limit," will be overwritten by the rotation speed set in the "speed upper limit."

● **Speed lower limit**

Set the lower limit value of the rotation speed in the "speed lower limit" of the "speed upper and lower limit" parameter. The rotation speed below the "speed lower limit" cannot be set in the rotation speed of the operation data. The operation data, which is already set the rotation speed below the "speed lower limit," will be overwritten by the rotation speed set in the "speed lower limit."

Setting range of the rotation speed

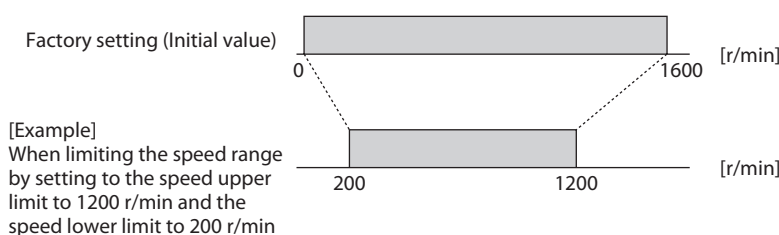

■ Description of I/O signals that can be assigned

6 input signals and 2 output signals out of the following signals can be assigned.

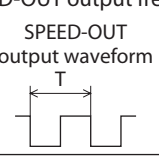
Signal	Terminal	Signal name	Description
Input	IN0 IN1 IN2 IN3 IN4 IN5	FWD	When the FWD input is turned ON, the motor output shaft rotates in the forward direction according to the set acceleration time. When the REV input is turned ON, the motor output shaft rotates in the reverse direction. When the input is turned OFF, the motor will stop according to the set deceleration time.
		REV	If both the FWD input and REV input are turned ON, the motor stops instantaneously. (The rotation direction can be changed with the parameter setting.)
		M0	These signals are used to select the operation data.
		M1	Select the operation data to execute from 4 data by a combination of these signals.
		ALARM-RESET	This signal is used to reset the present alarm generated by which the protective function of the speed controller was activated. Be sure to remove the cause of the alarm before turning the ALARM-RESET input ON. Refer to p.31 for the resetting methods and timing chart.
		FREE	If the FREE input is turned ON while the motor is operated, the motor will coast to a stop. While the FREE input is being ON, the motor will not rotate even if the FWD input or REV input is turned ON.
		EXT-ERROR	If this signal is turned OFF, an alarm generates to stop the motor. Then "ALBE" will be shown on the display (normally closed).
Output	OUT0 OUT1	SPEED-OUT	Pulse signals of 12 pulses are output while the motor output shaft rotates by one revolution in synchronization with the motor rotation. The motor rotation speed can be calculated by checking the SPEED-OUT output frequency. $\text{Motor rotation speed [r/min]} = \frac{\text{SPEED-OUT output frequency [Hz]} \times 60}{12}$ $\text{SPEED-OUT output frequency} = \frac{1}{T}$ 
		ALARM-OUT	This signal is turned OFF when an alarm generates (normally closed).
		TH-OUT	When the built-in overheat protection device (thermal protector) of the motor is activated (OPEN), this output signal will be turned ON. If the motor temperature drops and the thermal protector is returned (CLOSE), this output signal will be turned OFF. (It is enabled while the AC power is input.)
		WNG	This signal is output when a warning generates. When the warning is released, it will automatically be turned OFF.

7.6 Prohibiting data editing

This is a function to prevent the set data from editing or clearing by mistake.

Operation data (rotation speed etc.) and parameters cannot be changed while the edit lock function is enabled.

• Setting of the edit lock function

Press MODE for minimum 5 seconds on the top screen.
"LK" is displayed and the edit lock function will be enabled.

LK

• Resetting the edit lock function

Press MODE for minimum 5 seconds on the top screen.
"UnLK" is displayed and the edit lock function will be released.

UnLK

• Display while the edit lock function is enabled

If the setting value of the operation data or parameter is tried to change while the edit lock function is enabled, "LK" is displayed for about one second.

8 Alarms

The speed controller provides alarms that are designed to protect the speed controller from overheating, poor connection, error in operation, etc. (protective functions), as well as warnings that are output before the corresponding alarms generate (warning functions).

8.1 Alarms

If a protective function is activated and an alarm generates, the motor will coast to a stop.

At the same time, the alarm output is turned OFF, and the ALARM LED will be lit (red) in addition that the alarm code is shown on the display.

The alarm type can be checked by the alarm code.

■ Alarm lists

AL26 <ul style="list-style-type: none"> ● Motor overheat ● Motor poor connection 	<ul style="list-style-type: none"> ● The motor abnormally produced heat from any cause, and a built-in overheat protection device (thermal protector) of the motor was activated (OPEN). ● The motor power line of the motor cable occurred disconnection or poor connection. 	<ul style="list-style-type: none"> ● Decrease the load. ● Improve the operation conditions such as the acceleration time or deceleration time. ● Check the motor cable or connection of the connector part.
AL30 <ul style="list-style-type: none"> ● Motor lock ● Motor poor connection 	<ul style="list-style-type: none"> ● The motor output shaft was locked more than the time set in the "motor lock detection time" parameter. ● The rate generator lead wire of the motor cable occurred disconnection or poor connection. ● The capacitor was not connected or occurred poor connection. 	<ul style="list-style-type: none"> ● Decrease the load. ● Check the connections of the motor cable, connector part and capacitor.
AL31 Overspeed	The rotation speed of the motor output shaft exceeded approximately 2300 r/min.	Check whether the motor is rotated by a load or external force.
AL41 EEPROM error *1	<ul style="list-style-type: none"> ● The control DC power supply was turned off while the data setting or initialization was executed. ● The stored data was damaged. ● Data became no longer writable or readable. 	<ul style="list-style-type: none"> ● Initialize the data and parameters. ● If the alarm cannot be cleared even when the power is restarted, contact your nearest Oriental Motor sales office.
AL46 Prevention of operation at power-on *2	The power supply was turned on while the FWD input or REV input was being ON.	If the FWD input or REV input which has been turned ON is turned OFF, the alarm will be reset.
AL6E External stop *3	The EXT-ERROR input was turned OFF.	Check the EXT-ERROR input.

*1 This alarm cannot be reset by the ALARM-RESET input.

*2 If the "prevention of operation at power-on alarm" parameter is set to disable, this alarm will not generate. (Initial setting: Enable)

*3 Only when the EXT-ERROR is assigned.

● "Motor overheat" alarm

Motors with an output power of 15 W to 90 W contain an automatic return type thermal protector in the motor windings. If the motor internal temperature exceeds the specified value, the thermal protector will be activated (OPEN), and the "motor overheat" alarm will be generated. If the TH-OUT output is assigned to the output signal, the status (OPEN/CLOSE) of the built-in thermal protector can be detected.

Motors with an output power of 6 W are adopted impedance protection for overheat protection so that the temperature will not rise above a certain level.

● "Overspeed" alarm

This product is equipped a function to suppress the generation of the "overspeed" alarm.

If the rotation speed of the motor output shaft is exceeded approximately 2100 r/min, the brake current is automatically flowed to decelerate the motor.

■ Alarm reset

Before resetting an alarm by any of the reset operations specified below, always remove the cause of the alarm and check the motor standstill state after turning the FWD and REV inputs OFF.

- Turn the ALARM-RESET input ON. (The alarm will be reset at the ON edge of the input.)
- Execute an alarm reset using the operation panel.
- Turn on the control DC power again.

- Note**
- If the product does not operate properly after the control DC power supply is turned on again, internal circuit damage is suspected. Contact your nearest Oriental Motor sales office.
 - Continuing the operation without removing the cause of the alarm may cause damage to equipment.
 - Do not turn off the control DC power supply for at least 1 second after an alarm is generated. Doing so may damage the data.

• Reset using the ALARM-RESET input

Turn both the FWD input and REV input OFF, and remove the cause of the alarm before turning the ALARM-RESET input ON. The ALARM-RESET input is disabled while the FWD input or REV input is being ON. The figure shows an example for the FWD input.

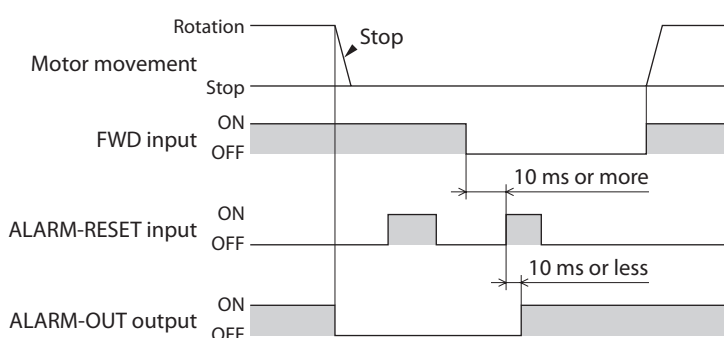

• Reset using the operation panel

Turn both the FWD input and REV input OFF, and remove the cause of the alarm before resetting the alarm with the operation panel.

An alarm is being generated.

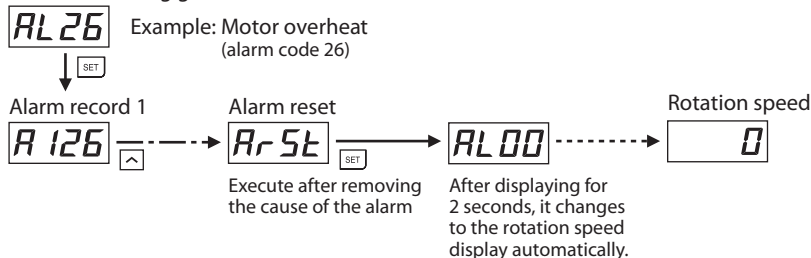

■ Alarm records

Up to 9 generated alarms are saved in the non-volatile memory in order of the latest to oldest. When clearing the alarm records, perform the alarm record clear on the monitor mode.

- Note**
- Do not turn off the control DC power supply while alarm records are being cleared (=while the display is blinking). Doing so may damage the data.

8.2 Warnings

The warning types and records can be displayed on the monitor mode.

When a warning generates, the WNG output is turned ON. The WNG output is not assigned to the output terminal at the time of shipment. Refer to "Description of I/O signals that can be assigned" on p.29.

The warning records will be cleared by turning off the control DC power supply.

■ Warning list

Warning code	Warning type	Motor movement	Generation condition	Remedial action
<i>Уn30</i>	Motor lock	Continue to operate	The motor output shaft was locked for one second or more.	Check the load condition.
<i>Уn6c</i>	Operation error	Stop	When the input terminal is ON, the FWD input or REV input was assigned using the "input function selection" parameter.	When assigning the FWD input or REV input, check that the input terminal to be assigned is being OFF.
			When moved from the test mode to any of other modes after JOG operation was executed, the FWD input or REV input was being ON.	Turn both the FWD input and REV input OFF.

9 Troubleshooting

During motor operation, the motor or speed controller may fail to function properly due to an improper rotation speed setting or wiring. When the motor cannot be operated properly, refer to the contents provided in this chapter and take appropriate action.

If the problem persists, contact your nearest Oriental Motor sales office.

Note Certain items must be checked with the power on. Perform inspections carefully not to touch the live part such as connection part of the motor and speed controller.

Possible cause	Remedial action
----------------	-----------------

● **The motor does not rotate.**

Both the FWD input and REV input are being OFF.	Turn either the FWD input or REV input ON.
Both the FWD input and REV input are being ON.	
The rotation speed has not set in the operation data.	Set the operation data. The rotation speed is required to set before operating the motor.
Although the external speed setter is used to set the rotation speed, the setting in the "external speed command input" parameter has not changed.	Set the "external speed command input" parameter to "ON (enable)."
The AC power supply, motor, or capacitor has not connected properly.	Check the connection.
The FREE input is being ON.	Turn the FREE input OFF.

● **The speed cannot be changed. The motor does not rotate at the set speed.**

The operation data selection input has not been switched.	Check whether the M0 input and M1 input is switched correctly.
When the external speed setter is used, both the M0 and M1 inputs are not turned OFF.	Turn the M0 and M1 inputs OFF.
When the external speed setter is used, the "external speed command input" parameter has not changed.	Set the "external speed command input" parameter to "ON (enable)."
The setting range of the rotation speed is limited.	Check the setting for the "speed upper limit" and "speed lower limit" parameters.

● **The motor rotates in the opposite direction against the specified direction.**

The FWD input and REV input are connected wrongly or otherwise not connected correctly.	Check the connection of the FWD input and REV input.
The gearhead that rotates in the opposite direction to the motor rotation direction is used.	Reverse the FWD input and REV input operations. Check the operating manual included with the motor for the rotation direction of the gearhead output shaft.
	Change the setting with the "motor rotation direction" parameter.
The setting for the "motor rotation direction" parameter is changed.	Change the setting with the "motor rotation direction" parameter.

● **The setting cannot be performed using the operation panel**

The edit lock function has been enabled.	Release the edit lock function.
--	---------------------------------

● **Motor operation is unstable. Motor vibration is too large.**

Effect of electrical noise.	Refer to "12.5 Installing and wiring in compliance with EMC Directive" on p.37 for the noise elimination measures.
-----------------------------	--

● **The motor does not start instantaneously.**

The acceleration time is too long.	Adjust the acceleration time.
Load inertia may be excessive.	Reduce the load inertia.
A load may be excessive.	Reduce the load.

● **The motor rotates even if the speed command has not input.**

The speed has been set in the "speed lower limit" parameter.	Set the value in the "speed lower limit" parameter to "0."
--	--

● **The alarm code is displayed**

Refer to "8.1 Alarms" on p.30".

10 Maintenance and inspection

10.1 Inspection

It is recommended that periodic inspections for the items listed below are conducted after each operation of the motor. If an abnormal condition is noted, discontinue any use and contact your nearest Oriental Motor sales office.



- Conduct the insulation resistance measurement or dielectric strength test separately on the motor and the speed controller.
Conducting the insulation resistance measurement or dielectric strength test with the motor and speed controller connected may result in damage to the product.
- The speed controller uses semiconductor elements. So be extremely careful when handling them. Static electricity may damage the speed controller.

■ Inspection item

- Check if any of the mounting screws for the motor and gearhead is loose.
- Check if the bearing part (ball bearings) of the motor generates unusual noises.
- Check if the bearing part (ball bearings) or gear meshing part of the gearhead generates unusual noises.
- Check if the output shaft of the motor and gearhead and a load shaft are out of alignment.
- Check if a damage or stress is applied on the cable, or the connection part between the motor and speed controller is loose.
- Check if the openings in the speed controller are clogged.
- Check if any of the speed controller connectors is loose.
- Check if there is any abnormality or unusual smell inside the speed controller.

10.2 Warranty

Check on the Oriental Motor Website for the product warranty.

10.3 Disposal

Dispose the product correctly in accordance with laws and regulations, or instructions of local governments.

11 Accessories (sold separately)

■ Connection cable

These cables are used to extend the wiring distance between the speed controller and motor. The connection cable can be connected up to 3 pieces.

Flexible connection cables are also available.

Maximum extension distance between the motor and speed controller: 10.5 m (34.4 ft.) [including 0.5 m (1.6 ft.) of the motor cable]

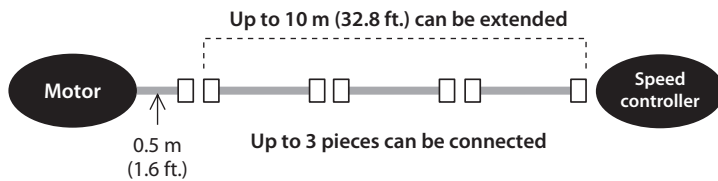

• Connection cable

Length	Model
1 m (3.3 ft.)	CC01SC
2 m (6.6 ft.)	CC02SC
3 m (9.8 ft.)	CC03SC
5 m (16.4 ft.)	CC05SC
10 m (32.8 ft.)	CC10SC

• Flexible connection cable

Length	Model
1 m (3.3 ft.)	CC01SCR
2 m (6.6 ft.)	CC02SCR
3 m (9.8 ft.)	CC03SCR
5 m (16.4 ft.)	CC05SCR
10 m (32.8 ft.)	CC10SCR

■ General purpose cables for I/O signals

These cables are convenient to connect I/O signals of the speed controller. Cables up to 2 m (6.6 ft.) are provided.

Length	Model	
	16 cores	12 cores
1 m (3.3 ft.)	CC16D010B-1	CC12D010B-1
2 m (6.6 ft.)	CC16D020B-1	CC12D020B-1

■ External potentiometer

This potentiometer is used to set and adjust the motor rotation speed remotely.

Model: **PAVR2-20K**

Couplings and mounting brackets are provided as accessories (sold separately). Check on the Oriental Motor Website for the product specifications.

12 Regulations and standards

12.1 UL Standards, CSA Standards

This product is recognized by UL under the UL and CSA Standards.

Applicable standards	Certification body/Standards file number
UL 508 CSA C22.2 No.14	UL/UL File No.E91291

12.2 EU Directives

■ CE Marking

This product is affixed the CE Marking under the Low Voltage Directive and EMC Directive.

● Low Voltage Directive

- This product is designed and manufactured to be incorporated in equipment.
- This product cannot be used in IT power distribution systems.
- Install the product inside an enclosure in order to avoid contact with hands.
- Securely ground the Protective Earth Terminal of the motor.
- Isolate the motor cable, power-supply cable and other drive cables from the signal cables (CN4) by means of double insulation.

Applicable Standards

- EN 50178

Installation conditions (EN Standards)

- Overvoltage category: II
- Pollution degree: 2
- Protection against electric shock: Class II equipment

If the overvoltage category III and pollution degree 3 are required for the equipment, install the motor and speed controller in an enclosure whose degree of protection is equivalent to IP54 or higher, and supply a rated voltage via the insulation transformer.

● EMC Directive

This product has received EMC compliance under the conditions specified in "Example of installation and wiring" on p.38. The final level of conformance of your mechanical equipment to the EMC Directive will vary depending on such factors as the control system equipment used with the motor and speed controller, configuration of electrical parts, wiring, layout and hazard level. It therefore must be verified through conducting EMC measures on your mechanical equipment.

Applicable Standards

EMI	Emission Tests	EN 61000-6-4
	Harmonics Current Test	EN 61000-3-2
	Voltage Fluctuations Test	EN 61000-3-3
EMS	Immunity Tests	EN 61000-6-2

This type of PDS is not intended to be used on a low-voltage public network which supplies domestic premises; radio frequency interference is expected if used on such a network.

12.3 Republic of Korea, Radio Waves Act

KC Mark is affixed to this product under the Radio Waves Act, the republic of Korea.

12.4 RoHS Directive

The products do not contain the substances exceeding the restriction values of RoHS Directive (2011/65/EU).

12.5 Installing and wiring in compliance with EMC Directive

The EMC Directive requires that your mechanical equipment in which the product is installed satisfies the applicable requirements.

The installation and wiring methods of the motor and speed controller explained here represent the basic methods that are effective in helping your mechanical equipment conform to the EMC Directive.

The final level of conformance of your mechanical equipment to the EMC Directive will vary depending on such factors as the control system equipment used with the motor and speed controller, configuration of electrical parts, wiring, layout and hazard level. It therefore must be verified through conducting EMC measures on your mechanical equipment.

Effective measures must be taken against the EMI that the product may give to adjacent control-system equipment, as well as the EMS of the product itself, in order to prevent a serious functional impediment in the mechanical equipment. The use of the following installation and wiring methods will enable the product to be compliant with the EMC Directive.

■ Connecting mains filter for AC power supply line

- Install a mains filter, which the customer provides, in the power line in order to prevent the noise from propagating via the AC power line. For a mains filter, use the following model or equivalent product.

Manufacturer	Model
SOSHIN ELECTRIC CO.,LTD	NF2010A-UP
Schaffner EMC	FN2070-10-06

- Install the mains filter as close to the speed controller as possible. Use cable clamps and other means to secure the input cables and output cables of the mains filter firmly to the surface of the enclosure. Connect the ground terminal of the mains filter to the grounding point, using as thick and short a wire as possible.
- Do not place the input cable parallel with the output cable. Parallel placement will reduce mains filter effectiveness if the enclosure's internal noise is directly coupled to the AC power supply cable by means of stray capacitance.

■ Connecting motor cable

When extending the motor cable, use an accessory connection cable (sold separately). The wiring distance can be extended to a maximum of 10.5 m (34.4 ft.).

■ Surge arrester

A surge arrester is effective for reduction of the surge voltage of the lightning surge generated between the AC power line and earth or between AC power lines. Connect the following surge arrester.

Manufacturer	Model
SOSHIN ELECTRIC CO.,LTD	LT-C12G801WS

■ Wiring of the control cable

Use a cable of AWG24 (0.2 mm²) or thicker for the control cable, and keep the wiring distance as short as possible [2 m (6.6 ft.) or less].

■ Notes about installation and wiring

- Connect the motor, speed controller, and other peripheral control equipment directly to the grounding point so as to prevent a potential difference from developing between grounds.
- When relays or electromagnetic switches are used together with the product, use mains filters or CR circuits to suppress surges generated by them.
- Keep cables as short as possible without coiling and bundling extra lengths.
- Wire the power lines such as the AC power cable and motor cable away from the signal cables by providing a minimum clearance of 100 mm (3.94 in.) between them. If the power lines (AC power cable, motor cable) and signal cables have to cross, cross them at a right angle.
- Use an accessory connection cable (sold separately) when extending the wiring distance between the motor and speed controller. The EMC testing is conducted using the Oriental Motor connection cable.

■ Example of installation and wiring

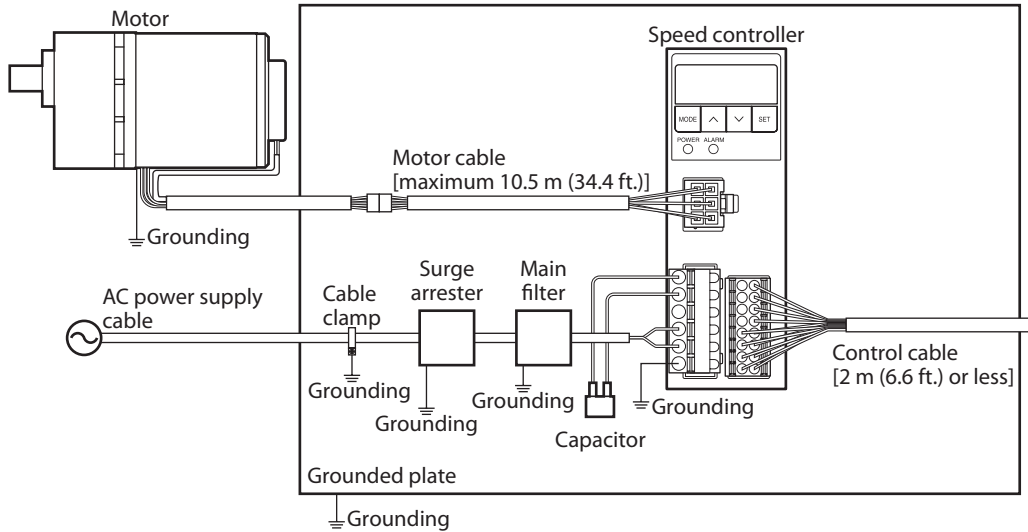

■ Precautions about static electricity

Static electricity may cause the speed controller to malfunction or suffer damaged.
Be sure to ground the motor and speed controller to prevent them from being damaged by static electricity.
Except when operating the operation panel on the speed controller, do not come near or touch the speed controller while the power is ON.

13 Specifications

13.1 Specifications

Check on the Oriental Motor Website for the product specifications.

13.2 General specifications

Operating environment	Ambient temperature	0 to +50 °C [+32 to +122 °F] (non-freezing)
	Ambient humidity	85% or less (non-condensing)
	Altitude	Up to 1000 m (3300 ft.) above sea level
	Surrounding atmosphere	No corrosive gas, dust, water or oil. Cannot be used in radioactive materials, magnetic field, vacuum or other special environments.
	Vibration	Not subject to continuous vibrations or excessive impact. In conformance with JIS C 60068-2-6 "Sine-wave vibration test method" Frequency range: 10 to 55 Hz Pulsating amplitude: 0.15 mm (0.006 in.) Sweep direction: 3 directions (X, Y, Z) Number of sweeps: 20 times
Storage environment Shipping environment	Ambient temperature	-25 to +70 °C [-13 to +158 °F] (non-freezing)
	Ambient humidity	85% or less (non-condensing)
	Altitude	Up to 3000 m (10000 ft.) above sea level
	Surrounding atmosphere	No corrosive gas, dust, water or oil. Cannot be used in radioactive materials, magnetic field, vacuum or other special environment.
Degree of protection		IP20

- Unauthorized reproduction or copying of all or part of this manual is prohibited.
If a new copy is required to replace an original manual that has been damaged or lost, please contact your nearest Oriental Motor branch or sales office.
- Oriental Motor shall not be liable whatsoever for any problems relating to industrial property rights arising from use of any information, circuit, equipment or device provided or referenced in this manual.
- Characteristics, specifications and dimensions are subject to change without notice.
- While we make every effort to offer accurate information in the manual, we welcome your input. Should you find unclear descriptions, errors or omissions, please contact the nearest office.
- **Orientalmotor** Orientalmotor is a registered trademark or trademark of Oriental Motor Co., Ltd., in Japan and other countries. Other product names and company names mentioned in this manual may be registered trademarks or trademarks of their respective companies and are hereby acknowledged. The third-party products mentioned in this manual are recommended products, and references to their names shall not be construed as any form of performance guarantee. Oriental Motor is not liable whatsoever for the performance of these third-party products.

© Copyright ORIENTAL MOTOR CO., LTD. 2018

Published in May 2018

- Please contact your nearest Oriental Motor office for further information.

ORIENTAL MOTOR U.S.A. CORP.
Technical Support Tel:(800)468-3982
8:30 A.M. to 5:00 P.M., P.S.T. (M-F)
7:30 A.M. to 5:00 P.M., C.S.T. (M-F)
www.orientalmotor.com

ORIENTAL MOTOR DO BRASIL LTDA.
Tel:+55-11-3266-6018
www.orientalmotor.com.br

ORIENTAL MOTOR (EUROPA) GmbH
Schiessstraße 44, 40549 Düsseldorf, Germany
Technical Support Tel:00 800/22 55 66 22
www.orientalmotor.de

ORIENTAL MOTOR (UK) LTD.
Tel:01256-347090
www.oriental-motor.co.uk

ORIENTAL MOTOR (FRANCE) SARL
Tel:01 47 86 97 50
www.orientalmotor.fr

ORIENTAL MOTOR ITALIA s.r.l.
Tel:02-93906346
www.orientalmotor.it

ORIENTAL MOTOR ASIA PACIFIC PTE. LTD.
Singapore
Tel:1800-8420280
www.orientalmotor.com.sg

ORIENTAL MOTOR (MALAYSIA) SDN. BHD.
Tel:1800-806161
www.orientalmotor.com.my

ORIENTAL MOTOR (THAILAND) CO., LTD.
Tel:1800-888-881
www.orientalmotor.co.th

ORIENTAL MOTOR (INDIA) PVT. LTD.
Tel:+91-80-41125586
www.orientalmotor.co.in

TAIWAN ORIENTAL MOTOR CO., LTD.
Tel:0800-060708
www.orientalmotor.com.tw

SHANGHAI ORIENTAL MOTOR CO., LTD.
Tel:400-820-6516
www.orientalmotor.com.cn

INA ORIENTAL MOTOR CO., LTD.
Korea
Tel:080-777-2042
www.inaom.co.kr

ORIENTAL MOTOR CO., LTD.
Hong Kong Branch
Tel:+852-2427-9800

ORIENTAL MOTOR CO., LTD.
4-8-1 Higashiueno, Taito-ku, Tokyo
110-8536 Japan
Tel:03-6744-0361
www.orientalmotor.co.jp