

AC Speed Controller

# **US2 Series**

---

## **OPERATING MANUAL**

Thank you for purchasing an Oriental Motor product.

This Operating Manual describes product handling procedures and safety precautions.

- Please read it thoroughly to ensure safe operation.
- Always keep the manual where it is readily available.



## Table of contents

1	Introduction .....	3	7	Convenient functions .....	18
1.1	Before using the product.....	3	7.1	Functions list .....	18
1.2	Related operating manuals.....	3	7.2	Panel displays and setting items.....	19
2	Safety precautions .....	4	7.3	Data locking for the set data.....	20
3	Preparation .....	6	7.4	Display after setting the speed reduction ratio .....	20
3.1	Checking the product.....	6	7.5	Soft start/soft stop function .....	21
3.2	How to identify the product model.....	6	7.6	Limiting the setting range of the rotation speed .....	22
3.3	Information about nameplate .....	6	7.7	Operating with external signals.....	22
3.4	Products possible to combine .....	7	8	Alarms.....	23
3.5	Names and functions of parts.....	10	9	Troubleshooting .....	24
4	Installation .....	11	10	Maintenance and inspection .....	25
4.1	Installation location.....	11	10.1	Inspection .....	25
4.2	Installing the speed controller.....	11	10.2	Warranty .....	25
5	Connection .....	13	10.3	Disposal.....	25
5.1	Connecting the power supply .....	13	11	Cable and peripheral equipment (sold separately).....	26
5.2	Connecting the motor and speed controller .....	14	12	Regulations and standards .....	27
5.3	Grounding.....	14	12.1	UL Standards, CSA Standards.....	27
5.4	Connecting input signals .....	15	12.2	CE Marking.....	27
6	Operation .....	16	12.3	RoHS Directive .....	27
6.1	Operation procedure .....	16	12.4	Conformity to the EMC.....	28
6.2	To adjust the motor rotation speed.....	17	13	Specifications.....	30
6.3	To switch the motor rotation direction .....	17	13.1	Specifications.....	30
			13.2	General specifications.....	30

# 1 Introduction

## 1.1 Before using the product

Only qualified personnel of electrical and mechanical engineering should work with the product.

Use the product correctly after thoroughly reading the section "Safety precautions." In addition, be sure to observe the contents described in warning, caution, and note in this manual.

The product described in this manual has been designed and manufactured to be incorporated in general industrial equipment. Do not use for any other purpose. Oriental Motor Co., Ltd. is not responsible for any damage caused through failure to observe this warning.

## 1.2 Related operating manuals

Operating manuals are not included with the product. Download from Oriental Motor Website Download Page or contact your nearest Oriental Motor sales office.

	Operating manual name
Speed controller	<b>US2 Series OPERATING MANUAL</b> (this document)
Motor	<b>SCM Motor OPERATING MANUAL</b>
	<b>SCM Motor Right Angle Shaft Hypoid Gear JH/JL Gearhead OPERATING MANUAL</b>



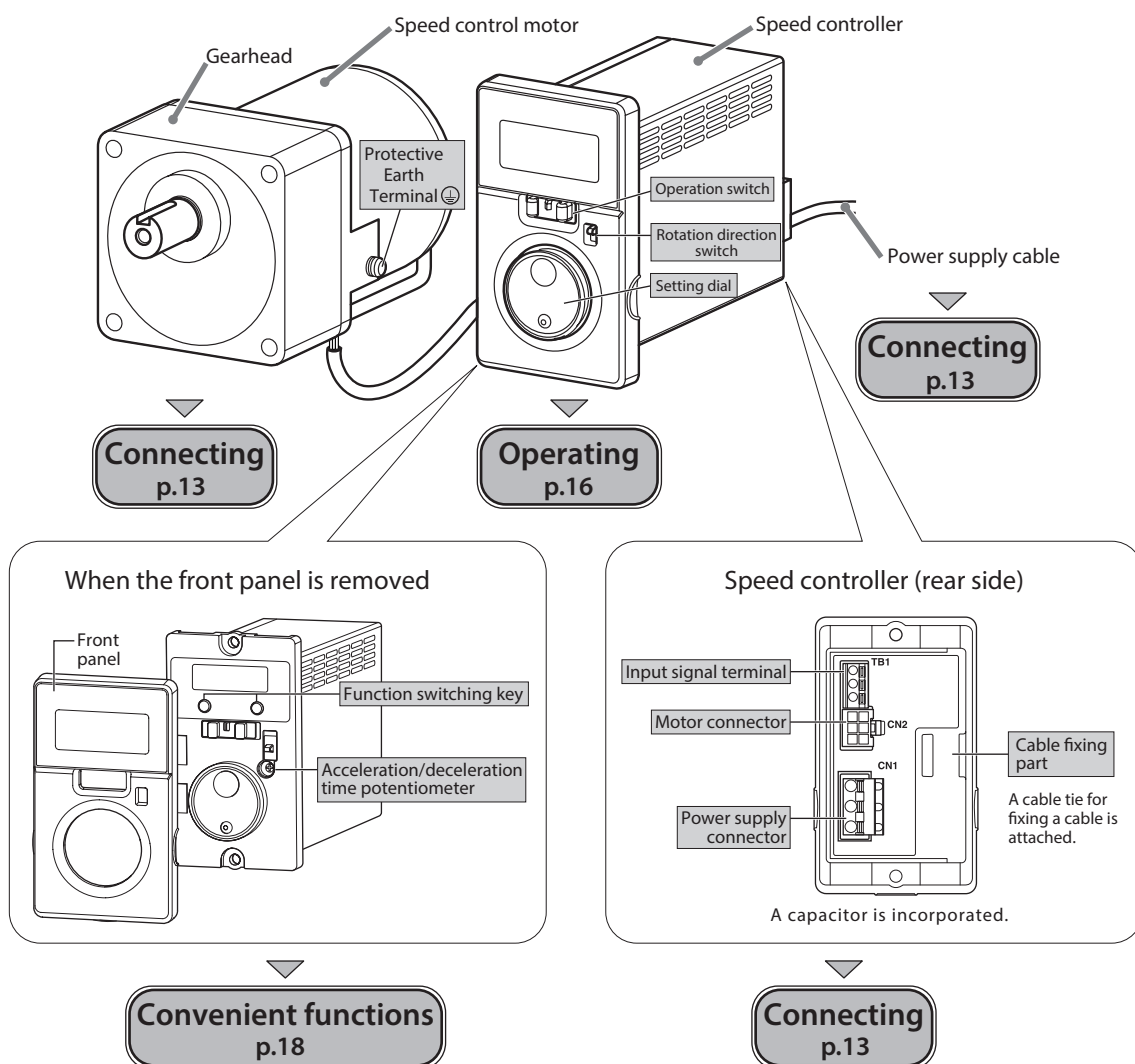

Search for an operating manual by the model name shown on the package label or nameplate.

## Names of parts









## 2 Safety precautions

The precautions described below are intended to prevent danger or injury to the user and other personnel through safe, correct use of the product. Use the product only after carefully reading and fully understanding these instructions.



 <b>WARNING</b>	Handling the product without observing the instructions that accompany a "WARNING" symbol may result in serious injury or death.
 <b>CAUTION</b>	Handling the product without observing the instructions that accompany a "CAUTION" symbol may result in injury or property damage.
	The items under this heading contain important handling instructions that the user should observe to ensure safe use of the product.
	The items under this heading contain related information and contents to gain a further understanding of the text in this manual.

### Explanation of graphic symbols

	Indicates "prohibited" actions that must not be performed.
	Indicates "compulsory" actions that must be performed.

 <b>WARNING</b>	
	<ul style="list-style-type: none"> <li>• Do not use the product in explosive or corrosive environments, in the presence of flammable gases, in places subjected to splashing water, or near combustibles. Doing so may result in fire, electric shock or injury.</li> <li>• Do not transport, install the product, perform connections or inspections when the power is on. Always turn the power off before carrying out these operations. Accidental contact may result in electric shock.</li> <li>• The terminals on the rear side of the speed controller marked with   symbol indicate the presence of high voltage. Do not touch the CN1 and CN2 while the power is supplied. Doing so may result in fire or electric shock.</li> <li>• Do not touch the connector of the speed controller immediately after the power is turned off (for a period of 1 minute). Accidental contact may result in electric shock.</li> <li>• Do not touch the speed controller when conducting insulation resistance measurement or dielectric strength test. Accidental contact may result in electric shock.</li> <li>• Do not disassemble or modify the speed controller. Doing so may result in electric shock or injury.</li> </ul>
	<ul style="list-style-type: none"> <li>• Only qualified and educated personnel should be allowed to perform installation, connection, operation and inspection/troubleshooting of the product. Handling by unqualified and uneducated personnel may result in fire, electric shock, injury or damage to equipment.</li> <li>• Install the speed controller in an enclosure. Failure to do so may result in electric shock or injury.</li> <li>• Observe the rated range for the AC power supply voltage to input to the speed controller. Failure to do so may result in fire or damage to equipment.</li> <li>• Securely connect and ground in accordance with the connection diagram. Failure to do so may result in fire or electric shock.</li> <li>• Connect an earth leakage breaker to the power line of the speed controller to protect the primary circuit. Failure to do so may result in fire.</li> <li>• Be sure to observe the specified cable sizes. Failure to do so may result in fire.</li> <li>• Use a motor and speed controller only in the specified combination. Failure to do so may result in fire, electric shock or damage to equipment.</li> <li>• Always turn off the power before performing maintenance or inspection. Failure to do so may result in electric shock.</li> </ul>

**CAUTION**

	<ul style="list-style-type: none"> <li>• Do not use the speed controller beyond its specifications. Doing so may result in electric shock, injury or damage to equipment.</li> <li>• Keep the area around the speed controller free of combustible materials. Failure to do so may result in fire or a skin burn(s).</li> <li>• Do not leave anything around the speed controller that would obstruct ventilation. Doing so may result in damage to equipment.</li> <li>• Do not wire the electromagnetic contactor or power relay between the motor and speed controller. To switch the rotation direction using the electromagnetic contactor may cause damage to equipment.</li> <li>• Do not use the product in elevating applications (vertical drives). Doing so may result in injury or damage to equipment.</li> </ul>
	<ul style="list-style-type: none"> <li>• If an alarm of the speed controller is generated, remove the cause before resetting the alarm. Failure to do so may result in injury or damage to equipment.</li> <li>• Securely install the speed controller to the mounting plate. Inappropriate installation may cause the speed controller to detach and fall, resulting in injury or equipment damage.</li> <li>• Provide an emergency-stop device or emergency-stop circuit external to the equipment so that the entire equipment will operate safely in the event of a system failure or malfunction. Failure to do so may result in injury.</li> <li>• Be sure to ground the speed controller to prevent it from being damaged by static electricity. Failure to do so may result in fire or damage to equipment.</li> <li>• If abnormal conditions occurred, stop the operation immediately and turn off the speed controller power. Failure to do so may result in fire, electric shock or injury.</li> <li>• Take safety measures in the event of a momentary voltage drop. This may cause the motor to stop, rotational torque, or rotation speed. Failure to do so may result in injury or damage to equipment.</li> </ul>

# 3 Preparation

This section explains the items you should check, as well as the name and function of each part.

## 3.1 Checking the product

Verify that the items listed below are included.

Report any missing or damaged items to the branch or sales office from which you purchased the product.

The model name purchased means the set of the speed controller and power supply cable. Verify the model name shown on the package label.

Refer to "3.4 Products possible to combine" on p.7 for combinations of the motor and speed controller.

Speed controller..... 1 unit

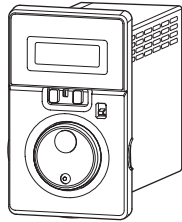

Power supply cable [2 m (6.6 ft.)].....1 piece  
Only for models supplied with the cable



Lead wire for frame ground connection (green, 1 piece)



A plug is attached with only the cables for the single-phase 100 VAC type.

The cables with a plug are for Japanese domestic market only.

Instructions and Precautions for Safe Use  
..... 1 copy

## 3.2 How to identify the product model

**US2D 25 - JA -CC**  
①      ②      ③      ④

①	Speed controller type	<b>US2D: US2</b> Series speed controller
②	Output power	<b>6:</b> 6 W <b>15:</b> 15 W <b>25:</b> 25 W <b>40:</b> 40 W <b>60:</b> 60 W <b>90:</b> 90 W
③	Power supply voltage	<b>JA:</b> Single-phase 100 VAC <b>JC:</b> Single-phase 200 VAC <b>UA:</b> Single-phase 110/115 VAC <b>EC:</b> Single-phase 220/230 VAC
④	Power supply cable	<b>-CC:</b> Included Blank: Not included

## 3.3 Information about nameplate

The figure shows an example.

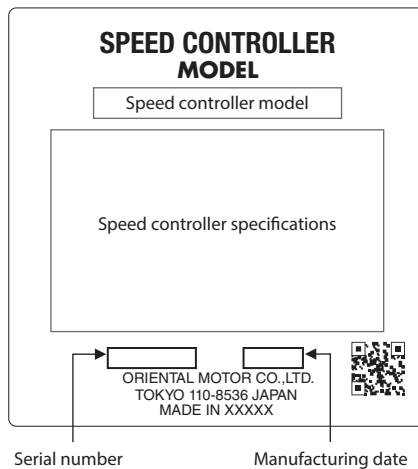

The position describing the information may vary depending on the product.

### 3.4 Products possible to combine

Be sure to match the output power and power supply voltage of the motor with those of the speed controller.

The box (□) in the model name indicates the number representing the gear ratio.

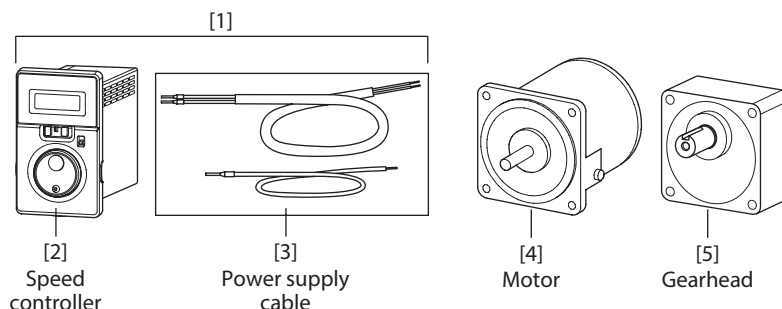

#### ■ Pinion shaft type/Parallel shaft gearhead GV gearhead

Output power	Power supply voltage	Speed controller			Applicable motor	
		Model	Component products model		Motor model	Gearhead model
		[1]	[2]	[3]	[4]	[5]
6 W	Single-phase 100 VAC	<b>US2D6-JA-CC</b>	US2D6-JA	CC02AC02P2	<b>SCM26GV-JA</b>	<b>2GV□B</b> <b>2GV□A</b>
	Single-phase 200 VAC	<b>US2D6-JC-CC</b>	US2D6-JC	CC02AC02N2	<b>SCM26GV-JC</b>	
	Single-phase 110/115 VAC	<b>US2D6-UA-CC</b>	US2D6-UA		<b>SCM26GV-UA</b>	
	Single-phase 220/230 VAC	<b>US2D6-EC-CC</b>	US2D6-EC	<b>SCM26GV-EC</b>		
15 W	Single-phase 100 VAC	<b>US2D15-JA-CC</b>	US2D15-JA	CC02AC02P2	<b>SCM315GV-JA</b>	<b>3GV□B</b> <b>3GV□A</b>
	Single-phase 200 VAC	<b>US2D15-JC-CC</b>	US2D15-JC	CC02AC02N2	<b>SCM315GV-JC</b>	
	Single-phase 110/115 VAC	<b>US2D15-UA-CC</b>	US2D15-UA		<b>SCM315GV-UA</b>	
	Single-phase 220/230 VAC	<b>US2D15-EC-CC</b>	US2D15-EC	<b>SCM315GV-EC</b>		
25 W	Single-phase 100 VAC	<b>US2D25-JA-CC</b>	US2D25-JA	CC02AC02P2	<b>SCM425GV-JA</b>	<b>4GV□B</b> <b>4GV□A</b>
	Single-phase 200 VAC	<b>US2D25-JC-CC</b>	US2D25-JC	CC02AC02N2	<b>SCM425GV-JC</b>	
	Single-phase 110/115 VAC	<b>US2D25-UA-CC</b>	US2D25-UA		<b>SCM425GV-UA</b>	
	Single-phase 220/230 VAC	<b>US2D25-EC-CC</b>	US2D25-EC	<b>SCM425GV-EC</b>		
40 W	Single-phase 100 VAC	<b>US2D40-JA-CC</b>	US2D40-JA	CC02AC02P2	<b>SCM540GV-JA</b>	<b>5GV□B</b> <b>5GV□A</b>
	Single-phase 200 VAC	<b>US2D40-JC-CC</b>	US2D40-JC	CC02AC02N2	<b>SCM540GV-JC</b>	
	Single-phase 110/115 VAC	<b>US2D40-UA-CC</b>	US2D40-UA		<b>SCM540GV-UA</b>	
	Single-phase 220/230 VAC	<b>US2D40-EC-CC</b>	US2D40-EC	<b>SCM540GV-EC</b>		
60 W	Single-phase 100 VAC	<b>US2D60-JA-CC</b>	US2D60-JA	CC02AC02P2	<b>SCM560GVH-JA</b>	<b>5GVH□B</b> <b>5GVH□A</b>
	Single-phase 200 VAC	<b>US2D60-JC-CC</b>	US2D60-JC	CC02AC02N2	<b>SCM560GVH-JC</b>	
	Single-phase 110/115 VAC	<b>US2D60-UA-CC</b>	US2D60-UA		<b>SCM560GVH-UA</b>	
	Single-phase 220/230 VAC	<b>US2D60-EC-CC</b>	US2D60-EC	<b>SCM560GVH-EC</b>		
90 W	Single-phase 100 VAC	<b>US2D90-JA-CC</b>	US2D90-JA	CC02AC02P2	<b>SCM590GVR-JA</b>	<b>5GVR□B</b> <b>5GVR□A</b>
	Single-phase 200 VAC	<b>US2D90-JC-CC</b>	US2D90-JC	CC02AC02N2	<b>SCM590GVR-JC</b>	
	Single-phase 110/115 VAC	<b>US2D90-UA-CC</b>	US2D90-UA		<b>SCM590GVR-UA</b>	
	Single-phase 220/230 VAC	<b>US2D90-EC-CC</b>	US2D90-EC	<b>SCM590GVR-EC</b>		

### ■ Round shaft type/Right-angle gearhead Hollow hypoid gear JH gearhead

Output power	Power supply voltage	Speed controller			Applicable motor	
		Model	Component products model		Motor model	Gearhead model
		[1]	[2]	[3]	[4]	[5]
25 W	Single-phase 100 VAC	<b>US2D25-JA-CC</b>	US2D25-JA	CC02AC02P2	<b>SCM425KJA</b>	<b>4H□B</b>
	Single-phase 200 VAC	<b>US2D25-JC-CC</b>	US2D25-JC	CC02AC02N2	<b>SCM425KJC</b>	
	Single-phase 110/115 VAC	<b>US2D25-UA-CC</b>	US2D25-UA		<b>SCM425KUA</b>	
	Single-phase 220/230 VAC	<b>US2D25-EC-CC</b>	US2D25-EC		<b>SCM425KEC</b>	
40 W	Single-phase 100 VAC	<b>US2D40-JA-CC</b>	US2D40-JA	CC02AC02P2	<b>SCM540KJA</b>	<b>5H□B</b>
	Single-phase 200 VAC	<b>US2D40-JC-CC</b>	US2D40-JC	CC02AC02N2	<b>SCM540KJC</b>	
	Single-phase 110/115 VAC	<b>US2D40-UA-CC</b>	US2D40-UA		<b>SCM540KUA</b>	
	Single-phase 220/230 VAC	<b>US2D40-EC-CC</b>	US2D40-EC		<b>SCM540KEC</b>	
90 W	Single-phase 100 VAC	<b>US2D90-JA-CC</b>	US2D90-JA	CC02AC02P2	<b>SCM590KJA</b>	<b>5H□B</b>
	Single-phase 200 VAC	<b>US2D90-JC-CC</b>	US2D90-JC	CC02AC02N2	<b>SCM590KJC</b>	
	Single-phase 110/115 VAC	<b>US2D90-UA-CC</b>	US2D90-UA		<b>SCM590KUA</b>	
	Single-phase 220/230 VAC	<b>US2D90-EC-CC</b>	US2D90-EC		<b>SCM590KEC</b>	

### ■ Round shaft type/Right-angle gearhead Solid hypoid gear JL Gearhead

Output power	Power supply voltage	Speed controller			Applicable motor	
		Model	Component products model		Motor model	Gearhead model
		[1]	[2]	[3]	[4]	[5]
25 W	Single-phase 100 VAC	<b>US2D25-JA-CC</b>	US2D25-JA	CC02AC02P2	<b>SCM425KJA</b>	<b>4L□B</b>
	Single-phase 200 VAC	<b>US2D25-JC-CC</b>	US2D25-JC	CC02AC02N2	<b>SCM425KJC</b>	
	Single-phase 110/115 VAC	<b>US2D25-UA-CC</b>	US2D25-UA		<b>SCM425KUA</b>	
	Single-phase 220/230 VAC	<b>US2D25-EC-CC</b>	US2D25-EC		<b>SCM425KEC</b>	
40 W	Single-phase 100 VAC	<b>US2D40-JA-CC</b>	US2D40-JA	CC02AC02P2	<b>SCM540KJA</b>	<b>5L□B</b>
	Single-phase 200 VAC	<b>US2D40-JC-CC</b>	US2D40-JC	CC02AC02N2	<b>SCM540KJC</b>	
	Single-phase 110/115 VAC	<b>US2D40-UA-CC</b>	US2D40-UA		<b>SCM540KUA</b>	
	Single-phase 220/230 VAC	<b>US2D40-EC-CC</b>	US2D40-EC		<b>SCM540KEC</b>	
90 W	Single-phase 100 VAC	<b>US2D90-JA-CC</b>	US2D90-JA	CC02AC02P2	<b>SCM590KJA</b>	<b>5L□B</b>
	Single-phase 200 VAC	<b>US2D90-JC-CC</b>	US2D90-JC	CC02AC02N2	<b>SCM590KJC</b>	
	Single-phase 110/115 VAC	<b>US2D90-UA-CC</b>	US2D90-UA		<b>SCM590KUA</b>	
	Single-phase 220/230 VAC	<b>US2D90-EC-CC</b>	US2D90-EC		<b>SCM590KEC</b>	

## ■ Round shaft type

Output power	Power supply voltage	Speed controller			Applicable motor
		Model	Component products model		Motor model
		[1]	[2]	[3]	[4]
6 W	Single-phase 100 VAC	<b>US2D6-JA-CC</b>	US2D6-JA	CC02AC02P2	<b>SCM26A-JA</b>
	Single-phase 200 VAC	<b>US2D6-JC-CC</b>	US2D6-JC		<b>SCM26A-JC</b>
	Single-phase 110/115 VAC	<b>US2D6-UA-CC</b>	US2D6-UA	CC02AC02N2	<b>SCM26A-UA</b>
	Single-phase 220/230 VAC	<b>US2D6-EC-CC</b>	US2D6-EC		<b>SCM26A-EC</b>
15 W	Single-phase 100 VAC	<b>US2D15-JA-CC</b>	US2D15-JA	CC02AC02P2	<b>SCM315A-JA</b>
	Single-phase 200 VAC	<b>US2D15-JC-CC</b>	US2D15-JC		<b>SCM315A-JC</b>
	Single-phase 110/115 VAC	<b>US2D15-UA-CC</b>	US2D15-UA	CC02AC02N2	<b>SCM315A-UA</b>
	Single-phase 220/230 VAC	<b>US2D15-EC-CC</b>	US2D15-EC		<b>SCM315A-EC</b>
25 W	Single-phase 100 VAC	<b>US2D25-JA-CC</b>	US2D25-JA	CC02AC02P2	<b>SCM425A-JA</b>
	Single-phase 200 VAC	<b>US2D25-JC-CC</b>	US2D25-JC		<b>SCM425A-JC</b>
	Single-phase 110/115 VAC	<b>US2D25-UA-CC</b>	US2D25-UA	CC02AC02N2	<b>SCM425A-UA</b>
	Single-phase 220/230 VAC	<b>US2D25-EC-CC</b>	US2D25-EC		<b>SCM425A-EC</b>
40 W	Single-phase 100 VAC	<b>US2D40-JA-CC</b>	US2D40-JA	CC02AC02P2	<b>SCM540A-JA</b>
	Single-phase 200 VAC	<b>US2D40-JC-CC</b>	US2D40-JC		<b>SCM540A-JC</b>
	Single-phase 110/115 VAC	<b>US2D40-UA-CC</b>	US2D40-UA	CC02AC02N2	<b>SCM540A-UA</b>
	Single-phase 220/230 VAC	<b>US2D40-EC-CC</b>	US2D40-EC		<b>SCM540A-EC</b>
60 W	Single-phase 100 VAC	<b>US2D60-JA-CC</b>	US2D60-JA	CC02AC02P2	<b>SCM560A-JA</b>
	Single-phase 200 VAC	<b>US2D60-JC-CC</b>	US2D60-JC		<b>SCM560A-JC</b>
	Single-phase 110/115 VAC	<b>US2D60-UA-CC</b>	US2D60-UA	CC02AC02N2	<b>SCM560A-UA</b>
	Single-phase 220/230 VAC	<b>US2D60-EC-CC</b>	US2D60-EC		<b>SCM560A-EC</b>
90 W	Single-phase 100 VAC	<b>US2D90-JA-CC</b>	US2D90-JA	CC02AC02P2	<b>SCM590A-JA</b>
	Single-phase 200 VAC	<b>US2D90-JC-CC</b>	US2D90-JC		<b>SCM590A-JC</b>
	Single-phase 110/115 VAC	<b>US2D90-UA-CC</b>	US2D90-UA	CC02AC02N2	<b>SCM590A-UA</b>
	Single-phase 220/230 VAC	<b>US2D90-EC-CC</b>	US2D90-EC		<b>SCM590A-EC</b>

### 3.5 Names and functions of parts

Front side When the front panel is attached

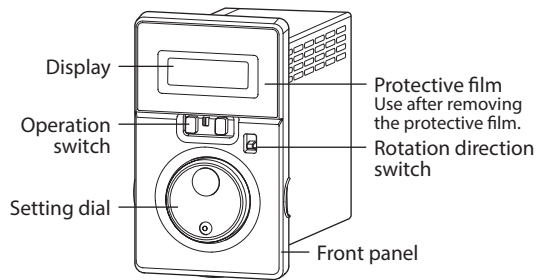

Display	This display shows the monitor item, alarms, etc.
Operation switch	Setting the operation switch to the "RUN" side causes the motor to rotate. Setting the operation switch to the "STAND-BY" side causes the motor to stop.
Setting dial	This setting dial is used to change the rotation speed and parameters. After changing, the new value is determined by pressing the setting dial.
Rotation direction switch	This switch is used to change the motor rotation direction.

Front side When the front panel is removed

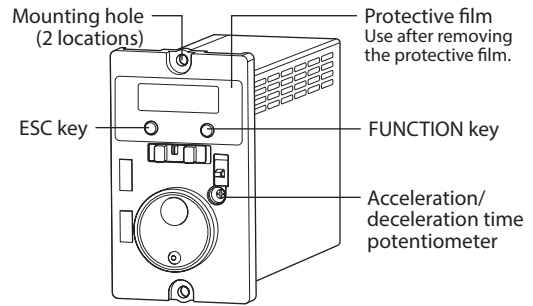

ESC key	This key is used to return to the previous level.
FUNCTION key	This key is used to switch the function.
Acceleration/ deceleration time potentiometer	This potentiometer is used to set the acceleration/deceleration time.
Mounting hole (2 places)	Installs the speed controller with screws (M4).

Rear side

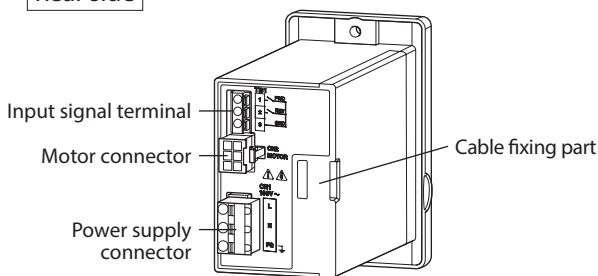

Motor connector	Connects the motor connector.
Power supply connector	Connects the AC power supply.

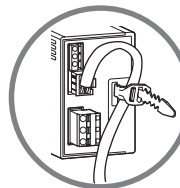

Fix as shown in the figure. This can prevent from giving stress to the connector terminal caused by movement of a cable.

Input signal terminal	Connects only when the motor is operated using external signals.
Cable fixing part	The motor cable can be fixed using a supplied cable-tie.

## 4 Installation

This chapter explains the installation location and installation methods.

### 4.1 Installation location

The speed controller described in this manual has been designed and manufactured to be incorporated in general industrial equipment.

Install it in a well-ventilated location that provides easy access for inspection. The location must also satisfy the following conditions:

- Indoors
- Operating ambient temperature: 0 to +50 °C [+32 to 122 °F] (non-freezing)
- Operating ambient humidity: 85% or less (non-condensing)
- Area that is free of explosive atmosphere or toxic gas (such as sulfuric gas) or liquid
- Area not stored combustible materials
- Area not exposed to direct sun
- Area free of excessive amount of dust, iron particles or the like
- Area not subject to splashing water (rain, water droplets), oil (oil droplets) or other liquids
- Area free of excessive salt
- Area not subject to continuous vibration or excessive shocks
- Area free of excessive electromagnetic noise (from welders, power machinery, etc.)
- Area free of radioactive materials, magnetic fields or vacuum
- Altitude Up to 1000 m (3300 ft.) above sea level

### 4.2 Installing the speed controller

The speed controller is designed so that heat is dissipated via air convection.

There must be a clearance of at least 25 mm (0.98 in.) and 50 mm (1.97 in.) clearances in the horizontal and vertical directions, respectively, between the speed controller and enclosure or other equipment within the enclosure.

#### ■ Installation direction

Install the speed controller so that the front panel side is turned in the front direction or upward.

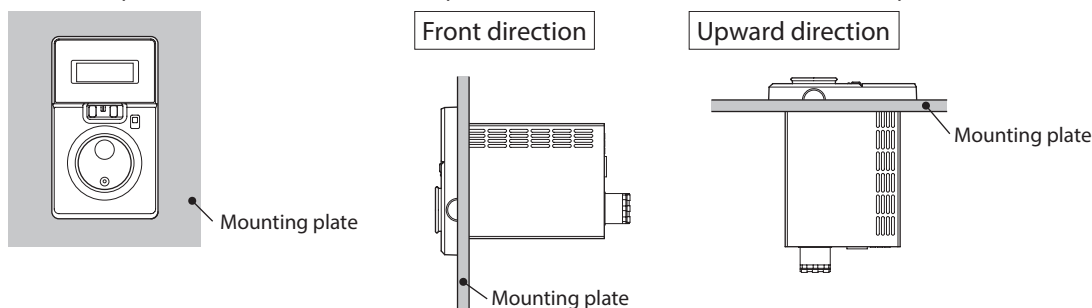

- Note**
- Do not install any equipment that generates a large amount of heat or noise near the speed controller.
  - If the ambient temperature of the speed controller exceeds the upper limit of the operating ambient temperature, revise the ventilation condition or forcibly cool the area around the speed controller using a fan in order to keep within the operating ambient temperature.

### ■ Installation method

Install the speed controller to a flat metal plate offering excellent vibration resistance.

Remove the front panel of the speed controller and secure the two mounting holes using screws, washers, and nuts (M4: not supplied). Tighten the screws until no gaps remain between the speed controller and mounting plate.

< Installation Example >

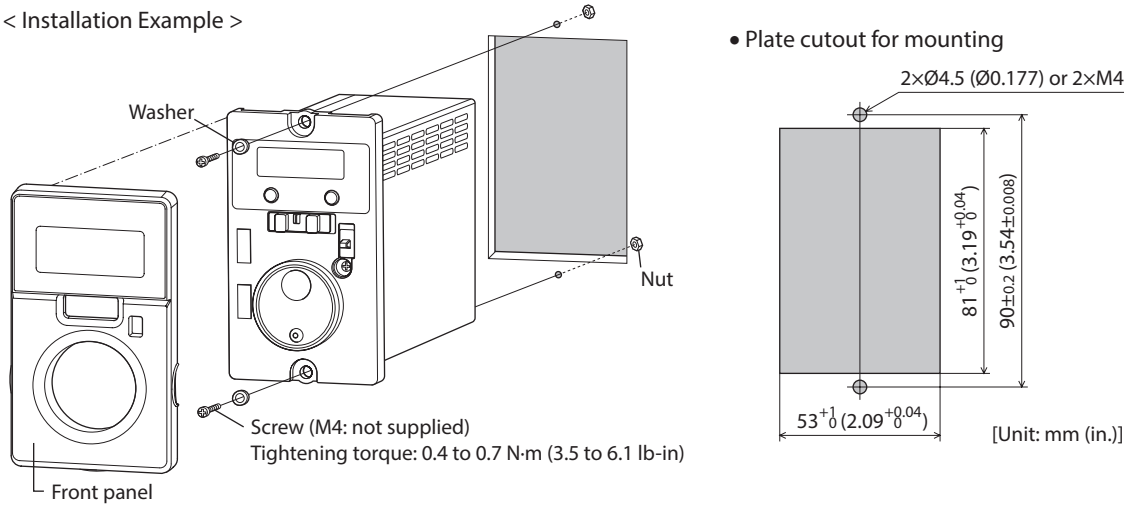

- Note**
- If a washer is used, use the washer which outer diameter is Ø9 mm (Ø0.35 in.) or less.
  - For screws to install the speed controller, keep 6 mm (0.24 in.) or less for the length of a screw head with a washer. The front panel cannot be installed if it is exceeded 6 mm (0.24 in.).

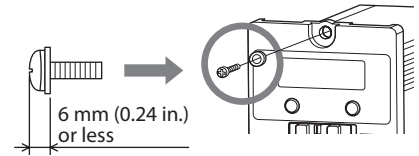

### Removing and installing the front panel

#### Installing

Install the front panel after placing it on the upper side of the front face of the speed controller.

#### Removing

Remove the front panel having the under side.

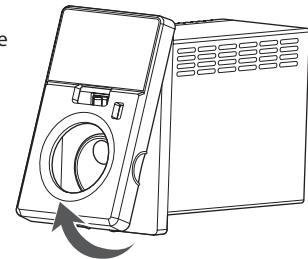

### ■ Dimension [mm (in.)]

Mass: 0.4 kg (0.88 lb.)

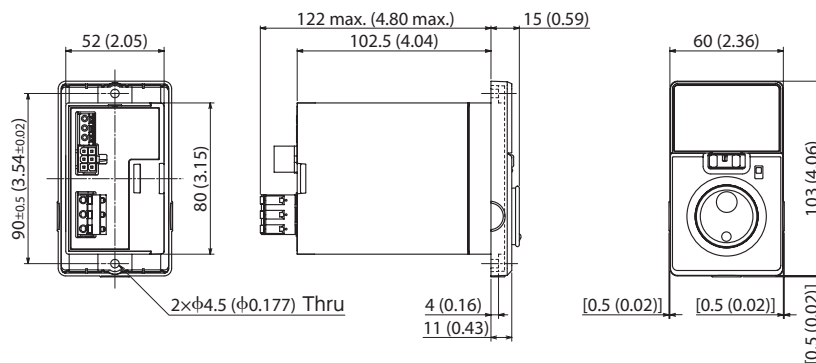

# 5 Connection

This chapter explains how to connect the speed controller and motor, input signals, and power supply, as well as the grounding method.

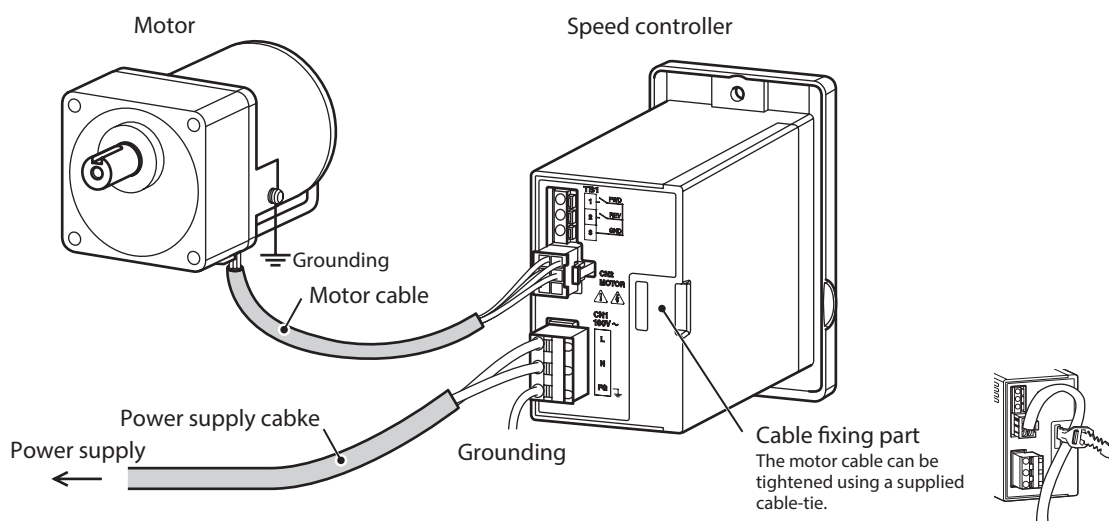

## 5.1 Connecting the power supply

Connect the AC power supply to the CN1 on the speed controller. When connecting, use a supplied power supply cable or provide a cable separately.

A lead wire for frame ground connection [green, 2 m (6.6 ft.)] is included in the supplied power supply cable. The supplied power supply cable does not have the polarity.

The power supply cables supplied with the single-phase 100 VAC type are attached a plug. They can be used in Japanese domestic market only.

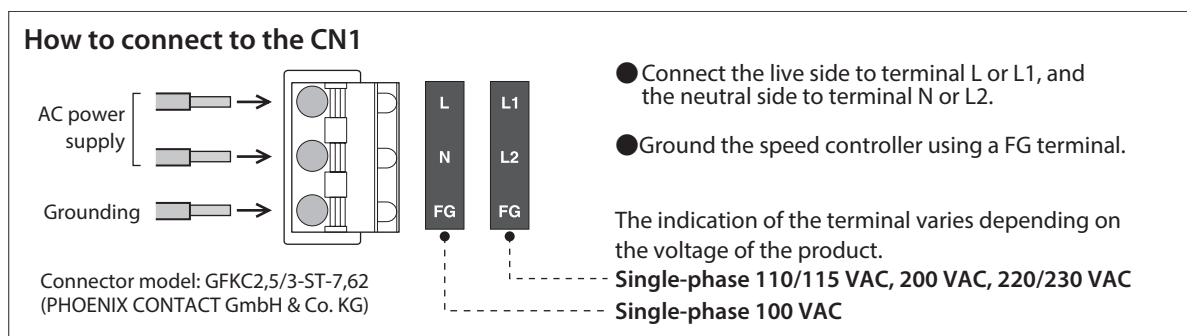

### Connecting the lead wire

Connect the lead wire of the supplied power supply cable to the connector. Insert the lead wire while pushing the button of the orange color with a screwdriver.

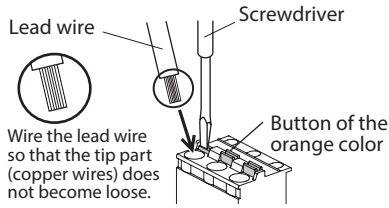

[When a cable other than the supplied power supply cable is used]

- Applicable lead wire: AWG18 to 14 (0.75 to 2.0 mm<sup>2</sup>)
- Strip the insulation cover of the lead wire

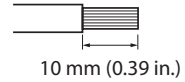

If crimp terminals are used, select the following terminals.

Manufacturer: PHOENIX CONTACT GmbH & Co. KG

Model: AI 0,75-10 [Conductor cross-sectional area: 0.65-0.82 mm<sup>2</sup> (AWG18)]

AI 1-10 [Conductor cross-sectional area: 0.82-1.2 mm<sup>2</sup> (AWG18)]

AI 1,5-10 [Conductor cross-sectional area: 1.25-1.8 mm<sup>2</sup> (AWG16)]

AI 2,5-10 [Conductor cross-sectional area: 2.0-3.0 mm<sup>2</sup> (AWG14)]

- Note**
- When inserting the lead wires into the connector, prevent the tip of the lead wires from spreading. Short-circuiting the lead wires may cause damage to the product.
  - Do not connect the output of the inverter to CN1. It may cause damage to the product.

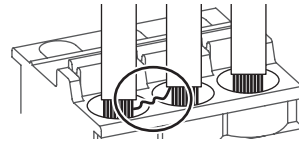

### ■ Connecting the earth leakage breaker

Connect an earth leakage breaker to the power line of the speed controller to protect the primary circuit. (⇒ Refer to p.27)

Recommended device: Mitsubishi Electric Corporation NV series

## 5.2 Connecting the motor and speed controller

Connect the motor cable connector to the CN2 on the speed controller.

Use a connection cable (sold separately) when extending the wiring distance between the motor and speed controller. The connection cable can be connected up to 3 pieces. Flexible connection cables(sold separately) are also available.

**Maximum extension distance between the motor and speed controller: 10.5 m (34.4 ft.)**

**[including 0.5 m (1.6 ft.) of the motor cable]**

- Note**
- Securely insert the motor connector into the speed controller, and fix the cable so as not to give stress to the connector terminal. Insecure connection may cause malfunction or damage to the motor or speed controller.
  - Use a motor and speed controller only in the specified combination. Unspecified combination may result in unusual temperature rise or damage to the product.

## 5.3 Grounding

Be sure to ground a motor using the Protective Earth Terminal (⊕) and the speed controller using the FG terminal.

- Note** Securely ground the motor and speed controller to prevent them from being damaged by static electricity. Static electricity may cause damage to the products if they are not grounded.

### ■ Motor

Ground close to the motor at a shortest distance using the Protective Earth Terminal (⊕) of the motor.

Applicable crimp terminal:

Round crimp terminal with insulation cover

Terminal screw size: M4

Tightening torque: 1.0 to 1.3 N·m (8.8 to 11.5 lb-in)

Applicable lead wire: AWG18 (0.75 mm<sup>2</sup>) or thicker

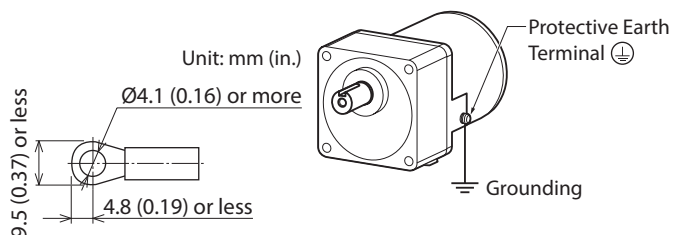

- Note** Do not use screws other than the Protective Earth Terminal screw attached on the product.

### ■ Speed controller

Ground the speed controller using the FG terminal of the CN1 (power supply connector).

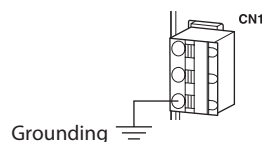

## 5.4 Connecting input signals

When the motor is operated and stopped externally, connect input signals to the TB1. The operation using the front panel is set at the time of shipment. Refer to p.22 for how to operate using input signals (external commands).

- Applicable lead wire: AWG24 to 16 (0.2 to 1.25 mm<sup>2</sup>)
- Lead wire strip length: 11 mm (0.43 in.)

### TB1 pin assignment

Indication	Signal name	Description
1	FWD	Forward input
2	REV	Reverse input
3	GND	Input signals common

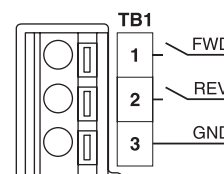

### ■ Connection example for input signals

All input signals of the speed controller are photocoupler inputs.

- This is a connection example for when the motor is operated using relays\* and switches

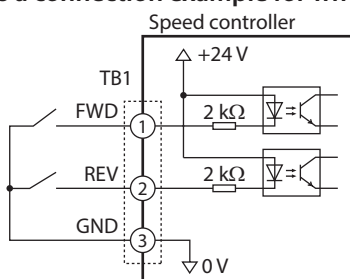

- \* For relays or transistors connecting to the input signals, use those of leakage current 1 mA or less.  
Recommended relay: Contact rated load DC30 V 15 mA

- This is a connection example for when the motor is operated using programmable controller

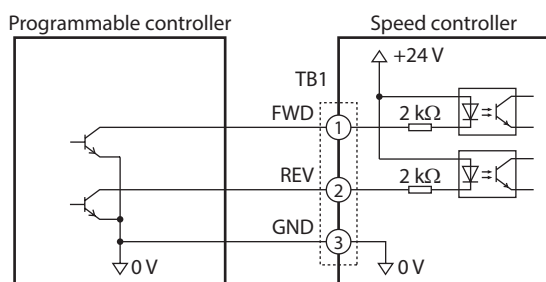

# 6 Operation

## 6.1 Operation procedure

After connecting, operate the product as follows.

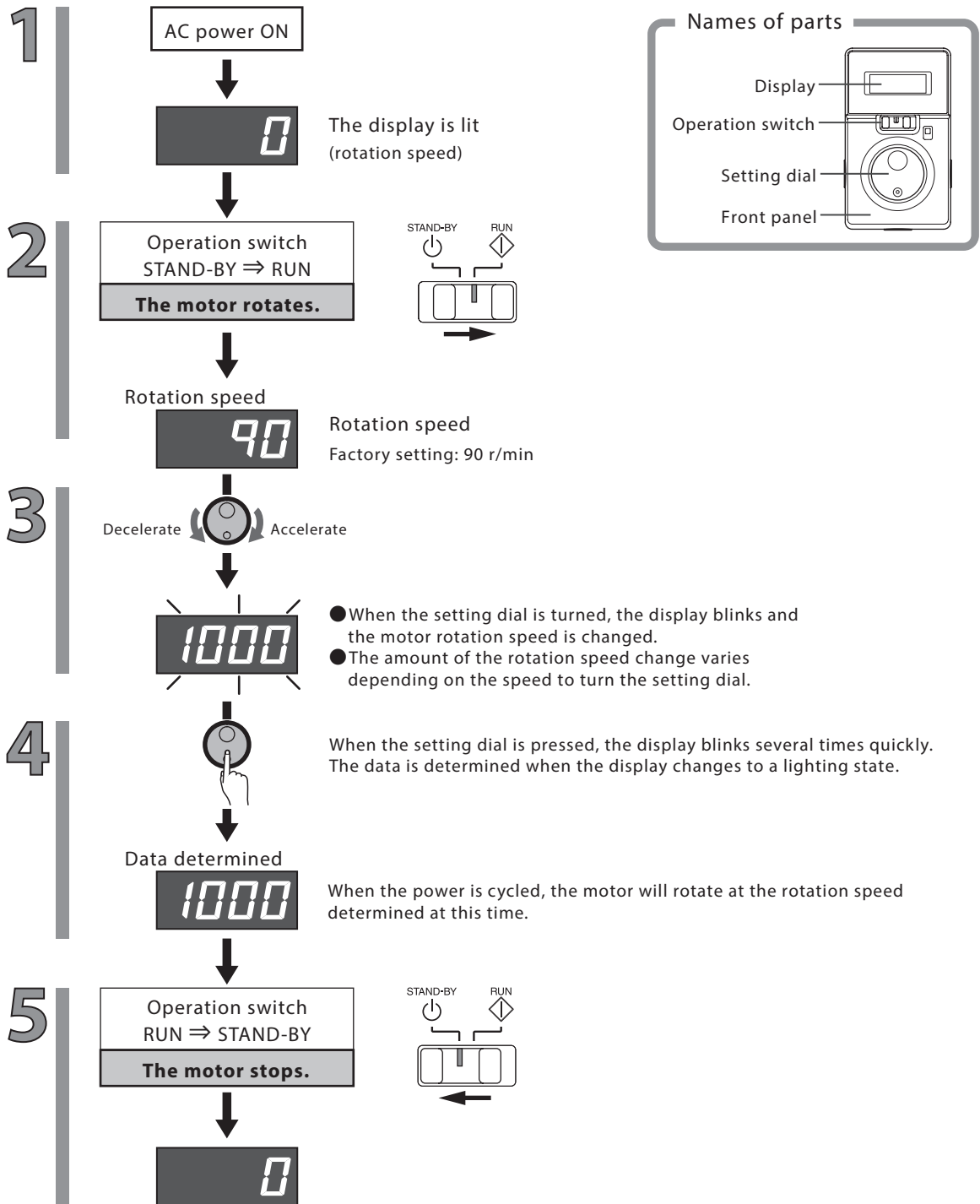

Refer to "Data locking for the set data" if the change of setting data is not allowed. p.20  
 Refer to "Alarms" if the alarm code such as **AL26** **AL30** or others is displayed. p.23  
 Refer to "Troubleshooting" if the motor does not rotate. p.24

## 6.2 To adjust the motor rotation speed

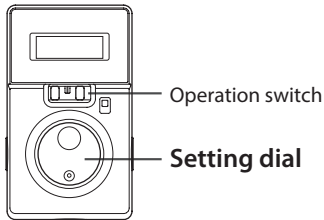

**Variable speed range**  
 50 Hz: 90 to 1400 r/min  
 60 Hz: 90 to 1600 r/min

Setting the operation switch to the "RUN" side causes the motor to rotate. Setting the operation switch to the "STAND-BY" side causes the motor to stop. The speed while the motor is rotating can be adjusted with the setting dial.

### Turning the setting dial slowly

When the setting dial is turned to the right, the rotation speed accelerates by 1 r/min increments. When the setting dial is turned to the left, the rotation speed decelerates by 1 r/min increments.

The display blinks at this time.

### Turning the setting dial quickly

The amount of the rotation speed change increases.

When the setting dial is pressed, the rotation speed is determined, and the display changes to a lighting state.

The actual rotation speed is indicated while the display is lit.

- The rotation speed can be set up to 1600 r/min. However, when the product is used at 50 Hz, the motor cannot be operated at the speed exceeding approximately 1420 r/min.
- The rotation speed can be set regardless of whether the motor rotates or stops.

## 6.3 To switch the motor rotation direction

The motor rotation direction can be changed with the rotation direction switch.

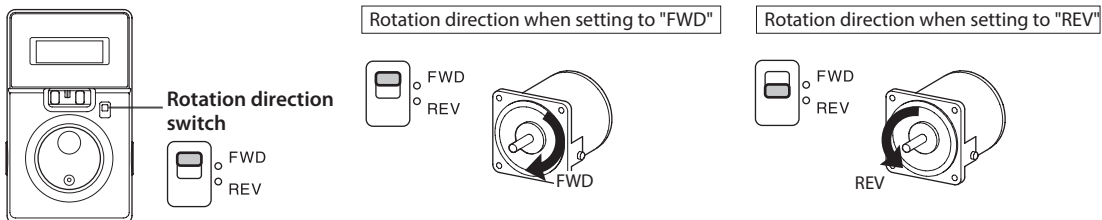

The rotation direction of the gearhead output shaft varies depending on the gear ratio of the gearhead. Check the operating manual of the motor. Change the rotation direction switch according to the gear ratio of the gearhead.

**Note** To change rotation direction of the motor, wait until the motor completely stops. If the rotation direction is switched while the motor is operating, it may not be changed, or it may be taken a long time to change.

# 7 Convenient functions

## 7.1 Functions list

Various setting can be performed when removing the front panel.

Display	<ul style="list-style-type: none"> <li>To display the rotation speed of the gearhead output shaft</li> <li>To display the conveyor transfer speed</li> </ul>	Parameter type	Display	Setting range	Factory setting
		Speed reduction ratio	<b>Gr-r</b>	1.00 to 9999	1.00
	<ul style="list-style-type: none"> <li>Sets the speed reduction ratio when the rotation speed of the gearhead output shaft is displayed.</li> <li>The conveyor transfer speed [m/rim] can be displayed if the conveyor speed reduction ratio calculated by the formula on p.20 is input.</li> <li>The number of digits to be displayed varies depending on the set speed reduction ratio. Refer to p.20 for the number of digits displayed.</li> </ul>				
To display the speed increased by an external mechanism	Parameter type	Display	Setting range	Factory setting	
	Speed increasing ratio	<b>SP-r</b>	1.00 to 5.00	1.00	
<ul style="list-style-type: none"> <li>When increasing the motor rotation speed using the external mechanism and others, the converted speed can be displayed.</li> <li>When setting the speed increasing ratio to other than 1.00, the speed increasing ratio will be effective.</li> </ul>					
To display the first digit of the rotation speed	Parameter type	Display	Setting range	Factory setting	
	Lowest digit display fixing	<b>dGOF</b>	<b>oFF</b> (Not fixed) <b>on</b> (Fixed)	<b>on</b>	
The lowest digit of the displayed rotation speed is fixed to "0" on the display. When displaying the value of the lowest digit, set this parameter to <b>oFF</b> (Not fixed).					
Operation	To start and stop the motor by ON-OFF control of the power supply	Parameter type	Display	Setting range	Factory setting
		Prevention of operation at power-on alarm	<b>oPRL</b>	<b>oFF</b> (Disable) <b>on</b> (Enable)	<b>on</b>
	Sets whether to enable or disable the "prevention of operation at power-on alarm." When starting or stopping the motor by ON-OFF control of the power supply, set this parameter to <b>oFF</b> (Disable).				
To start and stop the motor externally	Parameter type	Display	Setting range	Factory setting	
	External operation signal input	<b>ioEn</b>	<b>oFF</b> (Front panel) <b>rE</b> (External commands)	<b>oFF</b>	
The operation method can be selected between the front panel and external input signals. If <b>rE</b> (external commands) is selected, the input signals are enabled, and the operation switch and rotation direction switch are disabled. Refer to p.22 for details.					
To change the acceleration time and deceleration time of the motor	Parameter type	Display	Setting range	Factory setting	
	Acceleration/deceleration time	<b>tARtd</b>	<b>oFF</b> (Disable) <b>on</b> (Enable)	<b>oFF</b>	
Sets whether to enable or disable the acceleration/deceleration time potentiometer of the front panel. Refer to p.21 for details. If <b>on</b> (Enable) is selected, the acceleration time and deceleration time can be set using the acceleration/deceleration time potentiometer.					
Speed setting	To limit the setting range of the rotation speed	Parameter type	Display	Setting range	Factory setting
		Speed upper limit	<b>H<sub>1</sub></b>	90 to 1600	1600
	Speed lower limit	<b>Lo</b>	90		
The setting range of the rotation speed is set to 90 to 1600 r/min at the time of shipment. The upper and lower limits of this setting range can be limited. Refer to the next page for details.					
Lock	To lock the data	The data can be locked so that the set value does not change. Refer to p.20 for details.			
Initialization	To initialize the data	The data can be restored to the factory setting. Refer to the next page, and execute the "data initialization."			

## 7.2 Panel displays and setting items

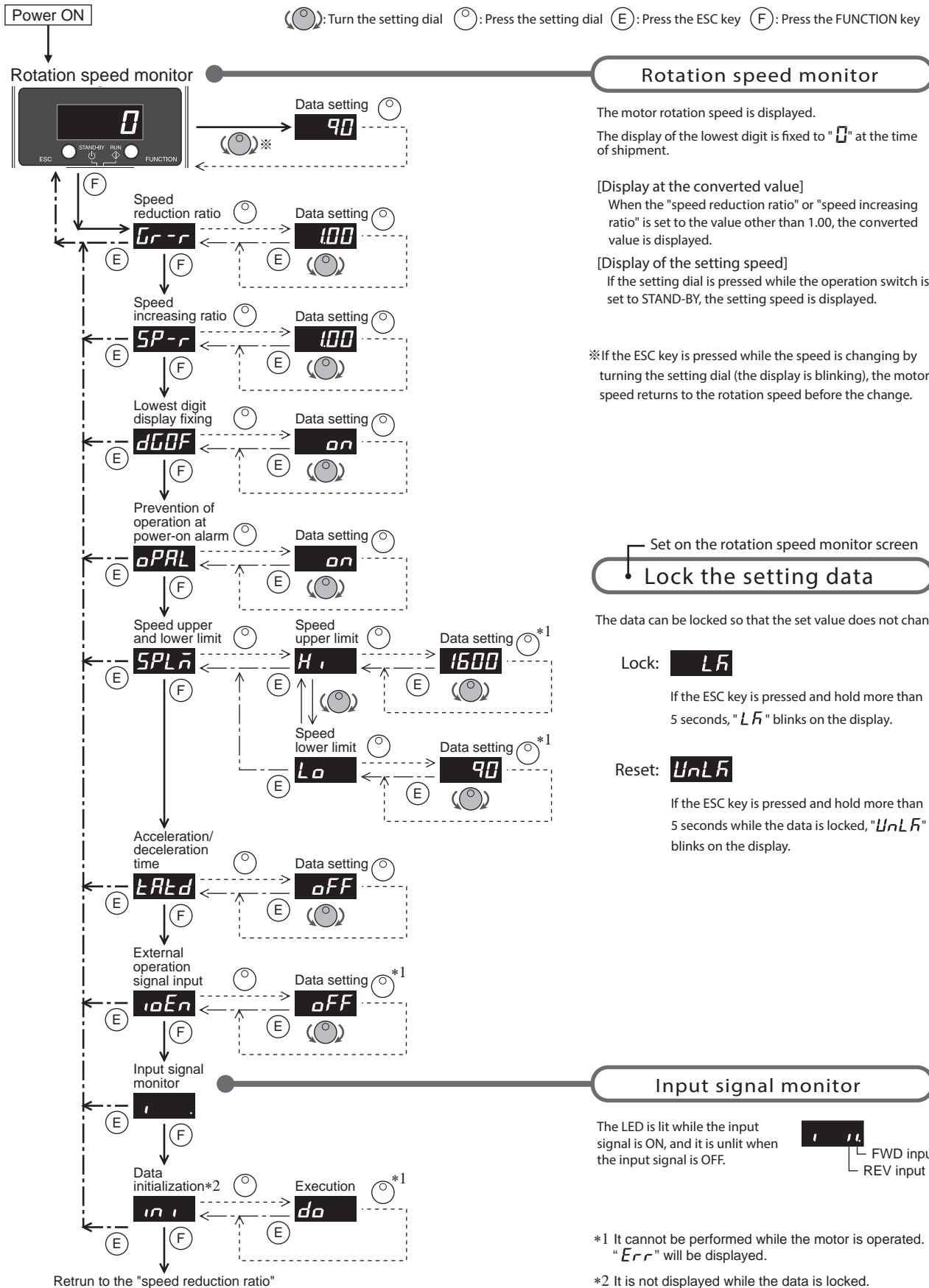

**Note** Do not turn off the power supply while the display is blinking after executing the data setting or initialization. Doing so may damage the data.

### 7.3 Data locking for the set data

The setting can be locked so that the set rotation speed and parameters do not change. The setting of data and parameters cannot be changed using the setting dial while the data is locked.

However, the setting data of each parameter can be checked even when the data is locked.

Remove the front panel when executing the data locking.

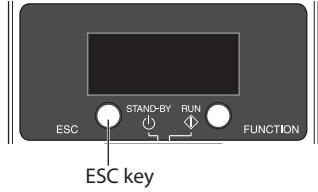

**Lock**

Rotation speed monitor 0

↓ Press and hold the ESC key (about 5 seconds)

Locking L F

**Reset**

Rotation speed monitor 0

↓ Press and hold the ESC key (about 5 seconds)

Reset locking U n L F

- **Display while the data is locked**

If you try to change the data while the data is locked, "L F" is displayed for about 1 second.

### 7.4 Display after setting the speed reduction ratio

- **Display of the rotation speed**

In the case of motors with the **JH** gearhead and **JL** gearhead, use the actual gear ratio about the gear ratio of gearhead. Check the operating manual of the motor for the actual gear ratio.

- **Display position of decimal point**

The position of the decimal point displayed on the rotation speed monitor varies depending on the set speed reduction ratio or speed increasing ratio as shown in the table below.

Setting value of the speed reduction ratio and speed increasing ratio	Display position of decimal point
1.00 to 9.99	<span style="border: 1px solid black; display: inline-block; width: 15px; height: 15px;"></span> <span style="border: 1px solid black; display: inline-block; width: 15px; height: 15px;"></span> <span style="border: 1px solid black; display: inline-block; width: 15px; height: 15px;"></span> <span style="border: 1px solid black; display: inline-block; width: 15px; height: 15px;"></span>
10.00 to 99.99	<span style="border: 1px solid black; display: inline-block; width: 15px; height: 15px;"></span> <span style="border: 1px solid black; display: inline-block; width: 15px; height: 15px;"></span> <span style="border: 1px solid black; display: inline-block; width: 15px; height: 15px;"></span> <span style="border: 1px solid black; display: inline-block; width: 15px; height: 15px;"></span> .
100.0 to 999.9	<span style="border: 1px solid black; display: inline-block; width: 15px; height: 15px;"></span> <span style="border: 1px solid black; display: inline-block; width: 15px; height: 15px;"></span> <span style="border: 1px solid black; display: inline-block; width: 15px; height: 15px;"></span> . <span style="border: 1px solid black; display: inline-block; width: 15px; height: 15px;"></span>
1000 or more	<span style="border: 1px solid black; display: inline-block; width: 15px; height: 15px;"></span> . <span style="border: 1px solid black; display: inline-block; width: 15px; height: 15px;"></span> <span style="border: 1px solid black; display: inline-block; width: 15px; height: 15px;"></span> <span style="border: 1px solid black; display: inline-block; width: 15px; height: 15px;"></span>

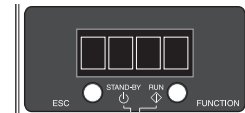

## ■ Display the conveyor transfer speed

To display the conveyor transfer speed, set the conveyor speed reduction ratio, which is calculated using the formula below, to the "speed reduction ratio" parameter.

$$\text{Conveyor speed reduction ratio} = \frac{1}{\text{Feed rate per motor revolution}} = \frac{\text{Gearhead gear ratio}}{\text{Pulley diameter [m]} \times \pi}$$

When the calculated conveyor speed reduction ratio is used, the conveyor transfer speed is converted as follows:

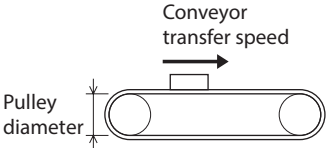
$$\text{Conveyor transfer speed [m/min]} = \frac{\text{Motor output shaft rotation speed [r/min]}}{\text{Conveyor speed reduction ratio}}$$

Example: The pulley diameter is 0.1 m and gear ratio of the gear head is 25

$$\text{Conveyor speed reduction ratio} = \frac{\text{Gearhead gear ratio}}{\text{Pulley diameter [m]} \times \pi} = \frac{25}{0.1 \text{ [m]} \times \pi} \cong 79.6$$

From the conversion formula, the conveyor speed reduction ratio is calculated as 79.6 in this example. When the "speed reduction ratio" parameter is set to "79.60" and the motor rotation speed is 1300 r/min, the conveyor transfer speed is converted as follows:

$$\text{Conveyor transfer speed [m/min]} = \frac{1300}{79.60} \cong 16.3$$

Accordingly, "16.3" is shown on the panel. The display varies depending on the setting of the "lowest digit display fixing" parameter. 16.0 is displayed at the time of shipment.

## 7.5 Soft start/soft stop function

An impact on a load is suppressed by soft start/stop operation of the motor, and the motor starts running smoothly. The acceleration time and deceleration time is fixed to about 1 second at the time of shipment.

When adjusting the acceleration time and deceleration time, change the setting of the "acceleration/deceleration time" parameter.

If this parameter is set to ON, the acceleration/deceleration time can be adjusted using the acceleration/deceleration time potentiometer.

Setting range of the acceleration/deceleration time potentiometer: 0.1 to 15.0 seconds

The actual acceleration time and deceleration time against the setting vary depending on the load inertia and frictional load.

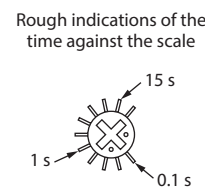
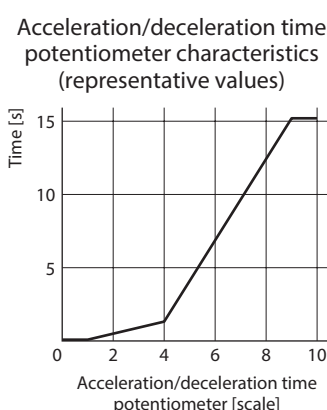
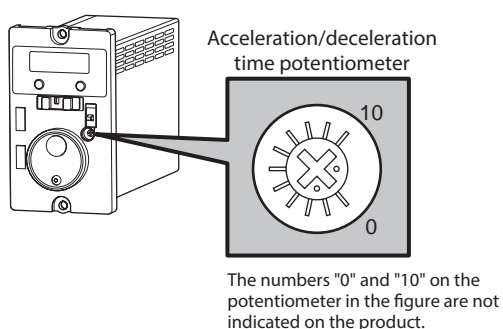

### ● Acceleration time

The acceleration time is set as the time needed for the motor to reach the 1000 r/min from the standstill state.

### ● Deceleration time

The deceleration time is set as the time needed for the motor to stop from the 1000 r/min.

If the deceleration time is set shorter than the time for coasting stop of the motor, the motor will not stop at the specified time.

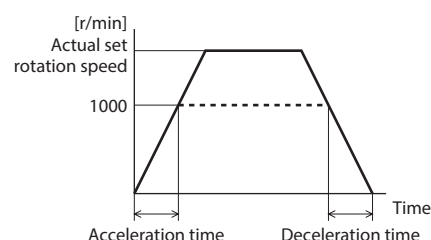

## 7.6 Limiting the setting range of the rotation speed

The setting range of the rotation speed using the setting dial can be limited by setting the upper limit and lower limit.

Speed setting range

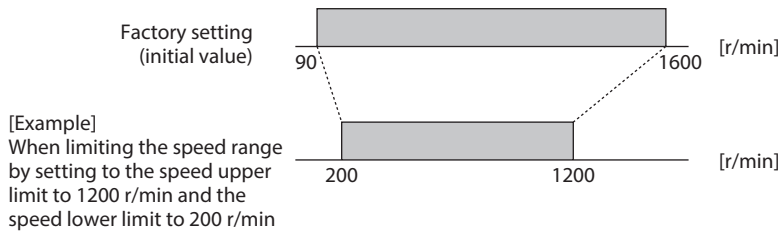

- **Speed upper limit**

The upper limit of the rotation speed can be set in the "speed upper limit" parameter. If the rotation speed exceeding the speed upper limit is already set, the rotation speed set in the "speed upper limit" parameter will be overwritten.

- **Speed lower limit**

The lower limit of the rotation speed can be set in the "speed lower limit" parameter. If the rotation speed below the speed lower limit is already set, the rotation speed set in the "speed lower limit" will be overwritten.

## 7.7 Operating with external signals

When the motor operation/standstill and rotation direction change are performed by ON/OFF-control of the input signals, disable the operation switch and rotation direction switch.

When the motor is operated externally, set the "external operation signal input" parameter to "rE".

If the operation switch or rotation direction switch is operated when the "external operation signal input" parameter is set to "rE", "rE" is displayed for about 1 second.

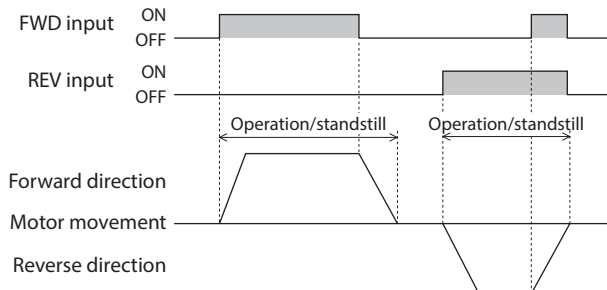

FWD input	REV input	Motor shaft action
ON	OFF	Rotates in the forward direction
OFF	ON	Rotates in the reverse direction
OFF	OFF	Standstill
ON	ON	

The motor rotation direction varies depending on the gear ratio of the gearhead or the setting of the rotation direction switch. Refer to p.17 for rotation direction of the motor.



To change rotation direction of the motor, wait until the motor completely stops.

If the rotation direction is switched while the motor is operating, it may not be changed, or it may be taken a long time to change.

## 8 Alarms

This product provides alarms (protective functions) to protect a motor and speed controller from temperature rise, poor connection, error in operation and others.

If the protective function is activated, the speed controller shuts off the output power to the motor, and the motor coasts to a stop.

At the same time, the alarm code blinks on the display of the front panel.

Although the display using the ESC key or FUNCTION key on the panel can be operated even when the alarm code is displayed, the display will return to the alarm indication if a non-operation state continues more than 5 seconds.

### ■ Alarm lists

Check the followings if the alarm code is displayed.

<p><b>AL26</b></p> <ul style="list-style-type: none"> <li>● Motor overheat</li> <li>● Motor poor connection</li> </ul>	<ul style="list-style-type: none"> <li>● The motor abnormally produced heat by some reason and a built-in overheat protection device (thermal protector) of the motor was activated (OPEN).</li> <li>● Disconnection or improper connection of the motor power line of the motor cable.</li> </ul>	<ul style="list-style-type: none"> <li>● Decrease the load.</li> <li>● Improve the operation condition such as the acceleration time or deceleration time.</li> <li>● Check the motor cable or connection of the connector part.</li> </ul>
<p><b>AL30</b></p> <ul style="list-style-type: none"> <li>● Motor lock</li> <li>● Motor poor connection</li> </ul>	<ul style="list-style-type: none"> <li>● The motor output shaft was locked for a minimum of 5 seconds.</li> <li>● Disconnection or poor connection of the rate generator lead wire of the motor cable.</li> </ul>	<ul style="list-style-type: none"> <li>● Decrease the load.</li> <li>● Check the motor cable or connection of the connector part.</li> </ul>
<p><b>AL41</b></p> <p>EEPROM error</p>	<ul style="list-style-type: none"> <li>● The power supply was turned off while the data setting or initialization is executed.</li> <li>● The stored data was damaged.</li> <li>● Data became no longer writable or readable.</li> </ul>	<ul style="list-style-type: none"> <li>● Initialize the data.</li> <li>● If the alarm cannot be cleared even when the power has been cycled, contact your nearest Oriental Motor sales office.</li> </ul>
<p><b>AL46</b></p> <p>Prevention of operation at power-on*</p>	<ul style="list-style-type: none"> <li>● The power supply was turned on while the operation switch was set to the RUN side.</li> <li>● The power supply was turned on while the FWD input or REV input was being ON.</li> </ul>	<ul style="list-style-type: none"> <li>● If the operation switch which is setting to the RUN side is set to the STAND-BY side, the alarm will be reset.</li> <li>● If the FWD input or REV input which has been turned ON is turned OFF, the alarm will be reset.</li> </ul>

\* If the "prevention of operation at power-on" parameter is set to disable, this alarm will not generate. (Initial setting: Enable)

#### ● "Motor overheat" alarm

Motors with an output power of 15 W to 90 W contain an automatic return type thermal protector in the motor windings. If the motor internal temperature exceeds the specified value, the thermal protector will be activated (OPEN) and the "motor overheat" alarm will be generated. Even if the thermal protector is closed to return automatically, the operation will not restart until the alarm is cleared.

Motors with an output power of 6 W are adopted impedance protection for overheat protection so that the temperature will not rise above a certain level.

### ■ Alarm reset

- Before resetting an alarm by the following methods, be sure to ensure safety with removing the cause of the alarm and setting the operation switch to the STAND-BY side. The alarm can be reset if the power is cycled.
- If the alarm is intended to reset while the operation switch is set to the RUN side, "Err" is displayed for about 1 second.

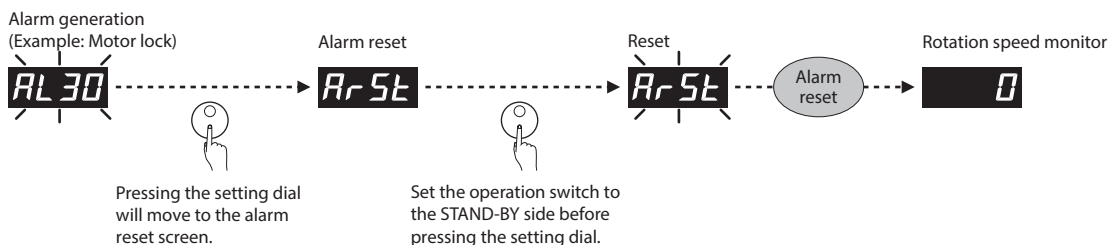

When the motor is operated using external signals, turn the FWD input or REV input OFF before resetting the alarm. "Err" is displayed if the alarm is reset while the signal is being ON.

- Note**
- If the product does not operate properly after the power is cycled, the internal circuit may be damaged. Contact your nearest Oriental Motor sales office.
  - Continuing the operation without removing the cause of the alarm may cause damage to equipment.

# 9 Troubleshooting

During motor operation, the motor or speed controller may fail to function properly due to an improper rotation speed setting or wiring.

When the motor cannot be operated correctly, refer to the contents provided in this chapter and take appropriate action. If the problem persists, contact your nearest Oriental Motor sales office.

**Note** Certain items must be checked with the power on. Perform inspections carefully not to touch the live part such as connection part of the motor and speed controller.

<p><b>Nothing is indicated on the display even if the power is supplied.</b></p>	<ul style="list-style-type: none"> <li>● The power supply is not connected properly.                             <ul style="list-style-type: none"> <li>▷ Check the connection of the AC power supply.</li> </ul> </li> </ul>
<p><b>The motor does not rotate.</b></p>	<ul style="list-style-type: none"> <li>● The motor is not connected properly.                             <ul style="list-style-type: none"> <li>▷ Check the connection of the motor cable.</li> </ul> </li> <li>● The operation switch on the speed controller is set to the "STAND-BY" side.                             <ul style="list-style-type: none"> <li>▷ Set the operation switch to the "RUN" side.</li> </ul> </li> <li>● When the motor is operated using external signals, the "external operation signal input" parameter is not set to "rE".                             <ul style="list-style-type: none"> <li>▷ Set the parameter to "rE".</li> </ul> </li> <li>● Both the FWD input and REV input are being OFF. Both the FWD input and REV input are being ON.                             <ul style="list-style-type: none"> <li>▷ Turn either of the FWD input or REV input ON.</li> </ul> </li> <li>● The voltage is being dropped.                             <ul style="list-style-type: none"> <li>▷ Apply the voltage within the specification range.</li> </ul> </li> <li>● The combination of the motor and speed controller is wrong.                             <ul style="list-style-type: none"> <li>▷ Use a motor and speed controller only in the specified combination. Check the tables on p.7 for the model name.</li> </ul> </li> </ul>
<p><b>The motor rotates in the direction opposite to the specified direction.</b></p>	<ul style="list-style-type: none"> <li>● The rotation direction switch is set to the opposite side.                             <ul style="list-style-type: none"> <li>▷ Check the rotation direction switch.</li> </ul> </li> <li>● The gearhead that rotates in the opposite direction to the motor rotation direction is used.                             <ul style="list-style-type: none"> <li>▷ Check the operating manual of the motor for the rotation direction of the gearhead output shaft.</li> </ul> </li> <li>● The FWD input and REV input are connected wrongly. Or they are not connected properly.                             <ul style="list-style-type: none"> <li>▷ Check the connection of the FWD input and REV input when the motor is operated using external signals.</li> </ul> </li> </ul>
<p><b>The speed cannot change. The motor does not rotate at the set speed.</b></p>	<ul style="list-style-type: none"> <li>● The setting range of the rotation speed is limited.                             <ul style="list-style-type: none"> <li>▷ Check the setting for the "speed upper limit" and "speed lower limit" parameters.</li> </ul> </li> </ul>
<p><b>The rotation speed cannot be increased.</b></p>	<ul style="list-style-type: none"> <li>● The speed upper limit is set.                             <ul style="list-style-type: none"> <li>▷ Increase the speed upper limit.</li> </ul> </li> </ul>
<p><b>The rotation speed cannot be decreased.</b></p>	<ul style="list-style-type: none"> <li>● The speed lower limit is set.                             <ul style="list-style-type: none"> <li>▷ Decrease the speed lower limit.</li> </ul> </li> </ul>
<p><b>The motor doesn't start instantaneously.</b></p>	<ul style="list-style-type: none"> <li>● The acceleration time is too long.                             <ul style="list-style-type: none"> <li>▷ Adjust the acceleration time.</li> </ul> </li> <li>● Load inertia is too large.                             <ul style="list-style-type: none"> <li>▷ Revise the load inertia.</li> </ul> </li> </ul>
<p><b>Data cannot be set.</b></p>	<ul style="list-style-type: none"> <li>● Data setting is locked.                             <ul style="list-style-type: none"> <li>▷ Release the lock for setting data.</li> </ul> </li> </ul>
<p><b>Motor operation is unstable. Motor vibration is too large.</b></p>	<ul style="list-style-type: none"> <li>● The product is affected by electrical noise.                             <ul style="list-style-type: none"> <li>▷ Refer to "12.4 Conformity to the EMC" on p.28 for the noise elimination measures.</li> </ul> </li> <li>● The combination of the motor and speed controller is wrong.                             <ul style="list-style-type: none"> <li>▷ Use a motor and speed controller only in the specified combination. Check the tables on p.7 for the model name.</li> </ul> </li> </ul>

# 10 Maintenance and inspection

---

## 10.1 Inspection

It is recommended that periodic inspections for the items listed below are conducted after each operation of the motor. If an abnormal condition is noted, discontinue any use and contact your nearest Oriental Motor sales office.



- Conduct the insulation resistance measurement or dielectric strength test separately on the motor and the speed controller. Conducting the insulation resistance measurement or dielectric strength test with the motor and speed controller connected may result in damage to the product.
- The speed controller uses semiconductor components. So be extremely careful when handling them. Static electricity may damage the speed controller.

### ■ Inspection item

- Check if any of the mounting screws for the motor and gearhead is loose.
- Check if the bearing part (ball bearings) of the motor generates unusual noises.
- Check if the bearing part (ball bearings) or gear meshing part of the gearhead generates unusual noises.
- Check if the output shaft of the motor and gearhead and a load shaft are out of alignment.
- Check if a damage or stress is applied on the cable, or the connection part between the motor and speed controller is loose.
- Check if the openings in the speed controller are clogged.
- Check if any of the speed controller connectors is loose.
- Check if the speed controller has appearance defects or unusual smells.

## 10.2 Warranty

Check on the Oriental Motor Website for the product warranty.

## 10.3 Disposal

Dispose the product correctly in accordance with laws and regulations, or instructions of local governments.

# 11 Cable and peripheral equipment (sold separately)

## ■ Connection cable

These cables are used to extend the wiring distance between the speed controller and motor. The connection cable can be connected up to 3 pieces.

Flexible connection cables are also available.

Maximum extension distance between the motor and speed controller: 10.5 m (34.4 ft.) [including 0.5 m (1.6 ft.) of the motor cable]

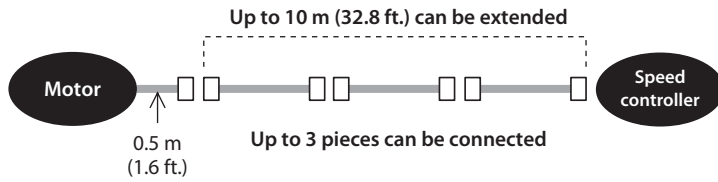

### • Connection cable

Length	Model
1 m (3.3 ft.)	<b>CC01SC</b>
2 m (6.6 ft.)	<b>CC02SC</b>
3 m (9.8 ft.)	<b>CC03SC</b>
5 m (16.4 ft.)	<b>CC05SC</b>
10 m (32.8 ft.)	<b>CC10SC</b>

### • Flexible connection cable

Length	Model
1 m (3.3 ft.)	<b>CC01SCR</b>
2 m (6.6 ft.)	<b>CC02SCR</b>
3 m (9.8 ft.)	<b>CC03SCR</b>
5 m (16.4 ft.)	<b>CC05SCR</b>
10 m (32.8 ft.)	<b>CC10SCR</b>

# 12 Regulations and standards

---

## 12.1 UL Standards, CSA Standards

This product is recognized by UL under the UL and CSA Standards.

## 12.2 CE Marking

This product is affixed with the marks under the following directives.

### ■ Low Voltage Directive

#### Installation conditions

Overvoltage category	II
Pollution degree	2
Degree of protection	IP20
Protection against electric shock	Class II equipment

If the overvoltage category III and pollution degree 3 are required for the equipment, install the motor and speed controller in an enclosure whose degree of protection is equivalent to IP54 or higher, and supply a rated voltage via the insulation transformer.

- This product cannot be used in IT power distribution systems.
- Isolate the motor cable, power supply cable from the input signal cable (TB1) by means of double insulation.

Since the speed controller is not equipped with a ground fault protection circuit, consider the following.

- Earth leakage breaker: Conforming to EN or IEC Standards  
Conditional short-circuit current rating I<sub>cc</sub>: 5 kA  
Rated sensitivity current: 30 mA or less

### ■ EMC Directive

Refer to "12.4 Conformity to the EMC" on p.28 for details about conformity.

## 12.3 RoHS Directive

This products do not contain the substances exceeding the restriction values.

## 12.4 Conformity to the EMC

Effective measures must be taken against the EMI that the motor and speed controller may give to adjacent controlsystem equipment, as well as the EMS of the motor and speed controller itself, in order to prevent a serious functional impediment in the machinery. The use of the following installation and wiring methods will enable the motor and speed controller to be compliant with the EMC.

Oriental Motor conducts EMC testing on its motors and speed controllers in accordance with "Example of installation and wiring" on p.29. The user is responsible for ensuring the machine's compliance with the EMC, based on the installation and wiring explained below.



### CAUTION

This equipment is not intended for use in residential environments nor for use on a low-voltage public network supplied in residential premises, and it may not provide adequate protection to radio reception interference in such environments.

#### ■ Connecting mains filter for AC power supply line

- Install a mains filter which the customer provides, in the power line in order to prevent the noise from propagating via the AC power line. For a mains filter, use the following model or equivalent product.

Manufacturer	Model
SOSHIN ELECTRIC CO.,LTD	NF2010A-UP, HF2010A-UPF
Schaffner EMC	FN2070-10-06

- Install the mains filter as close to the speed controller as possible. Use cable clamps and other means to secure the input cables and output cables firmly to the surface of the enclosure. Connect the ground terminal of the mains filter to the grounding point, using as thick and short a wire as possible.
- Do not place the input cable parallel with the output cable. Parallel placement will reduce mains filter effectiveness if the enclosure's internal noise is directly coupled to the AC power supply cable by means of stray capacitance.

#### ■ Connecting motor cable

When extending the motor cable, use the connection cable (sold separately). The wiring distance can be extended to a maximum of 10.5 m (34.4 ft.).

#### ■ Surge arrester

A surge arrester is effective for reduction of the surge voltage of the lightning surge generated between the AC power line and earth or between AC power lines. Connect the following surge arrester.

Manufacturer	Model
SOSHIN ELECTRIC CO.,LTD	LT-C12G801WS

#### ■ Wiring of the input signal cable

Use a cable of AWG24 to AWG16 (0.2 mm<sup>2</sup> to 1.25 mm<sup>2</sup>) or thicker for the input signal cable, and keep the wiring distance as short as possible [less than 2 m (6.6 ft.)].

#### ■ Notes about installation and wiring

- Connect the motor, speed controller, and other peripheral control equipment directly to the grounding point so as to prevent a potential difference from developing between grounds.
- When relays or electromagnetic switches are used together with the product, use mains filters or CR circuits to suppress surges generated by them.
- Keep cables as short as possible without coiling and bundling extra lengths.
- Wire the power lines such as the AC power cable and motor cable away from the input signal cable by providing a minimum clearance of 100 mm (3.94 in.) between them. If the power lines (AC power cable, motor cable) and the input signal cable have to cross, cross them at a right angle.
- Use a connection cable (sold separately) when extending the wiring distance between the motor and speed controller. The EMC measures are conducted using the Oriental Motor connection cable.

## ■ Example of installation and wiring

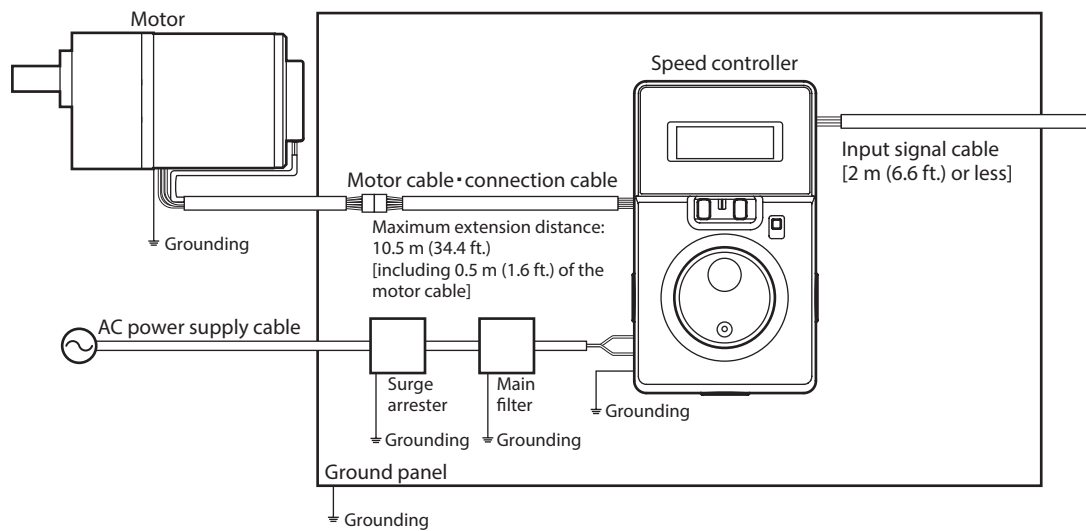

## ■ Precautions about static electricity

Static electricity may cause the speed controller to malfunction or suffer damaged.

Be sure to ground the motor and speed controller to prevent them from being damaged by static electricity.

Except when operating the operation panel on the speed controller, do not come near or touch the speed controller while the power is ON.

# 13 Specifications

## 13.1 Specifications

Check on the Oriental Motor Website for the product specifications.

## 13.2 General specifications

Operating environment	Ambient temperature	0 to +50 °C [+32 to +122 °F] (non-freezing)
	Ambient humidity	85% or less (non-condensing)
	Altitude	Up to 1000 m (3300 ft.) above sea level
	Surrounding atmosphere	No corrosive gas, dust, water or oil. Cannot be used in radioactive materials, magnetic field, vacuum or other special environments.
	Vibration	Not subject to continuous vibrations or excessive impact. In conformance with JIS C 60068-2-6 "Sine-wave vibration test method" Frequency range: 10 to 55 Hz Pulsating amplitude: 0.15 mm (0.006 in.) Sweep direction: 3 directions (X, Y, Z) Number of sweeps: 20 times
Storage environment	Ambient temperature	-25 to +70°C [-13 to +158°F] (non-freezing)
	Ambient humidity	85% or less (non-condensing)
Shipping environment	Altitude	Up to 3000 m (10000 ft.) above sea level
	Surrounding atmosphere	No corrosive gas, dust, water or oil. Cannot be used in radioactive materials, magnetic field, vacuum or other special environment.
Degree of protection		IP20



- Unauthorized reproduction or copying of all or part of this manual is prohibited.  
If a new copy is required to replace an original manual that has been damaged or lost, please contact your nearest Oriental Motor branch or sales office.
- Oriental Motor shall not be liable whatsoever for any problems relating to industrial property rights arising from use of any information, circuit, equipment or device provided or referenced in this manual.
- Characteristics, specifications and dimensions are subject to change without notice.
- While we make every effort to offer accurate information in the manual, we welcome your input. Should you find unclear descriptions, errors or omissions, please contact the nearest office.
- **Orientalmotor** is a registered trademark or trademark of Oriental Motor Co., Ltd., in Japan and other countries.  
Other product names and company names mentioned in this manual may be registered trademarks or trademarks of their respective companies and are hereby acknowledged. The third-party products mentioned in this manual are recommended products, and references to their names shall not be construed as any form of performance guarantee. Oriental Motor is not liable whatsoever for the performance of these third-party products.

© Copyright ORIENTAL MOTOR CO., LTD. 2018

Published in July 2025

- Please contact your nearest Oriental Motor office for further information.

ORIENTAL MOTOR U.S.A. CORP.  
Technical Support Tel:800-468-3982  
8:30am EST to 5:00pm PST (M-F)

ORIENTAL MOTOR (EUROPA) GmbH  
Schiessstraße 44, 40549 Düsseldorf, Germany  
Technical Support Tel:00 800/22 55 66 22

ORIENTAL MOTOR (UK) LTD.  
Blythe Valley Business Park,  
Central Blvd Blythe Valley Park,  
Solihull B90 8AG, United Kingdom  
Tel:+44-1926-671220

ORIENTAL MOTOR (FRANCE) SARL  
Tel:+33-1 47 86 97 50

ORIENTAL MOTOR ITALIA s.r.l.  
Tel:+39-02-93906347

ORIENTAL MOTOR ASIA PACIFIC PTE. LTD.  
Singapore  
Tel:1800-842-0280

ORIENTAL MOTOR (MALAYSIA) SDN. BHD.  
Tel:1800-806-161

ORIENTAL MOTOR (THAILAND) CO., LTD.  
Tel:1800-888-881

ORIENTAL MOTOR (INDIA) PVT. LTD.  
Tel:1800-120-1995 (For English)  
1800-121-4149 (For Hindi)

TAIWAN ORIENTAL MOTOR CO., LTD.  
Tel:0800-060708

SHANGHAI ORIENTAL MOTOR CO., LTD.  
Tel:400-820-6516

INA ORIENTAL MOTOR CO., LTD.  
Korea  
Tel:080-777-2042

ORIENTAL MOTOR CO., LTD.  
4-8-1 Higashiueno, Taito-ku, Tokyo  
110-8536 Japan  
Tel:+81-3-6744-0361  
[www.orientalmotor.co.jp/ja](http://www.orientalmotor.co.jp/ja)