



Brushless Motors

BLV Series

R Type

OPERATING MANUAL

Function Edition

Basic function

Operating method

I/O signals

Power removal function

Modbus RTU control
(RS-485 communication)

Address codes list

Alarms and Information

Extended function

Appendix

Thank you for purchasing an Oriental Motor product.

This Operating Manual describes product handling procedures and safety precautions.

- Please read it thoroughly to ensure safe operation.
- Always keep the manual where it is readily available.

1	Operating manuals	8
----------	--------------------------------	----------

1 Basic function

1	Unit setting.....	10
1-1	Factory setting	10
1-2	User-defined position unit setting.....	10
1-3	User-defined velocity unit setting	25
1-4	User-defined acceleration/deceleration unit.....	27
1-5	Coordinate direction.....	28
1-6	Unit setting of geared motor	30
2	Coordinates management	31
2-1	Coordinate home positions.....	31
2-2	WRAP Function	32
3	Stopping movement	34
3-1	Operation stop input	34
3-2	Hardware overtravel	35
3-3	Software overtravel	36
3-4	Escape from the limit sensor.....	36
3-5	Priority of stop action	37
4	Torque limiting function.....	39
5	ATL function	40
6	Driver status and motor excitation.....	42
6-1	Driver status (motor non-excitation status)	43
6-2	Driver status (motor excitation status).....	47

2 Operating method

1	Flow of settings necessary for operation	50
2	Operation overview.....	51
3	Operation types.....	52
3-1	Types of operation.....	52
3-2	Operation methods and operation types	55
3-3	Setting method of target position.....	60
3-4	Selecting the operation type.....	63
3-5	Operation type and position loop	64
3-6	Motion extension mode.....	66
3-7	Continuous operation (cyclic speed control).....	67
4	Direct data operation	68
4-1	Guidance	69
4-2	Command necessary for direct data operation	75
4-3	Trigger and lifetime	78
4-4	Data destination	81
4-5	Transfer of operation data	82
4-6	Operation example when operation data was overridden	83
4-7	Timing chart.....	85

5	Stored data operation	86
5-1	Types of stored data (SD) operation.....	86
5-2	Setting the data	87
5-3	Operation I/O event	91
5-4	Operation data number selection.....	92
5-5	Operating method and timing chart	94
5-6	Link method of operation data	96
5-7	Sequence function	106
6	FW/RV operation	112
6-1	Types of FW/RV operation	112
6-2	JOG operation	114
6-3	High-speed JOG operation.....	116
6-4	Inching operation	118
6-5	Continuous operation (position control)	120
6-6	Continuous operation (speed control).....	123
6-7	Continuous operation (push-motion)	126
7	I/O homing operation	129
7-1	3-sensor mode	133
7-2	2-sensor mode	136
7-3	One-way rotation mode	138
7-4	Push-motion mode	140
8	Extended function	142
8-1	Acceleration/deceleration setting method	142
8-2	Accept stored data override operation start by START input	143
8-3	Automatic S-ON for the FW/RV operation	145

3 I/O signals

1	Overview of I/O signals	148
1-1	Overview of input signals	148
1-2	Overview of output signals	148
1-3	Setting contents of input signals and output signals.....	149
2	Signals list.....	151
2-1	Input signals list.....	151
2-2	Output signals list	154
3	Signal type.....	160
3-1	Direct I/O	160
3-2	Remote I/O	161
4	Input signals.....	163
4-1	Excitation switching signals	163
4-2	Operation stop signals	166
4-3	Signals used for stored data operation	177
4-4	Signals used for FW/RV operation	179
4-5	Signal used for homing operation.....	179
4-6	External sensor input signals	180
4-7	Coordinate preset signals	181

4-8	Status releasing signals.....	182
4-9	Driver function change signals.....	183
4-10	Communication setting change signals.....	185
4-11	Latch input signals.....	186
4-12	User alarm input signal.....	186
5	Output signals	187
5-1	Driver status indication signals.....	187
5-2	Hardware status indication.....	188
5-3	Operation status indication.....	188
5-4	Operation ready indication	193
5-5	Direct data operation status indication	194
5-6	Stored data operation status indication.....	195
5-7	Function status indication	196
5-8	Power removal function signals	196
5-9	Motor position indication	197
5-10	Coordinate status indication.....	199
5-11	Latch information indication	200
5-12	User output signals.....	201
5-13	Response output.....	203
6	Using general signals	204
7	Timing chart.....	205

4 Power removal function

1	Overview of power removal function	208
1-1	Block diagram.....	208
2	Safety precautions for the power removal function	209
3	Connecting I/O signals for power removal function	210
3-1	Input signals.....	210
3-2	Output signal.....	211
4	How to use power removal function	212
4-1	Transition to power removal status.....	212
4-2	Return from power removal status.....	213
4-3	Failure detection of power removal function	214
5	Related functions	215
5-1	Input signal.....	215
5-2	Output signals.....	215
5-3	Alarms	216
5-4	Parameters.....	216

5 Modbus RTU control (RS-485 communication)

1	Modbus RTU specifications	218
1-1	Communications specifications.....	219
1-2	Communication timing.....	222
2	Message structure.....	224

2-1	Query	224
2-2	Response	226
3	Function code	228
3-1	Reading from a holding register(s) (03h)	228
3-2	Writing to a holding register (06h)	229
3-3	Diagnosis (08h)	230
3-4	Writing to multiple holding registers (10h)	230
3-5	Read/write of multiple holding registers (17h)	232
4	Flow of settings necessary for Modbus communication	234
5	Setting of RS-485 communication	235
5-1	Parameters updated when turning on the main power supply	235
5-2	Parameters updated immediately after overriding	236
6	Setting example of data in Modbus RTU mode	237
6-1	Remote I/O commands	237
7	Data setting method	240
7-1	Overview of setting methods	240
7-2	Direct reference	241
7-3	Indirect reference	242
8	Group send	256
9	RS-485 communication monitor	258
10	Timing chart	259
10-1	Communication start	259
10-2	Operation start	259
10-3	Operation stop, velocity change	259
10-4	General signal	260
10-5	Configuration	260
11	Detection of communication errors	261
11-1	Communication errors	261
11-2	Alarms related to RS-485 communication	261
11-3	Information related to RS-485 communication	262
12	Modbus RTU ID share mode	263
12-1	Overview of Modbus RTU ID share mode	263
12-2	Function code	264
12-3	Guidance	265
12-4	Flow of setting of ID share mode	270
12-5	Initial setting of ID share mode	271
12-6	Setting of data to be read or written	272
12-7	Read/write in ID share mode	275
12-8	Parameter list for Modbus RTU ID share mode	283

6 Address codes list

1	Timing for parameter to update	296
2	I/O commands	297
3	Group command	299

4	Protect release commands	300
5	Direct data operation commands	301
6	Modbus indirect reference commands	303
7	Modbus indirect reference commands (compatible)	311
8	General purpose registers	313
9	Maintenance commands	315
9-1	How to execute the maintenance commands.....	316
9-2	Reset communication.....	317
10	Monitor commands	318
11	Operation data R/W commands	338
11-1	Direct reference.....	338
11-2	Offset reference.....	343
12	Operation I/O event R/W commands	344
12-1	Setting method.....	344
12-2	Direct reference.....	344
12-3	Offset reference.....	346
13	Parameter R/W commands	348
13-1	Basic setting and operation setting.....	348
13-2	Unit setting, coordinate setting, mechanism setting, jog setting, homing setting.....	351
13-3	Communication setting (Modbus/CANopen).....	356
13-4	Communication setting (Modbus/CANopen) (compatible).....	365
13-5	Modbus ID share mode setting.....	366
13-6	Power removal setting, ETO setting, and alarm setting.....	368
13-7	I/O operation and function.....	370
13-8	Direct-IN function selection (DIN).....	379
13-9	Direct-OUT function selection (DOUT).....	380
13-10	Remote-I/O function selection (R-I/O).....	381
13-11	Adjustment and function.....	385
13-12	Information setting.....	388
13-13	USB and LED functions.....	397
13-14	User output function selection.....	401
13-15	Virtual input function selection (VIN).....	406
13-16	Data transfer.....	408
13-17	General purpose registers.....	415
13-18	Latch function.....	417
13-19	CANopen objects.....	418
14	I/O signals assignment list	424
14-1	Input signals.....	424
14-2	Output signals.....	425

7 Alarms and Information

1	Alarms	428
1-1	Alarm reset.....	428
1-2	Alarm history.....	428

1-3	Generation conditions of alarms	429
1-4	Alarms list.....	432
1-5	Timing chart.....	444
2	Information	448
2-1	Information output	448
2-2	Clearing information.....	450
2-3	Information history	450
2-4	Information list.....	451
2-5	Information status	461
2-6	LED indication for information.....	461

8 Extended function

1	Gain tuning.....	464
1-1	Setting of load inertia.....	464
1-2	Setting of motor response.....	464
2	Vibration suppression	467
2-1	Command filter.....	467
2-2	Resonance suppression	469
2-3	Damping control.....	470
2-4	Electronic damper.....	470
3	Virtual input	471
4	User output	472
5	Data transfer	474
6	Cumulative load	475
7	Load factor monitor.....	477
8	Actual velocity monitor	478
9	Latch function.....	479
10	Driver simulation mode.....	482
10-1	Use this function for the following	482
10-2	Monitor	482
10-3	Operation.....	482
10-4	Alarm	483
11	LED of driver.....	484
11-1	Changing the lighting color of LED.....	484
11-2	Changing the lighting conditions of LED.....	485
11-3	Changing the LED blinking condition when the main power supply is turned on	486

9 Appendix

1	Relation between operation types and operation data/parameters.....	488
----------	--	------------

1 Operating manuals

■ Related operating manuals

Operating manuals are not included with the product. Download them from Oriental Motor Website Download Page or contact your nearest Oriental Motor sales office.

Operating manual name	Manual number
BLV Series R Type OPERATING MANUAL Installation and Connection Edition	HP-5140
BLV Series R Type OPERATING MANUAL Function Edition (this document)	HP-5142
BLV Series R Type Driver CANopen Communication Profile	HP-5143

■ How to read this manual

● The setting unit may vary depending on the application such as support software.

Note the setting units when setting operation data and parameters.
This manual describes using the setting units shown below.

Position: [step]

Velocity: [r/min]

■ Motor rotation direction

The rotation direction of the motor shaft represents the direction when viewed from the motor shaft.

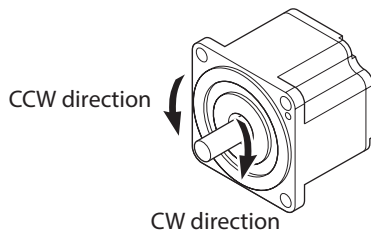

The relation between the setting value and the motor rotation direction are shown below.

Setting value	Notation	Motor rotation direction
Positive value	FWD	CW direction
Negative value	RVS	CCW direction

The motor rotation direction can be changed by changing the parameter.

1 Basic function

◆Table of contents

1	Unit setting.....	10
1-1	Factory setting	10
1-2	User-defined position unit setting	10
1-3	User-defined velocity unit setting	25
1-4	User-defined acceleration/deceleration unit.....	27
1-5	Coordinate direction.....	28
1-6	Unit setting of geared motor	30
2	Coordinates management	31
2-1	Coordinate home positions.....	31
2-2	WRAP Function	32
3	Stopping movement	34
3-1	Operation stop input	34
3-2	Hardware overtravel	35
3-3	Software overtravel.....	36
3-4	Escape from the limit sensor.....	36
3-5	Priority of stop action.....	37
4	Torque limiting function.....	39
5	ATL function	40
6	Driver status and motor excitation.....	42
6-1	Driver status (motor non-excitation status)	43
6-2	Driver status (motor excitation status).....	47

1 Unit setting

Units for the position, velocity, and acceleration/deceleration can be set.

Setting each unit can operate the product based on the position or the velocity on the motor shaft, the driving shaft of the gearbox, or the mechanism. Set a unit for the motor shaft, the driving shaft of the gearbox, or the mechanism according to the equipment used.

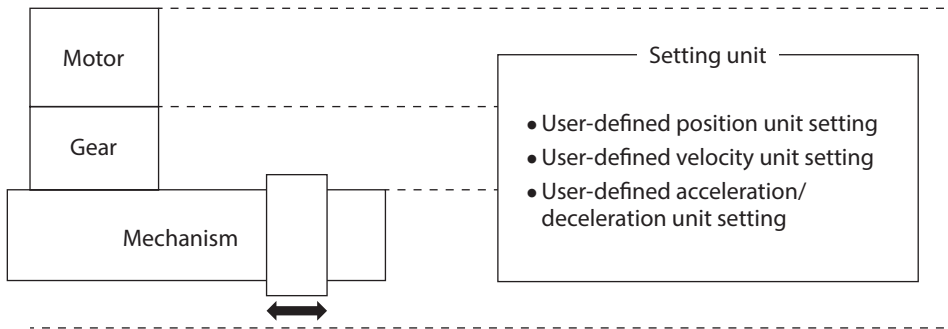

1-1 Factory setting

The motor shaft is set at the time of shipment. The unit setting for each item is as follows.

Item	Setting
User-defined position unit	[step]
User-defined velocity unit	[r/min]
User-defined acceleration/deceleration unit	[ms]
Control resolution	36,000 P/R [1 step = 0.01 deg. (motor shaft)]
Motor rotation direction	Positive value (FWD): CW direction Negative value (RVS): CCW direction
Drive shaft setting	Motor shaft

1-2 User-defined position unit setting

Setting the user-defined position unit can operate the product based on the position on the motor shaft, the driving shaft of the gearbox, or the mechanism. Set a unit for the motor shaft, the driving shaft of the gearbox, or the mechanism according to the equipment used.

The user-defined position unit having set is used as a unit of the travel amount or the actual position for positioning operation.

The setting method of the user-defined position unit varies depending on which position unit for the motor shaft, the driving shaft of the gearbox, or the mechanism is set. Select according to the equipment used.

- Drive shaft to be set and related parameters

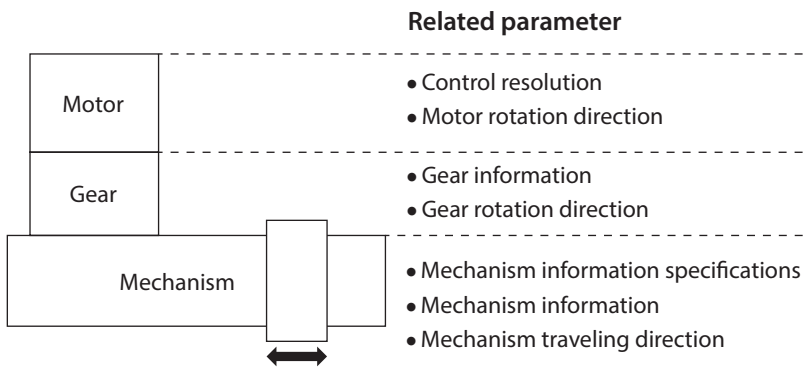

Name	Motor shaft	Driving shaft of gearbox	Mechanism
User-defined position unit setting	Possible	Possible	Possible
Control resolution (numerator)	Possible	Not possible	Not possible
Control resolution (denominator)	Possible	Not possible	Not possible
Motor rotation direction	Possible	Possible	Possible
Gear information (numerator)	Not possible	Possible	Possible
Gear information (denominator)	Not possible	Possible	Possible
Gear rotation direction	Not possible	Possible	Possible
Mechanism information specifications	Not possible	Not possible	Possible
Mechanism information (numerator)	Not possible	Not possible	Possible
Mechanism information (denominator)	Not possible	Not possible	Possible
Mechanism traveling direction	Not possible	Not possible	Possible

Specify with the "User-defined position unit setting" parameter to which drive shaft is used to set.

Drive shaft to be set	Setting value of "User-defined position unit setting" parameter
–	0: Encoder setting is prioritized (Use [Control resolution] if not a mechanical product) (initial value)
Motor shaft	1: Control resolution (step)
Mechanism	10: Use mechanism unit (×1)
	11: Use mechanism unit (×0.1)
	12: Use mechanism unit (×0.01)
	13: Use mechanism unit (×0.001)
Driving shaft of gearbox	23: 0.001 rev (driving shaft of gearbox)
	24: 0.0001 rev (driving shaft of gearbox)
	25: 0.00001 rev (driving shaft of gearbox)
	26: 0.000001 rev (driving shaft of gearbox)
	31: 0.1 deg (driving shaft of gearbox)
	32: 0.01 deg (driving shaft of gearbox)
	33: 0.001 deg (driving shaft of gearbox)
	34: 0.0001 deg (driving shaft of gearbox)

Select according to the equipment used or the minimum travel unit.

● Control resolution

The control resolution [P/R] represents a resolution per revolution of the motor shaft.

To control with the motor shaft, set with the "Control resolution (numerator)" and "Control resolution (denominator)" parameters.

When setting with the driving shaft of the gearbox or with the mechanism, the control resolution is automatically calculated inside the driver if the "User-defined position unit setting" parameter and the related parameters are set.

Note that the calculated value must fall within the setting range specified below.

Setting range of control resolution: 500 to 36,000 P/R (initial value: 36,000 P/R)

Note If a resolution out of the setting range is set, information of "Unit setting" will be generated. If the power supply is turned on again or Configuration is executed in a state where information of "Unit setting" is being generated, an alarm of "Unit setting error" will be generated.

memo The present control resolution can be checked with the "Unit information monitor" of the support software.

■ When setting with the motor shaft

Setting the following parameters can set the user-defined position unit based on the motor shaft.

- User-defined position unit setting
- Control resolution (numerator)
- Control resolution (denominator)
- Motor rotation direction

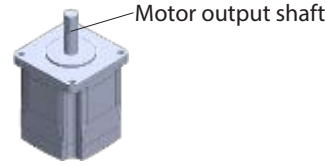

<Setting procedures>

1. Set "Control resolution (step)" to the "User-defined position unit setting" parameter.
2. Set the minimum travel amount for positioning operation with the "Control resolution (numerator)" and "Control resolution (denominator)" parameters.
(Initial value: Control resolution 36,000 P/R, which operates 0.01 degrees per step)
3. Sets the rotation direction of the motor shaft.

● Control resolution

If the "Control resolution (numerator)" and "Control resolution (denominator)" parameters are set, the control resolution per revolution of the motor shaft can be set.

Note that the calculated value must fall within the setting range specified below.

Setting range of control resolution: 500 to 36,000 P/R (initial value: 36,000 P/R)

$$\text{Control resolution (P/R)} = \frac{\text{Control resolution (numerator)}}{\text{Control resolution (denominator)}}$$



If a resolution out of the setting range is set, information of "Unit setting" will be generated. If the power supply is turned on again or Configuration is executed in a state where information of "Unit setting" is being generated, an alarm of "Unit setting error" will be generated.

● Rotation direction of drive shaft

Set the "Motor rotation direction" parameter according to your equipment.

Setting value of "Motor rotation direction" parameter	Rotation direction of motor shaft
0: Not invert (+ = CW)	Positive value (FWD): CW direction Negative value (RVS): CCW direction
1: Invert (+ = CCW)	Positive value (FWD): CCW direction Negative value (RVS): CW direction

● Setting example

<Conditions>

- To operate the motor shaft by 0.1 degrees per step.
- To rotate the motor in the CCW direction when a positive value is set.

<Settings of parameters>

Parameter	Setting value
User-defined position unit setting	1: Control resolution (step)
Control resolution (numerator)	3600
Control resolution (denominator)	1
Motor rotation direction	1: Invert

<Value to be executed>

Item	Setting
User-defined position unit	[step]
Control resolution	3600 P/R (1 step = 0.1 deg.)
Rotation direction of motor shaft	Positive value (FWD): CCW direction Negative value (RVS): CW direction

■ When setting with the driving shaft of the gearbox

Setting the following parameters can set the user-defined position unit based on the driving shaft of the gearbox.

- User-defined position unit setting
- Motor rotation direction
- Gear information (numerator)
- Gear information (denominator)
- Gear rotation direction

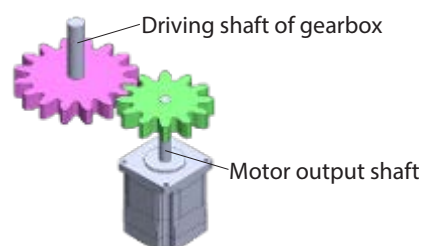

In the case of a geared motor, information of the gearhead is written to the motor (encoder) in advance. For details, refer to "1-6 Unit setting of geared motor" on p.30.

<Setting procedures>

1. Set the "User-defined position unit setting" parameter.
2. Set the gear ratio of equipment with the "Gear information (numerator)" and "Gear information (denominator)" parameters.
3. Set the rotation direction of the driving shaft of the gearbox based on that of the motor shaft.

● Gear ratio

The gear ratio can be set using the "Gear information (numerator)" and "Gear information (denominator)" parameters.

$$\text{Gear ratio} = \frac{\text{Gear information (numerator)}}{\text{Gear information (denominator)}}$$

The control resolution is automatically set inside the driver based on the "User-defined position unit setting" parameter and the gear ratio.

The calculation of the control resolution varies depending on the setting value of the "User-defined position unit setting" parameter.

When the user-defined position unit setting: "*** rev (driving shaft of gearbox)" is set

Drive shaft to be set	Setting value of "User-defined position unit setting" parameter
Driving shaft of gearbox	23: 0.001 rev (driving shaft of gearbox)
	24: 0.0001 rev (driving shaft of gearbox)
	25: 0.00001 rev (driving shaft of gearbox)
	26: 0.000001 rev (driving shaft of gearbox)

$$\text{Control resolution (P/R)} = \frac{1}{\text{User-defined position unit (driving shaft of gearbox)}} \times \frac{1}{\text{Gear ratio}}$$

When the user-defined position unit setting: "*** deg (driving shaft of gearbox)" is set

Drive shaft to be set	Setting value of "User-defined position unit setting" parameter
Driving shaft of gearbox	31: 0.1 deg (driving shaft of gearbox)
	32: 0.01 deg (driving shaft of gearbox)
	33: 0.001 deg (driving shaft of gearbox)
	34: 0.0001 deg (driving shaft of gearbox)

$$\text{Control resolution (P/R)} = \frac{360}{\text{User-defined position unit (driving shaft of gearbox)}} \times \frac{1}{\text{Gear ratio}}$$

Note that the calculated value must fall within the setting range specified below.

Setting range of control resolution: 500 to 36,000 P/R (initial value: 36,000 P/R)



If a resolution out of the setting range is set, information of "Unit setting" will be generated.
If the power supply is turned on again or Configuration is executed in a state where information of "Unit setting" is being generated, an alarm of "Unit setting error" will be generated.

● Rotation direction of drive shaft

Set the "Motor rotation direction" and "Gear rotation direction" parameters according to your equipment.

Setting value of "Motor rotation direction" parameter	Setting value of "Gear rotation direction" parameter	Rotation direction of motor shaft
0: Not invert (+ = CW)	0: Not invert	Positive value (FWD): CW direction Negative value (RVS): CCW direction
	1: Invert	Positive value (FWD): CCW direction Negative value (RVS): CW direction
1: Invert (+ = CCW)	0: Not invert	Positive value (FWD): CCW direction Negative value (RVS): CW direction
	1: Invert	Positive value (FWD): CW direction Negative value (RVS): CCW direction

● Setting example

<Conditions>

- To set the driving shaft of the gearbox by 0.0001 revolutions.
- To use a gear of the gear ratio 10.
- The driving shaft of the gearbox and the motor shaft rotate in the same direction.
- To rotate the driving shaft of the gearbox in the CCW direction when a positive value is set.

<Settings of parameters>

Parameter	Setting value
User-defined position unit setting	24: 0.0001 rev (driving shaft of gearbox)
Gear information (numerator)	10
Gear information (denominator)	1
Gear rotation direction	1: Invert
Motor rotation direction	0: Not invert

<Control resolution calculation>

$$\text{Control resolution (P/R)} = \frac{1}{0.0001 \text{ rev}} \times \frac{1}{10} = 1000$$

<Value to be executed>

Item	Setting
User-defined position unit	[0.0001 rev] (driving shaft of gearbox)
Control resolution	1000 P/R (1 step = 0.001 rev (motor shaft))
Rotation direction of driving shaft of gearbox	Positive value (FWD): CCW direction Negative value (RVS): CW direction

■ When setting with the mechanism

Setting the following parameters can set the user-defined position unit based on the mechanism.

- User-defined position unit setting
- Motor rotation direction
- Gear information (numerator)
- Gear information (denominator)
- Gear rotation direction
- Mechanism information specifications
- Mechanism information (numerator)
- Mechanism information (denominator)
- Mechanism traveling direction

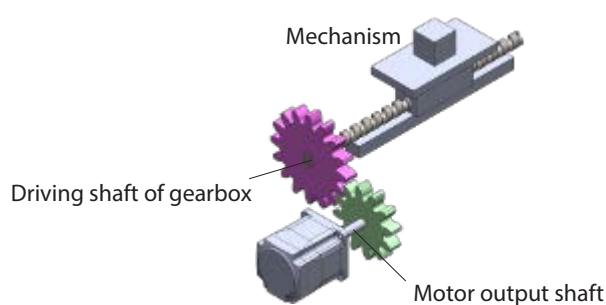

When setting with the mechanism, the user-defined position unit based on the mechanism can be set using the "User-defined position unit setting" and "Mechanism information specifications" parameters.

"Mechanism information specifications" parameter	"User-defined position unit setting" parameter	User-defined position unit (mechanism)
No unit	Use mechanism unit (×1)	[1 × no unit]
	Use mechanism unit (×0.1)	[0.1 × no unit]
	Use mechanism unit (×0.01)	[0.01 × no unit]
	Use mechanism unit (×0.001)	[0.001 × no unit]
Linear motion [mm], setting: travel amount [mm/rev]	Use mechanism unit (×1)	[1 × mm]
	Use mechanism unit (×0.1)	[0.1 × mm]
	Use mechanism unit (×0.01)	[0.01 × mm]
	Use mechanism unit (×0.001)	[0.001 × mm]
Wheel [mm], setting: diameter [mm]	Use mechanism unit (×1)	[1 × mm]
	Use mechanism unit (×0.1)	[0.1 × mm]
	Use mechanism unit (×0.01)	[0.01 × mm]
	Use mechanism unit (×0.001)	[0.001 × mm]
Rotation [rev], setting: mechanism reduction ratio	Use mechanism unit (×1)	[1 × rev]
	Use mechanism unit (×0.1)	[0.1 × rev]
	Use mechanism unit (×0.01)	[0.01 × rev]
	Use mechanism unit (×0.001)	[0.001 × rev]
Rotation [deg], setting: mechanism reduction ratio	Use mechanism unit (×1)	[1 × deg]
	Use mechanism unit (×0.1)	[0.1 × deg]
	Use mechanism unit (×0.01)	[0.01 × deg]
	Use mechanism unit (×0.001)	[0.001 × deg]

<Setting procedures>

1. Set the "User-defined position unit setting" and "Mechanism information specifications" parameters according to equipment and the minimum travel unit.
2. Set the gear ratio of equipment with the "Gear information (numerator)" and "Gear information (denominator)" parameters.
3. Set the rotation direction of the driving shaft of the gearbox based on that of the motor shaft.
4. Sets the traveling direction of the mechanism based on the rotation direction of the driving shaft of the gearbox.

- **Mechanism traveling direction**

Set the "Motor rotation direction," "Gear rotation direction," and "Mechanism traveling direction" parameters according to the equipment used.

"Motor rotation direction" parameter setting value	"Gear rotation direction" parameter setting value	"Mechanism traveling direction" parameter setting value	Rotation direction of motor shaft
0: Not invert (+ = CW)	0: Not invert	0: Not invert	Positive value (FWD): CW direction Negative value (RVS): CCW direction
		1: Invert	Positive value (FWD): CCW direction Negative value (RVS): CW direction
	1: Invert	0: Not invert	Positive value (FWD): CCW direction Negative value (RVS): CW direction
		1: Invert	Positive value (FWD): CW direction Negative value (RVS): CCW direction
1: Invert (+ = CCW)	0: Not invert	0: Not invert	Positive value (FWD): CCW direction Negative value (RVS): CW direction
		1: Invert	Positive value (FWD): CW direction Negative value (RVS): CCW direction
	1: Invert	0: Not invert	Positive value (FWD): CW direction Negative value (RVS): CCW direction
		1: Invert	Positive value (FWD): CCW direction Negative value (RVS): CW direction

- **When "No unit" is selected in Mechanism information specifications**

Select when a mechanism is installed on the driving shaft of the gearbox. Use when the user-defined position unit is set as desired other than [mm].

Illustration example

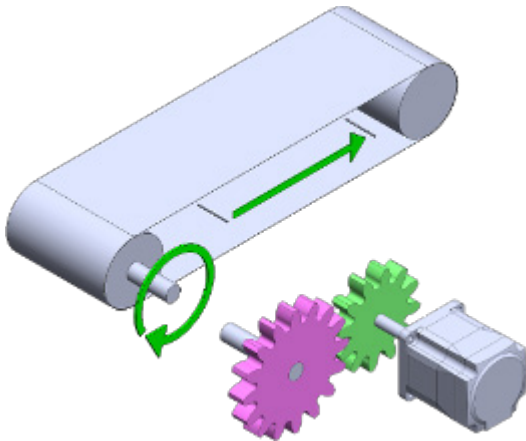

The user-defined position unit can be set as follows using the "User-defined position unit setting" and "Mechanism information specifications" parameters.

"Mechanism information specifications" parameter	"User-defined position unit setting" parameter	User-defined position unit (mechanism)
No unit	Use mechanism unit (×1)	[1 × no unit]
	Use mechanism unit (×0.1)	[0.1 × no unit]
	Use mechanism unit (×0.01)	[0.01 × no unit]
	Use mechanism unit (×0.001)	[0.001 × no unit]

● Gear ratio

The gear ratio can be set using the "Gear information (numerator)" and "Gear information (denominator)" parameters.

$$\text{Gear ratio} = \frac{\text{Gear information (numerator)}}{\text{Gear information (denominator)}}$$



• Setting example

If the velocity of the driving shaft of the gearbox is set to one twentieth, the gear ratio is 20.

Example:

$$\text{Gear ratio } 20 = \frac{20}{1}$$

- In the case of a geared motor, information of the gearhead is written to the motor (encoder) in advance. For details, refer to "1-6 Unit setting of geared motor" on p.30.

● Mechanism information

Use the "Mechanism information (numerator)" and "Mechanism information (denominator)" parameters to set the travel amount per revolution of the driving shaft of the gearbox [no unit/rev].

$$\text{Travel amount per revolution of driving shaft of gearbox [no unit/rev]} = \frac{\text{Mechanism information (numerator)}}{\text{Mechanism information (denominator)}} \text{ [no unit/rev]}$$

● Control resolution

$$\text{Control resolution (P/R)} = \frac{\text{Travel amount per revolution of driving shaft of gearbox}}{\text{User-defined position unit (mechanism)}} \times \frac{1}{\text{Gear ratio}}$$

Note that the calculated value must fall within the setting range specified below.

Setting range of control resolution: 500 to 36,000 P/R (initial value: 36,000 P/R)



If a resolution out of the setting range is set, information of "Unit setting" will be generated. If the power supply is turned on again or Configuration is executed in a state where information of "Unit setting" is being generated, an alarm of "Unit setting error" will be generated.

■ **When "Linear motion [mm], setting: travel amount [mm/rev]" is selected in Mechanism information specifications**

Select when a linear motion mechanism is assembled to the driving shaft of the gearbox.

Illustration example

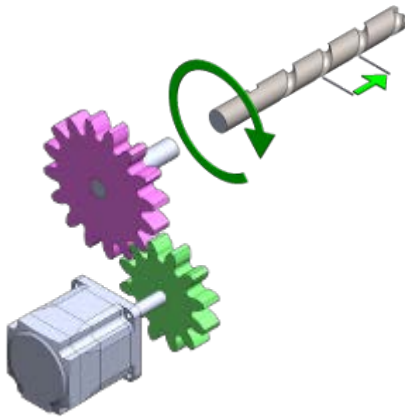

The user-defined position unit can be set as follows using the "User-defined position unit setting" and "Mechanism information specifications" parameters.

"Mechanism information specifications" parameter	"User-defined position unit setting" parameter	User-defined position unit (mechanism)
Linear motion [mm], setting: travel amount [mm/rev]	Use mechanism unit (×1)	[1 × mm]
	Use mechanism unit (×0.1)	[0.1 × mm]
	Use mechanism unit (×0.01)	[0.01 × mm]
	Use mechanism unit (×0.001)	[0.001 × mm]

● **Gear ratio**

The gear ratio can be set using the "Gear information (numerator)" and "Gear information (denominator)" parameters.

$$\text{Gear ratio} = \frac{\text{Gear information (numerator)}}{\text{Gear information (denominator)}}$$



- **Setting example**
If the velocity of the driving shaft of the gearbox is set to one twentieth, the gear ratio is 20. Example: Gear ratio 20 = $\frac{20}{1}$
- In the case of a geared motor, information of the gearhead is written to the motor (encoder) in advance. For details, refer to "1-6 Unit setting of geared motor" on p.30.

● **Mechanism information**

Use the "Mechanism information (numerator)" and "Mechanism information (denominator)" parameters to set the travel amount per revolution of the driving shaft of the gearbox [mm/rev].

$$\text{Travel amount per revolution of driving shaft of gearbox [mm/rev]} = \frac{\text{Mechanism information (numerator)}}{\text{Mechanism information (denominator)}} \text{ [mm/rev]}$$

● Control resolution

$$\text{Control resolution (P/R)} = \frac{\text{Travel amount per revolution of driving shaft of gearbox}}{\text{User-defined position unit (mechanism)}} \times \frac{1}{\text{Gear ratio}}$$

Note that the calculated value must fall within the setting range specified below.

Setting range of control resolution: 500 to 36,000 P/R (initial value: 36,000 P/R)

Note If a resolution out of the setting range is set, information of "Unit setting" will be generated. If the power supply is turned on again or Configuration is executed in a state where information of "Unit setting" is being generated, an alarm of "Unit setting error" will be generated.

■ When "Wheel [mm], setting: diameter [mm]" is selected in Mechanism information specifications

Select when a mechanism having assembled a wheel on the driving shaft of the gearbox is used.

Illustration example

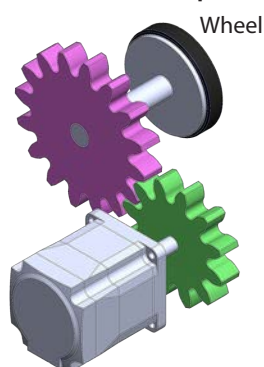

The user-defined position unit can be set as follows using the "User-defined position unit setting" and "Mechanism information specifications" parameters.

"Mechanism information specifications" parameter	"User-defined position unit setting" parameter	User-defined position unit (mechanism)
Wheel [mm], setting: diameter [mm]	Use mechanism unit (×1)	[1 × mm]
	Use mechanism unit (×0.1)	[0.1 × mm]
	Use mechanism unit (×0.01)	[0.01 × mm]
	Use mechanism unit (×0.001)	[0.001 × mm]

● Gear ratio

The gear ratio can be set using the "Gear information (numerator)" and "Gear information (denominator)" parameters.

$$\text{Gear ratio} = \frac{\text{Gear information (numerator)}}{\text{Gear information (denominator)}}$$

- memo**
- Setting example
If the velocity of the driving shaft of the gearbox is set to one twentieth, the gear ratio is 20. Example: Gear ratio 20 = $\frac{20}{1}$
 - In the case of a geared motor, information of the gearhead is written to the motor (encoder) in advance. For details, refer to "1-6 Unit setting of geared motor" on p.30.

● Mechanism information

Use the "Mechanism information (numerator)" and "Mechanism information (denominator)" parameters to set the diameter of the wheel assembled on the driving shaft of the gearbox [mm].

$$\text{Diameter of wheel assembled on driving shaft of gearbox [mm]} = \frac{\text{Mechanism information (numerator)}}{\text{Mechanism information (denominator)}} \text{ [mm]}$$

● **Control resolution**

$$\text{Control resolution (P/R)} = \frac{\text{Diameter of wheel assembled on driving shaft of gearbox} \times \pi}{\text{User-defined position unit (mechanism)}} \times \frac{1}{\text{Gear ratio}}$$

Note that the calculated value must fall within the setting range specified below.
 Setting range of control resolution: 500 to 36,000 P/R (initial value: 36,000 P/R)

Note If a resolution out of the setting range is set, information of "Unit setting" will be generated.
 If the power supply is turned on again or Configuration is executed in a state where information of "Unit setting" is being generated, an alarm of "Unit setting error" will be generated.

■ **When "Rotation [rev], setting: mechanism reduction ratio" is selected in Mechanism information specifications**

Select when a rotating mechanism having assembled a speed reduction or speed increasing mechanism on the driving shaft of the gearbox is used.

Illustration example

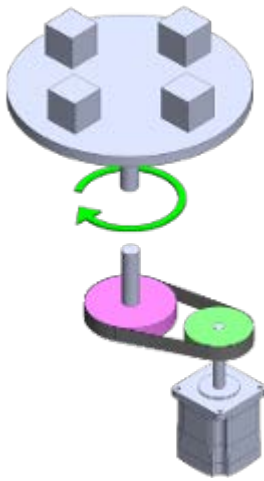

The user-defined position unit can be set as follows using the "User-defined position unit setting" and "Mechanism information specifications" parameters.

"Mechanism information specifications" parameter	"User-defined position unit setting" parameter	User-defined position unit (mechanism)
Rotation [rev], setting: mechanism reduction ratio	Use mechanism unit (×1)	[1 × rev]
	Use mechanism unit (×0.1)	[0.1 × rev]
	Use mechanism unit (×0.01)	[0.01 × rev]
	Use mechanism unit (×0.001)	[0.001 × rev]

● **Gear ratio**

The gear ratio can be set using the "Gear information (numerator)" and "Gear information (denominator)" parameters.

$$\text{Gear ratio} = \frac{\text{Gear information (numerator)}}{\text{Gear information (denominator)}}$$

memo ● Setting example
 If the velocity of the driving shaft of the gearbox is set to one twentieth, the gear ratio is 20. Example: Gear ratio 20 = $\frac{20}{1}$

● In the case of a geared motor, information of the gearhead is written to the motor (encoder) in advance. For details, refer to "1-6 Unit setting of geared motor" on p.30.

- **Mechanism information**

Use the "Mechanism information (numerator)" and "Mechanism information (denominator)" parameters to set the gear ratio (mechanism reduction ratio) of the mechanism assembled on the driving shaft of the gearbox.

$$\text{Mechanism reduction ratio} = \frac{\text{Mechanism information (numerator)}}{\text{Mechanism information (denominator)}}$$

- **Control resolution**

$$\text{Control resolution (P/R)} = \frac{1}{\text{User-defined position unit (mechanism)}} \times \frac{1}{\text{Gear ratio}} \times \frac{1}{\text{Mechanism reduction ratio}}$$

Note that the calculated value must fall within the setting range specified below.
Setting range of control resolution: 500 to 36,000 P/R (initial value: 36,000 P/R)

Note If a resolution out of the setting range is set, information of "Unit setting" will be generated.
If the power supply is turned on again or Configuration is executed in a state where information of "Unit setting" is being generated, an alarm of "Unit setting error" will be generated.

- **When "Rotation [deg], setting: mechanism reduction ratio" is selected in Mechanism information specifications**

Select when a rotating mechanism having assembled a speed reduction or speed increasing mechanism on the driving shaft of the gearbox is used.

Illustration example

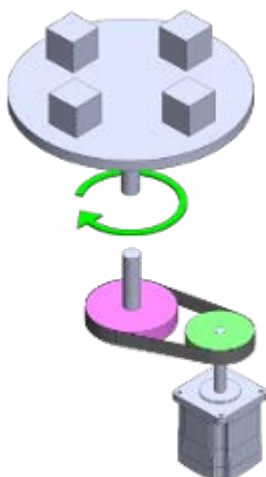

The user-defined position unit can be set as follows using the "User-defined position unit setting" and "Mechanism information specifications" parameters.

"Mechanism information specifications" parameter	"User-defined position unit setting" parameter	User-defined position unit (mechanism)
Rotation [deg], setting: mechanism reduction ratio	Use mechanism unit (×1)	[1 × deg]
	Use mechanism unit (×0.1)	[0.1 × deg]
	Use mechanism unit (×0.01)	[0.01 × deg]
	Use mechanism unit (×0.001)	[0.001 × deg]

- **Gear ratio**

The gear ratio can be set using the "Gear information (numerator)" and "Gear information (denominator)" parameters.

$$\text{Gear ratio} = \frac{\text{Gear information (numerator)}}{\text{Gear information (denominator)}}$$



- **Setting example**

If the velocity of the driving shaft of the gearbox is set to one twentieth, the gear ratio is 20.

Example:

$$\text{Gear ratio } 20 = \frac{20}{1}$$

- In the case of a geared motor, information of the gearhead is written to the motor (encoder) in advance. For details, refer to "1-6 Unit setting of geared motor" on p.30.

- **Mechanism information**

Use the "Mechanism information (numerator)" and "Mechanism information (denominator)" parameters to set the gear ratio (mechanism reduction ratio) of the mechanism assembled on the driving shaft of the gearbox.

$$\text{Mechanism reduction ratio} = \frac{\text{Mechanism information (numerator)}}{\text{Mechanism information (denominator)}}$$

- **Control resolution**

$$\text{Control resolution (P/R)} = \frac{360}{\text{User-defined position unit (mechanism)}} \times \frac{1}{\text{Gear ratio}} \times \frac{1}{\text{Mechanism reduction ratio}}$$

Note that the calculated value must fall within the setting range specified below.

Setting range of control resolution: 500 to 36,000 P/R (initial value: 36,000 P/R)



If a resolution out of the setting range is set, information of "Unit setting" will be generated. If the power supply is turned on again or Configuration is executed in a state where information of "Unit setting" is being generated, an alarm of "Unit setting error" will be generated.

■ Related parameters

Parameter name	Description	Initial setting	
		Initial value	Unit
User-defined position unit setting	Sets the position unit. [Setting range] 0: Encoder setting is prioritized (Use [Control resolution] if not a mechanical product) 1: Control resolution (step) 10: Use mechanism unit (×1) 11: Use mechanism unit (×0.1) 12: Use mechanism unit (×0.01) 13: Use mechanism unit (×0.001) 23: 0.001 rev (driving shaft of gearbox) 24: 0.0001 rev (driving shaft of gearbox) 25: 0.00001 rev (driving shaft of gearbox) 26: 0.000001 rev (driving shaft of gearbox) 31: 0.1 deg (driving shaft of gearbox) 32: 0.01 deg (driving shaft of gearbox) 33: 0.001 deg (driving shaft of gearbox) 34: 0.0001 deg (driving shaft of gearbox)	0	–
Motor rotation direction	Sets the rotation direction of the motor shaft. [Setting range] 0: Not invert 1: Invert	0	–
Control resolution (numerator)	Sets the numerator of the control resolution. [Setting range] 500 to 67,108,863	36,000	–
Control resolution (denominator)	Sets the denominator of the control resolution. [Setting range] 1 to 65,535	1	–
Gear information (numerator)	Sets the numerator of the gear ratio. [Setting range] 1 to 1000	1	–
Gear information (denominator)	Sets the denominator of the gear ratio. [Setting range] 1 to 1000	1	–
Gear rotation direction	Sets the rotation direction of the driving shaft of the gearbox. [Setting range] 0: Not invert 1: Invert	0	–

Parameter name	Description	Initial setting	
		Initial value	Unit
Mechanism information specifications	Sets the mechanism information specifications. [Setting range] 0: Encoder setting is prioritized (if not a mechanical product, no unit) 1: Encoder setting is prioritized (if not a mechanical product, linear motion [mm], setting: travel amount [mm/rev]) 2: Encoder setting is prioritized (if not a mechanical product, wheel [mm], setting: diameter [mm]) 5: Encoder setting is prioritized (if not a mechanical product, rotation [rev], setting: mechanism reduction ratio) 6: Encoder setting is prioritized (if not a mechanical product, rotation [deg], setting: mechanism reduction ratio) 8: No unit 9: Linear motion [mm], setting: travel amount [mm/rev] 10: Wheel [mm], setting: diameter [mm] 13: Rotation [rev], setting: mechanism reduction ratio 14: Rotation [deg], setting: mechanism reduction ratio	2	–
Mechanism information (numerator)	Sets the numerator of mechanism information. [Setting range] 1 to 65,535	1	–
Mechanism information (denominator)	Sets the denominator of mechanism information. [Setting range] 1 to 65,535	1	–
Mechanism traveling direction	Sets the travel direction of the mechanism. [Setting range] 0: Not invert 1: Invert	0	–

1-3 User-defined velocity unit setting

Setting the "User-defined velocity unit setting" parameter can set the user-defined velocity unit. The user-defined velocity unit having set is used as a unit of the demand velocity or the actual velocity for operation. The user-defined velocity unit cannot be set depending on a combination of the "User-defined velocity unit setting," "Control resolution," and "Gear ratio" parameters. Information of "Unit setting" is generated if a combination that cannot be set is selected.

Note If the power supply is turned on again or Configuration is executed in a state where information of "Unit setting" is being generated, an alarm of "Unit setting error" will be generated.

Related parameter

Parameter name	Description	Initial setting	
		Initial value	Unit
User-defined velocity unit setting	Sets the velocity unit. [Setting range] 0: Position unit is "Control resolution": r/min (motor shaft), others: position unit/s 1: Position unit/s 2: r/min (motor shaft) 11: 0.1 r/min (motor shaft) 12: 0.01 r/min (motor shaft) 20: 1 r/min (driving shaft of gearbox) 21: 0.1 r/min (driving shaft of gearbox) 22: 0.01 r/min (driving shaft of gearbox) 23: 0.001 r/min (driving shaft of gearbox) 24: 0.0001 r/min (driving shaft of gearbox) 25: 0.00001 r/min (driving shaft of gearbox)	0	—

■ User-defined velocity unit setting range

● When "**** (motor shaft)" is set

Information of "Unit setting" is generated if the following condition is satisfied.

$$\text{Condition: Control resolution (P/R)} \times \frac{\text{User-defined velocity unit setting [r/min]}}{60} < 1 \text{ [step/s]}$$

Set the control resolution and the setting unit so that the calculation result is greater than 1.

<Setting example>

Parameter	Setting value
User-defined velocity unit setting	12: 0.01 r/min (motor shaft)
Control resolution	36,000 [P/R]

Calculation result

$$\frac{36,000 \text{ [P/R]} \times 0.01 \text{ [r/min]}}{60} = 6$$

The calculation result is "6." This value is greater than 1, so an alarm or information will not be generated.

Note If the power supply is turned on again or Configuration is executed in a state where information of "Unit setting" is being generated, an alarm of "Unit setting error" will be generated.

- **When "**** (driving shaft of gearbox)" is set**

Information of "Unit setting" is generated if one of the following conditions is satisfied.

Condition 1) User velocity unit [r/min] × Gear ratio ≥ 10 [r/min] (motor shaft)

Condition 2) Control resolution (P/R) × $\frac{\text{User-defined velocity unit setting [r/min]}}{60}$ × Gear ratio < 1 [step/s]

The gear ratio can be set using the "Gear information (numerator)" and "Gear information (denominator)" parameters.

Gear ratio = $\frac{\text{Gear information (numerator)}}{\text{Gear information (denominator)}}$

<Setting example>

Parameter	Setting value
User-defined velocity unit setting	23: 0.001 r/min (driving shaft of gearbox)
Control resolution	6,000 [P/R]
Gear ratio	20

Calculation result

Condition 1) 0.001 [r/min] × 20 = 0.02 < 10 [r/min]

Condition 2) $\frac{6,000 \text{ [P/R]} \times 0.001 \text{ [r/min]} \times 20}{60} = 2 \geq 1 \text{ [step/s]}$

An alarm or information will not be generated since both the conditions 1) and 2) are not satisfied from the calculation result.



If the power supply is turned on again or Configuration is executed in a state where information of "Unit setting" is being generated, an alarm of "Unit setting error" will be generated.

1-4 User-defined acceleration/deceleration unit

Setting the "User-defined acceleration/deceleration unit setting" parameter can set the user-defined acceleration/deceleration unit.

The user-defined acceleration/deceleration unit having set is used as a unit of the acceleration or the deceleration for operation.



"(User-defined velocity unit)/s" is fixed in operation by the drive profile (CAN communication).

Related parameter

Parameter name	Description	Initial setting	
		Initial value	Unit
User-defined acceleration/deceleration unit setting (DD, FWRV, SD, HOME operation)	Sets the acceleration/deceleration unit. This parameter is not applied when the product is operated with the drive profile (CAN communication). [Setting range] 0: (User-defined velocity unit)/s 1: ms	1	–

When "0: (User-defined velocity unit)/s" is set

Operating velocity [User-defined velocity unit]

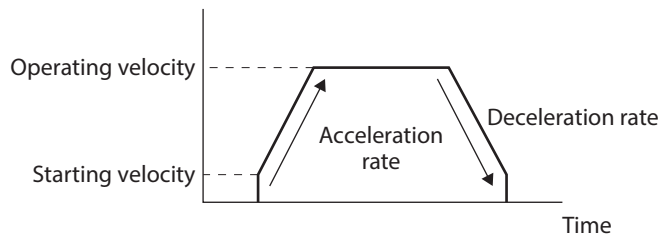

When "1: ms" is set

Operating velocity [User-defined velocity unit]

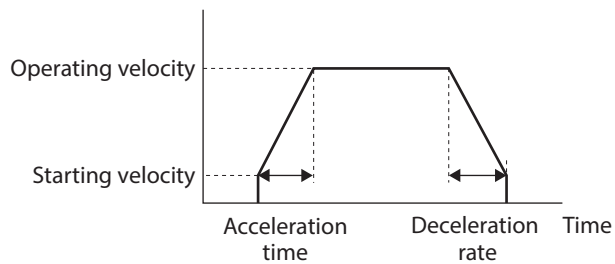

1-5 Coordinate direction

The objects of the position demand and velocity demand are changed using the "User-defined position unit setting" parameter and the "User-defined velocity unit setting" parameter.

Setting of "User-defined position unit setting" parameter	Object of position demand (position coordinate)
Control resolution (step)	Motor shaft
*** rev (driving shaft of gearbox) *** deg (driving shaft of gearbox)	Driving shaft of gearbox
Use mechanism unit (× ***)	Position of moving part of mechanism
Setting of "User-defined velocity unit setting" parameter	Object of velocity demand (velocity coordinate)
Position unit/s	Same as the object of position demand
*** r/min (motor shaft)	Motor shaft
*** r/min (driving shaft of gearbox)	Driving shaft of gearbox

If the actual motor rotation direction is different between the position coordinate direction and the velocity coordinate direction, the position coordinate direction follows the velocity coordinate direction. Changing the "Position/velocity coordinate direction" parameter can change the relation between the position coordinate direction and the velocity coordinate direction.

■ Motor rotation direction (velocity coordinate)

● Object of velocity demand: In the case of motor shaft

This is a mode to control the motor shaft directly.

The velocity can be commanded based on the motor shaft.

The actual motor rotation direction follows the setting of the following parameter.

- "Motor rotation direction" parameter

● Object of velocity demand: In the case of driving shaft of gearbox

This is a mode to control the driving shaft of the gearbox that a gear is installed to the motor shaft.

The velocity can be commanded based on the driving shaft of the gearbox.

The actual motor rotation direction follows the result composited the settings of the following parameters.

If the parameters are all set to "Invert," the rotation direction is not inverted due to "Invert × Invert."

- "Motor rotation direction" parameter
- "Gear rotation direction" parameter

● Object of velocity demand: In the case of velocity of moving part of mechanism

This is a mode to control the moving part of the mechanism when the mechanism is installed to the driving shaft of the gearbox installed to the motor shaft.

The velocity can be commanded based on the moving part of the mechanism.

The actual motor rotation direction follows the result composited the settings of the following parameters.

If the parameters are all set to "Invert," the rotation direction is inverted due to "Invert × Invert × Invert."

- "Motor rotation direction" parameter
- "Gear rotation direction" parameter
- "Mechanism traveling direction" parameter

■ Motor rotation direction (position coordinate)

This is the same as the velocity.

■ Torque coordinate direction

The torque coordinate direction follows the velocity coordinate direction.

Changing the "Torque coordinate direction" parameter can change the torque coordinate direction to the position coordinate direction.

■ Related parameters

Parameter name	Description	Initial setting	
		Initial value	Unit
User-defined position unit setting	Sets the position unit. [Setting range] 0: Encoder setting is prioritized (Use [Control resolution] if not a mechanical product) 1: Control resolution (step) 10: Use mechanism unit (×1) 11: Use mechanism unit (×0.1) 12: Use mechanism unit (×0.01) 13: Use mechanism unit (×0.001) 23: 0.001 rev (driving shaft of gearbox) 24: 0.0001 rev (driving shaft of gearbox) 25: 0.00001 rev (driving shaft of gearbox) 26: 0.000001 rev (driving shaft of gearbox) 31: 0.1 deg (driving shaft of gearbox) 32: 0.01 deg (driving shaft of gearbox) 33: 0.001 deg (driving shaft of gearbox) 34: 0.0001 deg (driving shaft of gearbox)	0	–
User-defined velocity unit setting	Sets the velocity unit. [Setting range] 0: Position unit is "Control resolution": r/min (motor shaft), others: position unit/s 1: Position unit/s 2: r/min (motor shaft) 11: 0.1 r/min (motor shaft) 12: 0.01 r/min (motor shaft) 20: 1 r/min (driving shaft of gearbox) 21: 0.1 r/min (driving shaft of gearbox) 22: 0.01 r/min (driving shaft of gearbox) 23: 0.001 r/min (driving shaft of gearbox) 24: 0.0001 r/min (driving shaft of gearbox) 25: 0.00001 r/min (driving shaft of gearbox)	0	–
Motor rotation direction	Sets the rotation direction of the motor shaft. [Setting range] 0: Not invert 1: Invert	0	–
Gear rotation direction	Sets the rotation direction of the driving shaft of the gearbox. [Setting range] 0: Not invert 1: Invert	0	–
Mechanism traveling direction	Sets the travel direction of the mechanism. [Setting range] 0: Not invert 1: Invert	0	–
Position/velocity coordinate direction	Sets directions for the position coordinate and the velocity coordinate. [Setting range] 0: Follow unit setting 1: Match the direction of velocity coordinate with position coordinate 2: Match the direction of position coordinate with velocity coordinate	2	–
Torque coordinate direction	Selects the coordinate to be used as a reference with the torque monitor. [Setting range] 0: Based on position coordinate 1: Based on velocity coordinate	1	–

1-6 Unit setting of geared motor

In the case of a geared motor, information of the gearhead is written to the motor (encoder) in advance. Therefore, the following parameters are automatically applied to the unit setting even if a setting is not made.

- "Gear information (numerator)" parameter
- "Gear information (denominator)" parameter
- "Gear rotation direction" parameter



- In the case of motors of the combination type, information of the gearhead is not written to the motor (encoder).
- If the "Gear information (numerator)" parameter or the "Gear information (denominator)" parameter is changed from the initial value "1," the value set in the parameter is prioritized.
- If information of the gearhead written to the motor (encoder) is not used, set the "Gear information (numerator)" parameter or the "Gear information (denominator)" parameter.
- If the reduction ratio of the entire equipment is desired to set only with the "Mechanism information (numerator)" parameter and the "Mechanism information (denominator)" parameter, set the "Gear information (numerator)" parameter and the "Gear information (denominator)" parameter to the same value such as 2.
The information of the gearhead written to the motor (encoder) can be disabled.

● How to check

Information of the gearhead applied to the unit setting can be checked with the "Unit information monitor" of the support software.

If information of the gearhead written to the motor (encoder) is applied, the "Gear setting" will be "Encoder." When the parameter setting value is applied, the "Gear setting" will be "Parameter."

8-16	Gear setting	Encoder
8-17	Gear information (numerator)(Applicable value)	10
8-18	Gear information (denominator)(Applicable value)	1
8-19	Gear rotation direction(Applicable value)	Non invert

2 Coordinates management

2-1 Coordinate home positions

There are two types of home positions, a mechanical home and an electrical home. When coordinates are set, the ABSPEN output is turned ON.



The following operation cannot be executed if coordinates are not set. Absolute positioning operation (when the "Permission of absolute positioning without setting absolute coordinates" parameter is "Disable")

Related parameter

Parameter name	Description	Initial setting	
		Initial value	Unit
Permission of absolute positioning without setting absolute coordinates	Permits absolute positioning operation in a state where coordinates are not set. [Setting range] 0: Disable 1: Enable	0	–

■ Mechanical home

The mechanical home is a home that is set by homing operation or the position preset.

■ Mechanical home setting

To set the mechanical home coordinates, perform the position preset or homing operation. If the mechanical home coordinates are set, operation is performed on the coordinates centered on the mechanical home.

● Position preset

The demand position and the actual position will be a value obtained by subtracting a value of the "Home offset" parameter from the home, and the home is set.

Related parameter

Parameter name	Description	Initial setting	
		Initial value	Unit
Home offset	Sets the amount of offset from the home when homing operation is completed or P-PRESET is executed. [Setting range] –2,147,483,648 to 2,147,483,647 (User-defined position unit)	0	step

● Homing operation

Performing homing operation can set the mechanical home.

■ Electrical home

The electrical home is a home that is set in the driver. When the EL-PRST input is turned ON, the electrical home is set, and the motor operates on the coordinate system with the electrical home as the home. If the EL-PRST input is turned OFF, the electrical home is cleared. The ELPRST-MON output is being ON while the electrical home is set.

■ **Electrical home setting**

The demand position when the EL-PRST input is turned from OFF to ON will be the electrical home. While the EL-PRST input is being ON, operation is performed on the coordinates centered on the electrical home. When the position preset or homing operation is performed in a state where the EL-PRST input is an ON state, the mechanical home and the electrical home will simultaneously be a value subtracted a value of the "Home offset" parameter from the home. Turning the EL-PRST input from ON to OFF returns to the mechanical home coordinates.

■ **A state where coordinates are not set**

Coordinates will be an unset state in the following cases. The ABSPEN output is turned OFF.

- When the main power supply is turned on
- After Configuration was executed.

2-2 WRAP Function

The WRAP function is a function to automatically preset the position information of the present position when the position exceeds the set range. Setting the upper limit and the lower limit of the WRAP setting can restrict the operation area of equipment or control an index table with coordinates on the positive and negative sides.

Related parameters

Parameter name	Description	Initial setting	
		Initial value	Unit
WRAP setting	Sets the WRAP setting. [Setting range] 1: 32-bit range (WRAP-type operation disabled/WRAP-ZERO output disabled) 2: Follows WRAP setting lower limit/WRAP setting upper limit	1	-
WRAP setting lower limit	Sets the lower limit value of the WRAP setting. [Setting range] -536,870,912 to 0 (User-defined position unit)	0	step
WRAP setting upper limit	Sets the upper limit value of the WRAP setting. [Setting range] 0 to 536,870,911 (User-defined position unit)	0	step

- memo**
- If both the "WRAP setting lower limit" and "WRAP setting upper limit" are set to "0," the WRAP setting will be set to "32-bit range."
 - When the WRAP setting is "32-bit range," an alarm of "Operation data error" will be generated if operation related WRAP is executed.

■ **When "32-bit range" is set**

The position goes around between -2,147,483,648 and 2,147,483,647.

It shows 2,147,483,647 after -2,147,483,648, and after that it shows in descending order.

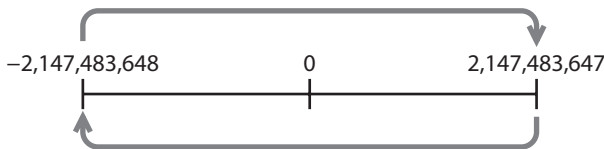

It shows -2,147,483,648 after 2,147,483,647, and after that it shows in ascending order.

■ When "Follows WRAP setting lower limit/WRAP setting upper limit" is set

The position goes around between the "WRAP setting lower limit" and the "WRAP setting upper limit."

● Setting example

If parameters are set as shown in the table below, the motor can be operated on the coordinates shown in the figure.

Item	Setting
WRAP setting	2: Follows WRAP setting lower limit/WRAP setting upper limit
WRAP setting lower limit	-6000
WRAP setting upper limit	5999

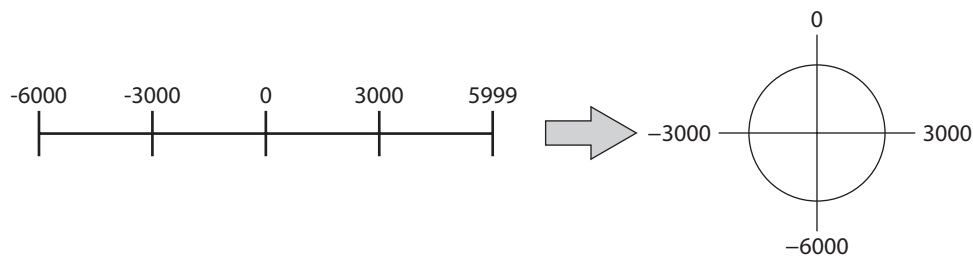

Related output signals

- WRAP-ZERO output (p.199)
- WRAP-OVF output (p.199)

3 Stopping movement

3-1 Operation stop input

When the operation stop signal is input during motor operation, the motor stops.

Related parameters

Parameter name	Description	Initial setting	
		Initial value	Unit
FW-BLK/RV-BLK input action	Sets how to stop the motor when the FW-BLK input or the RV-BLK input is turned ON. [Setting Range] 0: Immediate stop 1: Deceleration stop (according to the operation profile during operation) 2: Follow QSTOP setting (current is not cut off) 3: Follow STOP setting	1	–
STOP input action	Sets how to stop the motor when the STOP input is turned ON. [Setting range] –3: Deceleration time stop (according to the Custom stopping time parameter) –2: Deceleration rate stop (according to the Custom stopping rate parameter) –1: Immediate stop 1: Deceleration stop (according to the operation profile during operation except for the torque limiting value) 2: Deceleration rate stop (according to the Quick stop rate parameter)	1	–
STOP input stopping Torque limit value	Sets the torque limiting value when the STOP input is turned ON. [Setting range] 0: Use profile torque limit continuously 1 to 10,000 (1=0.1%)	0	1=0.1%
QSTOP input action	Sets how to stop the motor when the QSTOP input is turned ON. [Setting range] –3: Deceleration time stop (according to the Custom stopping time parameter) –2: Deceleration rate stop (according to the Custom stopping rate parameter) –1: Immediate stop 0: Immediate stop (current is cut off after stopping) 1: Deceleration stop (according to the operation profile during operation except for the torque limiting value) (current is cut off after stopping) 2: Deceleration rate stop (according to the Quick stop rate parameter) (current is cut off after stopping) 5: Deceleration stop (according to the operation profile during operation except for the torque limiting value) 6: Deceleration rate stop (according to the Quick stop rate parameter)	2	–

Parameter name	Description	Initial setting	
		Initial value	Unit
QSTOP input stopping Torque limit value	Sets the torque limiting value when the QSTOP input is turned ON. [Setting range] 0: Use profile torque limit continuously 1 to 10,000 (1=0.1%)	0	1=0.1%
Quick stop rate	Sets the deceleration rate when "Deceleration rate stop (according to the Quick stop rate parameter)" is selected in the "STOP input action" and "QSTOP input action" parameters. [Setting range] 1 to 1,000,000,000 (User-defined velocity unit/s)	1,000	(r/min)/s
Custom stopping rate	Sets the deceleration rate when "Deceleration rate stop (according to the Custom stopping rate parameter)" is selected in the "STOP input action" and "QSTOP input action" parameters. [Setting range] 1 to 1,000,000,000 (User-defined velocity unit/s)	1,000	(r/min)/s
Custom stopping time	Sets the deceleration time when "Deceleration time stop (according to the Custom stopping time parameter)" is selected in the "STOP input action" and "QSTOP input action" parameters. [Setting range] 1 to 1,000,000,000 ms	1,000	ms

3-2 Hardware overtravel

Hardware overtravel is a function that limits the range of movement by installing the limit sensors (FW-LS, RV-LS) at the upper and lower limits of the moving range. If the "FW-LS/RV-LS input action" parameter is set, the motor can be stopped when the limit sensor is detected.

Related parameter

Parameter name	Description	Initial setting	
		Initial value	Unit
FW-LS/RV-LS input action	Sets how to stop the motor when the FW-LS input or the RV-LS input is turned ON. [Setting Range] -1: Only for homing sensor 0: Immediate stop 1: Deceleration stop (according to the operation profile during operation) 2: Follow QSTOP setting (current is not cut off) 3: Follow STOP setting 4: Immediate stop with alarm 5: Deceleration stop with alarm (according to the operation profile during operation) 6: Follow QSTOP setting with alarm (current is not cut off) 7: Follow STOP setting with alarm	4	-



If the "FW-LS/RV-LS input action" parameter is set to an item describing "with alarm," the set values in the "Stopping method at alarm generation" parameter and the "FW-LS/RV-LS input action" parameter are compared, and the operation is stopped by the higher-priority stopping method.

3-3 Software overtravel

Software overtravel is a function that limits the range of movement by setting the upper and lower limits of the moving range by the parameters. When the demand position reaches the software limit, the motor can be stopped according to the setting of the "Software overtravel action" parameter. If the "Software overtravel action" parameter is set to an item describing "with alarm," an alarm of "Software overtravel" will be generated after the motor stops. Also, if the target position exceeds the software limit, an alarm of "Operation data error" will be generated.

Related parameters

Parameter name	Description	Initial setting	
		Initial value	Unit
Software overtravel action	Sets the operation when the demand position reaches the software limit. [Setting range] -1: Disable 0: Immediate stop 1: Deceleration stop (according to the operation profile during operation) 2: Follow QSTOP setting (current is not cut off) 3: Follow STOP setting 4: Immediate stop with alarm 5: Deceleration stop with alarm (according to the operation profile during operation) 6: Follow QSTOP setting with alarm (current is not cut off) 7: Follow STOP setting with alarm	6	-
Max software limit	Sets the maximum value of the software limit. [Setting range] -2,147,483,648 to 2,147,483,647 (User-defined position unit)	0	step
Min software limit	Sets the minimum value of the software limit. [Setting range] -2,147,483,648 to 2,147,483,647 (User-defined position unit)	0	step
Home offset	Sets the amount of offset from the home when homing operation is completed or P-PRESET is executed. [Setting range] -2,147,483,648 to 2,147,483,647 (User-defined position unit)	0	step
Valid position range	Sets the criterion of the software limit. [Setting range] 0: [Software limit] - [Home offset] (CiA402 compatible) 1: Software limit (AZ compatible)	0	-



- The software limit is enabled when coordinates are set.
If a value in the "Max software limit" parameter is set to equal or less than a value in the "Min software limit" parameter, an alarm of "Operation data error" due to the software overtravel and the software limit will be disabled.
In addition, if the software limit exceeds the WRAP setting range, an alarm of "Operation data error" due to the software overtravel of the exceeded direction and the software limit will be disabled.
- If the "Software overtravel action" parameter is set to an item describing "with alarm," the set values in the "Stopping method at alarm generation" parameter and the "Software overtravel action" parameter are compared, and the operation is stopped by the higher-priority stopping method.

3-4 Escape from the limit sensor

It is possible to escape in the reverse direction when the limit in the forward direction (FWD) is detected and in the forward direction when that in the reverse direction (RVS) is detected.

3-5 Priority of stop action

When multiple stop commands are input to the driver, the motor stops according to the following priority.

Priority	Stop level	Stopping movement	
High ↑ Low	0	Immediate stop	Stop by CLR input Immediate stop *1
	1	Deceleration stop *2	Deceleration stop when alarm is generated Deceleration stop when power supply for communication is lost Deceleration stop by maintenance command "Stop operation"
	2		Deceleration stop by QSTOP input
	3		Deceleration stop by FW-LS/RV-LS input *3 Deceleration stop by FW-BLK/RV-BLK input Deceleration stop by software overtravel *3
	4		Deceleration stop by STOP input
	5		Deceleration stop by stop operation

*1 When "Immediate stop" is selected in the stopping movement for each input signal

*2 For the same stop level, a larger value of the deceleration rate (faster stop) is prioritized.

*3 If the "FW-LS/RV-LS input action" parameter or the "Software overtravel action" parameter is set to an item describing "with alarm," the stop level will be "1."

- Note**
- In the following cases, immediate stop or deceleration stop cannot be executed using direct data operation.
 - While the motor is operating to stop by the operation stop signal
 - When the motor is operating by a method other than direct data operation
 - When combined with a gear, do not stop by the CLR input in a state where the motor shaft speed exceeds 300 r/min.

Example of operation

- **Operation when having input the QSTOP input (deceleration stop) while the motor was stopping by the STOP input (deceleration stop)**

The motor operates according to the QSTOP input due to high-priority input.

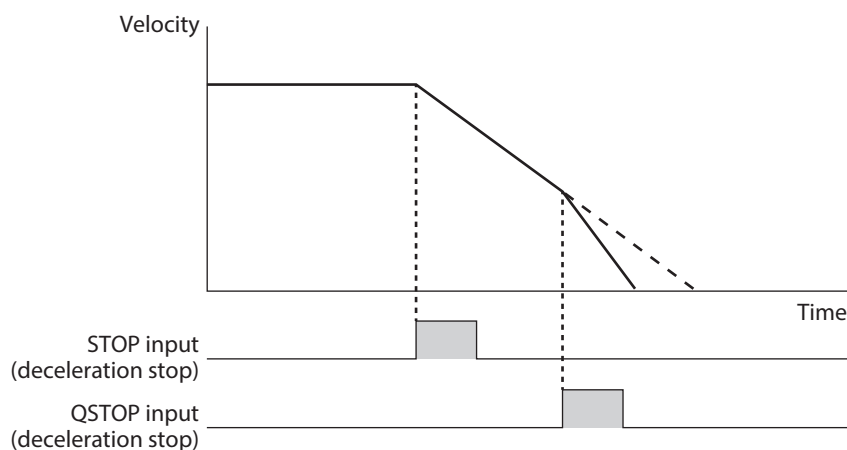

- **Operation when having input the STOP input (deceleration stop) while the motor was stopping by the QSTOP input (deceleration stop)**

Deceleration stop by the QSTOP input is continued because the QSTOP input has a higher stop priority.

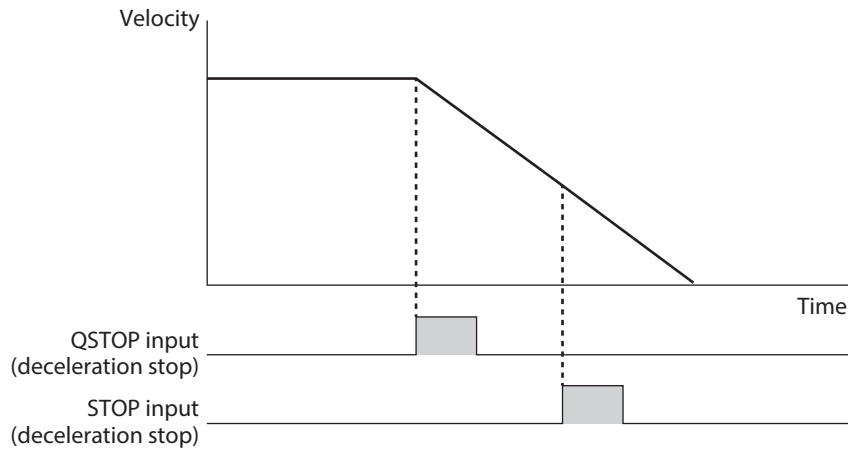

4 Torque limiting function

The maximum output torque of the motor can be limited.

Set when limiting the motor output torque according to a load.

The motor operates at the lowest torque limiting value among the following conditions.

Name	Description
Operation profile torque limiting	Torque limiting by the torque limiting value when operation is executed
TRQ-LMT input torque limiting	Torque limiting by the value set in the "TRQ-LMT input Torque limit value" parameter (when the TRQ-LMT input is ON)
ATL function torque limiting	Torque limiting by the ATL function (initial value: enable)
Stop command torque limiting	Torque limiting by the torque limiting value when the STOP input or the QSTOP input is turned ON
Alarm torque limiting	Torque limiting by the torque limiting value when an alarm is generated
Output power limiting	Limiting value when the main power supply is dropped

The maximum torque limiting value varies depending on the motor.

60 W motor: 200%

100 W motor: 220%

200 W motor: 210%

400 W motor: 200%



If the limit value is significantly increased during torque limiting, a large impact torque may be generated, causing damage to the motor or equipment. Beware of changing the limit value.

Related parameter

Parameter name	Description	Initial setting	
		Initial value	Unit
Torque limit setting at motor standstill	Selects the operating torque limit when the motor stops. [Setting range] 0: Follow the selection number 1: Maintain the previous operating torque limit (reset by excitation OFF)	1	–

5 ATL function

The ATL function is a function that prevents the overload alarm by automatically adjusting the torque limiting value when the output torque increases to near the overload alarm level.

■ When the torque limiting value larger than the overload detection torque is set

The ATL function activates when all of the following conditions are satisfied.

- The output torque of the motor exceeded the overload detection torque.
- The driver was estimated to exceed the overload detection time based on the output torque of the motor.

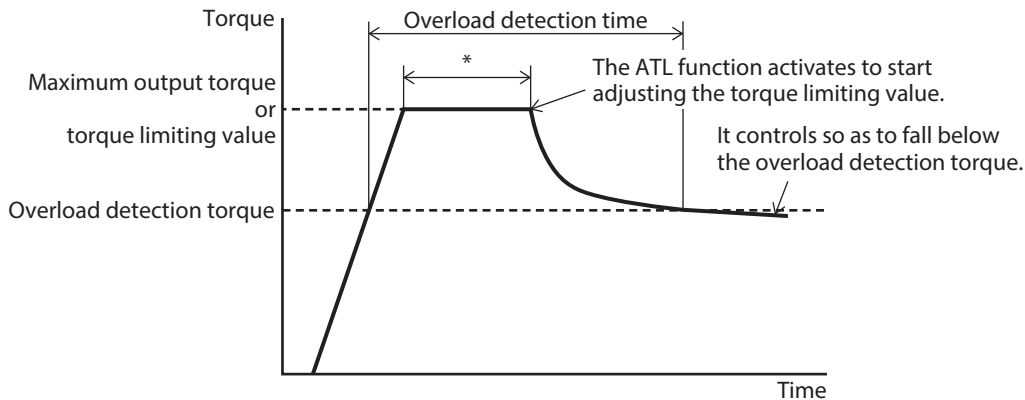

* The time varies depending on the operating condition or a load.

■ When the torque limiting value smaller than the overload detection torque is set

The ATL function is not activated because the motor output torque is smaller than the overload detection torque.

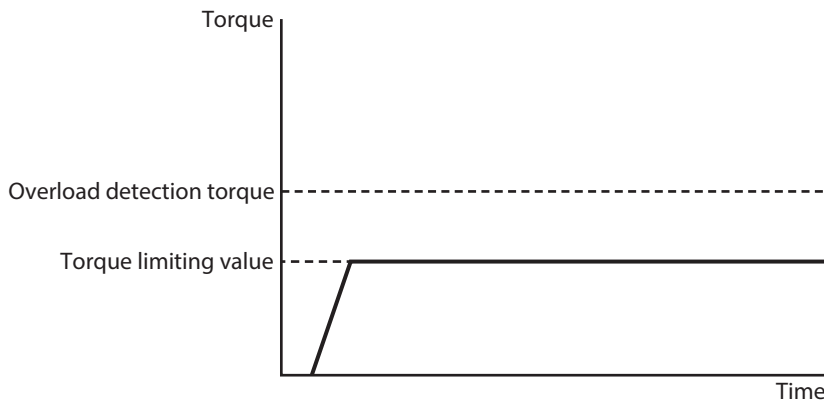

Note

If the ATL function is activated, the motor may not operate according to the operation profile. Make sure that changing the operation profile does not cause any problem in equipment beforehand.

Related parameter

Parameter name	Description	Initial setting	
		Initial value	Unit
ATL function mode setting	Selects the setting method of the ATL function. [Setting Range] 0: Follow ATL-EN input 1: ATL function enabled	1	–



• About ATL-EN Input
When the "ATL function mode setting" parameter is set to "Follow ATL-EN input," select whether to enable or disable the ATL function using the ATL-EN input. Turning the ATL-EN input ON enables the ATL function, and turning it OFF disables the ATL function.

● **Operation example: When load fluctuation occurs during continuous operation**

When ATL function is disabled

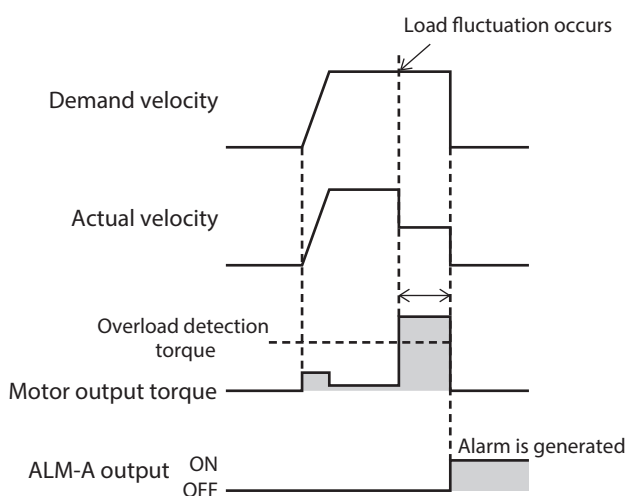

When ATL function is enabled

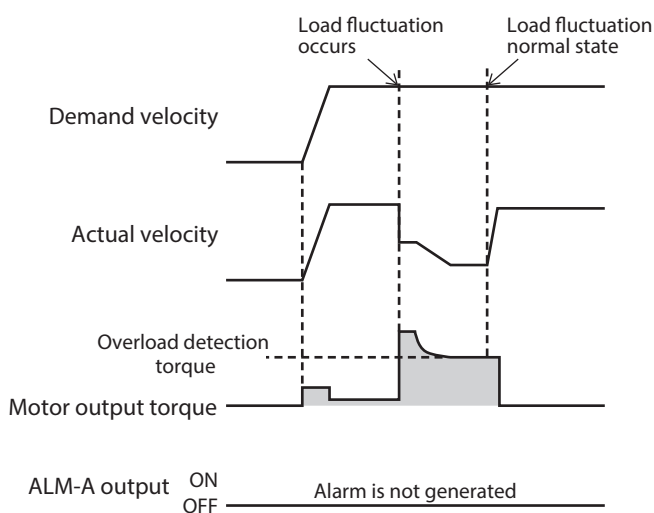

6 Driver status and motor excitation

■ Driver status and state transition of motor excitation

Driver status	Motor excitation	Electromagnetic brake	SON-MON output	PWR/SYS LED
Motor non-excitation	Non-excitation	Hold	OFF	White light
FREE	Non-excitation	Release	OFF	White light
Power removal with ETO	Non-excitation	Hold	OFF	Blinking white
ETO	Non-excitation	Hold	OFF	Blinking white
Alarm (non-excitation)	Non-excitation	Hold	OFF	Blinking red
Alarm (excitation)	Excitation	Release	ON	Blinking red
Motor excitation	Excitation	Release	ON	White light

Outline of ETO (External Torque Off)

When both the HWTO1 input and HWTO2 input are turned OFF, the driver transitions to the power removal status and concurrently with the "ETO" status.

At this time, the driver makes the motor put into a non-excitation state.

If both the HWTO1 input and HWTO2 input are turned ON, the power removal status is released, but the "ETO" status is retained without being released.

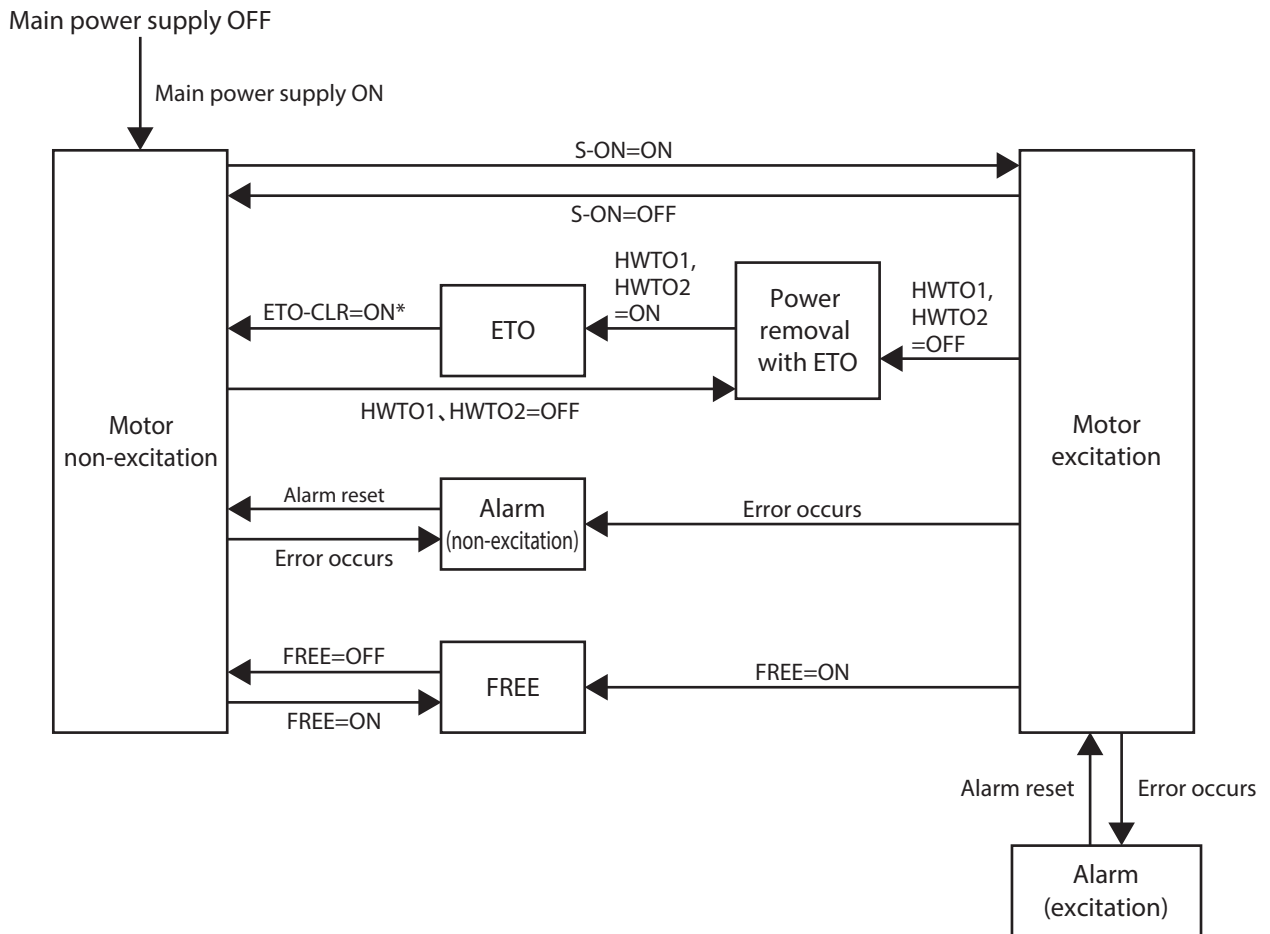

* If the parameter is changed, the "ETO" status can be released by the ALM-RST input, the S-ON input, or the STOP input.

Note The motor can be operated only when the driver status is in the "Motor excitation" status.

6-1 Driver status (motor non-excitation status)

Motor non-excitation

When the main power supply of the driver is turned on, the driver transitions to the "Motor non-excitation" status. The PWR/SYS LED is lit in white.

The motor puts into a non-excitation state.

When an electromagnetic brake motor is used, the electromagnetic brake actuates to hold the motor shaft.

Also, if the S-ON input is turned OFF while the driver status is in the "Motor excitation" status, the driver transitions to the "Motor non-excitation" status.

The SON-MON output is turned OFF.

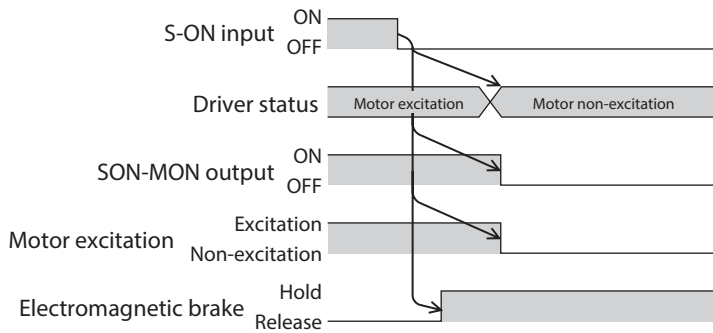

Note If the motor excitation is turned off to put into a non-excitation state while the motor is rotating, the motor, the driver, or the equipment may be damaged.

FREE

When the FREE input is turned ON, the driver transitions to the "FREE" status.

The PWR/SYS LED remains in white light.

The motor puts into a non-excitation state. Also, the SON-MON output is turned OFF.

When an electromagnetic brake motor is used, the electromagnetic brake is released.

If the FREE input is turned OFF, the driver transitions to the "Motor non-excitation" status.

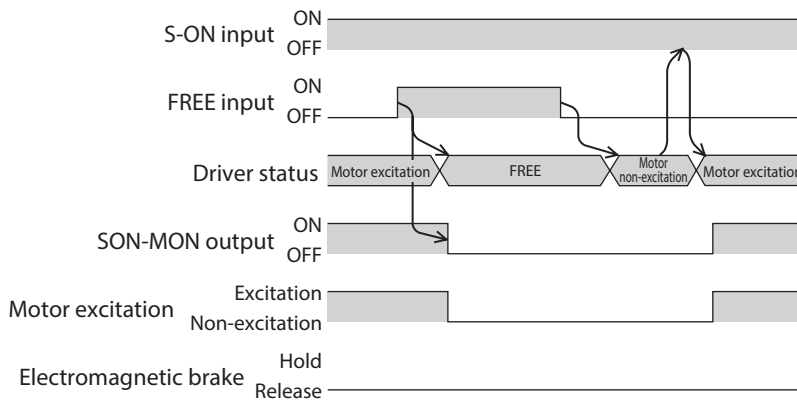

■ Alarm (non-excitation)

If the driver detects an alarm to put the motor into a non-excitation state, it transitions to the "Alarm (non-excitation)" status.

The PWR/SYS LED blinks in red. The present alarm can be checked by counting the number of times the LED blinks. The motor puts into a non-excitation state. Also, the SON-MON output and the ALM-B output are turned OFF, and the ALM-A output is turned ON.

When an electromagnetic brake motor is used, the electromagnetic brake actuates to hold the motor shaft. If the alarm is reset, the driver transitions to the "Motor non-excitation" status.

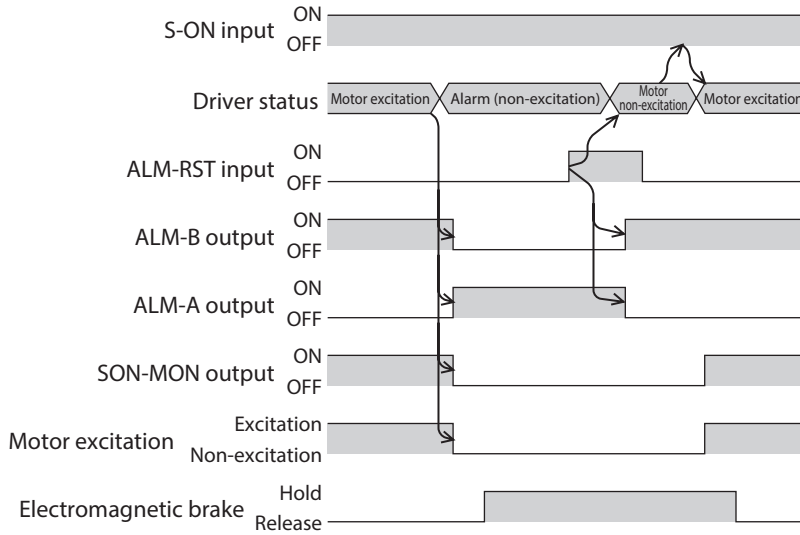

memo Refer to p.432 for details about alarms.

■ Power removal with ETO

If the driver detects both the HWTO1 and HWTO2 inputs are turned OFF, it transitions to the "Power removal with ETO" status.

The PWR/SYS LED blinks in white.

The motor puts into a non-excitation state. Also, the SON-MON output is turned OFF and the ETO-MON output is turned ON.

When an electromagnetic brake motor is used, the electromagnetic brake actuates to hold the motor shaft.

If both the HWTO1 and HWTO2 inputs are turned ON, the driver transitions to the "ETO" status.

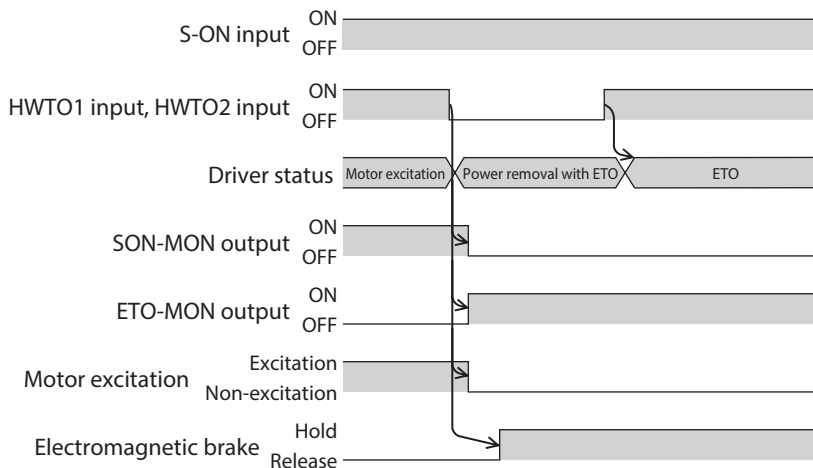

memo Refer to p.208 for the power removal function.

■ ETO

If both the HWT01 and HWT02 inputs are turned ON in a state where the driver is in the "Power removal with ETO" status, the driver transitions to the "ETO" status.

The PWR/SYS LED continues to blink in white.

The motor remains in a non-excitation state. Also, the SON-MON output is continued in an OFF state, and the ETO-MON output is continued in an ON state.

When an electromagnetic brake motor is used, the electromagnetic brake continues to hold the motor shaft.

If the ETO-CLR input is turned ON to release the "ETO" status, the driver transitions to the "Motor non-excitation" status.

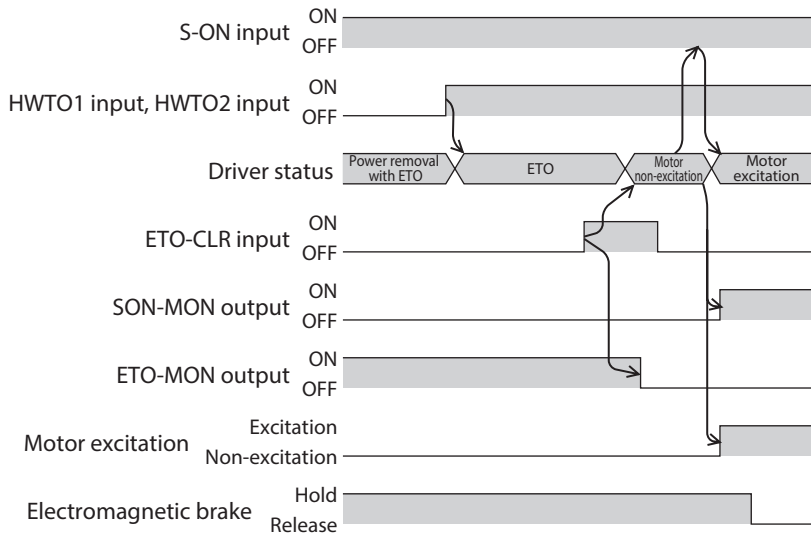

Related parameters

Parameter name	Description	Initial setting	
		Initial value	Unit
ETO reset ineffective period	Sets the time from when the driver transitions to the ETO status until it can release the ETO status. [Setting range] 0 to 100 ms	0	ms
ETO reset action (ETO-CLR)	Sets the judgment criterion of the signal when the ETO status is released by the ETO-CLR input. [Setting range] 1: ON edge (Positive edge) 2: ON level	1	-
ETO reset action (ALM-RST)	Enables to release the ETO status by the ALM-RST input. [Setting range] 0: Disable 1: ON edge (Positive edge)	0	-
ETO reset action (S-ON)	Enables to release the ETO status by the S-ON input. [Setting range] 0: Disable 1: ON edge (Positive edge)	1	-
ETO reset action (STOP)	Enables to release the ETO status by the STOP input. [Setting range] 0: Disable 1: ON edge (Positive edge)	1	-

- **"ETO reset ineffective period" parameter**

The motor cannot be excited even if the ETO-CLR input is turned from OFF to ON until the time set in the "ETO reset ineffective period" parameter is elapsed.

When the ETO-CLR input is turned ON before the time set in the "ETO reset ineffective period" parameter is elapsed (when the motor is excited at the ON edge of the input)

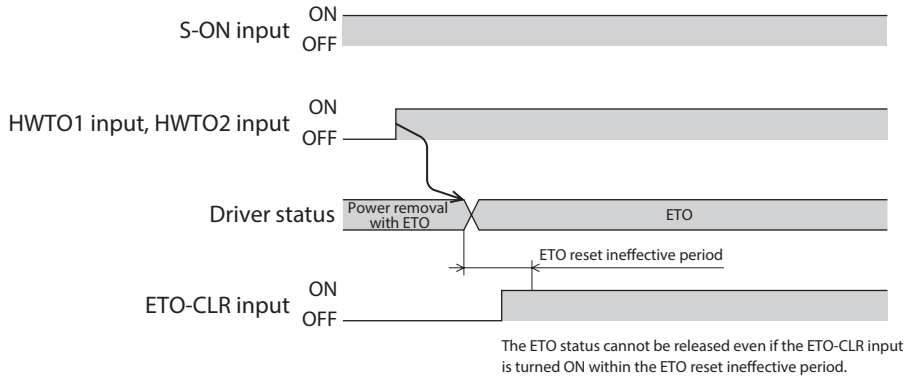

When the ETO-CLR input is turned ON after the setting time of the "ETO reset ineffective period" parameter is elapsed (when the motor is excited at the ON edge of the input)

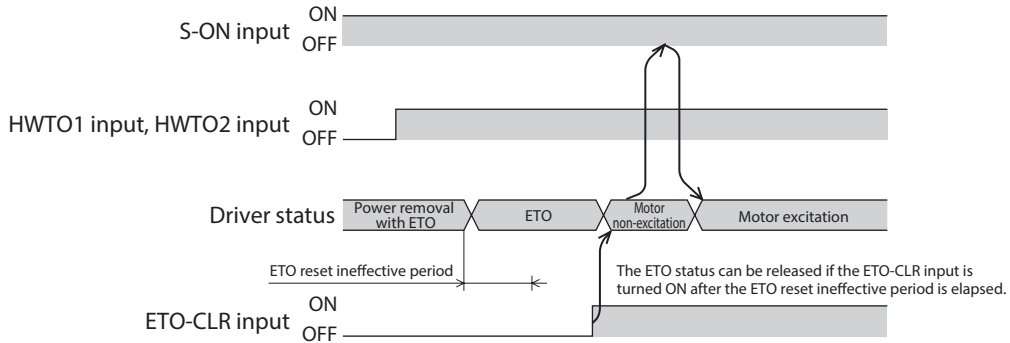

- **To release the "ETO" status by input signals other than ETO-CLR input**

The function to release the "ETO" status can be added to the ALM-RST input, the S-ON input, and the STOP input using parameters.

As the initial value, the function to release the "ETO" status is set to the S-ON input and the STOP input.

6-2 Driver status (motor excitation status)

Motor excitation

If the S-ON input is turned ON in a state where the driver is in the "Motor non-excitation" status, the driver transitions to the "Motor excitation" status.

The PWR/SYS LED remains in white light.

The motor puts into an excitation state. Also, the SON-MON output is turned ON.

When an electromagnetic brake motor is used, the electromagnetic brake is released.

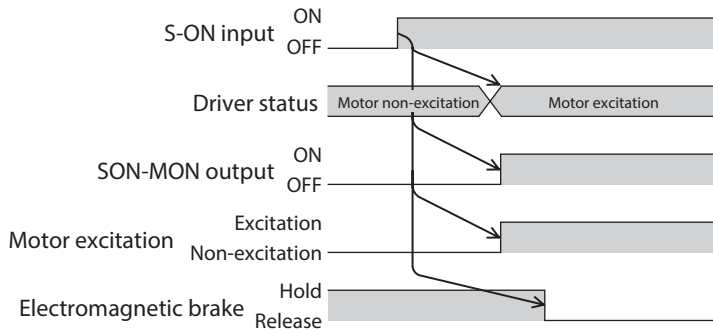

Note The motor can be operated only when the driver status is in the "Motor excitation" status.

Alarm (excitation)

If the driver detects an alarm that allows the motor to keep an excitation state, the driver transitions to the "Alarm (excitation)" status.

The PWR/SYS LED blinks in red. The present alarm can be checked by counting the number of times the LED blinks.

The motor remains in an excitation state. Also, the ALM-B output is turned OFF and the ALM-A output is turned ON.

When an electromagnetic brake motor is used, the electromagnetic brake is released.

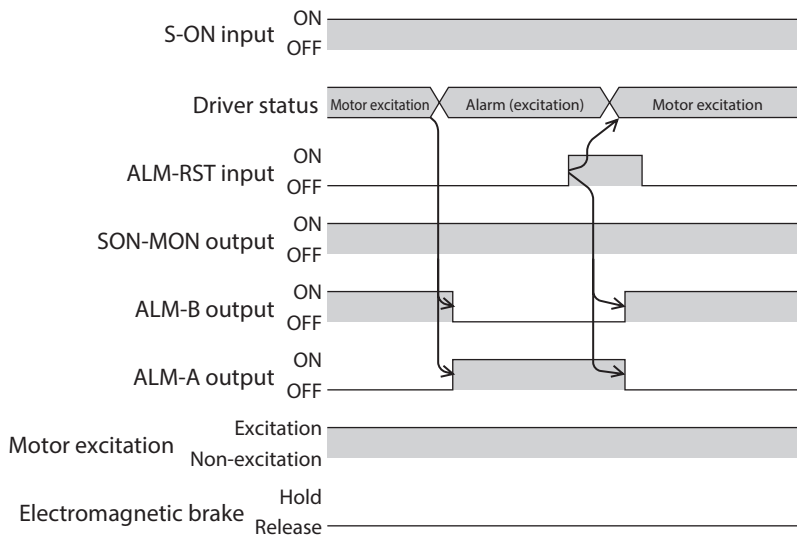

memo Refer to p.432 for details about alarms.

2 Operating method

◆ Table of contents

1	Flow of settings necessary for operation	50	6	FW/RV operation	112
2	Operation overview	51	6-1	Types of FW/RV operation	112
3	Operation types.....	52	6-2	JOG operation	114
3-1	Types of operation.....	52	6-3	High-speed JOG operation.....	116
3-2	Operation methods and operation types	55	6-4	Inching operation	118
3-3	Setting method of target position.....	60	6-5	Continuous operation (position control)	120
3-4	Selecting the operation type.....	63	6-6	Continuous operation (speed control).....	123
3-5	Operation type and position loop	64	6-7	Continuous operation (push-motion)	126
3-6	Motion extension mode.....	66	7	I/O homing operation	129
3-7	Continuous operation (cyclic speed control).....	67	7-1	3-sensor mode	133
4	Direct data operation	68	7-2	2-sensor mode	136
4-1	Guidance	69	7-3	One-way rotation mode	138
4-2	Command necessary for direct data operation	75	7-4	Push-motion mode	140
4-3	Trigger and lifetime.....	78	8	Extended function	142
4-4	Data destination.....	81	8-1	Acceleration/deceleration setting method	142
4-5	Transfer of operation data	82	8-2	Accept stored data override operation start by START input	143
4-6	Operation example when operation data was overridden	83	8-3	Automatic S-ON for the FW/RV operation	145
4-7	Timing chart.....	85			
5	Stored data operation	86			
5-1	Types of stored data (SD) operation.....	86			
5-2	Setting the data	87			
5-3	Operation I/O event	91			
5-4	Operation data number selection	92			
5-5	Operating method and timing chart	94			
5-6	Link method of operation data	96			
5-7	Sequence function	106			

1 Flow of settings necessary for operation

Details of  are described in this part.

2 Operating method

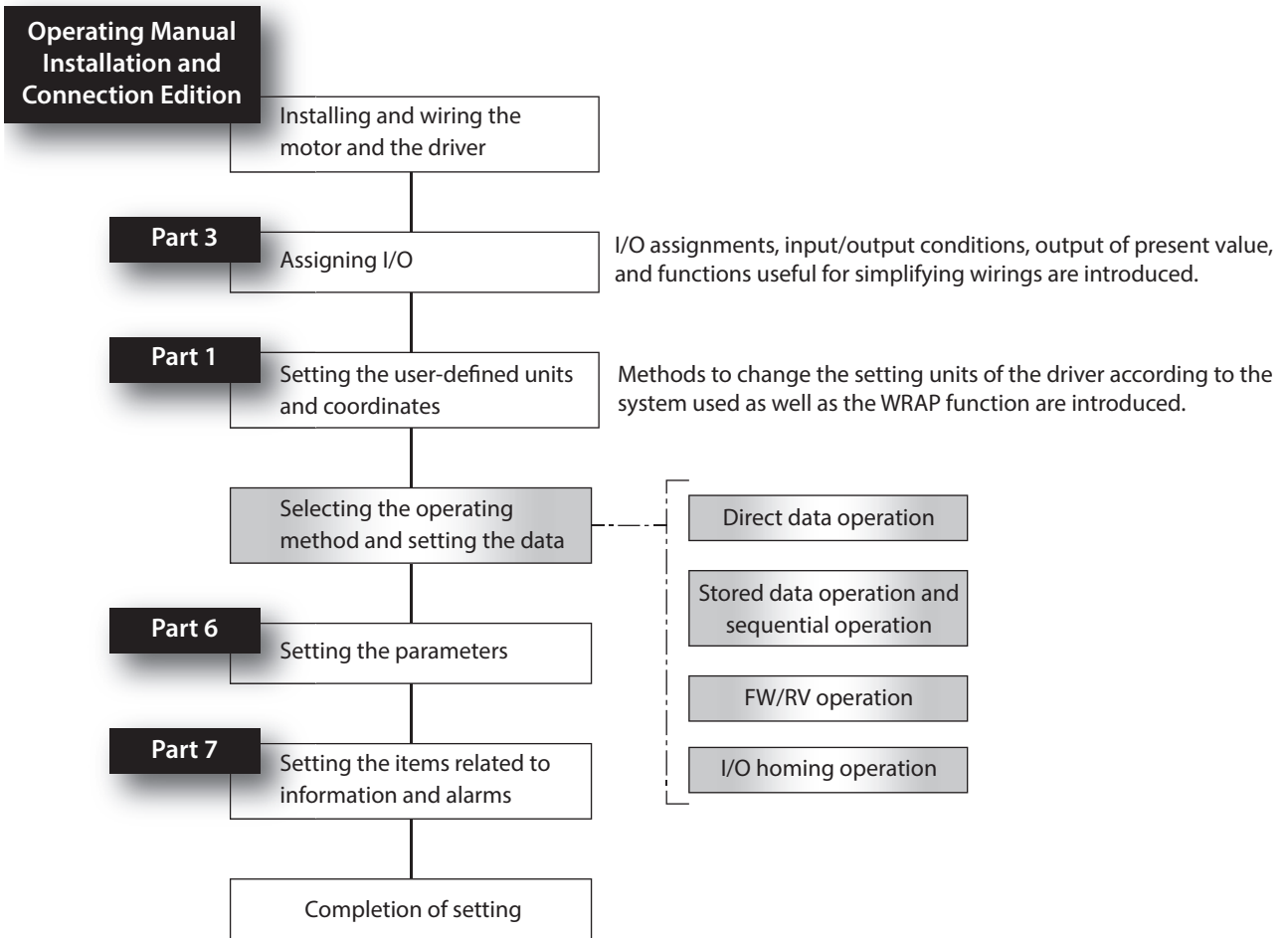

2 Operation overview

■ Direct data operation

Direct data operation is a method that allows overriding of data and start of operation to be executed at the same time.

It is suitable to frequently change operation data such as the position (travel amount) and velocity or to adjust the position finely.

■ Stored data operation

Stored data operation is an operation that sets the operation data such as the motor operating velocity and position (travel amount) and executes.

Up to 256 operation data (No.0 to No.255) can be set.

■ FW/RV operation

FW/RV operation is an operating method that turns a specific input signal ON to execute an operation corresponding to the signal.

FW/RV operation includes JOG operation, inching operation, and continuous operation.

■ I/O homing operation

Homing operation is an operation that detects the home using external sensors.

It is executed to return from the present position to the home when the power supply is turned on or positioning operation is completed.

■ Operation via CAN communication (drive profile)

Item	Description
Operation mode	The following modes are supported. <ul style="list-style-type: none"> • Profile position mode (pp) • Profile velocity mode (pv) • Homing mode (hm)

3 Operation types

3-1 Types of operation

2 Operating method

Type of operation method	Description	
Stop operation	This is used to stop the operation presently performed.	
	Operation type	Description
	Deceleration rate stop (according to the specified operation profile)	The motor decelerates to a stop according to the operation profile specified.
	Deceleration rate stop (according to the operation profile in during operation)	The motor decelerates to a stop according to the operation profile being operated.
	Immediate stop	The motor stops immediately.
Continuous operation	The motor starts rotating at the starting velocity and accelerates until it reaches the operating velocity. Once it reaches the operating velocity, the velocity is kept constant and the operation is continued.	
	Operation type	Description
	Continuous operation (position control)	The motor starts rotating at the starting velocity and accelerates until it reaches the operating velocity. Once it reaches the operating velocity, the operation is continued with the velocity maintained while monitoring the position deviation.
	Continuous operation (speed control)	The motor starts rotating at the starting velocity and accelerates until it reaches the operating velocity. Once it reaches the operating velocity, the operation is continued with the velocity maintained.
	Continuous operation (cyclic speed control) *3	The motor starts rotating at the starting velocity and accelerates until it reaches the operating velocity. Once it reaches the operating velocity, the operation is continued with the velocity maintained. This is an operation type suitable for applications where the velocity is changed at a certain period in direct data operation.
	Continuous operation (push-motion) *1	The motor starts rotating at the starting velocity and accelerates until it reaches the operating velocity. Once it reaches the operating velocity, the operation is continued with the velocity maintained. When a mechanism installed to the motor presses against a load, pressure is continuously applied to the load. Set the torque limiting value to 100.0% or less. *2
	Continuous operation (torque control) *1	The motor starts rotating at the operating velocity and continues the operation with the velocity maintained. When a mechanism installed to the motor presses against a load, pressure is continuously applied to the load. Set the torque limiting value to 100.0% or less. *2

Type of operation method	Description	
Positioning operation	Operation with trapezoidal drive (drive with acceleration/deceleration time) is performed from the present position to the target position. The motor starts rotating at the starting velocity and accelerates until it reaches the operating velocity. Once it reaches the operating velocity, the velocity is kept constant. Then, it decelerates when the stop position is approached, and finally comes to a stop. The position loop is enabled when operation is started.	
Setting method of target position	Operation type	Description
Absolute positioning	Absolute positioning	Positioning operation is performed from the present position to the set target position.
Incremental positioning	Incremental positioning (based on demand position)	Positioning operation with the set travel amount is performed from the present demand position.
	Incremental positioning (based on actual position)	Positioning operation with the set travel amount is performed from the present actual position.
	Incremental positioning (based on target position)	Positioning operation with the set travel amount is performed from the present target position.
WRAP absolute positioning	WRAP absolute positioning	Positioning operation is performed to the target position within the WRAP range.
	WRAP proximity positioning	Positioning operation in the shortest distance is performed to the target position within the WRAP range.
	WRAP absolute positioning (FWD)	Positioning operation in the forward direction (FWD) is performed to the target position within the WRAP range.
	WRAP absolute positioning (RVS)	Positioning operation in the reverse direction (RVS) is performed to the target position within the WRAP range.
Positioning operation (speed control)	Operation with trapezoidal drive (drive with acceleration/deceleration time) is performed from the present position to the target position. The motor starts rotating at the starting velocity and accelerates until it reaches the operating velocity. Once it reaches the operating velocity, the velocity is kept constant. Then, it decelerates when the stop position is approached, and finally comes to a stop. If a load exceeding the torque limiting value is applied, a slip occurs to turn the SLIP output ON.	
Setting method of target position	Operation type	Description
Incremental positioning	Incremental positioning (based on demand position)	Positioning operation (speed control) with the set travel amount is performed from the present demand position.
	Incremental positioning (based on actual position)	Positioning operation (speed control) with the set travel amount is performed from the present actual position.

Type of operation method	Description	
Positioning push-motion operation *1	Operation with trapezoidal drive (drive with acceleration/deceleration time) is performed from the present position to the target position. The motor starts rotating at the starting velocity and accelerates until it reaches the operating velocity. Once it reaches the operating velocity, the velocity is kept constant. Then, it decelerates when the stop position is approached, and finally comes to a stop. Using the TLC output as the completion signal for push-motion operation can judge whether a mechanism installed to the motor presses against a load. Set the torque limiting value to 100.0% or less. *2	
Setting method of target position	Operation type	Description
Absolute positioning	Absolute positioning push-motion	Positioning push-motion operation is performed from the present position to the set target position.
	Incremental positioning push-motion (based on demand position)	Positioning push-motion operation with the set travel amount is performed from the present demand position.
Incremental positioning	Incremental positioning push-motion (based on actual position)	Positioning push-motion operation with the set travel amount is performed from the present actual position.
	Incremental positioning push-motion (based on target position)	Positioning push-motion operation with the set travel amount is performed from the present target position.
	WRAP absolute push-motion	Positioning push-motion operation is performed to the target position within the WRAP range.
WRAP absolute positioning	WRAP proximity push-motion	Positioning push-motion operation is performed in the shortest distance to the target position within the WRAP range.
	WRAP push-motion (FWD)	Positioning push-motion operation in the forward direction (FWD) is performed to the target position within the WRAP range.
	WRAP push-motion (RVS)	Positioning push-motion operation in the forward direction (RVS) is performed to the target position within the WRAP range.

*1 When combined with a gear, do not perform operation that continues pressing to a load.

*2 If a value larger than 100.0% is set to the torque limiting value, an alarm of "Operation data error" is generated.

*3 It is effective for the driver version 3.00 or later.



- To operate the motor, turn the S-ON input ON to put the motor into an excitation state.
- When combined with a gear, set the "Starting velocity" parameter so that the motor shaft speed is 300 r/min or lower.

3-2 Operation methods and operation types

There are five types of operation methods as shown below.

Note To operate the motor, turn the S-ON input ON to put the motor into an excitation state.

■ Stop operation

This is used to stop the operation presently performed.

- Deceleration rate stop (according to the specified operation profile)

[Operation profile]

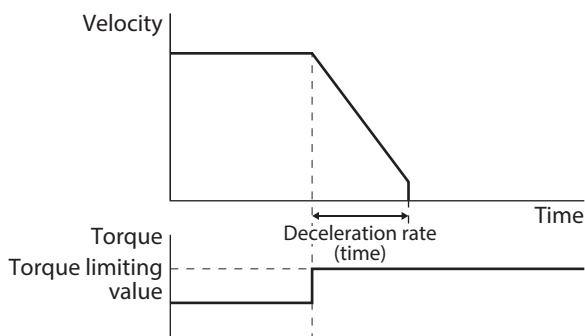

- Deceleration rate stop (according to the operation profile in during operation)

[Operation profile]

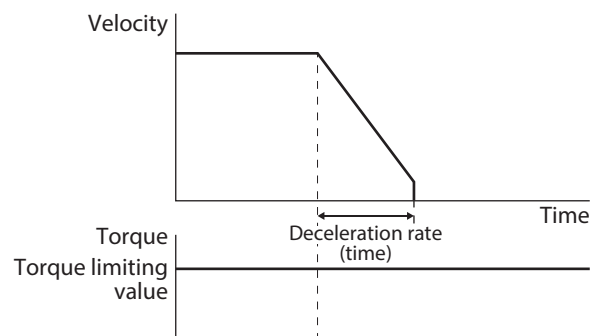

- Immediate stop

[Operation profile]

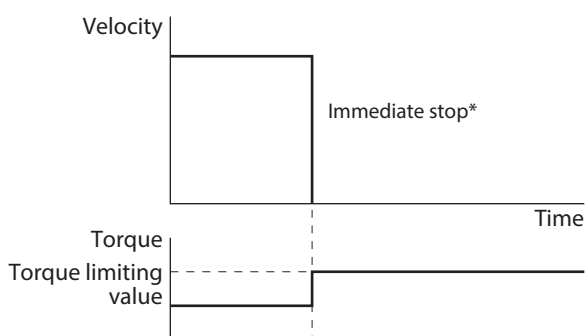

* The motor decelerates at the maximum deceleration rate.

memo When stop operation is executed, the target position is not updated.

■ **Continuous operation**

The motor starts rotating at the starting velocity and accelerates until it reaches the operating velocity. Once it reaches the operating velocity, the velocity is kept constant and the operation is continued.

Setting a positive value to the operating velocity continues to operate the motor at a constant velocity in the forward direction (FWD), and setting a negative value continues to operate it at a constant velocity in the reverse direction (RVS).

- **Continuous operation (position control), continuous operation (speed control), continuous operation (push-motion), Continuous operation (cyclic speed control)**

- **Continuous operation (torque control)**

[Operation profile]

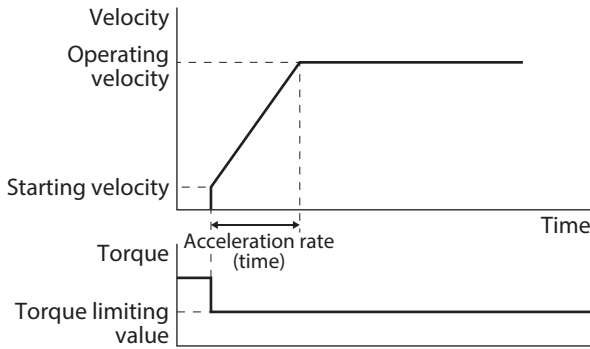

[Operation profile]

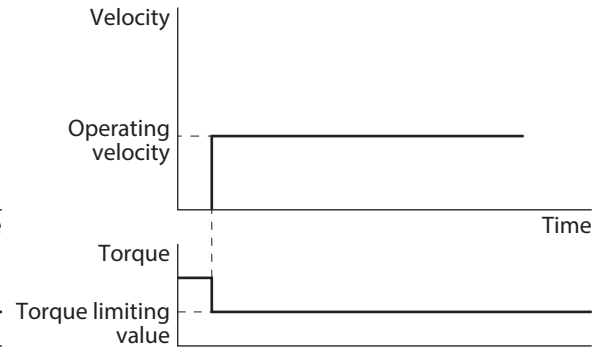

When continuous operation is executed, the target position is not updated.



When combined with a gear, do not perform continuous operation (push-motion) and continuous operation (torque control).

■ Positioning operation

Operation with trapezoidal drive (drive with acceleration/deceleration time) is performed from the present position to the target position. The motor starts rotating at the starting velocity and accelerates until it reaches the operating velocity.

Once it reaches the operating velocity, the velocity is kept constant. Then, it decelerates when the stop position is approached, and finally comes to a stop.

- **Absolute positioning, incremental positioning (based on demand position), incremental positioning (based on actual position), incremental positioning (based on target position), WRAP absolute positioning, WRAP proximity positioning, WRAP absolute positioning (FWD), WRAP absolute positioning (RVS)**

[Operation profile]

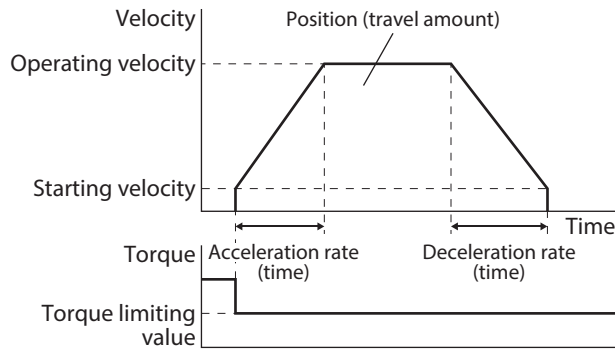

The maximum travel amount of positioning operation is 2,147,483,647 steps. If the travel amount of the motor exceeds the maximum travel amount, an alarm of "Operation data error" will be generated.



- The rotation direction of positioning operation is determined based on the setting of "Position."
 - Absolute positioning: Operates in the forward direction (FWD) when "Position" is larger than the present position, and in the reverse direction (RVS) when "Position" is smaller than the present position.
 - Incremental positioning: Operates in the forward direction (FWD) when a positive value is set, and in the reverse direction (RVS) when a negative value is set.
- Operation when a negative value is set to the operating velocity is shown below.
 - Absolute positioning: Operates as the velocity of the absolute value.
 - Incremental positioning: Operates in the forward direction (FWD) when a negative value is set to "Position," and in the reverse direction (RVS) when a positive value is set.

■ **Positioning operation (speed control)**

Operation with trapezoidal drive (drive with acceleration/deceleration time) is performed from the present position to the target position. The motor starts rotating at the starting velocity and accelerates until it reaches the operating velocity.

Once it reaches the operating velocity, the velocity is kept constant. Then, it decelerates when the stop position is approached, and finally comes to a stop.

If a load exceeding the torque limiting value is applied, a slip occurs to turn the SLIP output ON.

- **Incremental positioning speed control (based on demand position),**
incremental positioning speed control (based on actual position)

[Operation profile]

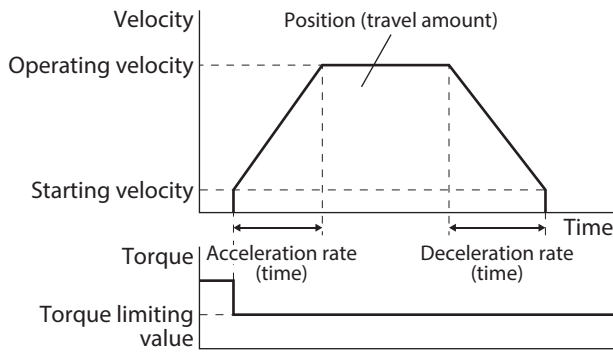

The maximum travel amount of positioning operation is 2,147,483,647 steps. If the travel amount of the motor exceeds the maximum travel amount, an alarm of "Operation data error" will be generated.



- The rotation direction of positioning operation is determined based on the setting of "Position." Setting a positive value rotates the motor in the forward direction (FWD), and setting a negative value rotates it in the reverse direction (RVS).
- Operation when a negative value is set to the operating velocity is shown below.
Absolute positioning: Operates as the velocity of the absolute value.
Incremental positioning: Operates in the forward direction (FWD) when a negative value is set to "Position," and in the reverse direction (RVS) when a positive value is set.

■ Positioning push-motion operation

Operation with trapezoidal drive (drive with acceleration/deceleration time) is performed from the present position to the target position. The motor starts rotating at the starting velocity and accelerates until it reaches the operating velocity. Once it reaches the operating velocity, the velocity is kept constant. Then, it decelerates when the stop position is approached, and finally comes to a stop. Using the TLC output as the completion signal for push-motion operation can judge whether a mechanism installed to the motor presses against a load.

- **Absolute positioning push-motion, incremental positioning push-motion (based on demand position), incremental positioning push-motion (based on actual position), incremental positioning push-motion (based on target position), WRAP absolute push-motion, WRAP proximity push-motion, WRAP absolute push-motion (FWD), WRAP absolute push-motion (RVS)**

[Operation profile]

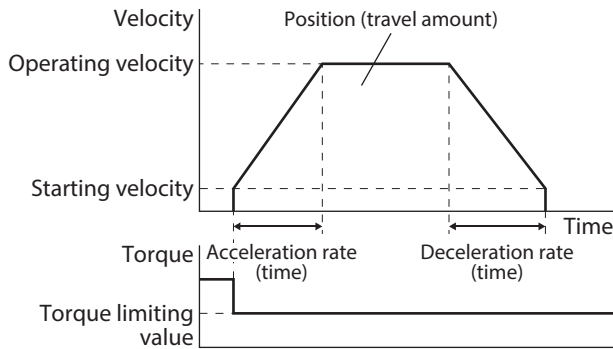

Note

- The maximum travel amount of positioning push-motion operation is 2,147,483,647 steps. If the travel amount of the motor exceeds the maximum travel amount, an alarm of "Operation data error" will be generated.
- When combined with a gear, do not perform positioning push-motion operation.
- If the motor moves to the position deviation alarm zone by an external force, an alarm of "Position deviation" will be generated.

Setting value in "Position deviation alarm" parameter

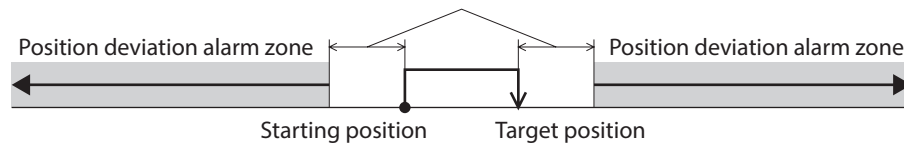

memo

- The rotation direction of positioning operation is determined based on the setting of "Position."
 Absolute positioning: Operates in the forward direction (FWD) when "Position" is larger than the present position, and in the reverse direction (RVS) when "Position" is smaller than the present position.
 Incremental positioning: Operates in the forward direction (FWD) when a positive value is set, and in the reverse direction (RVS) when a negative value is set.
- Operation when a negative value is set to the operating velocity is shown below.
 Absolute positioning: Operates as the velocity of absolute value.
 Incremental positioning: Operates in the forward direction (FWD) when a negative value is set to "Position," and in the reverse direction (RVS) when a positive value is set.

3-3 Setting method of target position

There are three types of setting methods for the target position as shown below.

■ Absolute positioning

Set the target position on coordinates with the home as a reference.

Example: Setting when moving from the present position "100" to the target position "400"

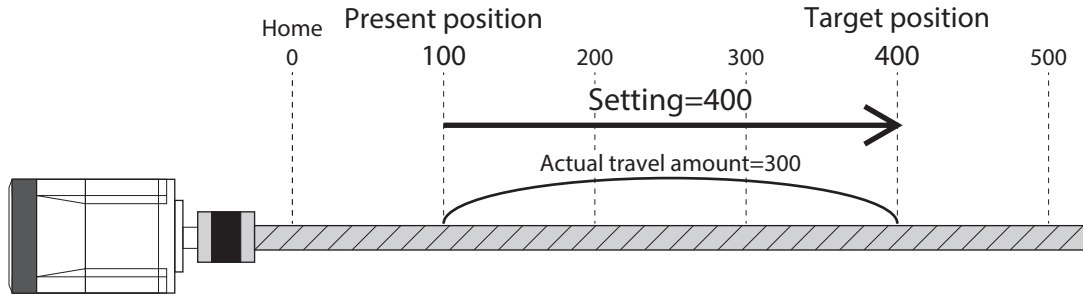

■ Incremental positioning

Set the position, which was moved by the set travel amount from the present position, as the target position. This is suitable when the same travel amount is repeatedly operated.

Example: Setting when moving from the present position "100" to the target position "400"

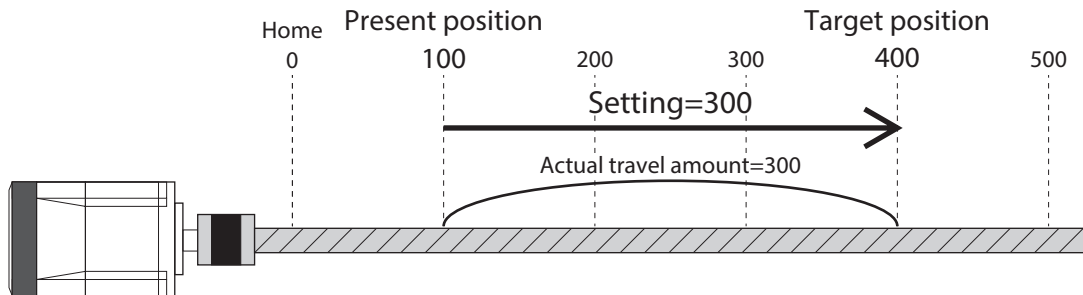

- memo** Based on demand position: Positioning operation is performed based on the present demand position.
- Based on actual position: Positioning operation is performed based on the present actual position.
- Based on target position: Positioning operation is performed based on the present target position.

■ WRAP absolute positioning

This is used by setting the "WRAP setting" parameters to "Follows WRAP setting lower limit/WRAP setting upper limit." Set the target position within the WRAP range.

Example: Setting when moving from the present position "100" to the target position "400"

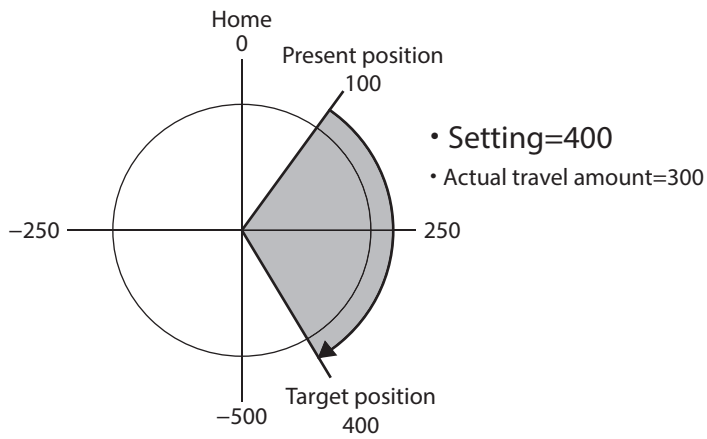

■ Orbit comparison of positioning operation

Movements when the following is set are shown below.

Item	Setting
WRAP setting	2: Follows WRAP setting lower limit/WRAP setting upper limit
WRAP setting lower limit	-500
WRAP setting upper limit	499

Operation type	From initial value (250) to a value set in "Position" of operation data	
	250 to 900	250 to -1400
<ul style="list-style-type: none"> ● Absolute positioning <p>※ Sets coordinates of the target position from the home.</p>		
<ul style="list-style-type: none"> ● Incremental positioning (based on demand position) ● Incremental positioning (based on actual position) ● Incremental positioning (based on target position) <p>※ Sets the travel amount from the demand position, actual position, or the present target position to the next target position.</p>		
<ul style="list-style-type: none"> ● WRAP absolute positioning <p>※ Sets the target position on coordinates with the home as a reference and operates within the WRAP range.</p>		
<ul style="list-style-type: none"> ● WRAP proximity positioning <p>※ Sets the target position on coordinates with the home as a reference and operates to the target position within the WRAP range in the shortest distance.</p>		
<ul style="list-style-type: none"> ● WRAP absolute positioning (FWD) <p>※ Sets the target position on coordinates with the home as a reference and operates in the forward direction (FWD) toward the target position within the WRAP range.</p>		
<ul style="list-style-type: none"> ● WRAP absolute positioning (RVS) <p>※ Sets the target position on coordinates with the home as a reference and operates in the reverse direction (RVS) toward the target position within the WRAP range.</p>		

* The value in □ represents the coordinate of the position where the motor stopped.

3-4 Selecting the operation type

The table below show a list of operation types that can be selected in direct data operation or stored data operation. Use the "Direct data operation operation type" command and the "Operation data R/W" command to set.

Setting value		Operation types
Motion extension mode	Normal	
0 (00h)	–	Deceleration rate stop (according to the specified operation profile)
–	1 (01h)	Absolute positioning
–	2 (02h)	Incremental positioning (based on demand position)
–	3 (03h)	Incremental positioning (based on actual position)
–	4 (04h)	Incremental positioning (based on target position)
–	5 (05h)	Incremental positioning speed control (based on demand position)
–	6 (06h)	Incremental positioning speed control (based on actual position)
39 (27h)	7 (07h)	Continuous operation (position control)
–	8 (08h)	Wrap absolute positioning
–	9 (09h)	Wrap proximity positioning
–	10 (0Ah)	Wrap absolute positioning (FWD)
–	11 (0Bh)	Wrap absolute positioning (RVS)
–	12 (0Ch)	Wrap absolute push-motion
–	13 (0Dh)	Wrap proximity push-motion
–	14 (0Eh)	Wrap push-motion (FWD)
–	15 (0Fh)	Wrap push-motion (RVS)
48 (30h)	16 (10h)	Continuous operation (speed control)
49 (31h)	17 (11h)	Continuous operation (push-motion)
50 (32h)	18 (12h)	Continuous operation (torque control)
51 (33h)	19 (13h)	Continuous operation (cyclic speed control)
–	20 (14h)	Absolute positioning push-motion
–	21 (15h)	Incremental positioning push-motion (based on demand position)
–	22 (16h)	Incremental positioning push-motion (based on actual position)
–	23 (17h)	Incremental positioning push-motion (based on target position)
31 (1Fh)	–	Deceleration rate stop (according to the operation profile during operation)
32 (20h)	–	Immediate stop



- Refer to p.66 for the motion extension mode.
- The Motion extension mode and continuous operation (cyclic speed control) are effective for the driver version 3.00 or later.



Note When combining a 400 W motor with a gear, use the motion extension mode. When the 400 W motor with a gear is used in a normal state, the motor may be damaged if it rapidly decelerates while the demand velocity is significantly different from the actual velocity.

3-5 Operation type and position loop

The table below shows operation types that the position loop is enabled.

Direct data operation Stored data operation		FW/RV operation	Drive profile	Operation types	Position loop
Operation types setting value		Input signal (□: FW or RV)	Operation mode		
Motion extension mode	Normal				
0 (00h)	–	–	–	Deceleration rate stop (according to the specified operation profile)	*1
–	1 (01h)	–	pp	Absolute positioning	Enabled
–	2 (02h)	□-JOG-P	pp	Incremental positioning (based on demand position)	Enabled
–	3 (03h)	–	pp	Incremental positioning (based on actual position)	Enabled
–	4 (04h)	–	pp	Incremental positioning (based on target position)	Enabled
–	5 (05h)	–	pv	Incremental positioning speed control (based on demand position)	–
–	6 (06h)	–	pv	Incremental positioning speed control (based on actual position)	–
39 (27h)	7 (07h)	□-POS	pv	Continuous operation (position control)	Enabled
–	8 (08h)	–	pp	Wrap absolute positioning	Enabled
–	9 (09h)	–	pp	Wrap proximity positioning	Enabled
–	10 (0Ah)	–	pp	Wrap absolute positioning (FWD)	Enabled
–	11 (0Bh)	–	pp	Wrap absolute positioning (RVS)	Enabled
–	12 (0Ch)	–	pp	Wrap absolute push-motion	*2
–	13 (0Dh)	–	pp	Wrap proximity push-motion	*2
–	14 (0Eh)	–	pp	Wrap push-motion (FWD)	*2
–	15 (0Fh)	–	pp	Wrap push-motion (RVS)	*2
48 (30h)	16 (10h)	□-SPD □-JOG □-JOG-H	pv	Continuous operation (speed control)	–
49 (31h)	17 (11h)	□-PSH	–	Continuous operation (push-motion)	–
50 (32h)	18 (12h)	–	–	Continuous operation (torque control)	–
51 (33h)	19 (13h)	–	–	Continuous operation (cyclic speed control)	–
–	20 (14h)	–	pp	Absolute positioning push-motion	*2
–	21 (15h)	–	pp	Incremental positioning push-motion (based on demand position)	*2
–	22 (16h)	–	pp	Incremental positioning push-motion (based on actual position)	*2
–	23 (17h)	–	pp	Incremental positioning push-motion (based on target position)	*2
31 (1Fh)	–	–	–	Deceleration rate stop (according to the operation profile during operation)	*1
32 (20h)	–	–	–	Immediate stop	*1

*1 A state of the position loop is based on the operation type before starting stop operation.

*2 In positioning push-motion operation, the position loop is enabled only for the following time period when operation is stopped.

1 ms or less or the setting time of the drive-complete delay time



-
- The position loop at stopping is switched by the PLOOP-MODE input.
To control the position in a state where position deviation or slip is not occurred, always turn the PLOOP-MODE input ON.
 - The position loop is enabled when the motor is in an excitation state.
 - The position loop is enabled in homing operation. (Except the push-motion mode)
-

3-6 Motion extension mode

The motion extension mode is a control mode in which the driver generates the demand velocity with the "actual velocity" as the starting point when the velocity is changed. When the actual velocity does not follow the demand velocity, the motor can quickly respond without waiting that the demand velocity becomes equal to the actual velocity.

In the following cases, the driver generates the demand velocity with the "actual velocity" as the starting point.

- When decelerating to the target velocity lower than the actual velocity while accelerating in a state where the demand velocity is higher than actual velocity
- When accelerating to the target velocity higher than the actual velocity while decelerating in a state where the demand velocity is lower than actual velocity

If the actual velocity has already exceeded the target velocity when the velocity is started changing, the demand velocity will immediately be a value of the target velocity.

The motion extension mode can be selected with the following methods.

- Select with the operation type in the case of direct data operation or stored data operation.
- Select with the "FW/RV operation control mode setting" parameter in the case of FW/RV operation.
- Select with the Controlword in the case of the drive profile (CAN communication).

If the motion extension mode is not selected (in the case of a normal state), the driver generates the demand velocity with the "demand velocity" as the starting point.

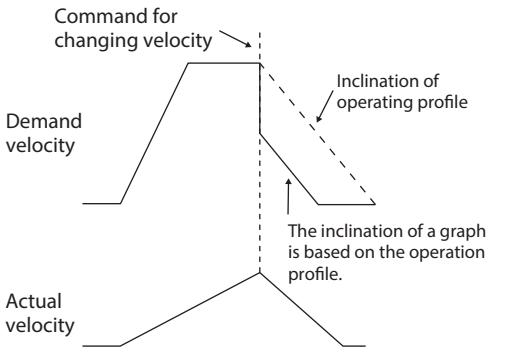
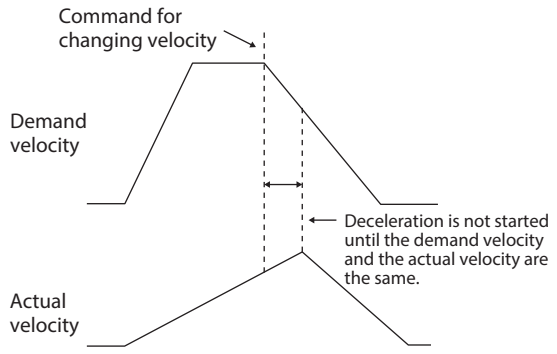
Control mode	Motion extension mode	Normal
Example of operation	<p>When the velocity is changed, the demand velocity is generated with the "actual velocity" as the starting point.</p> 	<p>When the velocity is changed, the demand velocity is generated with the "demand velocity" as the starting point.</p> 
Feature	<ul style="list-style-type: none"> • The motor can quickly respond according to the actual velocity. • The time period required for changing the velocity may be shorter than the acceleration/ deceleration time set in the operation profile. 	<ul style="list-style-type: none"> • The demand velocity is generated according to the setting of the operation profile.
Recommended application	<ul style="list-style-type: none"> • When the velocity is frequently changed during operation • When the actual velocity does not follow the demand velocity because the load inertia is large 	<ul style="list-style-type: none"> • When a predetermined operation is repeatedly performed

- memo**
- Even in the operation type in a normal state, operation in the motion extension mode is applied when stopped by stop operation or an operation stop signal.
 - The motion extension mode is effective for the driver version 3.00 or later.

- Note**
- When combining a 400 W motor with a gear, use the motion extension mode. When the 400 W motor with a gear is used in a normal state, the motor may be damaged if it rapidly decelerates while the demand velocity is significantly different from the actual velocity.

3-7 Continuous operation (cyclic speed control)

Continuous operation (cyclic speed control) is an operation type suitable for applications where the velocity is changed at a certain period in direct data operation.

The acceleration/deceleration rate (acceleration/deceleration time) in this operation type changes as shown below.

- Acceleration rate (acceleration time) → Changing speed rate (changing speed time)
- Deceleration rate (deceleration time) → Stopping rate (stopping time)

When changing the rotation direction, the changing speed rate (changing speed time) is applied to reach the target velocity after reversing.

Example of operation: When changing the velocity at a certain period

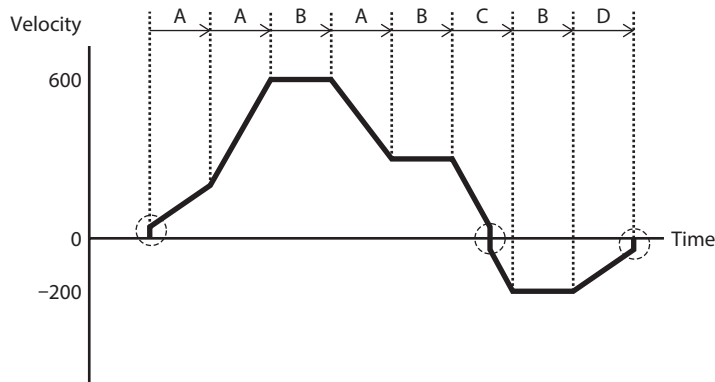

A: Acceleration or deceleration at changing speed rate (changing speed time)

B: No velocity change

C: Reverse operation at changing speed rate (changing speed time)

D: Deceleration stop at stopping rate (stopping time)

○: Starting velocity



- "Acceleration/deceleration setting method" parameter is not applied.
- Continuous operation (cyclic speed control) is effective for the driver version 3.00 or later.

4 Direct data operation

Direct data operation is a method that allows overriding of data and start of operation to be executed at the same time.

It is suitable to frequently change operation data such as the position (travel amount) and velocity or to adjust the position finely.

Triggers to start operation at the same time as overriding of data are as follows.

- One of the following items: Operation data number, operation type, position, operating velocity, acceleration rate, deceleration rate, and torque limiting value
- The above seven items are collectively overridden

■ Application example of direct data operation

● Example 1

The position (travel amount) or the operating velocity should be adjusted each time a load is changed because the feed rate is different in each load.

Setting example

- Position (travel amount): Change as desired
- Operating velocity: Change as desired
- Trigger: All the items (setting value of trigger: 1)

Procedure

1. Write the position and the operating velocity.
2. Write "1" to the trigger.

Result

When the trigger is written, the changed value is updated immediately, and operation is performed with the new position and the operating velocity.

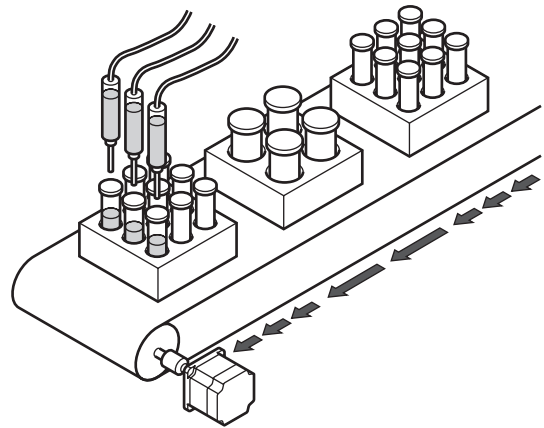

● Example 2

The operating velocity should be changed immediately with the touch screen because a large load is inspected at a lower rate.

Setting example

- Operating velocity: Change as desired
- Trigger: Operating velocity (setting value of trigger: -4)

Procedure

1. Write "-4" to the trigger.
2. Write the data of the operating velocity.

Result

If the operating velocity is written, the changed value is updated immediately, and the operation is performed at the new operating velocity.

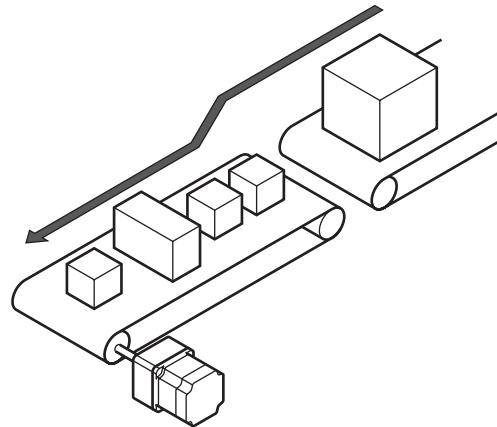

Note To operate the motor, turn the S-ON input ON to put the motor into an excitation state.

4-1 Guidance

If you are new to this product, read this section to understand the operating methods along with the operation flow.

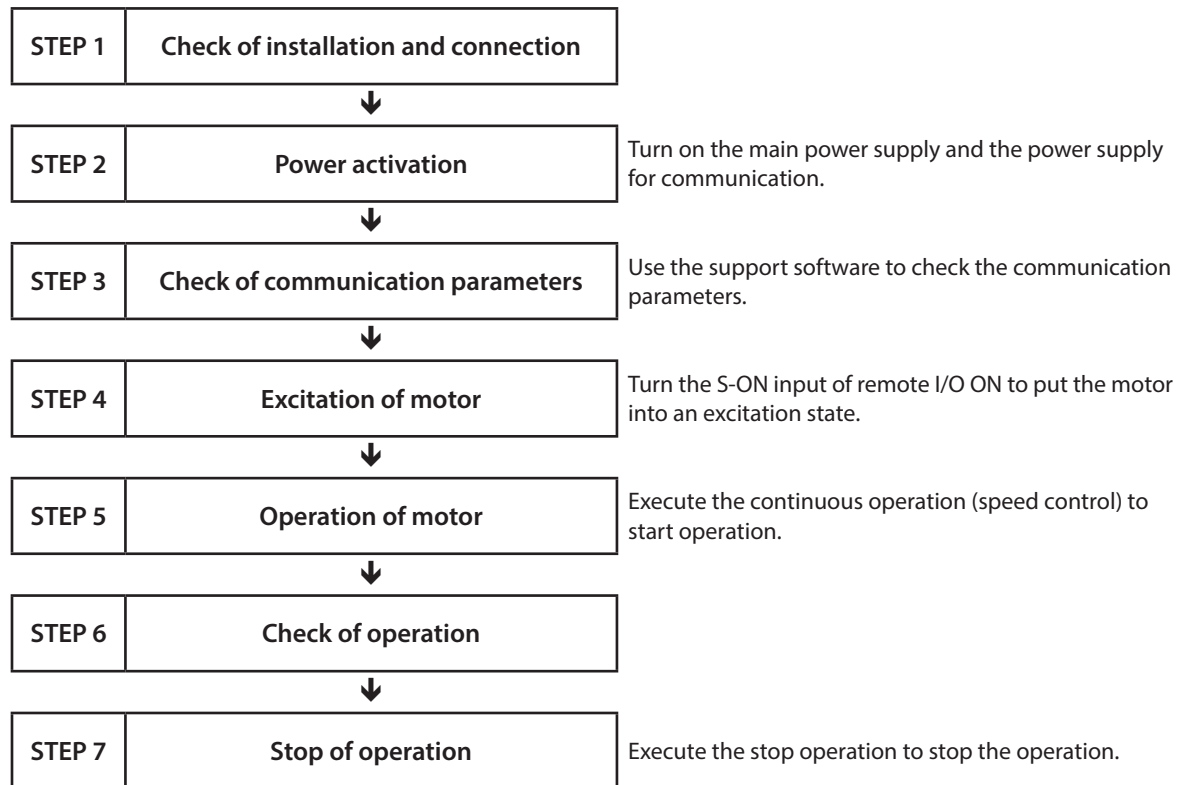

● Operating conditions

This operation is performed under the following conditions.

- Number of drivers connected: 1 unit
- Address number: 1
- Transmission rate: 230,400 bps
- Termination resistor: Set to enable



Before operating the motor, check the surrounding conditions to ensure safety.

STEP 1 Check of installation and connection

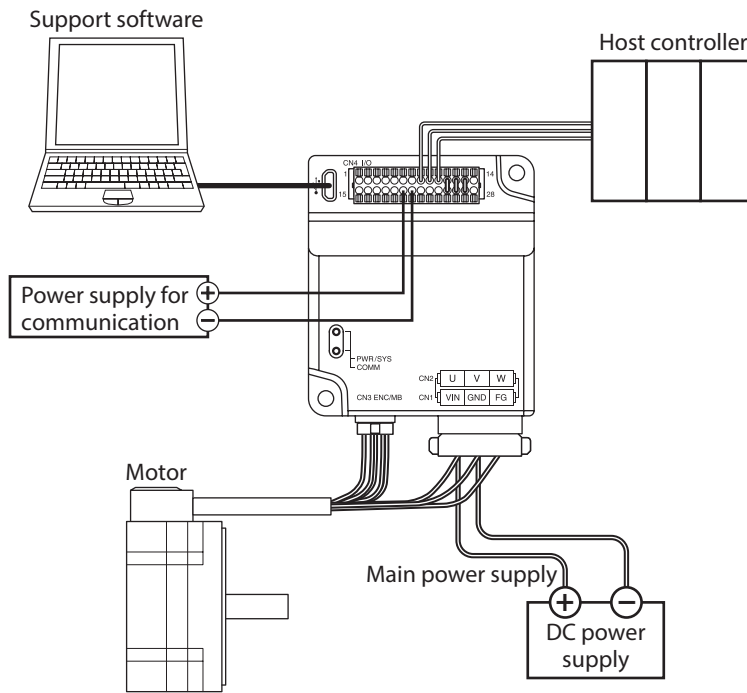

STEP 2 Power activation

- Turn on the main power supply and the power supply for communication.
- Start the support software.
- Execute "Communication port" to check the setting of the communication port.
- Execute "Data reading" to read the driver data.

STEP 3 Check of communication parameters

Start "Starts the simple setting." of the support software.

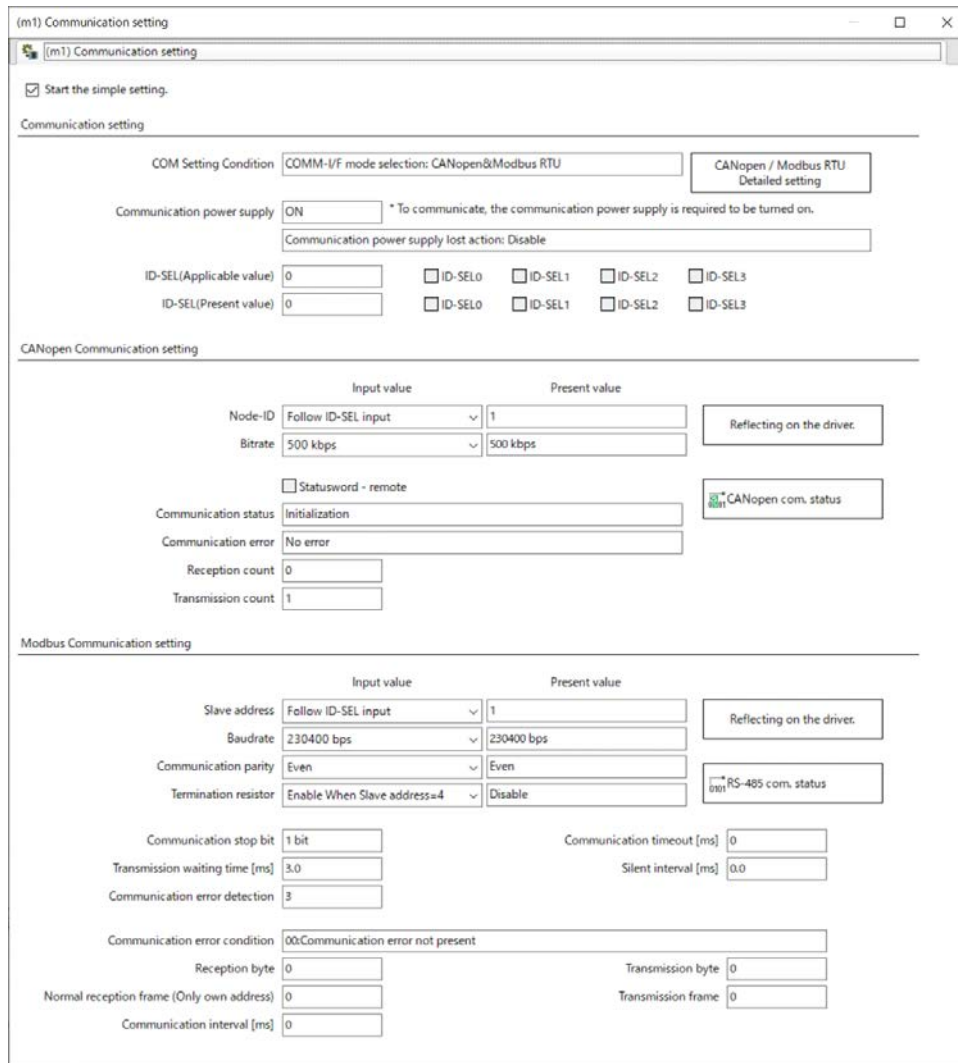

Set the following communication parameters according to the communication parameters of the host controller.

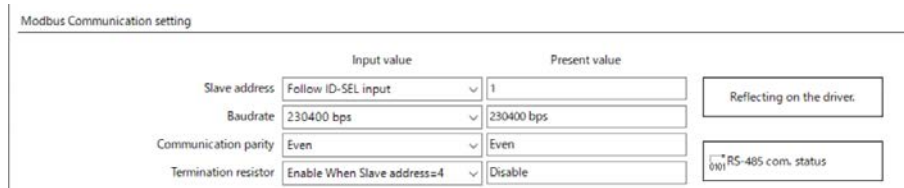

If the values are different, change the value of the "Input value" and execute "Reflecting on the driver."

If the following communication parameters are different from those of the host controller, execute "Detailed setting..." to change the parameters.

Parameter name	Setting
Byte & word order (Modbus)	Even Address-High Word & Big-Endian
Communication stop bit (Modbus)	1 bit

STEP 4 Excitation of motor

Send the following query to turn the S-ON input of remote I/O ON.
 Turning the S-ON input ON causes the motor to put into an excitation state.

01 10 00 7C 00 02 04 00 00 00 01 35 1E
 ① ② ③ ④ ⑤ ⑥ ⑦ ⑧

Number	Communication data (HEX)	Description
①	01	Address number=1
②	10	Function code=10h
③	00 7C	Write register lead address=007Ch
④	00 02	Number of write registers=2 registers
⑤	04	Number of write data bytes=4 bytes
⑥	00 00 00 01	Turn the S-ON input ON (put the motor into an excitation state)
⑦	35	Error check (lower)
⑧	1E	Error check (upper)

STEP 5 Operation of motor

As an example, this section explains how to execute the following operation. The trigger is assumed to be overridden collectively.

[Operation profile]

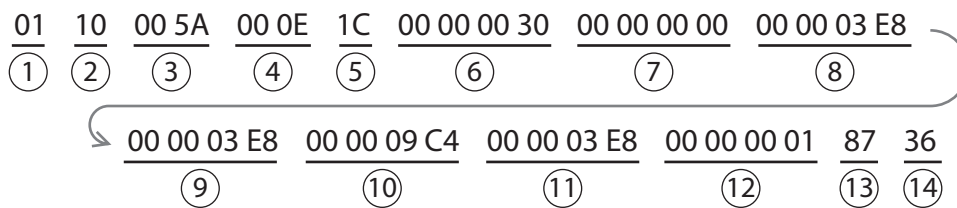
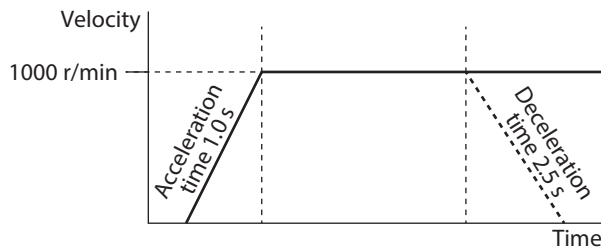

1. Send the operation data and the trigger with the following query. Operation is started at the same time as the send.

Number	Communication data (HEX)	Description
①	01	Address number=1
②	10	Function code=10h
③	00 5A	Write register lead address=005Ah
④	00 0E	Number of write registers=14 registers
⑤	1C	Number of write data bytes=28 bytes
⑥	00 00 00 30	Operation type=48: (Motion extension) continuous operation (speed control)
⑦	00 00 00 00	Position=0 step
⑧	00 00 03 E8	Operating velocity=1000 r/min
⑨	00 00 03 E8	Acceleration rate=1,000 ms
⑩	00 00 09 C4	Deceleration rate=2,500 ms
⑪	00 00 03 E8	Torque limiting value=100.0%
⑫	00 00 00 01	Trigger=1: Normal start, Lifetime disable
⑬	87	Error check (lower)
⑭	36	Error check (upper)

Setting of operation profile

2. Check the motor rotates without any problem.



Note When combining a 400 W motor with a gear, use the motion extension mode. When the 400 W motor with a gear is used in a normal state, the motor may be damaged if it rapidly decelerates while the demand velocity is significantly different from the actual velocity.

STEP 6 Check of operation

How did it go? Were you able to operate the motor properly? If the motor does not operate, check the following points.

- Is any alarm present?
- Are the power supply, the motor, and the RS-485 communication cable connected securely?
- Is the power supply for communication turned on?
- Are the slave addresses, the transmission rate, and the termination resistor set correctly?
- Is the COMM LED unlit? Or is it lit in red? (A communication error occurs)
- Is an unintended input signal is turned ON?

STEP 7 Stop of operation

1. Send the operation data and the trigger with the following query. Operation is stopped at the same time as the send.

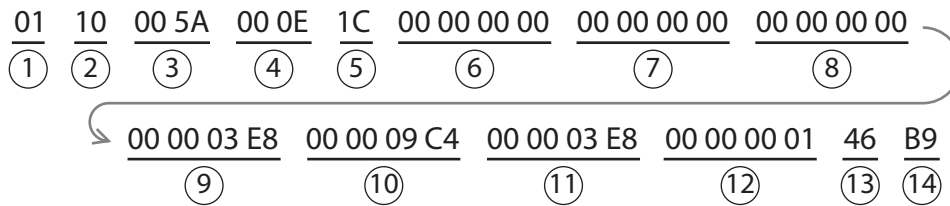

Number	Communication data (HEX)	Description
①	01	Address number=1
②	10	Function code=10h
③	00 5A	Write register lead address=005Ah
④	00 0E	Number of write registers=14 registers
⑤	1C	Number of write data bytes=28 bytes
⑥	00 00 00 00	Operation type=0: Deceleration rate stop (according to the specified operation profile)
⑦	00 00 00 00	Position=0 step
⑧	00 00 00 00	Operating velocity=0 r/min
⑨	00 00 03 E8	Acceleration rate=1,000 ms
⑩	00 00 09 C4	Deceleration rate=2,500 ms
⑪	00 00 03 E8	Torque limiting value=100.0%
⑫	00 00 00 01	Trigger=1: Normal start, Lifetime disable
⑬	46	Error check (lower)
⑭	B9	Error check (upper)

2. Check the motor stops without any problem.

4-2 Command necessary for direct data operation

Register address		Name	Description	Initial setting	
Upper	Lower			Initial value	Unit
88 (0058h)	89 (0059h)	Direct data operation operation data number	<p>The operation data of the specified operation data number is transferred to the direct data operation command.</p> <p>Writing a value of the operation data number executes the data transfer.</p> <p>Commands to be transferred are as follows.</p> <ul style="list-style-type: none"> • Direct data operation operation type • Direct data operation position • Direct data operation operating velocity • Direct data operation acceleration rate • Direct data operation deceleration rate • Direct data operation torque limiting value <p>[Setting range] 0 to 255: Operation data No.0 to No.255</p>	0 *1	–
90 (005Ah)	91 (005Bh)	Direct data operation operation type	<p>Sets the operation type for direct data operation.</p> <p>[Setting range] Refer to "3-4 Selecting the operation type" on p.63.</p>	0 *2	–
92 (005Ch)	93 (005Dh)	Direct data operation position	<p>Sets the target position for direct data operation.</p> <p>[Setting range] –2,147,483,648 to 2,147,483,647 (User-defined position unit)</p>	0 *2	step
94 (005Eh)	95 (005Fh)	Direct data operation operating velocity	<p>Sets the operating velocity for direct data operation.</p> <p>[Setting range] –4,000,000 to 4,000,000 (User-defined velocity unit)</p>	0 *2	r/min
96 (0060h)	97 (0061h)	Direct data operation acceleration rate	<p>Sets the acceleration rate (acceleration time) for direct data operation.</p> <p>[Setting range] 1 to 1,000,000,000 (User-defined acceleration/deceleration unit)</p>	1,000 *2	ms
98 (0062h)	99 (0063h)	Direct data operation deceleration rate	<p>Sets the deceleration rate (deceleration time) for direct data operation.</p> <p>[Setting range] 1 to 1,000,000,000 (User-defined acceleration/deceleration unit)</p>	1,000 *2	ms
100 (0064h)	101 (0065h)	Direct data operation torque limiting value	<p>Sets the torque limiting value for direct data operation.</p> <p>[Setting range] 0 to 10,000 (1=0.1%) *3</p>	10,000 *2	1=0.1%

Register address		Name	Description	Initial setting	
Upper	Lower			Initial value	Unit
102 (0066h)	103 (0067h)	Direct data operation trigger	Sets the trigger and the lifetime for direct data operation. [Setting range] <Upper 16 bits> Lifetime setting *4 -1, 0: Direct data operation lifetime disable 1 to 32767: Direct data operation lifetime setting value [ms] <Lower 16 bits> Trigger setting -7: Operation data number -6: Operation type -5: Position -4: Operating velocity -3: Acceleration rate -2: Deceleration rate -1: Torque limiting value 0: Disable 1 to 3: Normal start 4, 5: Unit specified start (acceleration/deceleration: rate) 6, 7: Unit specified start (acceleration/deceleration: time) 8, 9: Unit specified start (velocity: step/s) 10, 11: Unit specified start (velocity: step/s, acceleration/deceleration: rate) 12, 13: Unit specified start (velocity: step/s, acceleration/deceleration: time) 14, 15: Unit specified start (velocity: r/min) 16, 17: Unit specified start (velocity: r/min, acceleration/deceleration: rate) 18, 19: Unit specified start (velocity: r/min, acceleration/deceleration: time)	0	–
104 (0068h)	105 (0069h)	Direct data operation forwarding destination	Selects the stored area when the next direct data is transferred during direct data operation. (Data destination ⇒ p.81) [Setting range] 0: Execution memory 1: Buffer memory	0	–

*1 The value set in the "Direct data operation operation parameter initial value reference data number" parameter will be the initial value.

*2 The operation data of the operation data number set in the "Direct data operation operation parameter initial value reference data number" parameter will be the initial value.

*3 The maximum torque limiting value varies depending on the motor. Refer to p.39 for the maximum value of each motor.

*4 It is effective for the driver version 3.00 or later.

■ Related parameters

Register address		Name	Description	Initial setting	
Upper	Lower			Initial value	Unit
544 (0220h)	545 (0221h)	Direct data operation zero speed command action	When "0" is written to the operating velocity, selects whether to decelerate the motor to a stop or to change only the velocity to "0" in an operating status. *1 [Setting range] 0: Deceleration stop command 1: Velocity zero command	0	–
546 (0222h)	547 (0223h)	Direct data operation trigger initial value	Sets the initial value of the trigger (lower 16 bits). [Setting range] –7: Operation data number update –6: Operation type update –5: Position update –4: Operating velocity update –3: Acceleration rate update –2: Deceleration rate update –1: Torque limiting value update 0: The trigger is used	0	–
548 (0224h)	549 (0225h)	Direct data operation data destination initial value	Sets the initial value of the data destination. [Setting range] 0: Execution memory 1: Buffer memory	0	–
550 (0226h)	551 (0227h)	Direct data operation operation parameter initial value reference data number	Sets the operation data number to be used as the initial value for direct data operation. [Setting range] 0 to 255: Operation data number	0	–
552 (0228h)	553 (0229h)	Direct data operation trigger automatic clear	Sets the movement when setting "Direct data operation trigger" which is set the trigger factor to transfer or update the data in the direct data operation memory area as execution data. When this parameter is set to enable, if direct data operation is started by writing to "Direct data operation trigger," the trigger (lower 16 bits) of "Direct data operation trigger" is automatically cleared to "0" regardless of whether it is successful or not. Therefore, if the same data is written, direct data operation can be started as many times as written. When this parameter is set to disable, "Direct data operation trigger" is not cleared to 0 even if it is written. Therefore, direct data operation is not started even if the same data is written in succession. To restart, one of the following is required. • Write "0" to "Direct data operation trigger" and then write the value for starting. • Write a different value to "Direct data operation trigger." [Setting range] 0: Disable 1: Enable	1	–
572 (023Ch)	573 (023Dh)	Direct data operation lifetime initial value *2	Sets the initial value for direct data operation lifetime. [Setting range] 0: Disable 1 to 32,767 ms	0	ms

*1 Although the motor does not rotate because the velocity is "0," the output signals are in an operating status.

*2 It is effective for the driver version 3.00 or later.

4-3 Trigger and lifetime

Sets the trigger and the lifetime for direct data operation.

Upper 16 bits: Direct data operation lifetime

Lower 16 bits: Trigger

Note If either the direct data operation lifetime or the trigger is out of the range, a communication error of "Out of setting range" occurs. In this case, both the upper and lower values are not applied.

■ Lower 16 bits Trigger

This is a trigger to start operation at the same time as overriding of data in direct data operation.

■ When the trigger setting is "0" to "19"

When the following value is written, all data is written in the selected unit, and simultaneously direct data operation is started. It is not started if the same value is written. If the "Direct data operation trigger automatic clear" parameter is set to "Enable," the trigger (lower 16 bits) will automatically return to "0" regardless of whether the operation is started or not (initial value: Enable).

xxxx: If the lifetime is not used, set 0000h or FFFFh.

Set the lifetime when using it.

Setting value		Starting mode	Starting method	
Dec *	Hex		Velocity unit	Acceleration/ deceleration unit
0	xxxx 0000h	Not start	—	—
1 (or 2, 3)	xxxx 0001h (xxxx 0002h) (xxxx 0003h)	Normal start	User-defined velocity unit	User-defined acceleration/ deceleration unit
4 (or 5)	xxxx 0004h (xxxx 0005h)	Unit specified start (acceleration/ deceleration)	User-defined velocity unit	(Velocity unit)/s (acceleration/ deceleration rate)
6 (or 7)	xxxx 0006h (xxxx 0007h)	Unit specified start (acceleration/ deceleration)	User-defined velocity unit	ms (acceleration/ deceleration time)
8 (or 9)	xxxx 0008h (xxxx 0009h)	Unit specified start (velocity)	step/s ((User-defined position unit)/s)	User-defined acceleration/ deceleration unit
10 (or 11)	xxxx 000Ah (xxxx 000Bh)	Unit specified start (velocity, acceleration/ deceleration)	step/s ((User-defined position unit)/s)	(Velocity unit)/s (acceleration/ deceleration rate)
12 (or 13)	xxxx 000Ch (xxxx 000Dh)	Unit specified start (velocity, acceleration/ deceleration)	step/s ((User-defined position unit)/s)	ms (acceleration/ deceleration time)
14 (or 15)	xxxx 000Eh (xxxx 000Fh)	Unit specified start (velocity)	r/min (motor shaft)	User-defined acceleration/ deceleration unit
16 (or 17)	xxxx 0010h (xxxx 0011h)	Unit specified start (velocity, acceleration/ deceleration)	r/min (motor shaft)	(Velocity unit)/s (acceleration/ deceleration rate)
18 (or 19)	xxxx 0012h (xxxx 0013h)	Unit specified start (velocity, acceleration/ deceleration)	r/min (motor shaft)	ms (acceleration/ deceleration time)

* This is the value when the lifetime is not used.

Note If the operation is started in a state where the setting value is "8" to "19" (Unit specified start (velocity) or Unit specified start (velocity, acceleration/deceleration)), the monitor unit of the target velocity will be the same as the specified unit only when the operation is being performed. Therefore, the target velocity is the value having commanded.

■ When the trigger setting is "-1" to "-7"

Direct data operation is started when the data corresponding to the trigger is written. Even if operation is started, the setting value of the trigger is retained.

xxxx: If the lifetime is not used, set 0000h or FFFFh.

Set the lifetime when using it.

Setting value		Starting mode	Starting method	
Dec *	Hex		Velocity unit	Acceleration/deceleration unit
-7	xxxx FFF9h	Start when writing operation data number	User-defined velocity unit	User-defined acceleration/deceleration unit
-6	xxxx FFFAh	Start when writing operation type	User-defined velocity unit	User-defined acceleration/deceleration unit
-5	xxxx FFFBh	Start when writing position	User-defined velocity unit	User-defined acceleration/deceleration unit
-4	xxxx FFFCh	Start when writing velocity	User-defined velocity unit	User-defined acceleration/deceleration unit
-3	xxxx FFFDh	Start when writing acceleration rate	User-defined velocity unit	User-defined acceleration/deceleration unit
-2	xxxx FFFEh	Start when writing deceleration rate	User-defined velocity unit	User-defined acceleration/deceleration unit
-1	xxxx FFFFh	Start when writing torque limiting value	User-defined velocity unit	User-defined acceleration/deceleration unit

* This is the value when the lifetime is not used.

■ Setting value of xxxx (setting value of lifetime)

Setting value		Direct data operation lifetime action	Description
Dec	Hex		
-32768	8000h	Out of setting range	The direct data operation lifetime is out of the setting range. The lifetime is continued counting while being counted.
•	•		
-2	FFFEh		
-1	FFFFh	Stop	The direct data operation lifetime is disabled. The lifetime is stopped counting when already counting.
0	0000h		
1	0001h	Start	The setting value will be the direct data operation lifetime [ms]. The lifetime is updated when already counting.
2	0002h		
•	•		
•	•		
32767	7FFFh		

■ Upper 16 bits Direct data operation lifetime

● Direct data operation lifetime

The lifetime for direct data operation can be set.

Use the lifetime when direct data operation is periodically executed.

If the lifetime is set, the timer inside the driver starts counting (countdown) when direct data operation is executed.

When the count value reaches "0," an alarm of "RS-485 communication timeout" is generated, and the motor stops.

The lifetime is updated when the direct data operation is executed.

It is not updated by other communication than direct data operation.

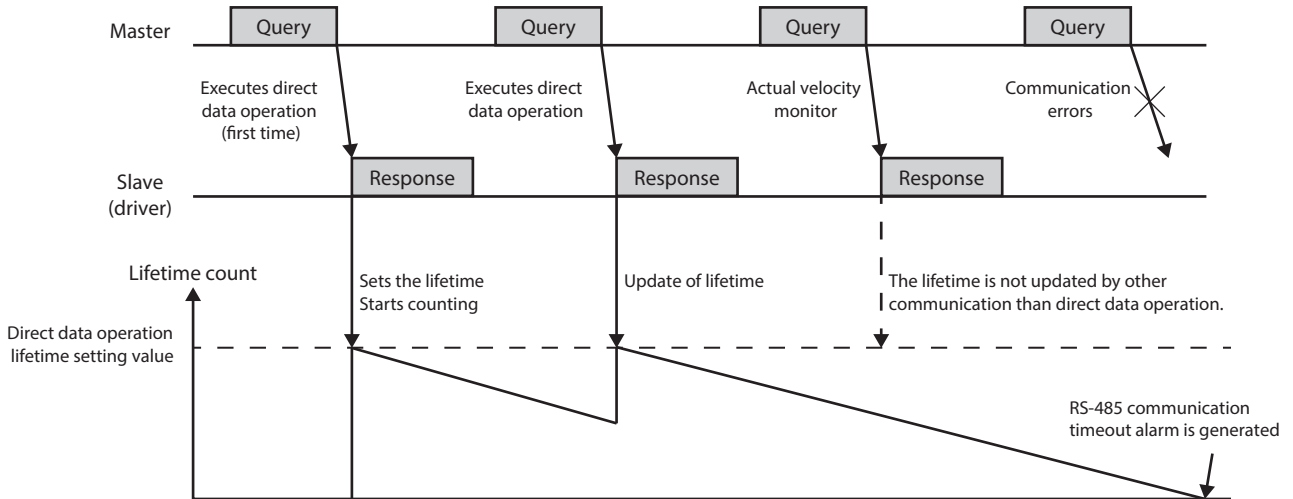

● Update of lifetime

The lifetime is stopped counting to set again.

The lifetime is updated at the following.

- When direct data operation is executed
- When the "Direct data operation trigger" command is written

4-4 Data destination

During direct data operation, the stored area when the next direct data is transferred can be selected.

Setting value		Data destination
Dec	Hex	
0	0000 0000h	Execution memory
1	0000 0001h	Buffer memory

■ When the data destination is set to "Execution memory"

When the trigger is written, the data in operation can be overridden to the next direct data.

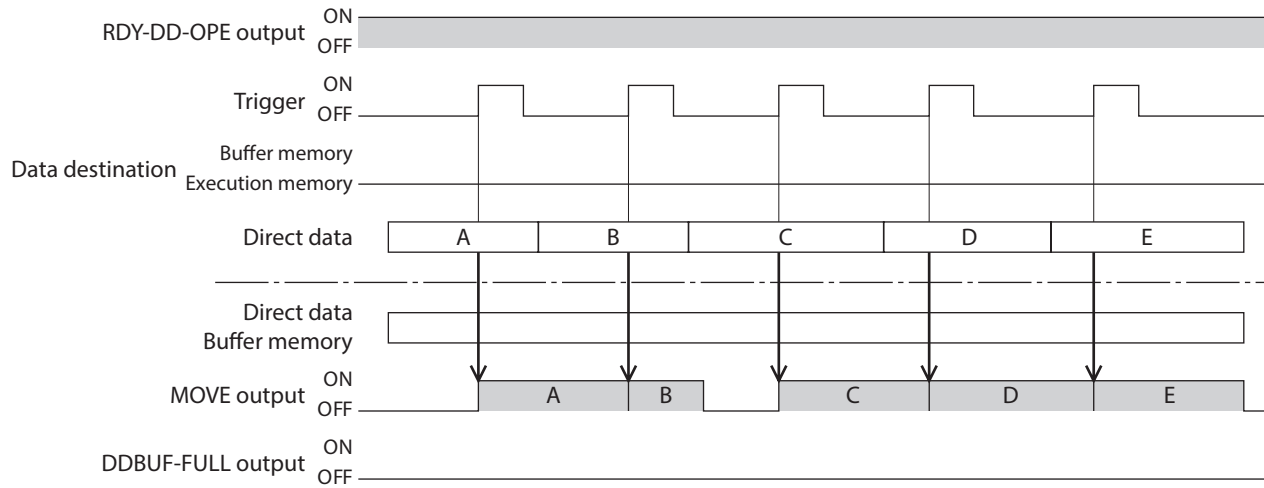

■ When the data destination is set to "Buffer memory"

If the trigger is written, the next direct data is stored in the buffer memory. When the data during operation is completed, operation of the buffer memory is automatically started. One direct data can be stored in the buffer memory. If the next direct data is written to the buffer memory, the DDBUF-FULL output is turned ON. During stop or continuous operation, if "Buffer memory" is specified, the data is not stored in the buffer memory and it is overridden to the next direct data immediately. In the following cases, even if "Buffer memory" is specified, the direct data is not stored in the buffer memory. It is rewritten to the next direct data immediately.

- When stopped (when operation is already ended)
- During continuous operation
- While instructing execution of stop operation

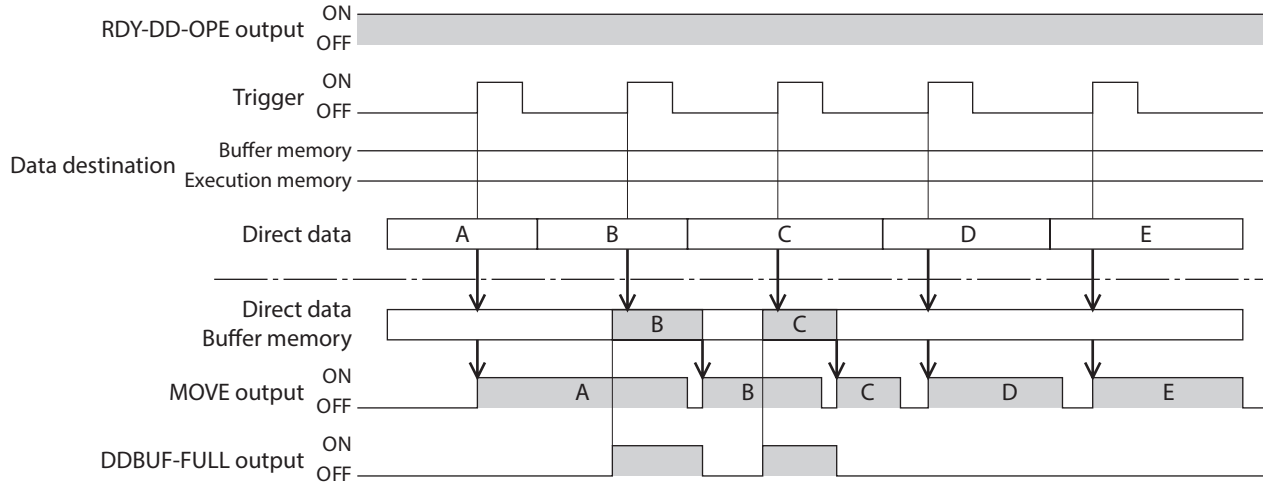

Note If the trigger is written in a state where the DDBUF-FULL output is ON, the following is applied.
 When the data destination is set to "Buffer memory": The direct data is not applied.
 When the data destination is set to "Execution memory": The written data is applied.
 The data in the buffer memory is cleared.

4-5 Transfer of operation data

The value is transferred from the operation data of the direct data operation operation data number to each command at the following time.

- When the main power supply is turned on or when Configuration is executed.
- When writing to the direct data operation operation data number is executed

Operation data (data source) and direct data operation command (data destination) are as follows.

Operation data (data source)	Direct data operation command (data destination)
Operation type	Direct data operation operation type
Position	Direct data operation position
Velocity	Direct data operation operating velocity
Acceleration rate / Acceleration time *	Direct data operation acceleration rate
Deceleration rate / Deceleration time *	Direct data operation deceleration rate
Torque limiting value	Direct data operation torque limiting value

* The operation data of the data source varies depending on the setting of the "User-defined acceleration/ deceleration unit setting (DD, FWRV, SD, HOME operation)" parameter.
 (User-defined velocity unit)/s: Acceleration rate and deceleration rate
 ms: Acceleration time and deceleration time

4-6 Operation example when operation data was overridden

This is operation when the data destination was set to "Execution memory" and the operation data was overridden (override).
 (Operation example)
 Operation when having overridden to the direct data operation 2 while the direct data operation 1 is executed

Example 1

Direct data operation 1: Continuous operation
 Direct data operation 2: Continuous operation

When operating velocity 2 is faster than operating velocity 1

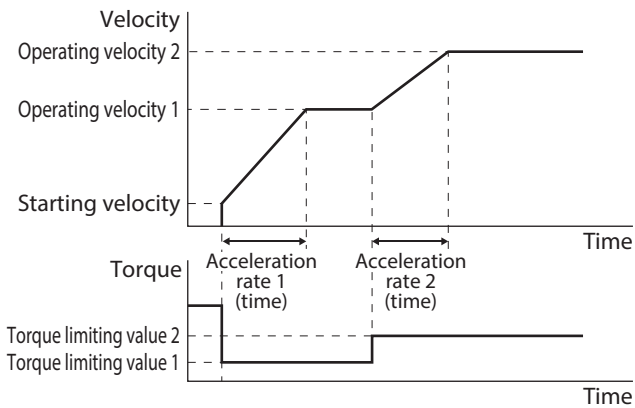

When operating velocity 1 is faster than operating velocity 2

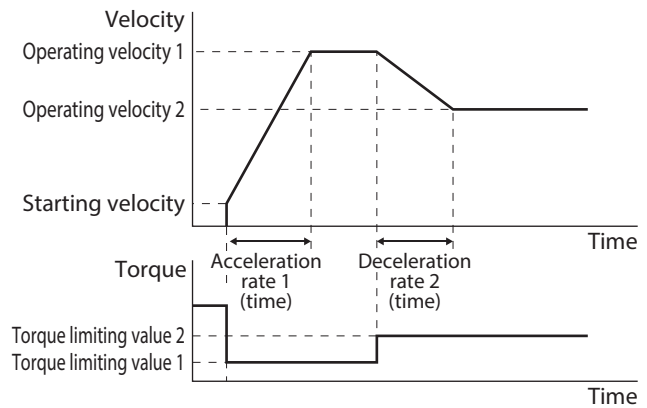

Example 2

Direct data operation 1: Positioning operation
 Direct data operation 2: Positioning operation

When operating velocity 2 is faster than operating velocity 1

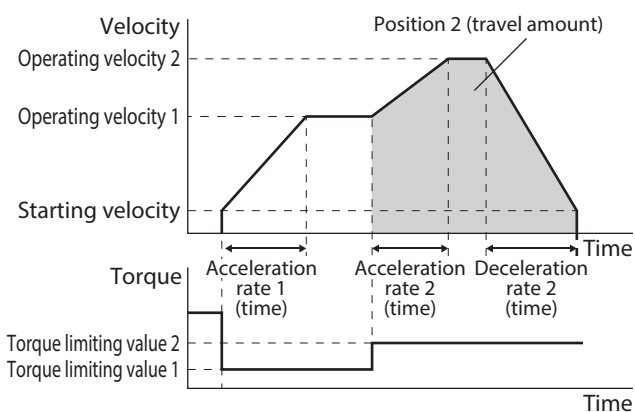

When operating velocity 1 is faster than operating velocity 2

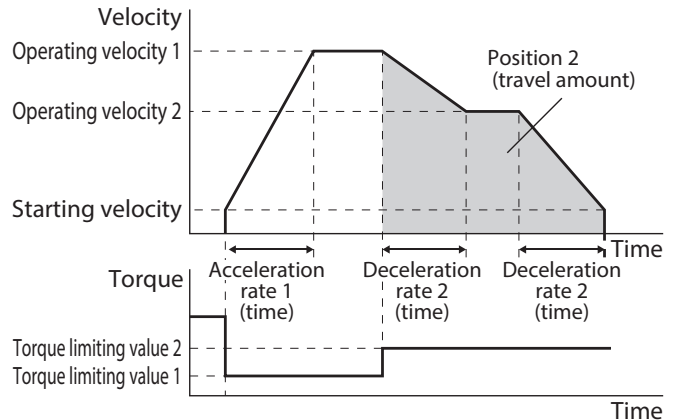

Example 3

Direct data operation 1: Continuous operation
 Direct data operation 2: Positioning operation

When operating velocity 2 is faster than operating velocity 1

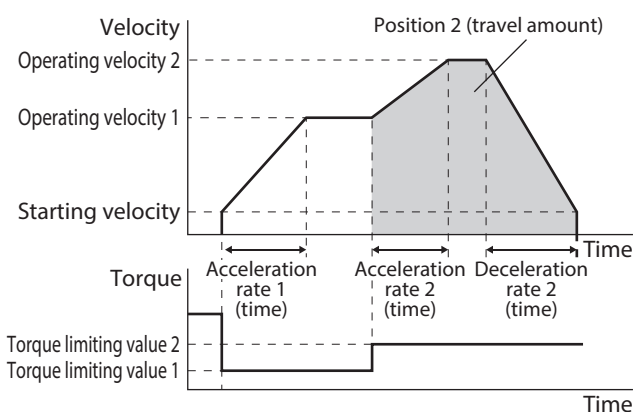

When operating velocity 1 is faster than operating velocity 2

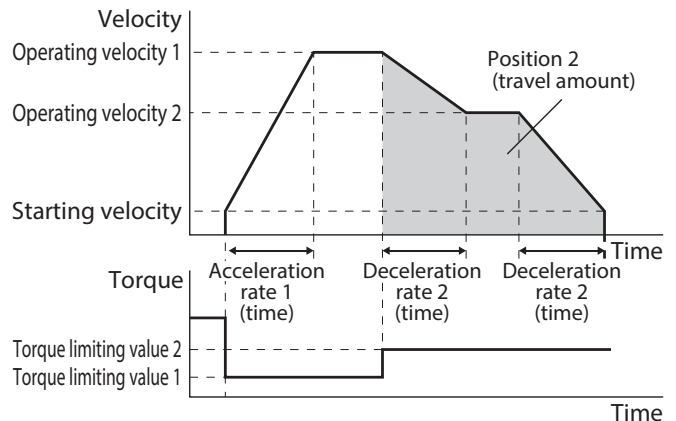

Note

When the user-defined acceleration/deceleration unit is "ms" (time), the slope of acceleration/deceleration is calculated based on the time from when the writing was performed.

Therefore, when the same data is redundantly written, the slope of acceleration/deceleration will be smaller than that when it was written the first time even if the same data is written. (*1, *2)

*1 When the demand velocity does not reach the target velocity.

*2 Sop operation is excluded.

When the same data is redundantly written, setting the acceleration/deceleration unit to "(User-defined velocity unit)/s" (acceleration/deceleration rate) is recommended.

Example: If the same data is written multiple times when decelerating from high speed to low speed.

- User-defined acceleration/deceleration unit: ms

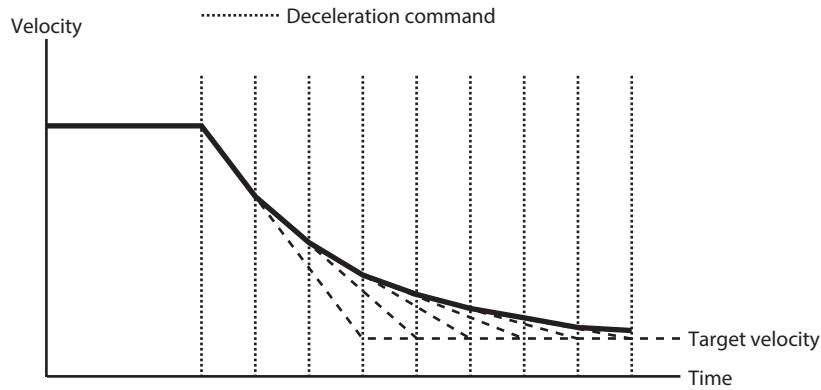

- User-defined acceleration/deceleration unit: (User-defined velocity unit)/s

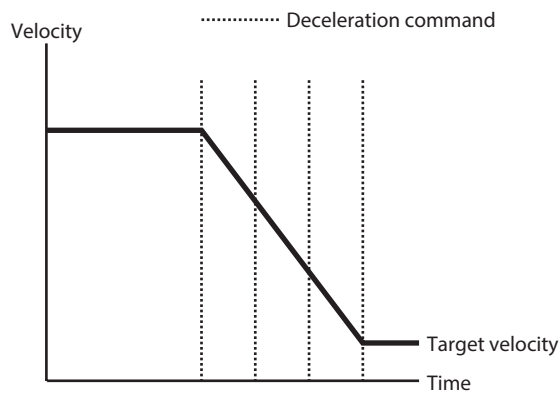

4-7 Timing chart

1. Check the RDY-DD-OPE output is being ON.
2. Send a query (including the trigger and data) to execute direct data operation.
3. When the master sends a query, the MOVE output is turned ON and operation is started.
4. When the motor stops, the MOVE output is turned OFF.

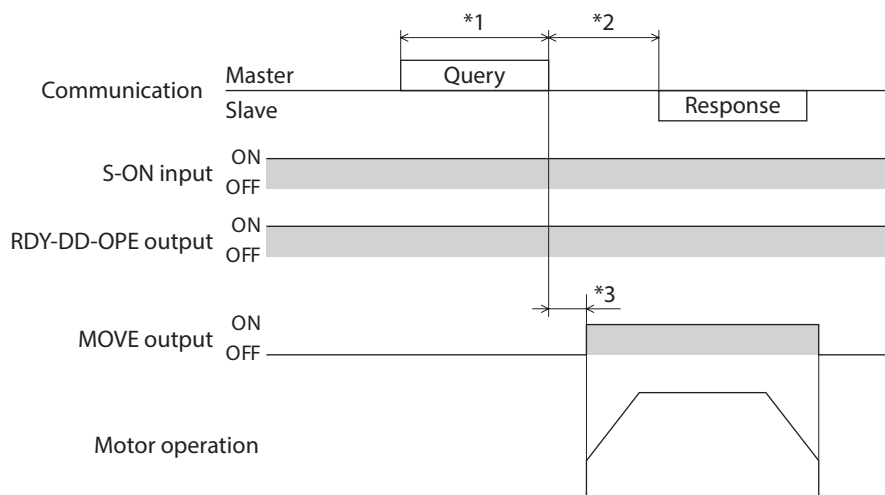
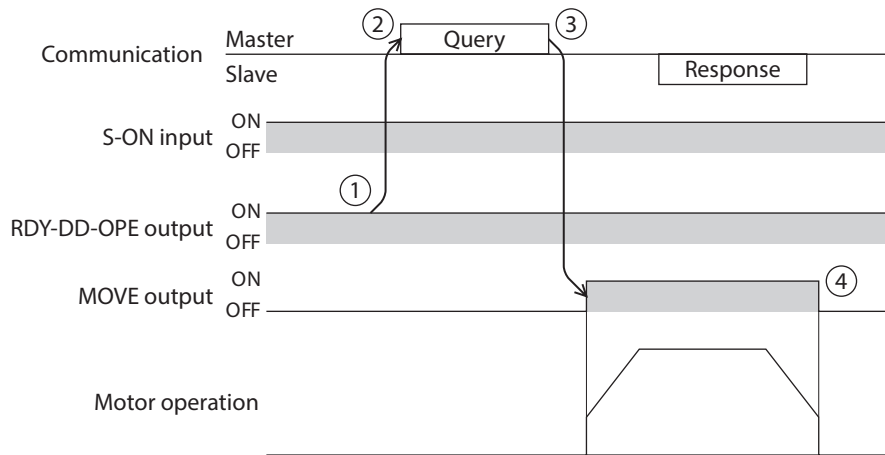

*1 Query via RS-485 communication

*2 $C3.5$ (silent interval) + Longer one from among $Tb4$ (query processing time) and $Tb2$ (transmission waiting time)

*3 $C3.5$ (silent interval) + $Tb4$ (query processing time) + 2 ms or less

5 Stored data operation

Stored data operation is an operation that sets the operation data such as the motor operating velocity and position (travel amount) and executes.

5-1 Types of stored data (SD) operation

2 Operating method

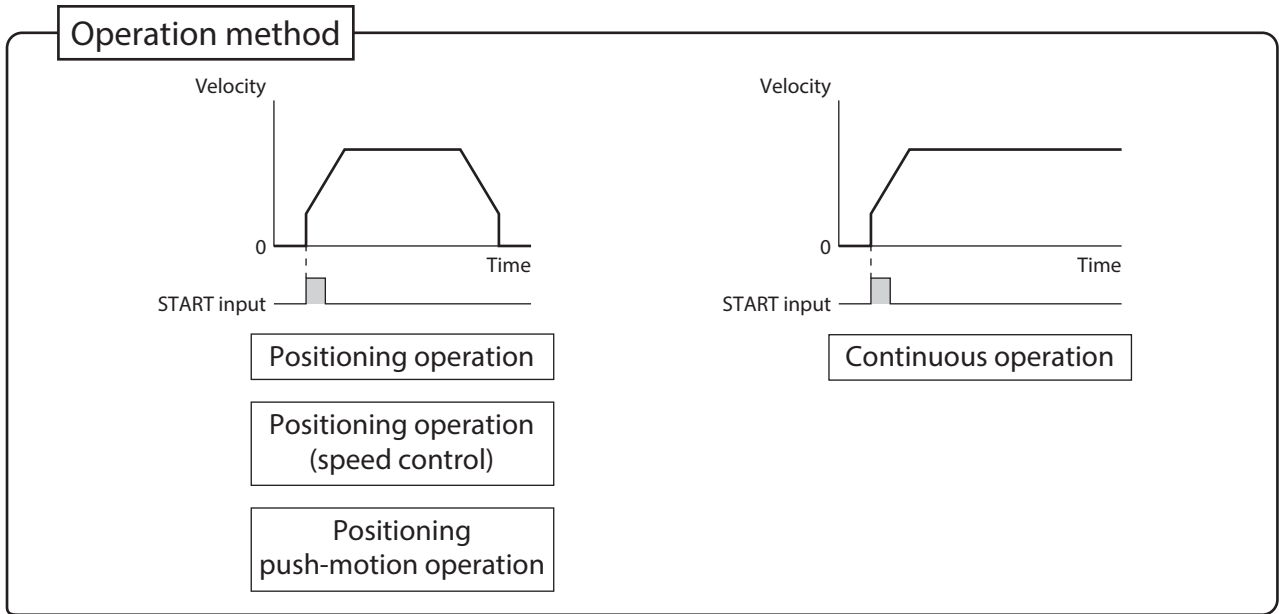

+

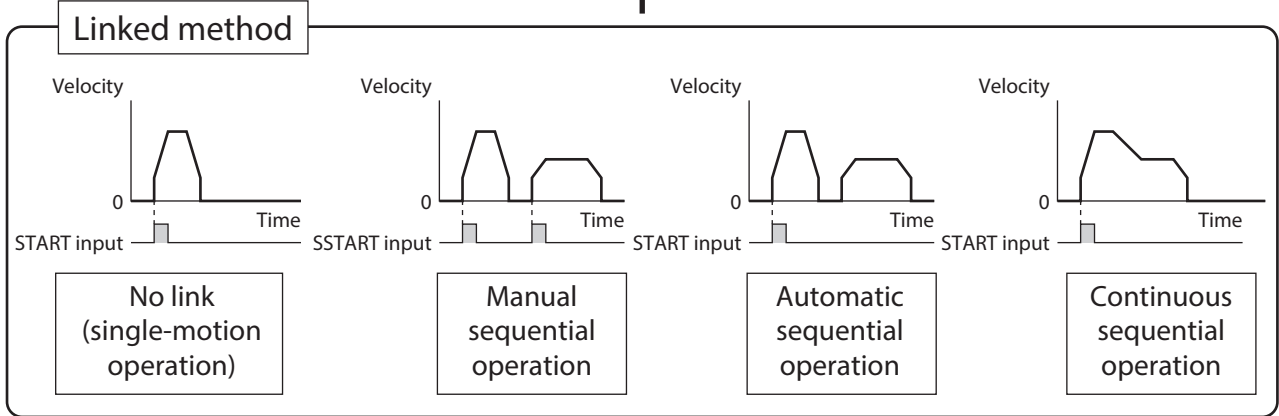

+

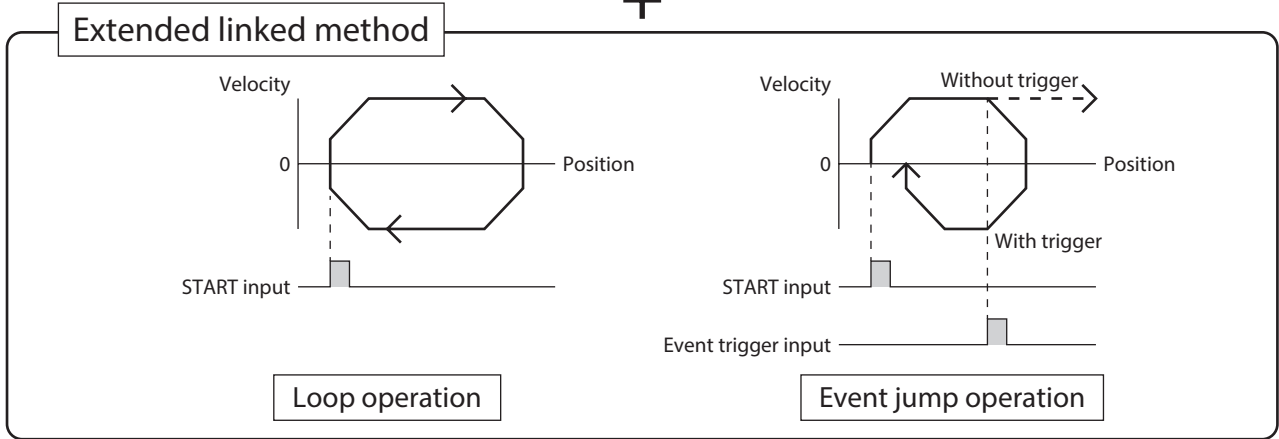

5-2 Setting the data

There are the following two types of settings for stored data operation.

- **Operation data**

Operation type, position, operating velocity, acceleration/deceleration rate, torque limiting value, etc. necessary for stored data operation are set.

- **Operation I/O event**

Conditions to generate an event necessary for the event jump function and the event jump destination and event link of operation when an event is generated are set. Use when the event jump function is used.

- **Operation data**

Name	Description	Initial setting	
		Initial value	Unit
Operation type	Selects the operation type. [Setting range] Refer to "3-4 Selecting the operation type" on p.63.	0	–
Position	Sets the target position (travel amount). It is not used for continuous operation. [Setting range] –2,147,483,648 to 2,147,483,647 (User-defined position unit)	0	step
Operating velocity	Sets the operating velocity. [Setting range] –4,000,000 to 4,000,000 (User-defined velocity unit)	0	r/min
Acceleration rate	Sets the acceleration rate. [Setting range] 1 to 1,000,000,000 ((User-defined velocity unit)/s)	1,000	(r/min)/s
Deceleration rate	Sets the deceleration rate. [Setting range] 1 to 1,000,000,000 ((User-defined velocity unit)/s)	1,000	(r/min)/s
Acceleration time	Sets the acceleration time. [Setting range] 1 to 1,000,000,000 ms	1,000	ms
Deceleration time	Sets the deceleration time. [Setting range] 1 to 1,000,000,000 ms	1,000	ms
Torque limiting value	Sets the torque limiting value. [Setting range] 0 to 10,000 (1=0.1%) *2	10,000	1=0.1%
Drive-complete delay time	Sets the waiting time generated after operation is completed. [Setting range] 0 to 65,535 ms	0	ms
Link	Sets the mode for link operation. [Setting range] 0: No link 1: Manual sequential 2: Automatic sequential 3: Continuous sequential operation	0	–
Next data number	Sets the next data. [Setting range] –256: Stop –2: ↓↓(+2) –1: ↓(+1) 0 to 255: Operation data number	–1	–

Name	Description	Initial setting	
		Initial value	Unit
Area offset	Sets the distance from the center position of the range in which the MAREA output is turned ON to the target position of the positioning operation. [Setting range] -2,147,483,648 to 2,147,483,647 (User-defined position unit)	0	step
Area width	Sets the range in which the MAREA output is turned ON. [Setting range] -1: Disable 0 to 4,194,303 (User-defined position unit)	-1	step
Loop count	Sets the number of times of loop. [Setting range] 0 to 100,000,000	0	-
Loop offset	Offsets the position (travel amount) every time loop is executed. [Setting range] -4,194,304 to 4,194,303 (User-defined position unit)	0	step
Loop end point	Sets to the operation data number in which loop is completed. [Setting range] 0: -(not the loop end point) 1: }L-End (loop end point)	0	-
(Low) I/O event number	Sets the number of the operation I/O event to generate a low event. The condition to generate the event is set in the operation I/O event. [Setting range] -1: -(Disable) 0 to 31: Operation I/O event number	-1	-
(Middle) I/O event number	Sets the number of the operation I/O event to generate a middle event. The condition to generate the event is set in the operation I/O event. [Setting range] -1: -(Disable) 0 to 31: Operation I/O event number	-1	-
(High) I/O event number	Sets the number of the operation I/O event to generate a high event. The condition to generate the event is set in the operation I/O event. [Setting range] -1: -(Disable) 0 to 31: Operation I/O event number	-1	-

*1 This is the operation type used when the operation data is linked. Therefore, the motor will not stop even if the START input is turned ON during operation.

*2 The maximum torque limiting value varies depending on the motor. Refer to p.39 for the maximum value of each motor.

● **Position, operating velocity, acceleration rate, deceleration rate, torque limiting value, drive-complete delay time**

The target position, operating velocity, acceleration/deceleration rate (acceleration/deceleration time), and torque limiting value necessary for stored data operation are set.

● Positioning operation

User-defined acceleration/deceleration unit:
(User-defined velocity unit)/s

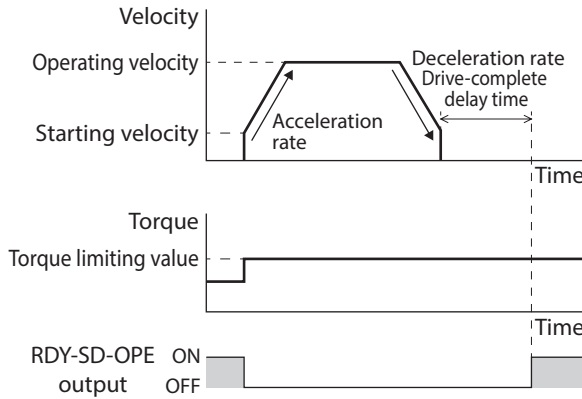

User-defined acceleration/deceleration unit: ms

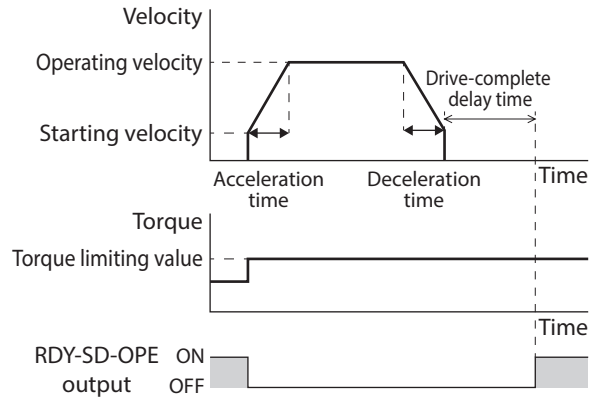

● Continuous operation

User-defined acceleration/deceleration unit:
(User-defined velocity unit)/s

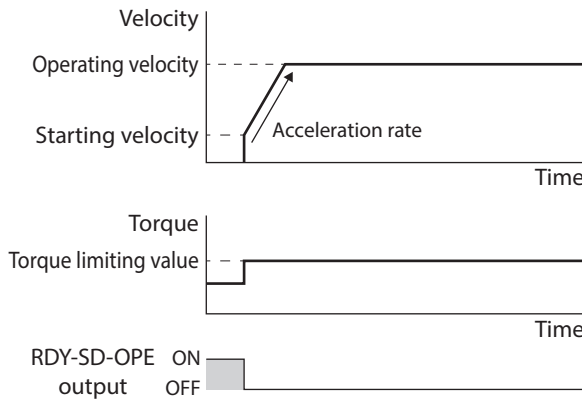

User-defined acceleration/deceleration unit: ms

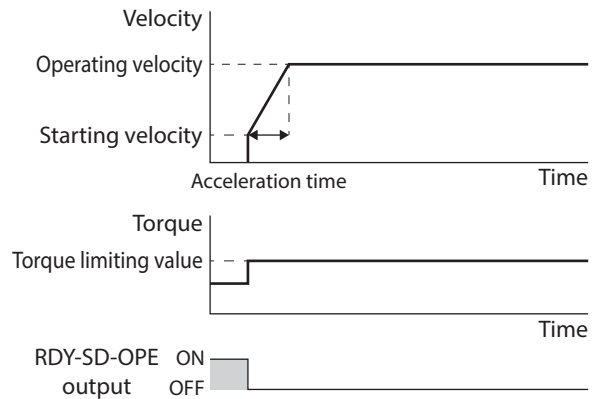

● When operating velocity is faster than starting velocity

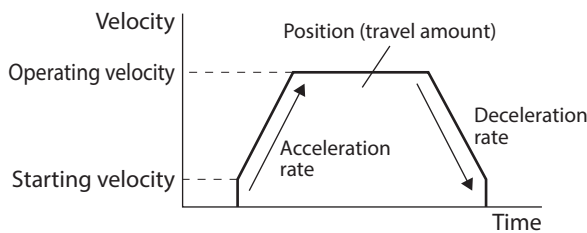

● When starting velocity is equal to or faster than operating velocity

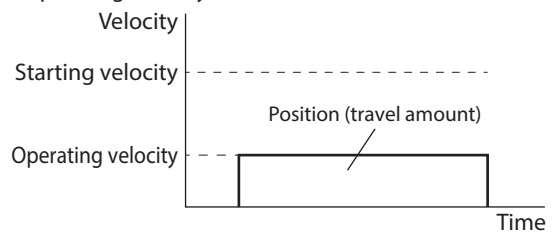

● **Link and next data number**

- No link
Operation is executed once with a single operation data number. (single-motion operation)
- Manual sequential
Operation based on the operation data number set in the "Next data number" is executed whenever the SSTART input is turned ON.
The SSTART input is enabled when the RDY-SD-OPE output is ON.
- Automatic sequential
Operation based on the operation data number set in the "Next data number" is automatically started after stop for the time set in the "Drive-complete delay time."
- Continuous sequential operation
Operation based on the operation data number set in the "Next data number" is executed without stopping the motor.

● **Area offset, area width**

Setting the area offset or the area width can set the range of the MAREA output for each operation data.

When the operation direction is the forward direction

● **Positioning operation**

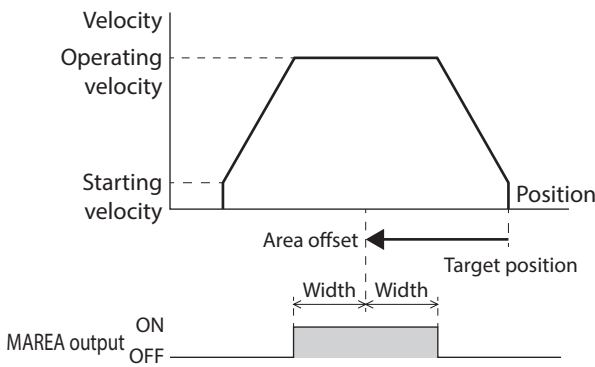

● **Continuous operation**

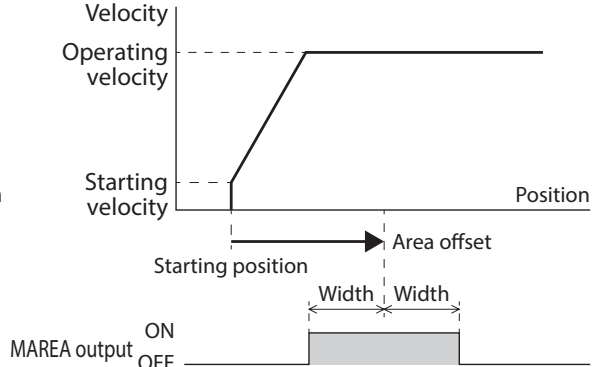

● **Loop count, loop offset, loop end point**

If the loop count, the loop offset, and the loop end point are set, the loop function is enabled.

● **(Low) I/O event number, (middle) I/O event number, (high) I/O event number**

If the (low) I/O event number, the (middle) I/O event number, the (high) I/O event number are set, the event jump function is enabled.

When they occur simultaneously, they operate according to the following priority.

In descending order: (High) I/O event number - (Middle) I/O event number - (Low) I/O event number

5-3 Operation I/O event

This is the operation I/O event necessary for setting the (low) I/O event number, the (middle) I/O event number, and the (high) I/O event number.

Name	Description	Initial setting	
		Initial value	Unit
Link	Sets the linked method after event trigger detection. [Setting range] 0: No link 1: Manual sequential 2: Automatic sequential 3: Continuous sequential operation	0	–
Next data number	Sets the next data. [Setting range] –256: Stop –2: ↓↓(+2) –1: ↓(+1) 0 to 255: Operation data number	–256	–
Dwell	Sets the waiting time generated after event trigger detection. [Setting range] 0 to 1,000,000 ms	0	ms
Event trigger I/O	Sets I/O to be used as an event trigger. [Setting range] "2 Signals list" on p.151	0: Not used	–
Event trigger type	Sets the timing to detect the event trigger. [Setting range] 0: Not event execution 1: ON (calculated cumulative: ms) 2: ON (continuous: ms) 3: OFF (calculated cumulative: ms) 4: OFF (continuous: ms) 5: ON (form: positive edge↑) 6: OFF(form: negative edge↓) 7: ON (cumulative: ms) 8: OFF (cumulative: ms)	0	–
Event trigger counter	Sets the judgment time to detect the event trigger or the number of times of detection. [Setting range] 0 to 1,000,000 (1=1 ms or 1=once)	0	–

● Link, next data number

Sets the linked method and the next data number when the event trigger is detected. There are the following four modes for link.

- No link
The event is ignored.
- Manual sequential
This makes the present operation decelerate to a stop. Then, after the time set in "Dwell" is elapsed, the RDY-SD-OPE output is turned ON. If the SSTART input is turned ON, the operation based on the operation data number set in the "Next data number" is executed.
- Automatic sequential
This makes the present operation decelerate to a stop. Then, after the time set in "Dwell" is elapsed, the operation based on the operation data number set in the "Next data number" is automatically started.
- Continuous sequential operation
The operation based on the operation data number set in the "Next data number" is started without stopping the operation.

5-4 Operation data number selection

There are the following three methods to select the operation data number to be started.

- Selection by NET selection number
- Direct selection (D-SEL0 to D-SEL15)
- Selection by M0 to M7 inputs

The priority is applied according to the following order: NET selection number, direct selection, M0 to M7 inputs.

● NET selection number

The NET selection number is a method that sets the operation data number with remote I/O.

If an operation data number other than 0 to 255 is set, the NET selection number is disabled and the direct selection or the selection by the M0 to M7 inputs is enabled.

● Direct selection

The direct selection is a method in which the operation data number is set with parameters and selected with D-SEL0 to D-SEL15 inputs.

If all D-SEL0 to D-SEL15 inputs are turned OFF or two or more inputs are turned ON, the direct selection is disabled and the selection by the M0 to M7 inputs is enabled.

Related parameters

Parameter name	Description	Initial setting	
		Initial value	Unit
D-SEL drive start function	Sets how to start the motor when the D-SEL input is turned ON. [Setting range] 0: Operation data number selection only 1: Operation data number selection + START function	1	–
D-SEL0 operation number selection	Sets the corresponding operation data number to be started when each D-SEL input is turned ON. [Setting range] 0 to 255: Operation data number	0	–
D-SEL1 operation number selection		1	–
D-SEL2 operation number selection		2	–
D-SEL3 operation number selection		3	–
D-SEL4 operation number selection		4	–
D-SEL5 operation number selection		5	–
D-SEL6 operation number selection		6	–
D-SEL7 operation number selection		7	–
D-SEL8 operation number selection		8	–
D-SEL9 operation number selection		9	–
D-SEL10 operation number selection		10	–
D-SEL11 operation number selection		11	–
D-SEL12 operation number selection		12	–
D-SEL13 operation number selection		13	–
D-SEL14 operation number selection		14	–
D-SEL15 operation number selection	15	–	

- **Selection by M0 to M7 inputs**

This is a method in which a desired operation data number is selected by a combination of ON-OFF status of the M0 to M7 inputs.

Operation data number	M7	M6	M5	M4	M3	M2	M1	M0
0	OFF	OFF	OFF	OFF	OFF	OFF	OFF	OFF
1	OFF	OFF	OFF	OFF	OFF	OFF	OFF	ON
2	OFF	OFF	OFF	OFF	OFF	OFF	ON	OFF
⋮	⋮	⋮	⋮	⋮	⋮	⋮	⋮	⋮
253	ON	ON	ON	ON	ON	ON	OFF	ON
254	ON	ON	ON	ON	ON	ON	ON	OFF
255	ON	ON	ON	ON	ON	ON	ON	ON

5-5 Operating method and timing chart

■ Positioning operation

● Operating method

1. Check the RDY-SD-OPE output is being ON.
2. Select the operation data number using the M0 to M7 inputs, and turn the START input ON.
3. The RDY-SD-OPE output is turned OFF and the motor starts operation.
4. Check the RDY-SD-OPE output has been turned OFF and turn the START input OFF.
5. When the operation is completed, the RDY-SD-OPE output is turned ON.

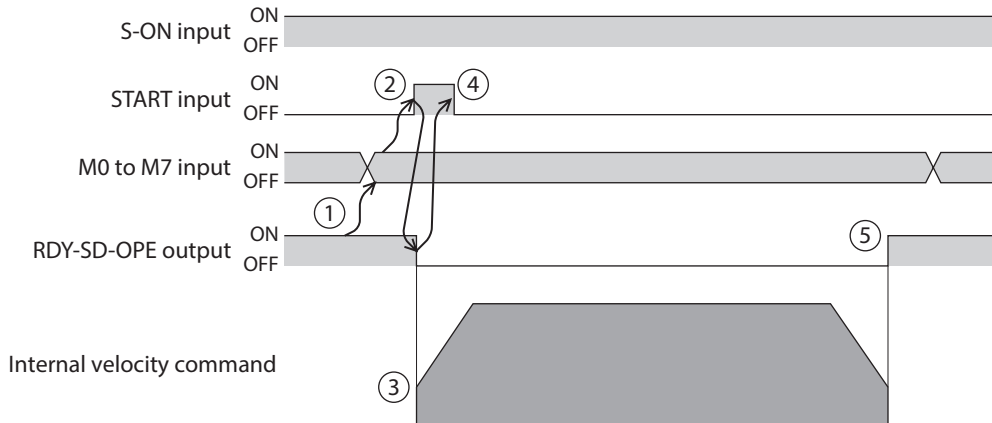

● Timing chart

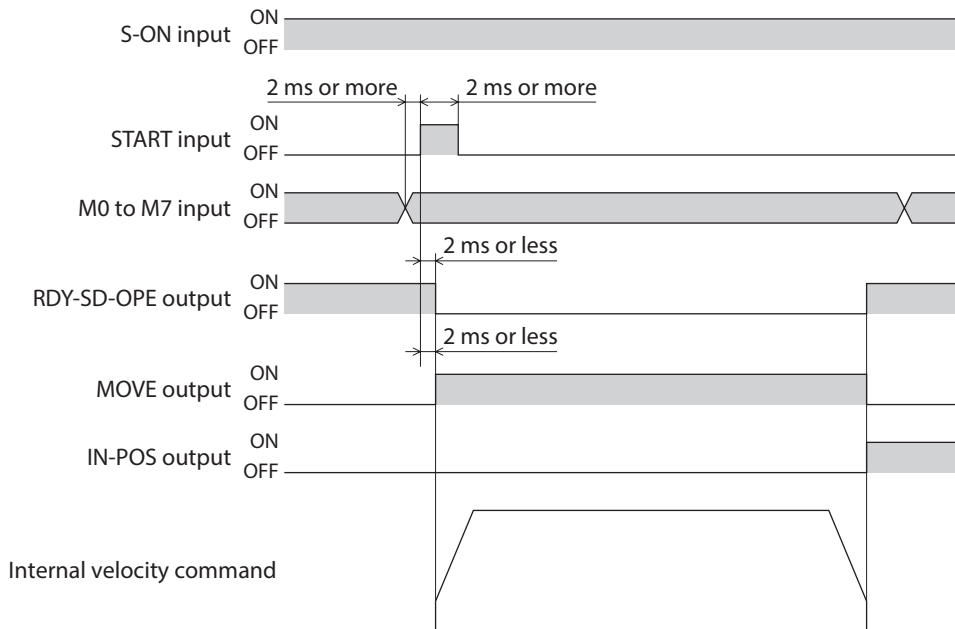

■ Continuous operation

● Operating method

1. Check the RDY-SD-OPE output is being ON.
2. Select the operation data number using the M0 to M7 inputs, and turn the START input ON. The RDY-SD-OPE output is turned OFF and the motor starts operation.
3. Check the RDY-SD-OPE output has been turned OFF and turn the START input OFF.
4. If the STOP input is turned ON, the motor starts deceleration stop.
5. When the motor stops, the RDY-SD-OPE output is turned ON.

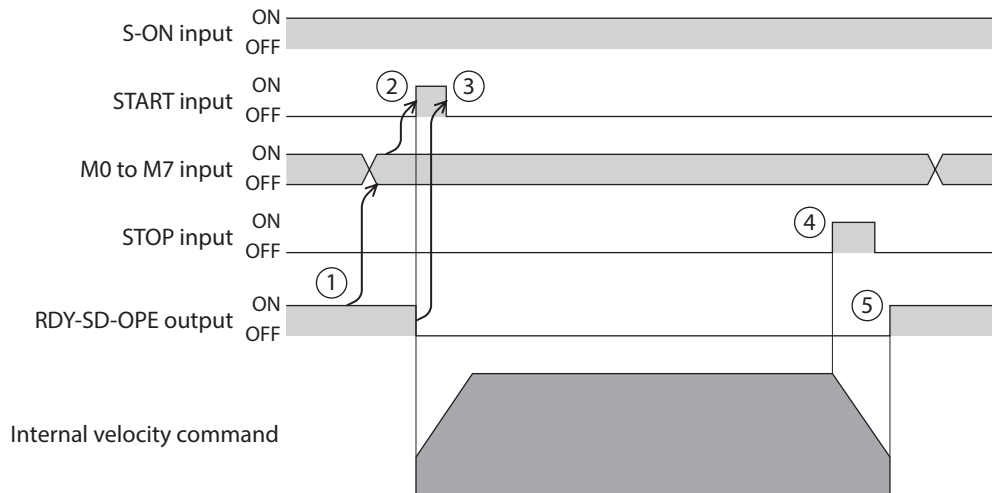

● Timing chart

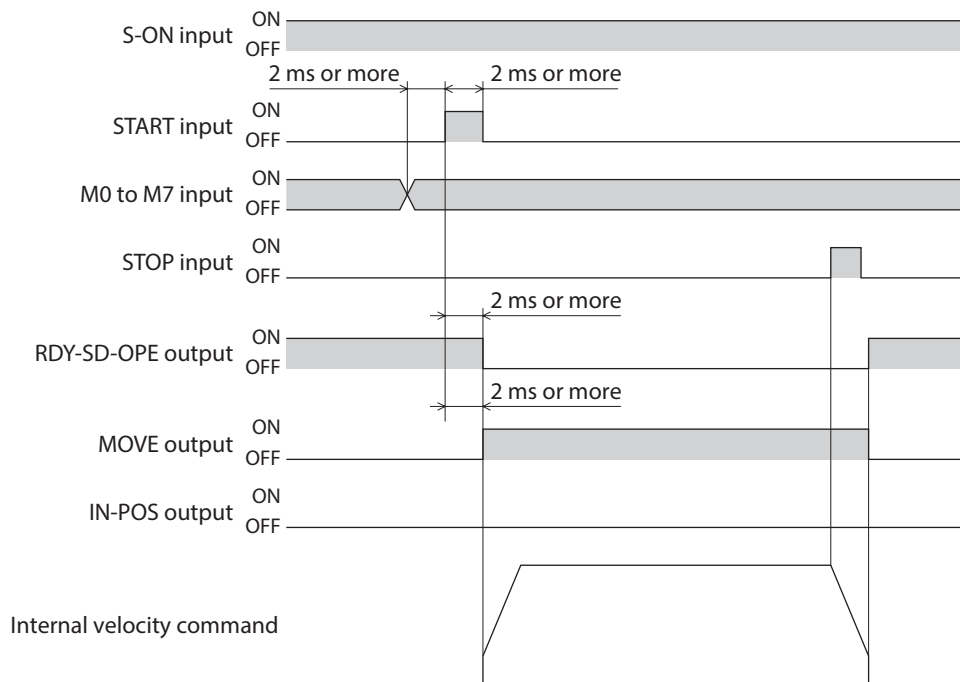

5-6 Link method of operation data

Operations of two or more operation data numbers are linked. If the base point for linked operation is changed using the M0 to M7 inputs or the D-SEL0 to D-SEL15 inputs, linked operation with multiple operation patterns can be set. This can be used when a different operation pattern for each load is set.

The timing to transition to the operation data number of the next data varies depends on the operation method.

- **Positioning operation, positioning push-motion operation**

- When the demand position reaches the target position
- When the NEXT input is turned ON.
- When the event jump function is executed

- **Continuous operation**

- When the NEXT input is turned ON.
- When the event jump function is executed

- **No link**

Operation is executed once with a single operation data number.

Related I/O signals

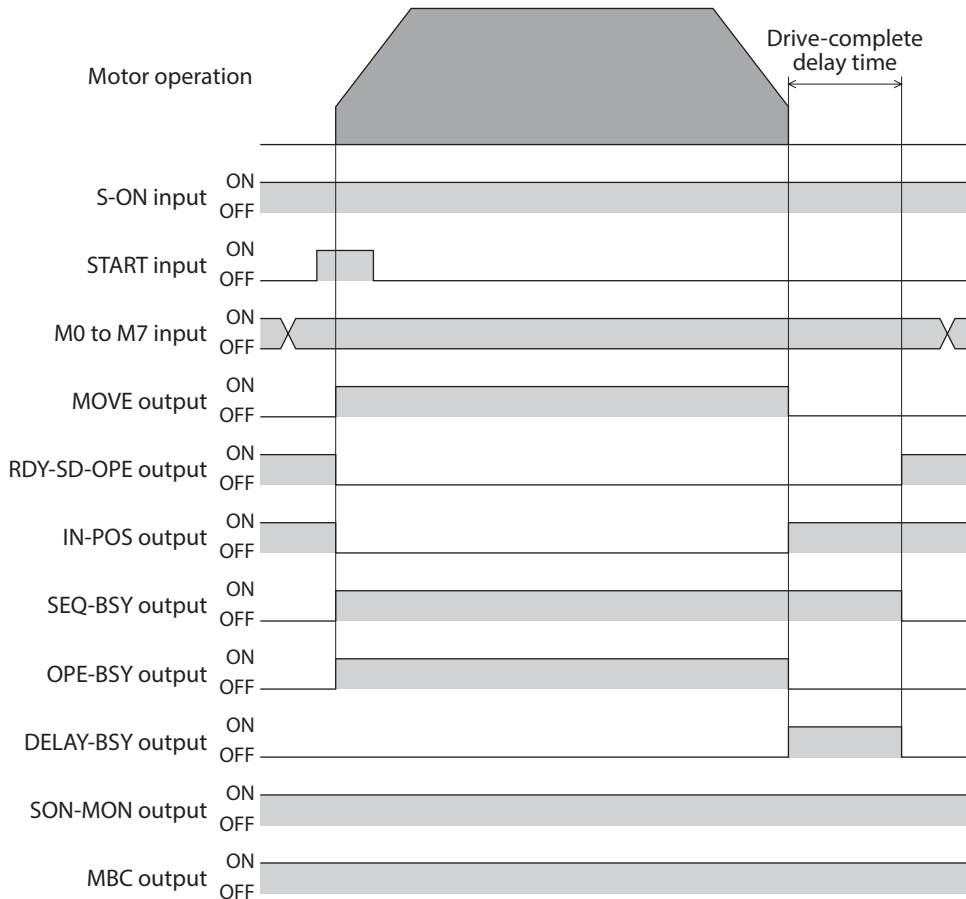

Manual sequential operation

Operation based on the operation data number set in the "Next data number" is executed whenever the SSTART input is turned ON. This is a convenient method when multiple positioning operations are performed sequentially because there is no need to repeatedly select each operation data number.



- If the SSTART input is turned ON in a state where the SEQ-BSY output is ON (manual sequential standby state), the operation data number set in the "Next data number" is executed.
- If the SSTART input is turned ON in a state where the SEQ-BSY output is OFF, the operation data number presently selected is executed.

● Example of use: When positioning operation is performed to multiple coordinates at a desired time

Setting the operation data

No.	Operation type	Position [step]	Operating velocity [r/min]	Acceleration time [ms]	Deceleration time [ms]
No.0	Absolute positioning	1000	1500	1000	1000
No.1	Absolute positioning	2000	2000	2000	2000
No.2	Absolute positioning	300	1500	1000	1000

No.	Torque limiting value [%]	Drive-complete delay time [ms]	Link	Next data number
No.0	1000.0	0	Manual sequential	↓ (+1)
No.1	1000.0	0	Manual sequential	↓ (+1)
No.2	1000.0	0	No link	Stop

Operation example

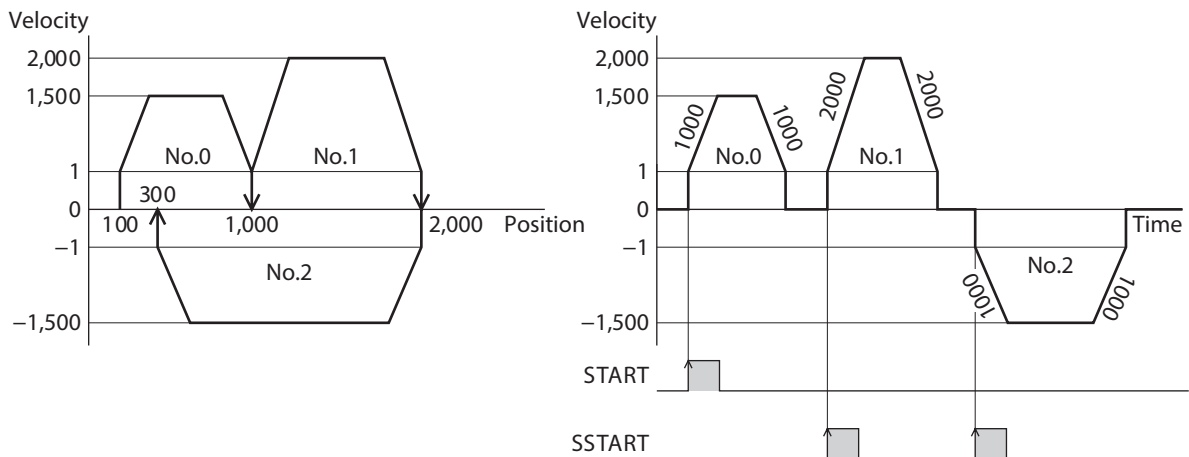

Timing chart

1. Check the RDY-SD-OPE output is being ON.
2. Select the operation data number using the M0 and M7 inputs.
3. Turn the START input ON.
The RDY-SD-OPE output is turned OFF and the SEQ-BSY output is turned ON, and the motor starts operation.
4. Check the RDY-SD-OPE output has been turned OFF and turn the START input OFF.
5. When the operation is completed, the RDY-SD-OPE output is turned ON.
6. Check the RDY-SD-OPE output has been turned ON and turn the SSTART input ON.
The operation of the linked operation data number by manual sequential is started.
7. Check the RDY-SD-OPE output has been turned OFF and turn the SSTART input OFF.
8. When all linked operations are completed, the SEQ-BSY output is turned OFF and the RDY-SD-OPE output is turned ON.

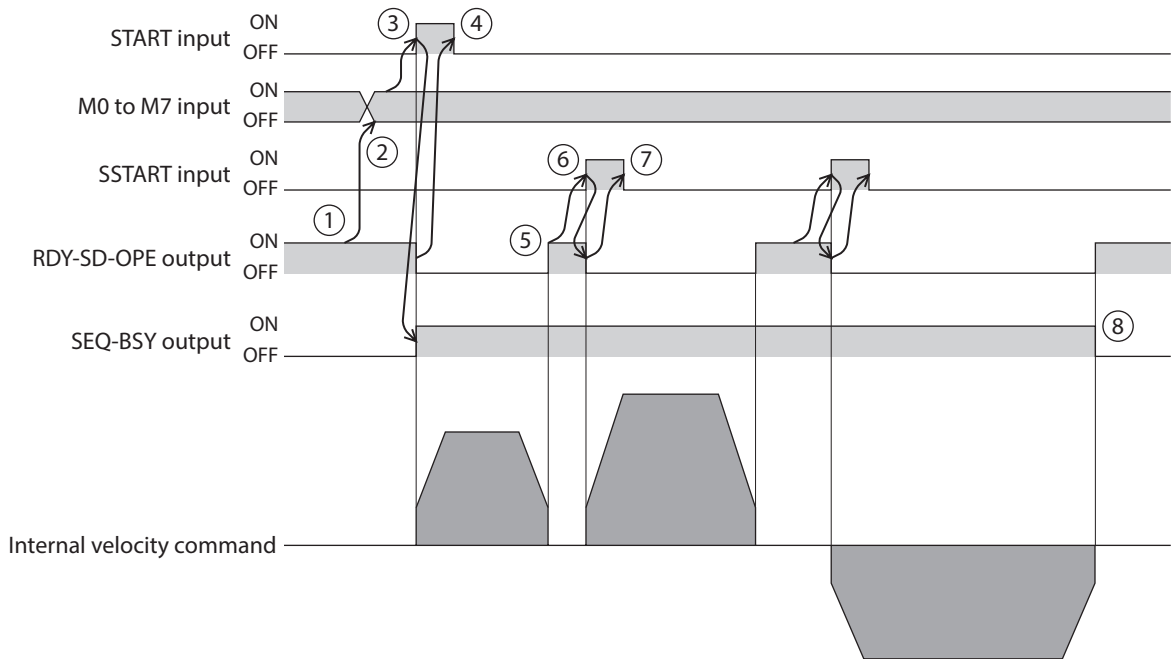

Related I/O signals

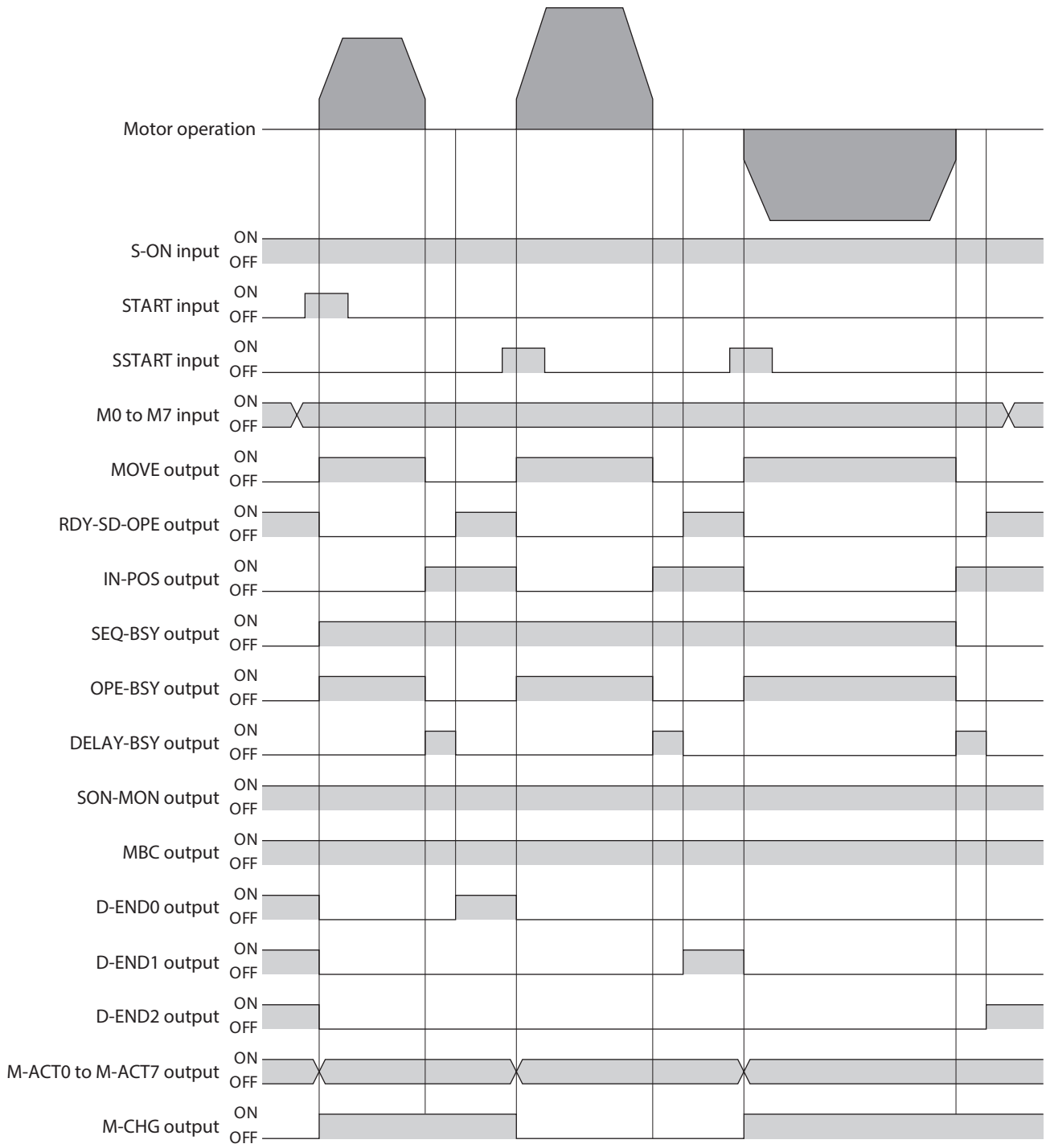

■ Automatic sequential operation

Two or more operations are automatically executed in sequence. After one operation is completed, operation of the operation data number set in the "Next data number" is started after stop for the time set in the "Drive-complete delay time." If there is operation data that "No link" is set, the motor operates stored data operation sequentially and stops when the operation data of "No link" is completed.

- Example of use: When positioning operation is automatically performed to multiple coordinates

Setting the operation data

	Operation type	Position [step]	Operating velocity [r/min]	Acceleration time [ms]	Deceleration time [ms]
No.0	Absolute positioning	1000	1500	1000	1000
No.1	Absolute positioning	2000	2000	2000	2000
No.2	Absolute positioning	300	1500	1000	1000

	Torque limiting value [%]	Drive-complete delay time [ms]	Link	Next data number
No.0	1000.0	5000	Automatic sequential	↓ (+1)
No.1	1000.0	5000	Automatic sequential	↓ (+1)
No.2	1000.0	0	No link	Stop

Operation example

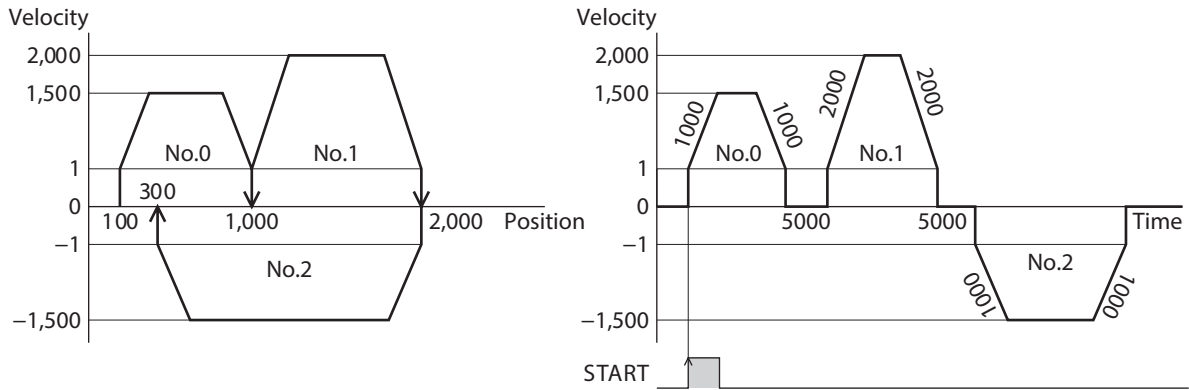

Timing chart

1. Check the RDY-SD-OPE output is being ON.
2. Select the operation data number using the M0 and M7 inputs.
3. Turn the START input ON.
The RDY-SD-OPE output is turned OFF and the SEQ-BSY output is turned ON, and the motor starts operation.
4. Check the RDY-SD-OPE output has been turned OFF and turn the START input OFF.
5. When the first operation is completed, operation linked in "Automatic sequential" is started after stop for time set in the "Drive-complete delay time."
6. When all linked operations are completed, the SEQ-BSY output is turned OFF and the RDY-SD-OPE output is turned ON.

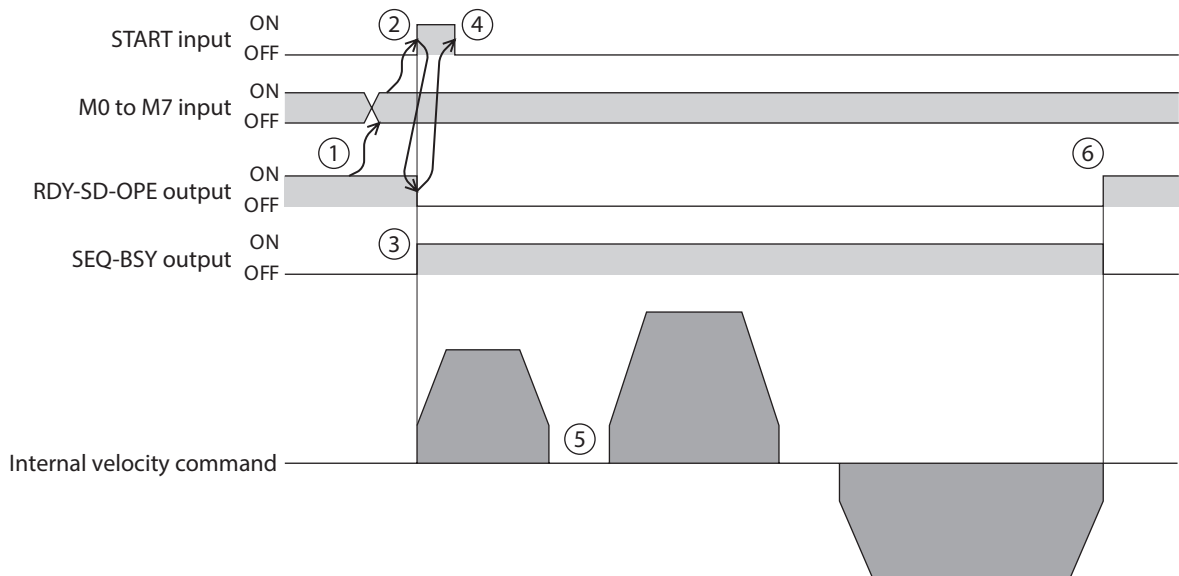

Related I/O signals

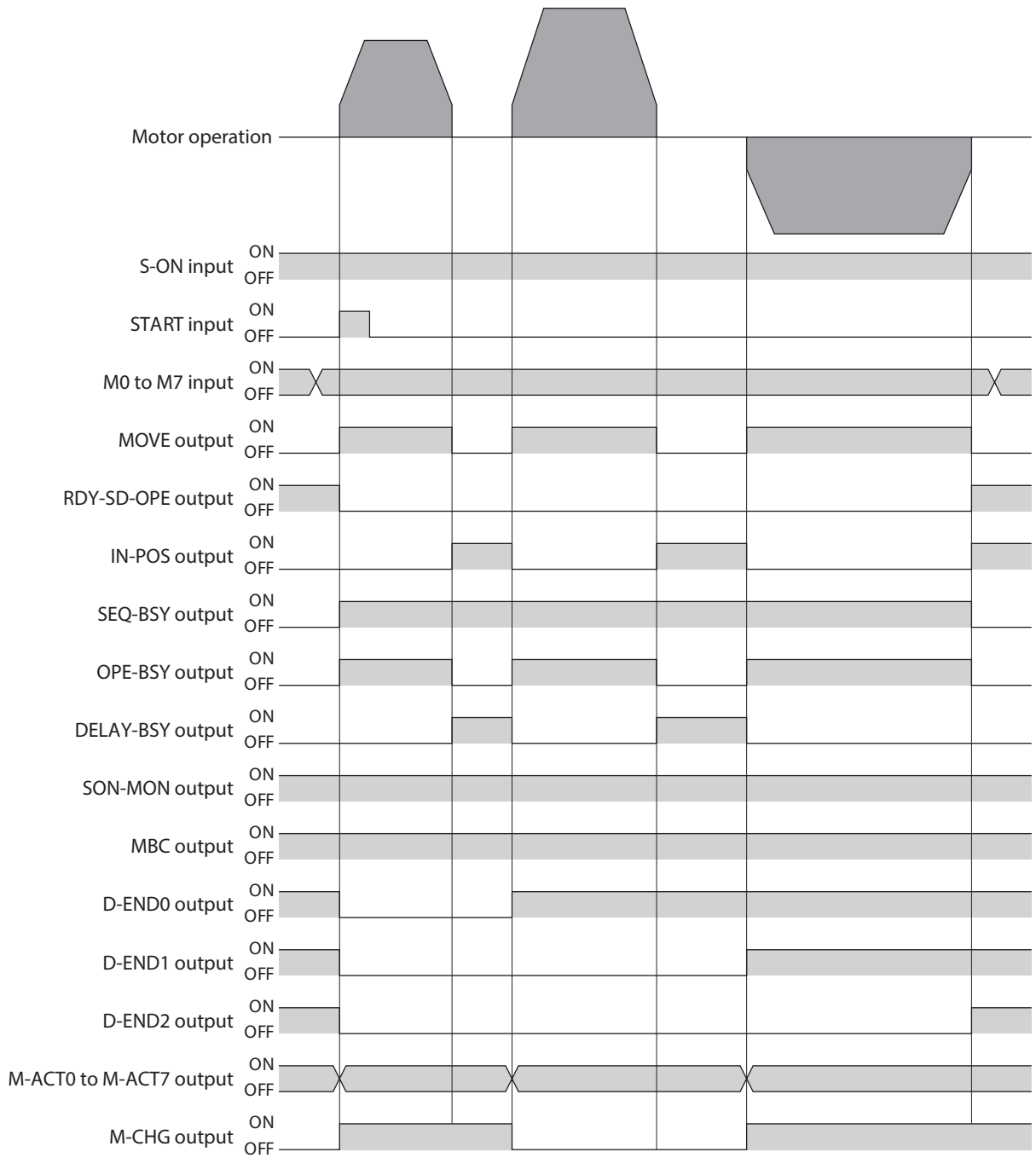

■ Continuous sequential operation

Operation based on the operation data number set in the "Next data number" is executed continuously without stopping the motor. If there is operation data that "No link" is set, the motor operates stored data operation sequentially and stops when the operation data of "No link" is completed.

● Example of use: When the velocity is changed at positions specified

Setting the operation data

	Operation type	Position [step]	Operating velocity [r/min]	Acceleration time [ms]	Deceleration time [ms]
No.0	Absolute positioning	1000	2000	2000	1000
No.1	Absolute positioning	1700	3000	1000	2000
No.2	Absolute positioning	3000	1000	2000	2000
No.3	Absolute positioning	1300	2000	1500	1000

	Torque limiting value [%]	Drive-complete delay time [ms]	Link	Next data number
No.0	1000.0	0	Continuous sequential operation	↓ (+1)
No.1	1000.0	0	Continuous sequential operation	↓ (+1)
No.2	1000.0	0	Continuous sequential operation	↓ (+1)
No.3	1000.0	0	No link	Stop

Operation example

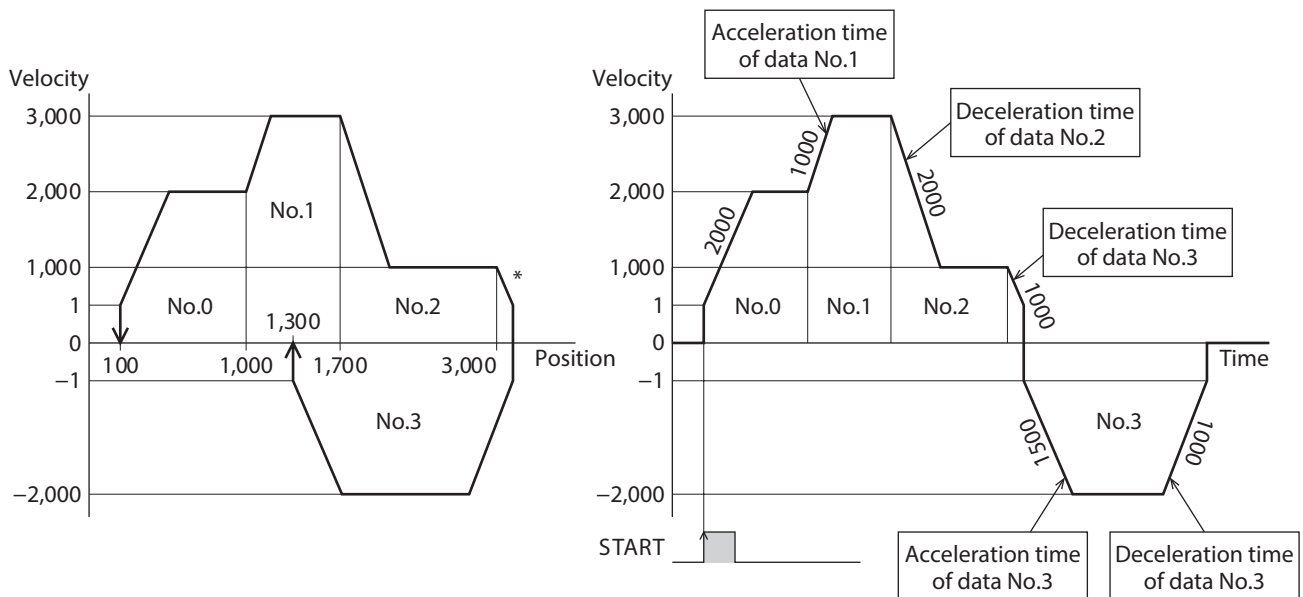

* If the direction of operation is switched to the opposite direction in the middle of operation, the target position will be exceeded.



- When operation is linked to the next operation data number, the motor accelerates according to the acceleration time of the next data number.
- If operation of the next data number was set to the rotation in the opposite direction, the motor decelerates according to the deceleration time of the next data number. However, in the case of positioning operation and positioning push-motion operation, the motor decelerates with the inclination according to the operating profile of the next data number.
- When stopped, the motor decelerates according to the deceleration time of the operation data number linked at last.

Timing chart

1. Check the RDY-SD-OPE output is being ON.
2. Select the operation data number using the M0 and M7 inputs.
3. Turn the START input ON.
The RDY-SD-OPE output is turned OFF and the SEQ-BSY output is turned ON, and the motor starts operation.
4. Check the RDY-SD-OPE output has been turned OFF and turn the START input OFF.
5. When the motor reaches the target position during operation, the operation transitions to the next operation linked, and the motor starts acceleration/deceleration from the present velocity to the target velocity.
6. When all linked operations are completed, the SEQ-BSY output is turned OFF and the RDY-SD-OPE output is turned ON.

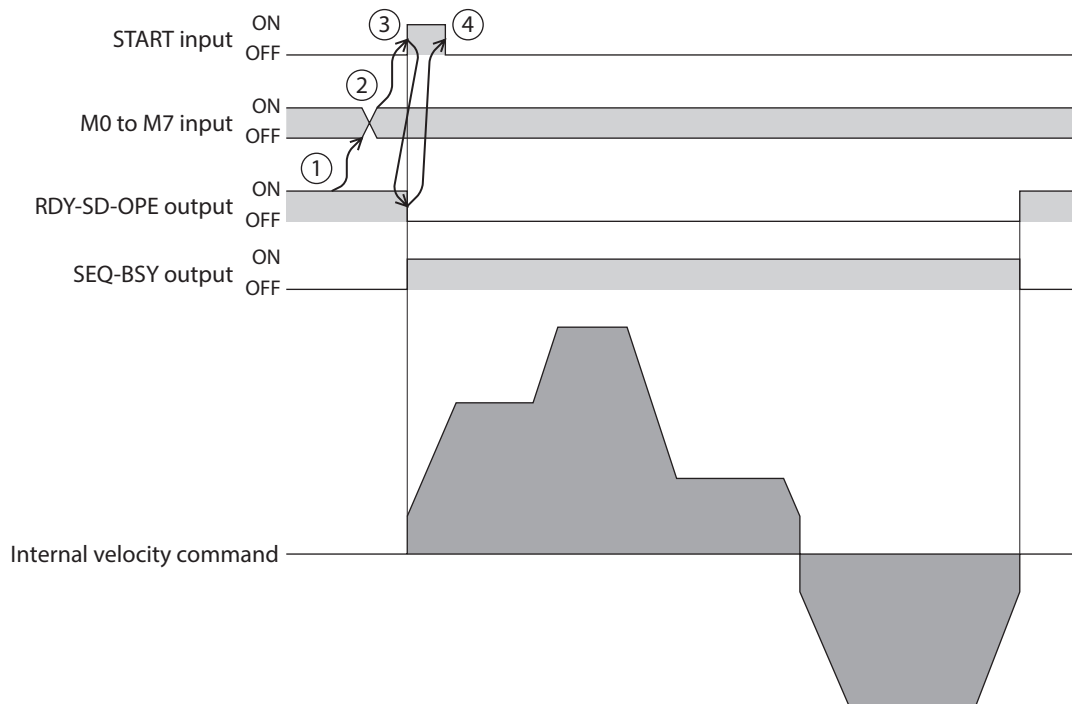

Related I/O signals

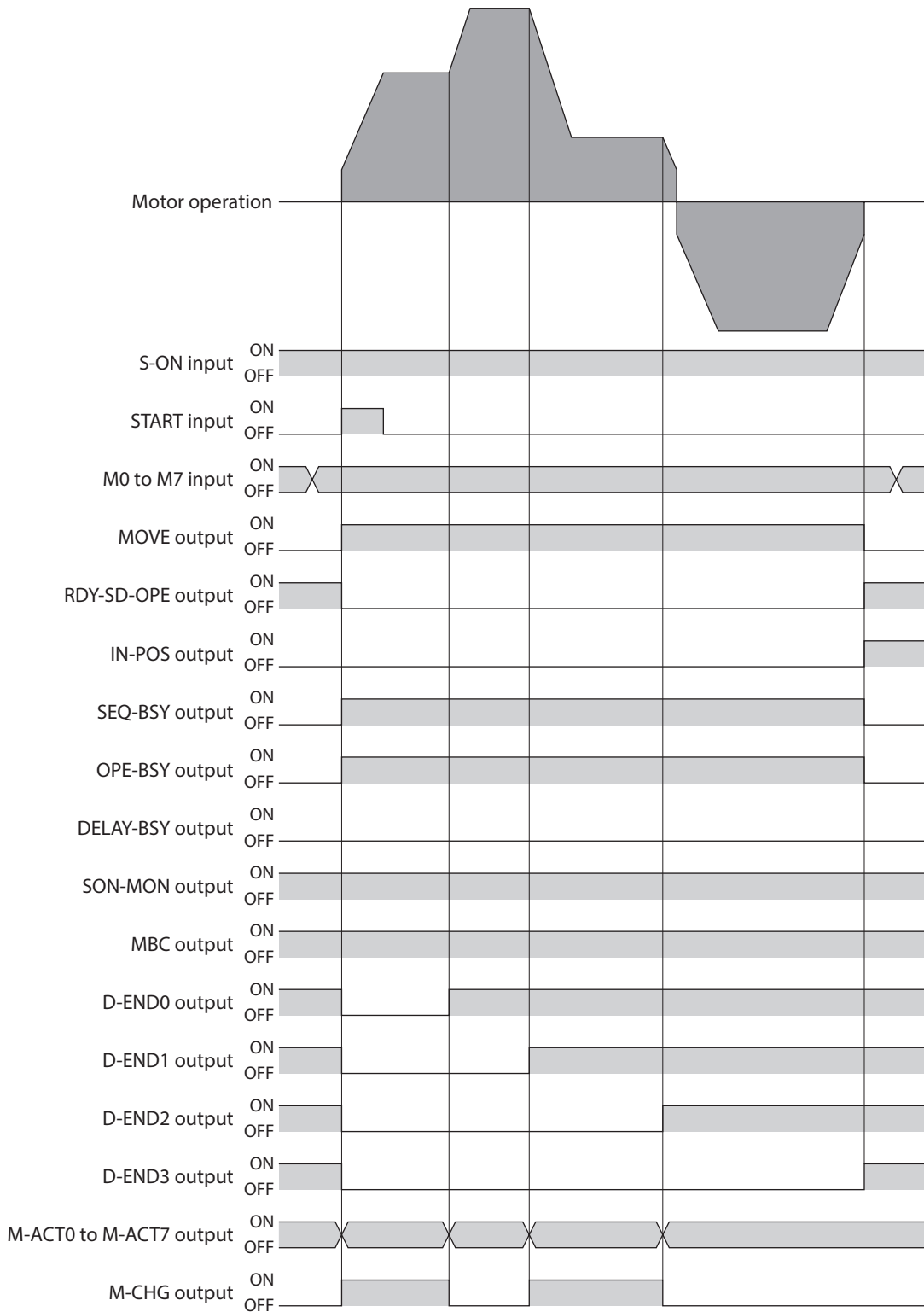

2 Operating method

5-7 Sequence function

■ Loop function

The loop function is a function that repeats the operation of the linked operation data numbers for the number of set times.

From the operation data number having set the "Loop count" until the operation data number having set the "Loop end point," operation is repeated for the number of times set in the "Loop count." When the operation for the number of set times is completed, the operation transitions to the operation data number that is set to the "Next data number."

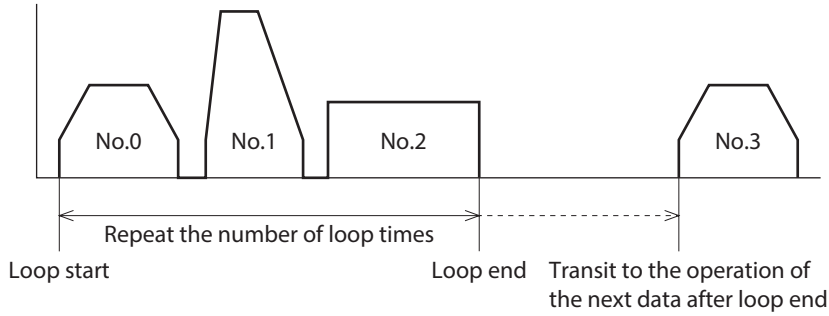

If "No link" is included in the "Link" of the operation data number to be looped, the motor will stop when operation of the operation data number that "No link" was set is completed. Be sure to link all operations using "Manual sequential," "Automatic sequential," or "Continuous sequential operation."

- Example of use: When operation from the operation data No.0 to No.1 is repeated three times.

Setting the operation data

	Operation type	Position [step]	Operating velocity [r/min]	Acceleration time [ms]	Deceleration time [ms]
No.0	Absolute positioning	5000	2000	1500	1500
No.1	Absolute positioning	100	2000	1500	1500
No.2	Absolute positioning	2000	1000	1500	1500

	Torque limiting value [%]	Drive-complete delay time [ms]	Link	Next data number
No.0	1000.0	0	Automatic sequential	↓ (+1)
No.1	1000.0	0	Automatic sequential	↓ (+1)
No.2	1000.0	0	No link	Stop

	Area offset	Area width	Loop count	Loop offset [step]	Loop end point
No.0	0	-1	3	0	-
No.1	0	-1	0	0	} L-End
No.2	0	-1	0	0	-

Operation example

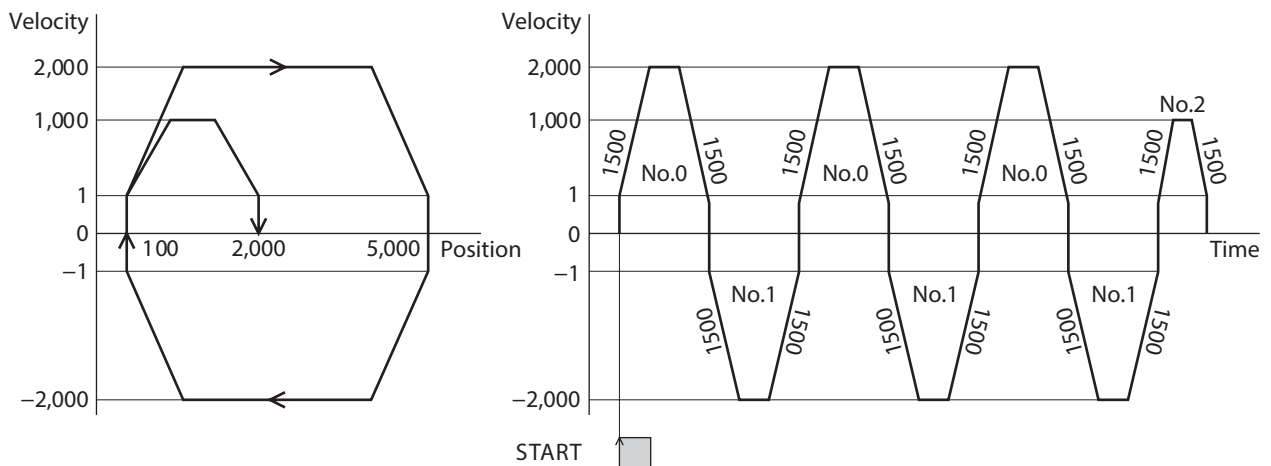

● **Offset of loop**

If an offset is set, the target position for positioning can be shifted by the amount set in the "Loop offset" while repeating the loop. Use for palletizing operation, etc.

**Example of use: When operation from the operation data No.0 to No.1 is repeated three times.
(When the target position is increased by 100 steps every time loop is executed)**

Setting the operation data

- In absolute positioning:
The coordinates of the target position is offset.

	Operation type	Position [step]	Operating velocity [r/min]	Acceleration time [ms]	Deceleration time [ms]
No.0	Absolute positioning	1000	1200	1500	1500
No.1	Absolute positioning	100	1200	1500	1500

	Torque limiting value [%]	Drive-complete delay time [ms]	Link	Next data number	Area offset	Area width	Loop count	Loop offset [step]	Loop end point
No.0	1000.0	0	Automatic sequential	↓ (+1)	0	-1	3	100	-
No.1	1000.0	0	Automatic sequential	Stop	0	-1	0	0	} L-End

- In incremental positioning:
The travel amount to the target position is offset.

	Operation type	Position [step]	Operating velocity [r/min]	Acceleration time [ms]	Deceleration time [ms]
No.0	Incremental positioning (based on demand position)	900	1200	1500	1500
No.1	Incremental positioning (based on demand position)	-900	1200	1500	1500

	Torque limiting value [%]	Drive-complete delay time [ms]	Link	Next data number	Area offset	Area width	Loop count	Loop offset [step]	Loop end point
No.0	1000.0	0	Automatic sequential	↓ (+1)	0	-1	3	100	-
No.1	1000.0	0	Automatic sequential	Stop	0	-1	0	-100	} L-End

Operation example

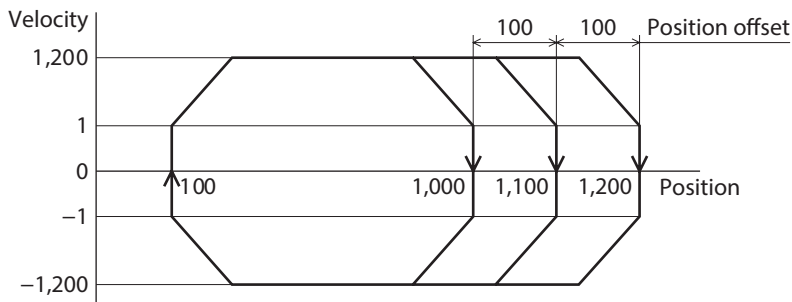

■ Event jump function

The event jump function is a function that branches the operation by turning ON-OFF the signal set in the "Event trigger I/O" of the operation I/O event. The operation transitions to the "Next data number" forcibly when the event trigger I/O is detected during linked operation or loop operation. Three types can be set for a single operation data: "(Low) I/O event number," "(Middle) I/O event number," and "(High) I/O event number." When they occur simultaneously, they operate according to the following priority.

In descending order: (High) I/O event number - (Middle) I/O event number - (Low) I/O event number

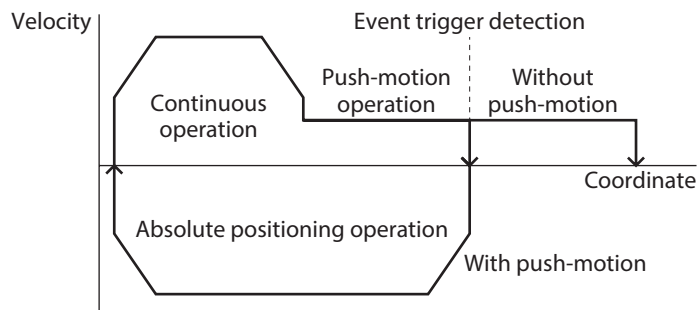

● **Types of event trigger**

● ON (form: positive edge↑)

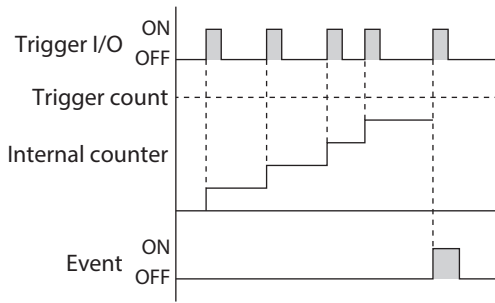

● OFF (form: negative edge↓)

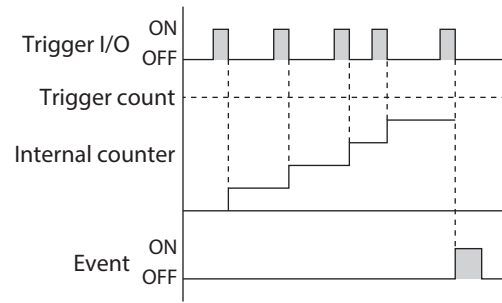

● ON (continuous: ms)

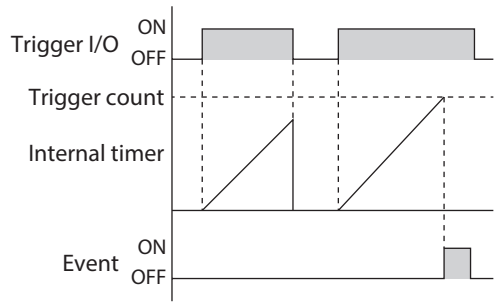

● OFF (continuous: ms)

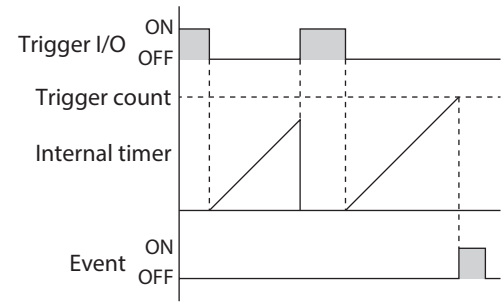

● ON (calculated cumulative: ms)

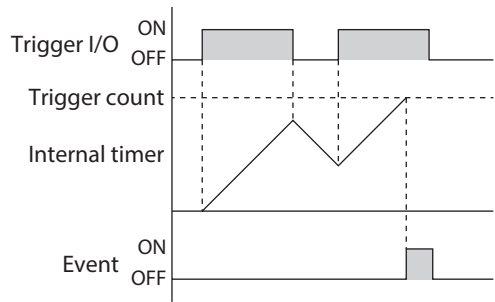

● OFF (calculated cumulative: ms)

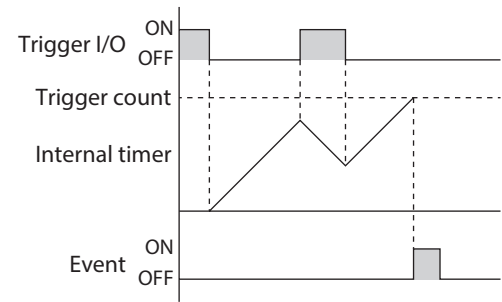

● ON (cumulative: ms)

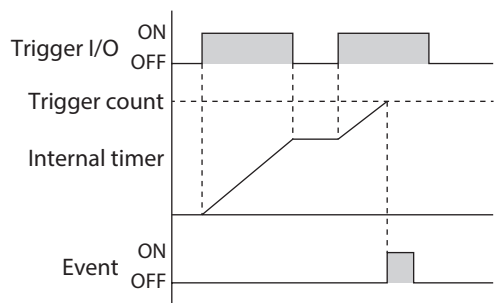

● OFF (cumulative: ms)

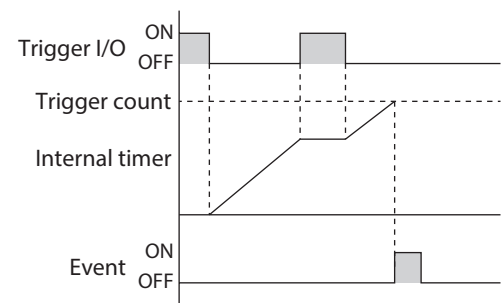

● **Example of use: When absolute positioning push-motion operation of the operation data No.0 is executed**

- Without push-motion: After the operation of No.0 is completed, the operation of No.1 is started.
(Event not generated)
- With push-motion: After the ON edge of the TLC output is detected, the operation of No.2 is started.
(Low event generated)

Setting the operation data

	Operation type	Position [step]	Operating velocity [r/min]	Acceleration time [ms]	Deceleration time [ms]
No.0	Absolute positioning push-motion	2000	30	1000	1000
No.1	Continuous operation (speed control)	0	1000	500	500
No.2	Absolute positioning	100	1000	500	500

	Torque limiting value [%]	Drive-complete delay time [ms]	Link	Next data number	Area offset	Area width
No.0	100.0	0	Automatic sequential	↓ (+1)	0	-1
No.1	100.0	0	No link	↓ (+1)	0	-1
No.2	100.0	0	No link	↓ (+1)	0	-1

	Loop count	Loop offset [step]	Loop end point	(Low) I/O event number	(Middle) I/O event number	(High) I/O event number
No.0	0	0	-	0	-	-
No.1	0	0	-	-	-	-
No.2	0	0	-	-	-	-

Operation I/O event setting

	Link	Next data number	Dwell [ms]	Event trigger I/O	Event trigger type	Event trigger counter
No.0	Automatic sequential	2	0	TLC	ON (form: positive edge ↑)	1

Operation example

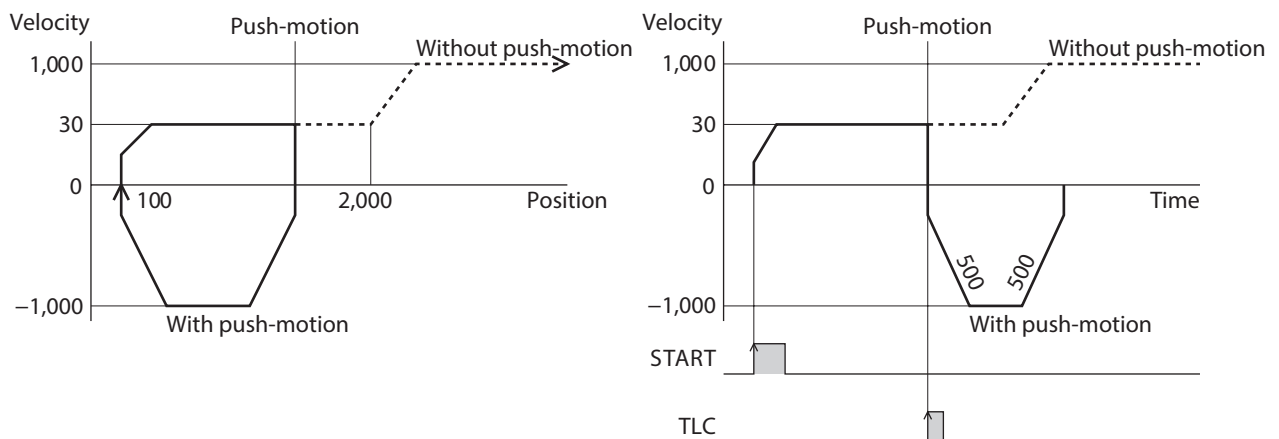

6 FW/RV operation

FW/RV operation is an operating method that turns a specific input signal ON to execute an operation corresponding to the signal. FW/RV operation includes JOG operation, inching operation, and continuous operation. The travel amount, operating velocity, acceleration/deceleration rate, etc. for each operation are set with parameters.

6-1 Types of FW/RV operation

■ JOG operation

JOG operation is FW/RV operation that uses parameters specific to JOG.

● JOG operation

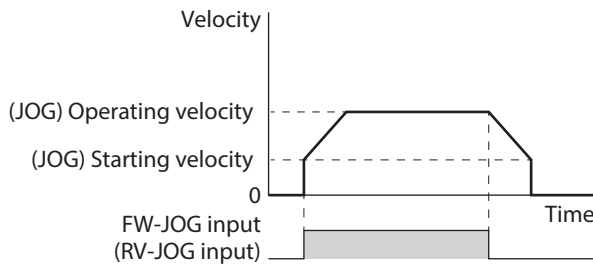

● High-speed JOG operation

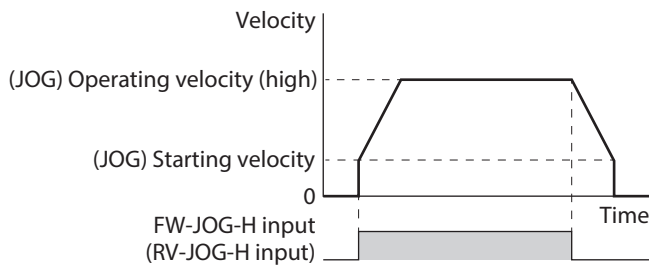

● Inching operation

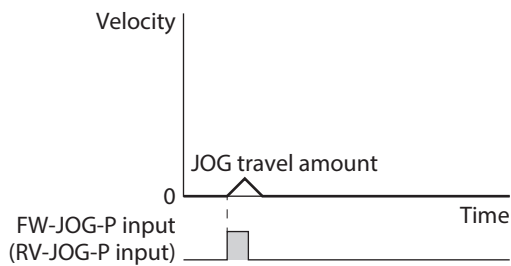

■ Continuous operation

Continuous operation is FW/RV operation that uses "Operating velocity," "Acceleration rate," "Deceleration rate," "Acceleration time," "Deceleration time," and "Torque limiting value" of operation data.

● Continuous operation (position control)

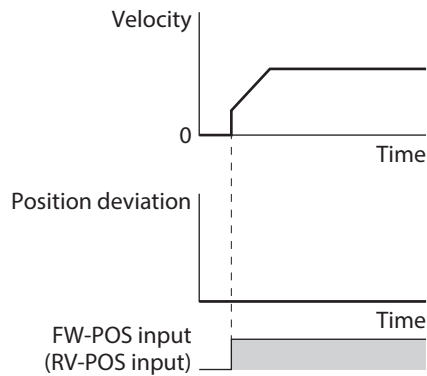

● Continuous operation (speed control)

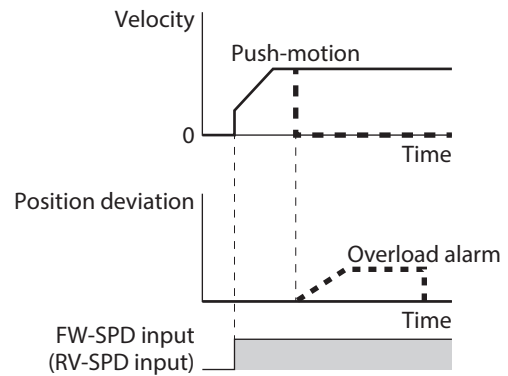

● Continuous operation (push-motion)

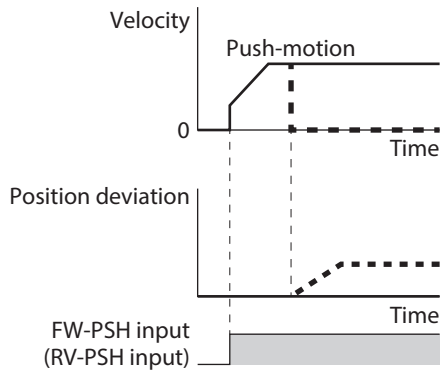

Note

- Link of operation data, loop function, and event jump function cannot be used in FW/RV operation. To link operation data, use stored data operation.
- When combined with a gear, do not perform operation that continues pressing to a load.
- When combined with a gear, set the "JOG starting speed" parameter so that the motor shaft speed is 300 r/min or lower.

■ Related parameters

Parameter name	Description	Initial setting	
		Initial value	Unit
FW/RV operation control mode setting *	Selects the control mode in FW/RV operation. [Setting range] 0: Normal 1: Motion extension	1	–

* It is effective for the driver version 3.00 or later.

memo

Refer to p.66 for the motion extension mode.

6-2 JOG operation

In JOG operation, the motor operates continuously in one direction while the FW-JOG input or the RV-JOG input is being ON. If the signal having input is turned OFF, the motor decelerates to a stop. The motor operation can be stopped by inputting the operation stop signal.

If both the FW-JOG input and the RV-JOG input are turned ON during JOG operation, the motor decelerates to a stop.

■ Operation example

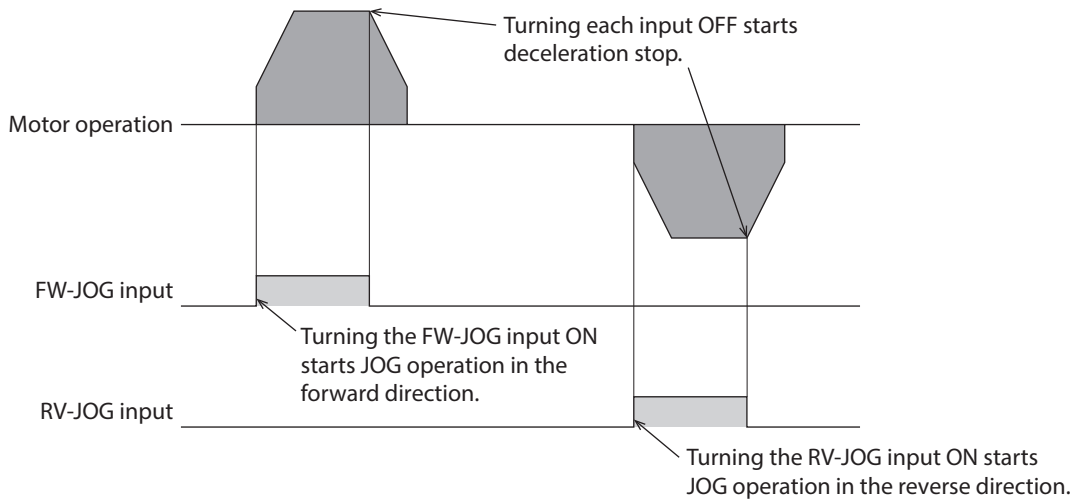

Related parameters

Parameter name	Description	Initial setting	
		Initial value	Unit
JOG/HOME command filter time constant	Sets the time constant for the command filter. [Setting range] 1 to 200 ms	1	ms
JOG/HOME Torque limit value	Sets the torque limiting value. [Setting range] 0 to 10,000 (1=0.1%) *1	10,000	1=0.1%
(JOG) Operating velocity	Sets the operating velocity for JOG operation and inching operation. [Setting range] 1 to 4,000,000 (User-defined velocity unit)	100	r/min
(JOG) Acceleration/deceleration	Sets the acceleration/deceleration rate or the acceleration/deceleration time. [Setting range] 1 to 1,000,000,000 (User-defined acceleration/deceleration unit)	1,000	ms
(JOG) Starting velocity	Sets the starting velocity. *2 [Setting range] 0 to 4,000,000 (User-defined velocity unit)	0	r/min

*1 The maximum torque limiting value varies depending on the motor. Refer to p.39 for the maximum value of each motor.

*2 When combined with a gear, set the "JOG starting speed" parameter so that the motor shaft speed is 300 r/min or lower.

■ **Timing chart**

1. Check the RDY-FWRV-OPE output is being ON.
2. Turn the FW-JOG input (or RV-JOG input) ON.
The RDY-FWRV-OPE output is turned OFF and the MOVE output is turned ON, and the motor starts operation.
3. Turn the FW-JOG input (or RV-JOG input) OFF.
4. When the motor stops, the RDY-FWRV-OPE output is turned ON and the MOVE output is turned OFF.

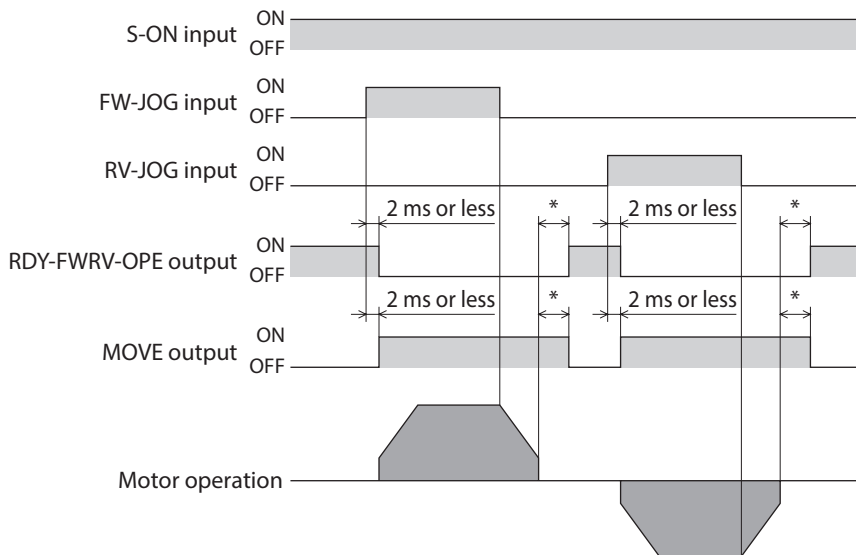
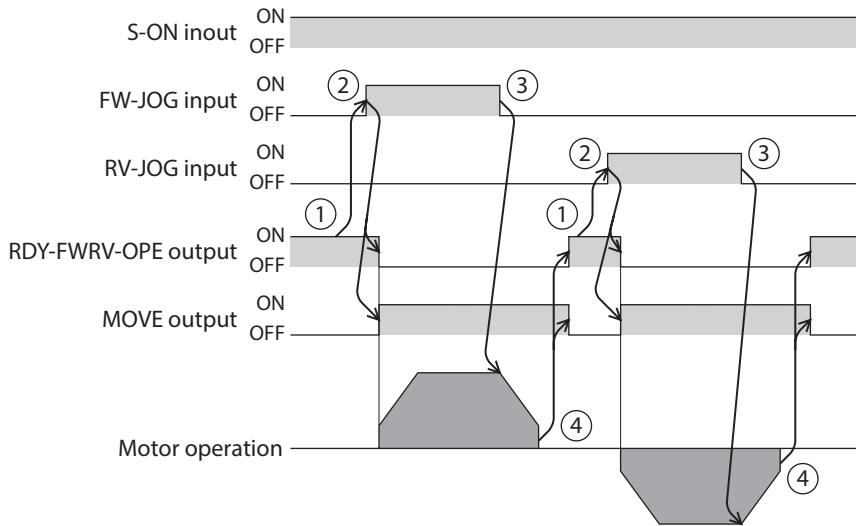

* It varies depending on the load, operating velocity, speed filter, etc.

6-3 High-speed JOG operation

In high-speed JOG operation, the motor operates continuously in one direction while the FW-JOG-H input or the RV-JOG-H input is being ON. If the signal having input is turned OFF, the motor decelerates to a stop. The motor operation can be stopped by inputting the operation stop signal. If both the FW-JOG input and the RV-JOG input are turned ON during JOG operation, the motor decelerates to a stop.

■ Operation example

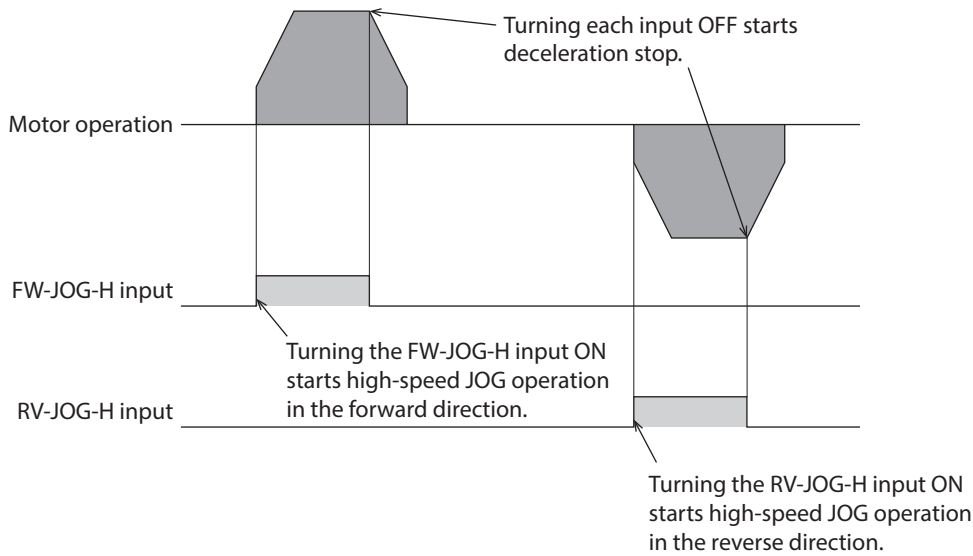

Related parameters

Parameter name	Description	Initial setting	
		Initial value	Unit
JOG/HOME command filter time constant	Sets the time constant for the command filter. [Setting range] 1 to 200 ms	1	ms
JOG/HOME Torque limit value	Sets the torque limiting value. [Setting range] 0 to 10,000 (1=0.1%) *1	10,000	1=0.1%
(JOG) Operating velocity (high)	Sets the operating velocity for high-speed JOG operation. [Setting range] 1 to 4,000,000 (User-defined velocity unit)	500	r/min
(JOG) Acceleration/deceleration	Sets the acceleration/deceleration rate or the acceleration/deceleration time. [Setting range] 1 to 1,000,000,000 (User-defined acceleration/deceleration unit)	1000	ms
(JOG) Starting velocity	Sets the starting velocity. *2 [Setting range] 0 to 4,000,000 (User-defined velocity unit)	0	r/min

*1 The maximum torque limiting value varies depending on the motor. Refer to p.39 for the maximum value of each motor.

*2 When combined with a gear, set the "JOG starting speed" parameter so that the motor shaft speed is 300 r/min or lower.

■ Timing chart

1. Check the RDY-FWRV-OPE output is being ON.
2. Turn the FW-JOG-H input (or RV-JOG-H input) ON.
The RDY-FWRV-OPE output is turned OFF and the MOVE output is turned ON, and the motor starts operation.
3. Turn the FW-JOG-H input (or RV-JOG-H input) OFF.
The motor starts deceleration stop.
4. When the motor stops, the RDY-FWRV-OPE output is turned ON and the MOVE output is turned OFF.

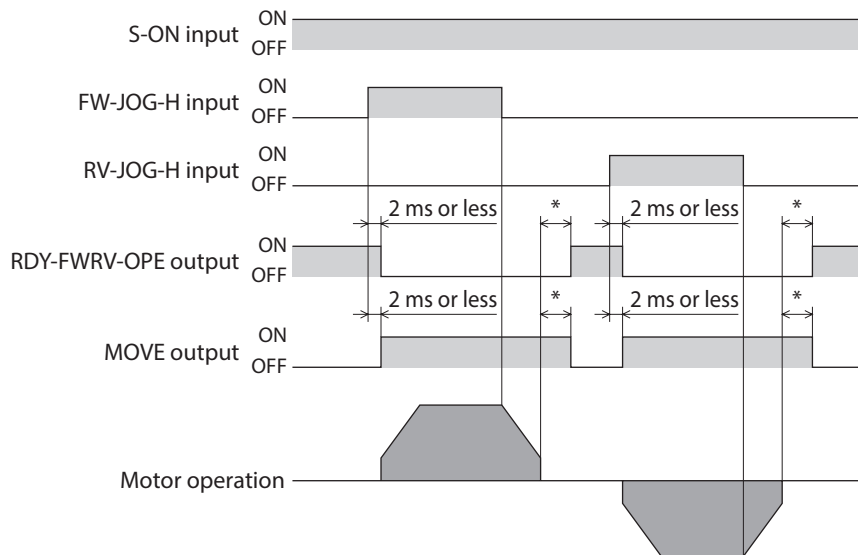
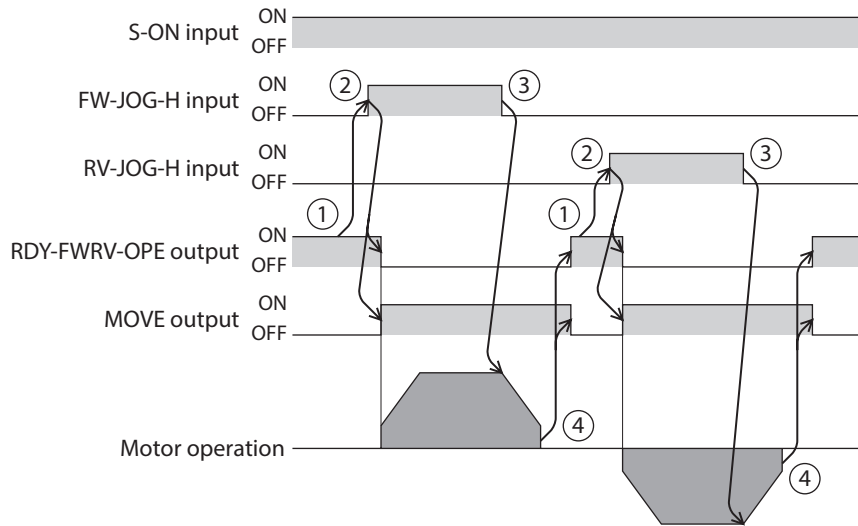

* It varies depending on the load, operating velocity, speed filter, etc.

6-4 Inching operation

In inching operation, the motor performs positioning operation when the FW-JOG-P input or the RV-JOG-P input is turned from OFF to ON. The motor stops when it rotates by the number of steps set in "(JOG) Travel amount."

■ Operation example

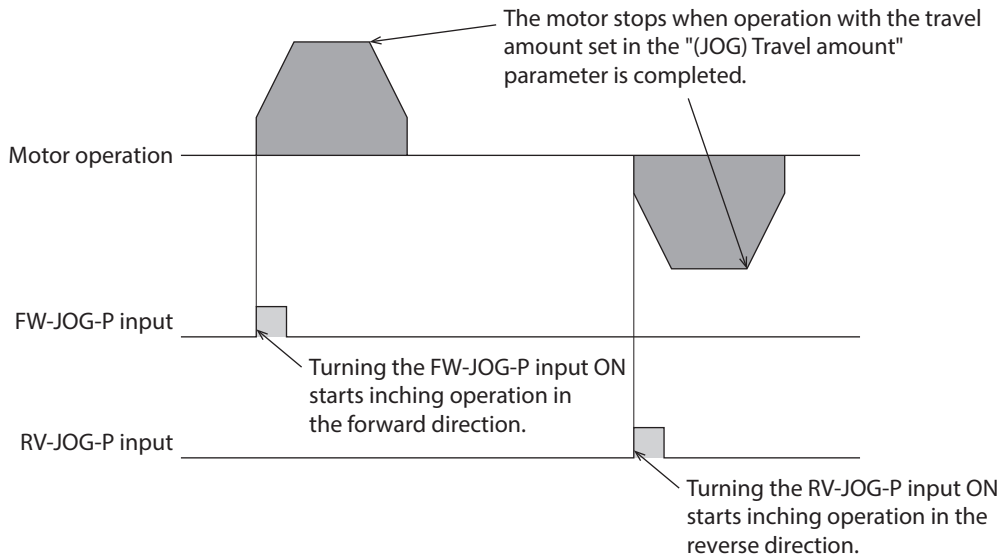

Related parameters

Parameter name	Description	Initial setting	
		Initial value	Unit
JOG/HOME command filter time constant	Sets the time constant for the command filter. [Setting range] 1 to 200 ms	1	ms
JOG/HOME Torque limit value	Sets the torque limiting value. [Setting range] 0 to 10,000 (1=0.1%) *1	10,000	1=0.1%
(JOG) Travel amount	Sets the travel amount for inching operation. [Setting range] 1 to 8,388,607 (User-defined position unit)	1	step
(JOG) Operating velocity	Sets the operating velocity for JOG operation and inching operation. [Setting range] 1 to 4,000,000 (User-defined velocity unit)	100	r/min
(JOG) Acceleration/deceleration	Sets the acceleration/deceleration rate or the acceleration/deceleration time. [Setting range] 1 to 1,000,000,000 (User-defined acceleration/deceleration unit)	1,000	ms
(JOG) Starting velocity	Sets the starting velocity. *2 [Setting range] 0 to 4,000,000 (User-defined velocity unit)	0	r/min

*1 The maximum torque limiting value varies depending on the motor. Refer to p.39 for the maximum value of each motor.

*2 When combined with a gear, set the "JOG starting speed" parameter so that the motor shaft speed is 300 r/min or lower.

■ Timing chart

1. Check the RDY-FWRV-OPE output is being ON.
2. Turn the FW-JOG-P input (or RV-JOG-P input) ON. The IN-POS output and the RDY-FWRV-OPE output are turned OFF and the MOVE output is turned ON, and the motor starts operation.
3. Check the RDY-FWRV-OPE output has been turned OFF and turn the FW-JOG-P input (or RV-JOG-P) input OFF.
4. When the motor stops, the IN-POS output and the RDY-FWRV-OPE output are turned ON and the MOVE output is turned OFF.

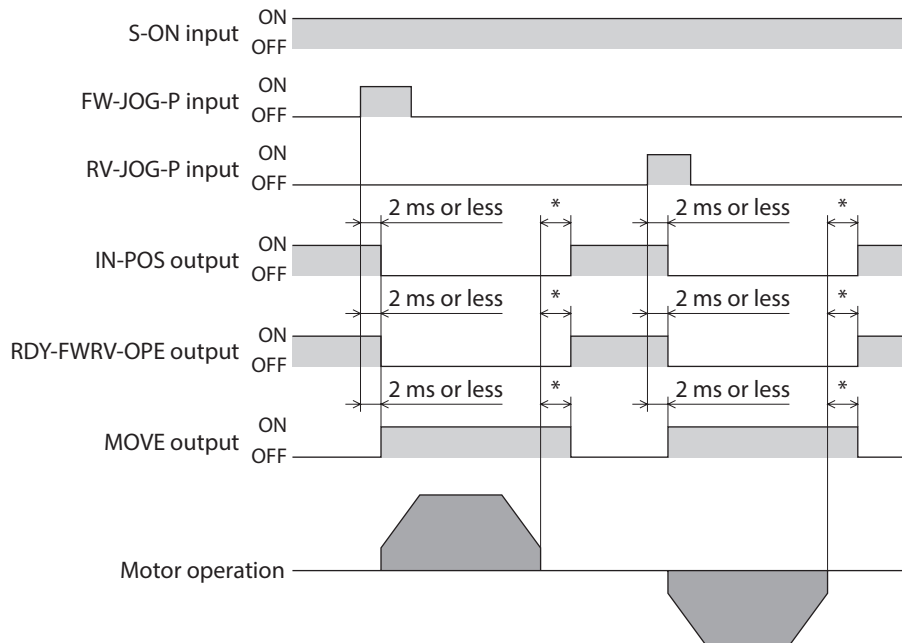
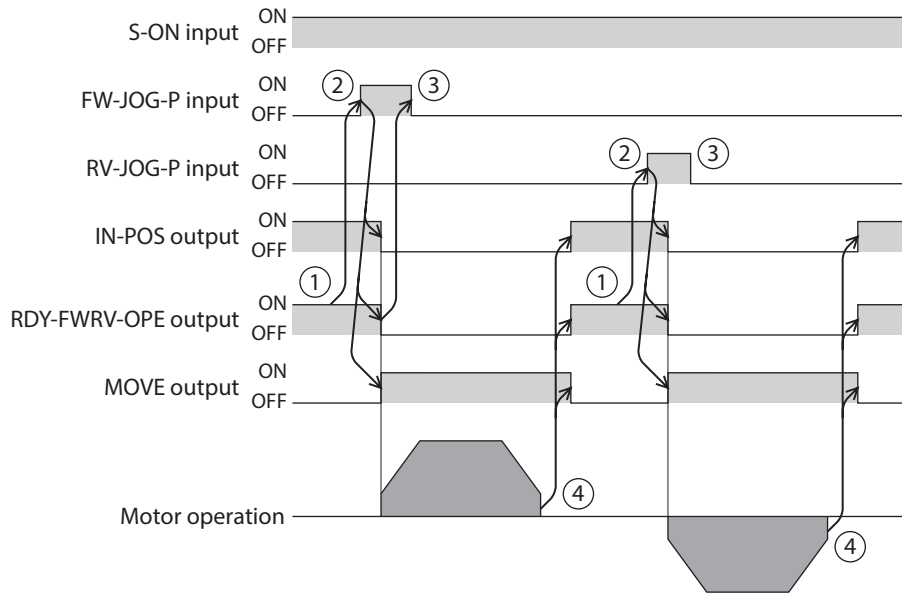

* It varies depending on the load, operating velocity, speed filter, etc.

6-5 Continuous operation (position control)

When the operation data number is selected and the FW-POS input or the RV-POS input is turned ON, continuous operation (position control) is started at the operating velocity corresponding to the operation data number selected. Turning the FW-POS input ON rotates the motor in the forward direction (FWD), and turning the RV-POS input ON rotates it in the reverse direction (RVS).

If the signal of the same rotation direction is turned ON while the motor decelerates to a stop, the motor accelerates again and continues operation.

If both the FW-POS and RV-POS inputs are turned ON, the motor decelerates to a stop.

When the operation data number is changed during continuous operation, the operating velocity is changed to that of the operation data number changed.

■ Operation example

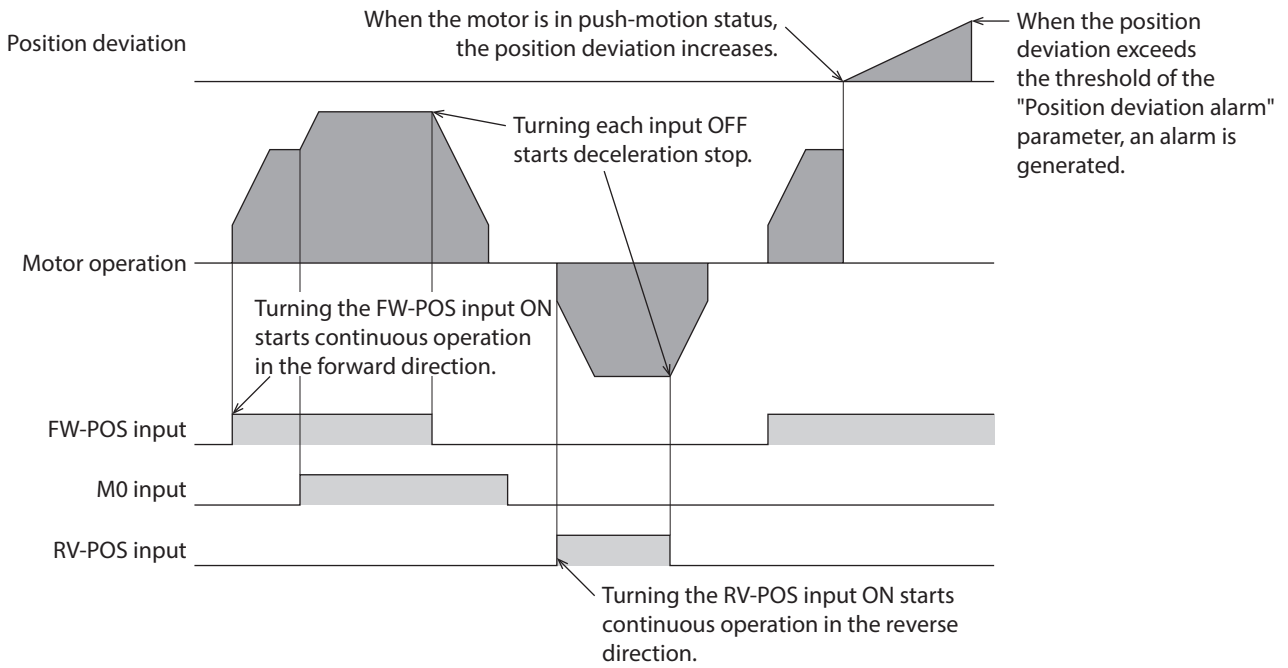

Related operation data

Name	Description	Initial setting	
		Initial value	Unit
Operating velocity	Sets the operating velocity. [Setting range] -4,000,000 to 4,000,000 (User-defined velocity unit)	0	r/min
Acceleration rate	Sets the acceleration rate. [Setting range] 1 to 1,000,000,000 ((User-defined velocity unit)/s)	1,000	(r/min)/s
Deceleration rate	Sets the deceleration rate. [Setting range] 1 to 1,000,000,000 ((User-defined velocity unit)/s)	1,000	(r/min)/s
Acceleration time	Sets the acceleration time. [Setting range] 1 to 1,000,000,000 ms	1,000	ms
Deceleration time	Sets the deceleration time. [Setting range] 1 to 1,000,000,000 ms	1,000	ms
Torque limiting value	Sets the torque limiting value. [Setting range] 0 to 10,000 (1=0.1%) *	10,000	1=0.1%

* The maximum torque limiting value varies depending on the motor. Refer to p.39 for the maximum value of each motor.

Related parameter

Parameter name	Description	Initial setting	
		Initial value	Unit
Starting velocity	Sets the starting velocity. * [Setting range] 0 to 4,000,000 (User-defined velocity unit)	0	r/min

* When combined with a gear, set the "Starting velocity" parameter so that the motor shaft speed is 300 r/min or lower.

■ **Timing chart**

1. Check the RDY-FWRV-OPE output is being ON.
2. Turn the FW-POS input (or RV-POS input) ON.
The RDY-FWRV-OPE output is turned OFF and the MOVE output is turned ON, and the motor starts operation.
3. Turn the FW-POS input (or RV-POS input) OFF.
The motor starts deceleration stop.
4. When the motor stops, the RDY-FWRV-OPE output is turned ON and the MOVE output is turned OFF.

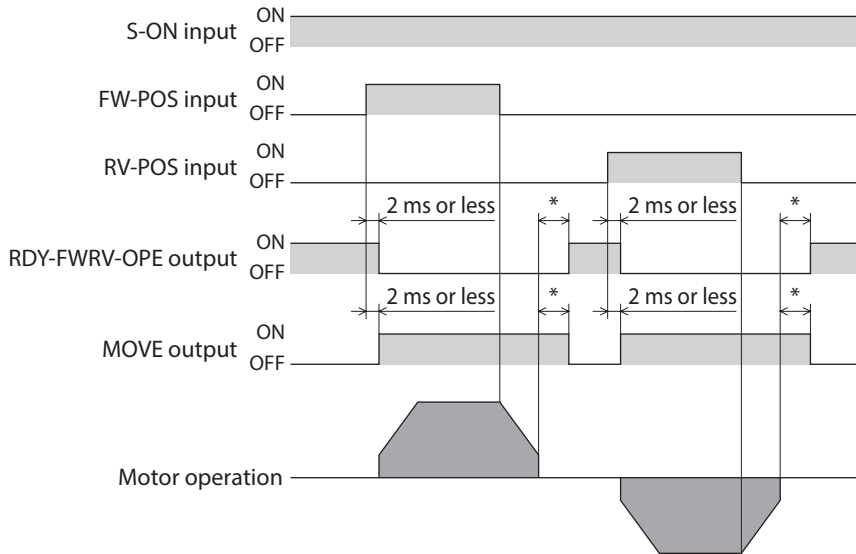
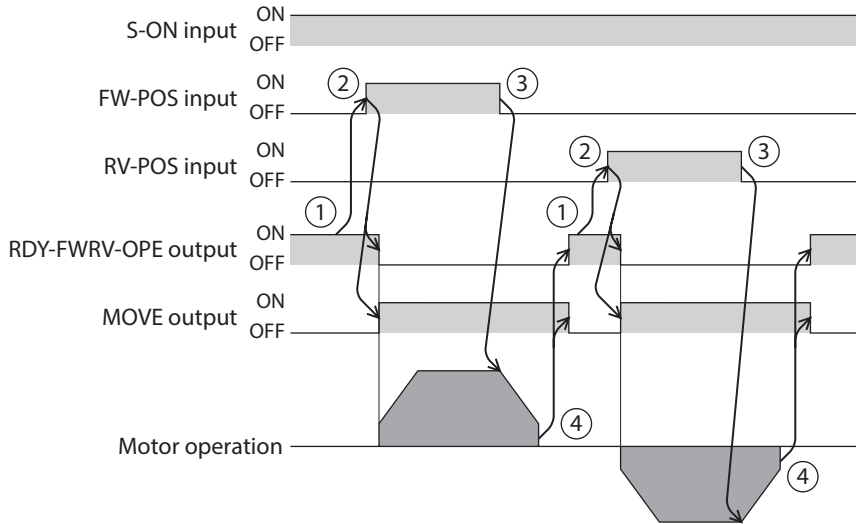

* It varies depending on the load, operating velocity, speed filter, etc.

6-6 Continuous operation (speed control)

When the operation data number is selected and the FW-SPD input or the RV-SPD input is turned ON, continuous operation (speed control) is started at the operating velocity corresponding to the operation data number selected. Turning the FW-SPD input ON rotates the motor in the forward direction (FWD) and turning the RV-SPD input ON rotates the motor in the reverse direction (RVS).

If the signal of the same rotation direction is turned ON while the motor decelerates to a stop, the motor accelerates again and continues operation.

If both the FW-SPD and RV-SPD inputs are turned ON, the motor decelerates to a stop.

When the operation data number is changed during continuous operation, the operating velocity is changed to that of the operation data number changed.

■ Operation example

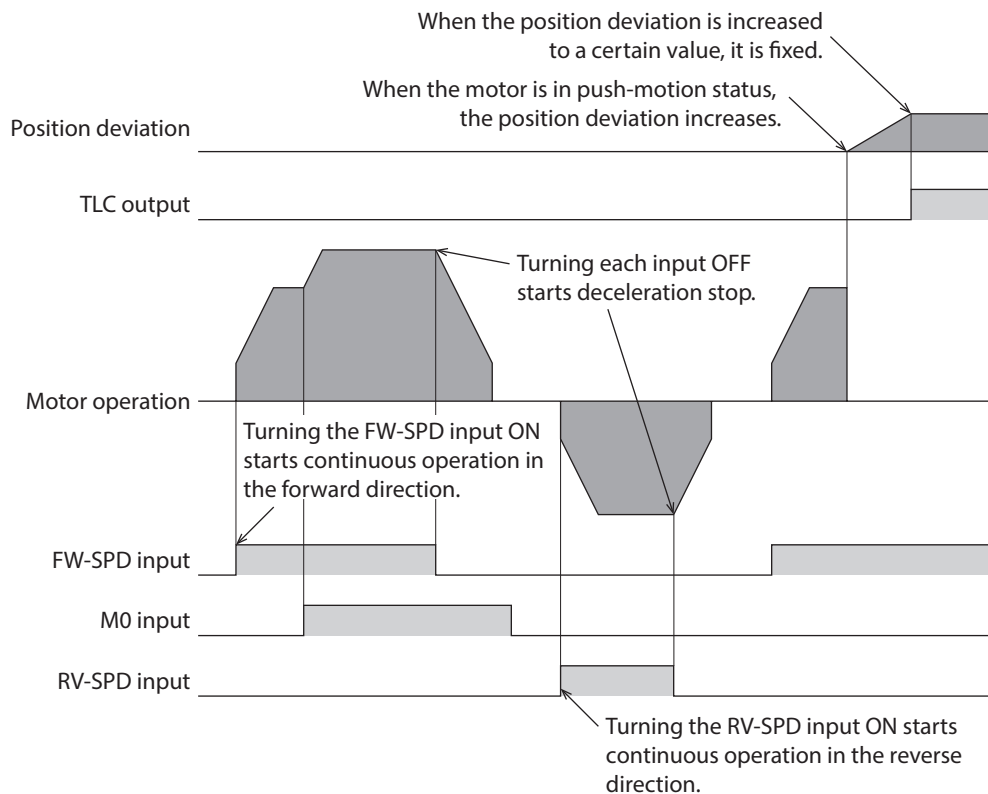

Related operation data

Name	Description	Initial setting	
		Initial value	Unit
Operating velocity	Sets the operating velocity. [Setting range] -4,000,000 to 4,000,000 (User-defined velocity unit)	0	r/min
Acceleration rate	Sets the acceleration rate. [Setting range] 1 to 1,000,000,000 ((User-defined velocity unit)/s)	1,000	(r/min)/s
Deceleration rate	Sets the deceleration rate. [Setting range] 1 to 1,000,000,000 ((User-defined velocity unit)/s)	1,000	(r/min)/s
Acceleration time	Sets the acceleration time. [Setting range] 1 to 1,000,000,000 ms	1,000	ms
Deceleration time	Sets the deceleration time. [Setting range] 1 to 1,000,000,000 ms	1,000	ms
Torque limiting value	Sets the torque limiting value. [Setting range] 0 to 10,000 (1=0.1%) *	10,000	1=0.1%

* The maximum torque limiting value varies depending on the motor. Refer to p.39 for the maximum value of each motor.

Related parameter

Parameter name	Description	Initial setting	
		Initial value	Unit
Starting velocity	Sets the starting velocity. * [Setting range] 0 to 4,000,000 (User-defined velocity unit)	0	r/min

* When combined with a gear, set the "Starting velocity" parameter so that the motor shaft speed is 300 r/min or lower.

■ Timing chart

1. Check the RDY-FWRV-OPE output is being ON.
2. Turn the FW-SPD input (or RV-SPD input) ON.
The RDY-FWRV-OPE output is turned OFF and the MOVE output is turned ON, and the motor starts operation.
3. Turn the FW-SPD input (or RV-SPD input) OFF.
The motor starts deceleration stop.
4. When the motor stops, the RDY-FWRV-OPE output is turned ON and the MOVE output is turned OFF.

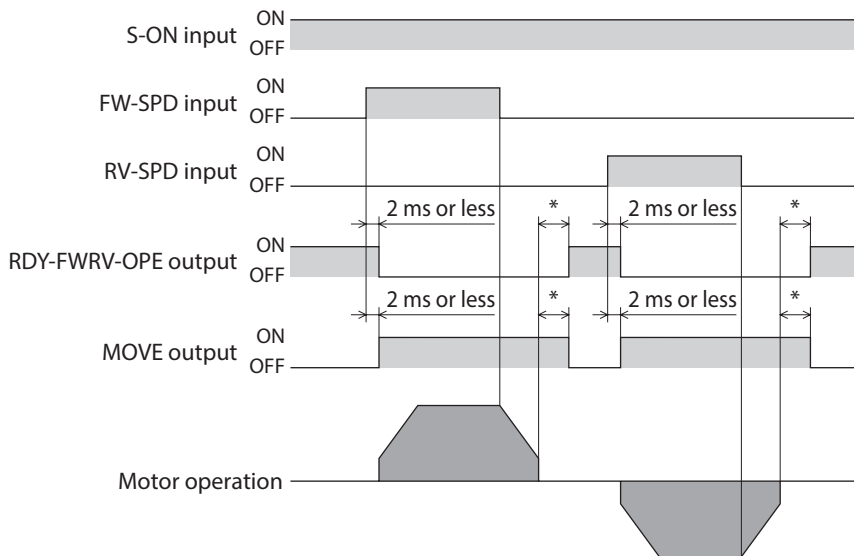
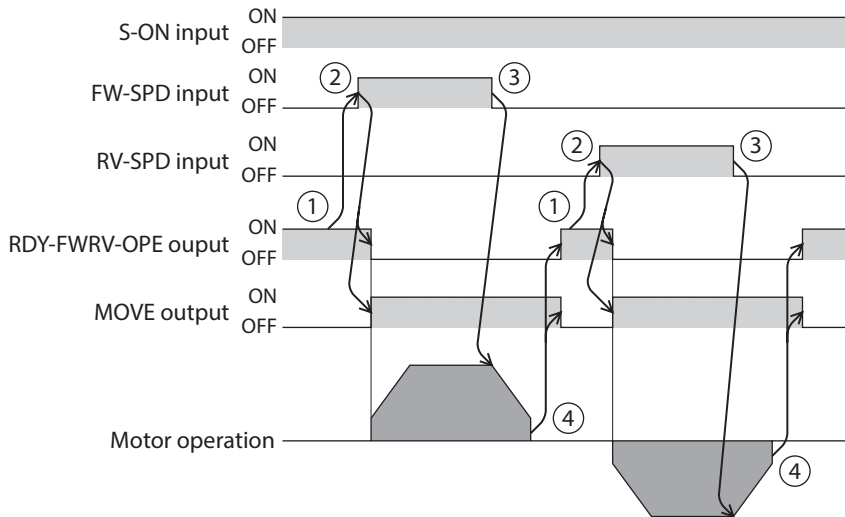

* It varies depending on the load, operating velocity, speed filter, etc.

6-7 Continuous operation (push-motion)

When the operation data number is selected and the FW-PSH input or the RV-PSH input is turned ON, continuous operation (push-motion) is started at the operating velocity corresponding to the operation data number selected. Turning the FW-PSH input ON rotates the motor in the forward direction (FWD) and turning the RV-PSH input ON rotates the motor in the reverse direction (RVS).

If the signal of the same rotation direction is turned ON while the motor decelerates to a stop, the motor accelerates again and continues operation.

If both the FW-PSH and RV-PSH inputs are turned ON, the motor decelerates to a stop.

When the operation data number is changed during continuous operation, the operating velocity is changed to that of the operation data number changed.

- Note**
- When combined with a gear, do not perform operation that continues pressing to a load.
 - If a value larger than 100.0% is set to the torque limiting value, an alarm of "Operation data error" is generated.

■ Operation example

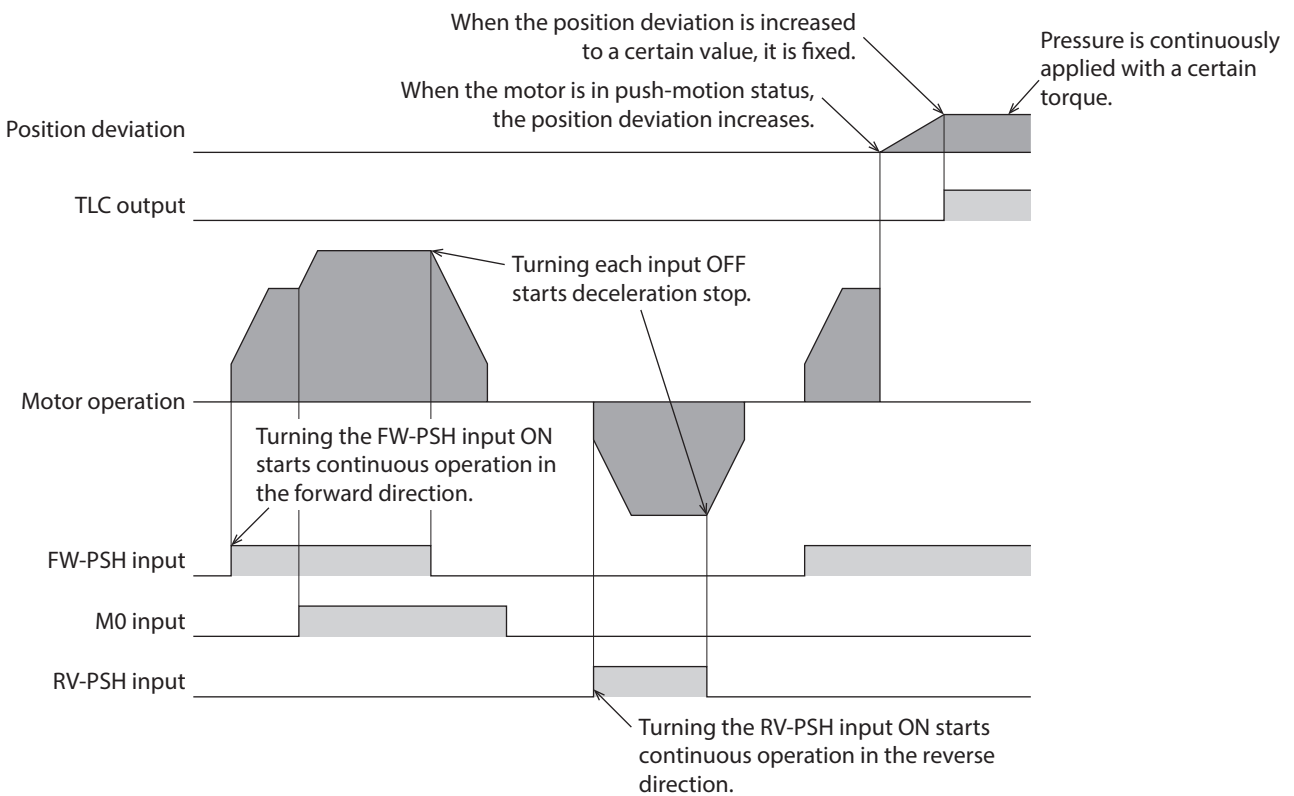

Related operation data

Name	Description	Initial setting	
		Initial value	Unit
Operating velocity	Sets the operating velocity. [Setting range] -4,000,000 to 4,000,000 (User-defined velocity unit)	0	r/min
Acceleration rate	Sets the acceleration rate. [Setting range] 1 to 1,000,000,000 ((User-defined velocity unit)/s)	1,000	(r/min)/s
Deceleration rate	Sets the deceleration rate. [Setting range] 1 to 1,000,000,000 ((User-defined velocity unit)/s)	1,000	(r/min)/s
Acceleration time	Sets the acceleration time. [Setting range] 1 to 1,000,000,000 ms	1,000	ms
Deceleration time	Sets the deceleration time. [Setting range] 1 to 1,000,000,000 ms	1,000	ms
Torque limiting value	Sets the torque limiting value. [Setting range] 0 to 10,000 (1=0.1%) *	10,000	1=0.1%

* The maximum torque limiting value varies depending on the motor. Refer to p.39 for the maximum value of each motor.

Related parameter

Parameter name	Description	Initial setting	
		Initial value	Unit
Starting velocity	Sets the starting velocity. * [Setting range] 0 to 4,000,000 (User-defined velocity unit)	0	r/min

* When combined with a gear, set the "Starting velocity" parameter so that the motor shaft speed is 300 r/min or lower.

■ **Timing chart**

1. Check the RDY-FWRV-OPE output is being ON.
2. Turn the FW-PSH input (or RV-PSH input) ON.
The RDY-FWRV-OPE output is turned OFF and the MOVE output is turned ON, and the motor starts operation.
3. Turn the FW-PSH input (or RV-PSH input) OFF.
The motor starts deceleration stop.
4. When the motor stops, the RDY-FWRV-OPE output is turned ON and the MOVE output is turned OFF.

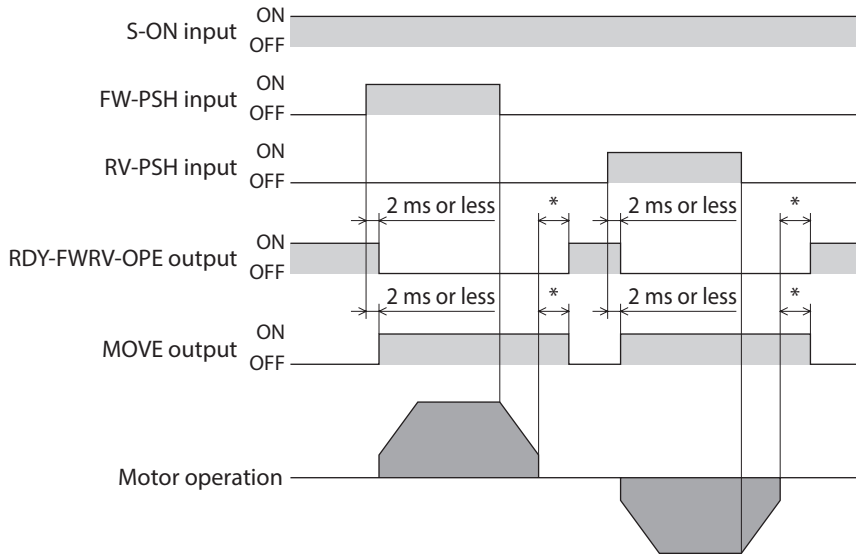
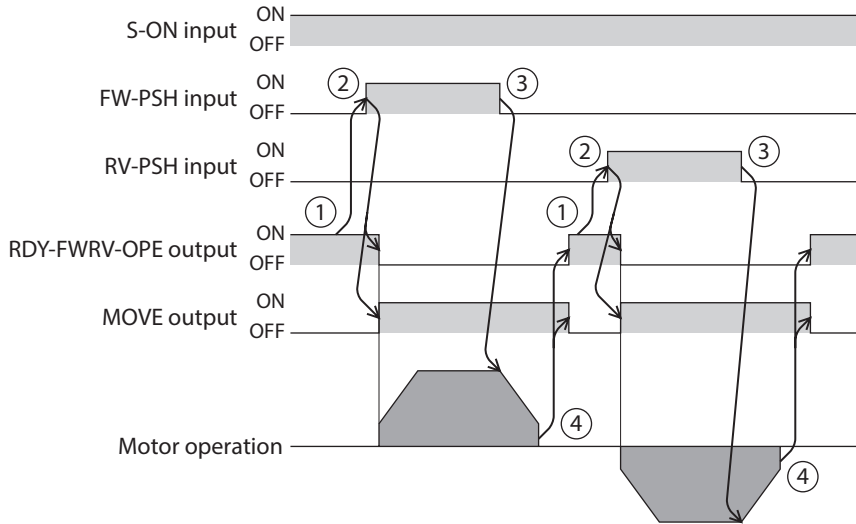

* It varies depending on the load, operating velocity, speed filter, etc.

7 I/O homing operation

Homing operation is an operation that detects the home using external sensors.

It is executed to return from the present position to the home when the power supply is turned on or positioning operation is completed.

There are four types of homing operation shown below.

Item	Description	Features
2-sensor mode	When the limit sensor is detected, the motor rotates in the reverse direction and pull out of the limit sensor. After pulling out of the limit sensor, the motor rotates according to the value set in the "(HOME) Backward steps in 2 sensor homing" parameter and stops. The stop position is set as the home.	<ul style="list-style-type: none"> • Two sensors are required externally. • The operating velocity is at a low rate ((HOME) Starting velocity).
3-sensor mode	When the limit sensor is detected, the motor rotates in the reverse direction and pull out of the limit sensor. After that, it stops when the ON edge of the HOME sensor is detected. The stop position is set as the home.	<ul style="list-style-type: none"> • Three sensors are required externally. *2 • The operating velocity is at a high rate ((HOME) Operating velocity).
One-way rotation mode	The motor stops when the ON edge of the HOME sensor is detected. After that, until the OFF edge of the HOME sensor is detected, it pulls out of the sensor according to the velocity set in the "(HOME) Last velocity" parameter. After pulling out of the HOME sensor, the motor rotates according to the value set in the "(HOME) Operating amount in unidirectional homing" parameter and stops. The stop position is set as the home.	<ul style="list-style-type: none"> • One external sensor is required. • The operating velocity is at a high rate ((HOME) Operating velocity). • Not rotate in the reverse direction
Push-motion mode *1	The motor rotates in the reverse direction when a mechanism installed to the motor presses against a mechanical stopper, etc. After that, it rotates according to the value set in the "(HOME) Backward steps after first entry in push-homing" parameter and reverses, and then operates at the "(HOME) Last velocity." When a mechanism installed to the motor presses against a mechanical stopper or others, it rotates in the reverse direction and stops after rotating according to the value set in the "(HOME) Backward steps in push-homing" parameter. The stop position is set as the home.	<ul style="list-style-type: none"> • An external sensor is not required. • The operating velocity is at a high rate ((HOME) Operating velocity).

*1 When combined with a gear, do not perform push-motion homing operation.

*2 For a rotating mechanism, the home can be detected even using one external sensor.



Signals of external sensors required for homing operation are not assigned at the time of shipment. Assign signals before executing homing operation.

Explanation of code

- VR: (HOME) Operating velocity
- VS: (HOME) Starting velocity
- VL: (HOME) Last velocity
- ---: Orbit when (HOME) Travel amount of additional operation after homing is set

• 2-sensor mode

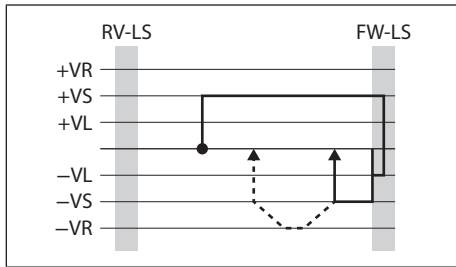

• 3-sensor mode

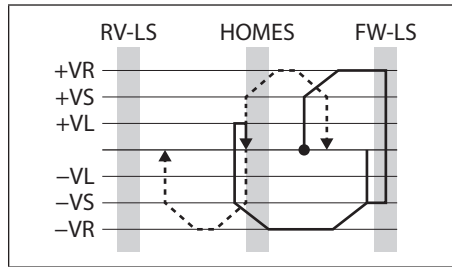

• One-way rotation mode

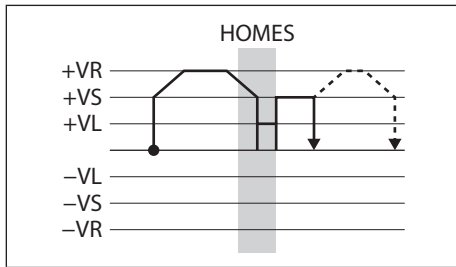

• Push-motion mode

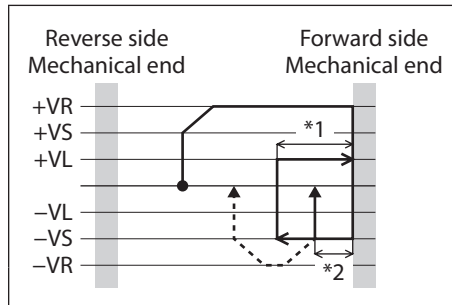

*1 Depending on "(HOME) Backward steps after first entry in push-homing" parameter

*2 Depending on "(HOME) Backward steps in push-homing" parameter



When combined with a gear, set the "(HOME) Starting velocity" parameter and the "(HOME) Last velocity" parameter so that the motor shaft speed is 300 r/min or lower.

Related parameters

Parameter name	Description	Initial setting	
		Initial value	Unit
JOG/HOME command filter time constant	Sets the time constant for the command filter. [Setting range] 1 to 200 ms	1	ms
JOG/HOME Torque limit value	Sets the torque limiting value. [Setting range] 0 to 10,000 (1=0.1%) *1	10,000	1=0.1%
(HOME) Homing mode	Sets the homing method. [Setting range] 0: 2 sensors 1: 3 sensors 2: One-way rotation 3: Push	1	-
(HOME) Starting direction	Sets the starting direction for home detection. [Setting range] 0: Negative side 1: Positive side	1	-
(HOME) Acceleration/ deceleration	Sets the acceleration/deceleration rate or the acceleration/ deceleration time. [Setting range] 1 to 1,000,000,000 (User-defined acceleration/detection unit)	1,000	ms

Parameter name	Description	Initial setting	
		Initial value	Unit
(HOME) Starting velocity	Sets the starting velocity. *2 [Setting range] 1 to 4,000,000 (User-defined velocity unit)	30	r/min
(HOME) Operating velocity	Sets the operating velocity. [Setting range] 1 to 4,000,000 (User-defined velocity unit)	60	r/min
(HOME) Last velocity	Sets the operating velocity when finally positioning with the home. *2 [Setting range] 1 to 4,000,000 (User-defined velocity unit)	30	r/min
(HOME) Backward steps in 2 sensor homing	Sets the amount of backward steps after homing operation in 2-sensor mode. [Setting range] 0 to 8,388,607 (User-defined position unit)	18,000	step
(HOME) Operating amount in unidirectional homing	Sets the operating amount after homing operation in one-way rotation mode. [Setting range] 0 to 8,388,607 (User-defined position unit)	18,000	step
(HOME) Torque limit value for push-homing	Sets the torque limiting value for push-motion homing. [Setting range] 0 to 1,000 (1=0.1%) *1	1000	1=0.1%
(HOME) Backward steps after first entry in push-homing	Sets the amount of backward steps after first detecting the mechanical end in push-motion homing operation. [Setting range] 0 to 8,388,607 (User-defined position unit)	0	step
(HOME) Pushing time in push-homing	Sets the generation time of the TLC output that judges the completion of push motion. [Setting range] 1 to 65,535 ms	200	ms
(HOME) Backward steps in push-homing	Sets the amount of backward steps after fixing the mechanical end position in push-motion homing operation. [Setting range] 0 to 8,388,607 (User-defined position unit)	18,000	step
Home offset	Sets the amount of offset from the home when homing operation is completed or P-PRESET is executed. [Setting range] -2,147,483,648 to 2,147,483,647 (User-defined position unit)	0	step

*1 The maximum torque limiting value varies depending on the motor. Refer to p.39 for the maximum value of each motor.

*2 When combined with a gear, set the "(HOME) Starting velocity" parameter and the "(HOME) Last velocity" parameter so that the motor shaft speed is 300 r/min or lower.



- The ABSPEN output is turned OFF since the coordinates are not fixed during homing operation.
- In homing operation, the preset (P-PRESET) is executed after homing additional operation is completed to set the coordinates. Therefore, the machine coordinates of the home position are depended on the "Home offset" parameter.

■ Additional function

● Homing additional operation

This is a function that performs positioning operation of the value set in the "(HOME) Travel amount of additional operation after Homing" parameter after homing operation and sets the stopped position as the home.

● External sensor (signal) detection

Using the SLIT input or the ZSG-N signal concurrently with homing operation can detect the home more accurately.

Related parameters

Parameter name	Description	Initial setting	
		Initial value	Unit
(HOME) SLIT detection	Sets whether to use the SLIT input together when returning to the home. [Setting range] 0: Disable 1: Enable	0	–
(HOME) ZSG signal detection	Sets whether to use the ZSG-N signal together when returning to the home. [Setting range] 0: Disable 2: ZSG	0	–
(HOME) Travel amount of additional operation after homing	Sets the travel amount for homing additional operation. [Setting range] –2,147,483,647 to 2,147,483,647 (User-defined position unit)	0	step

■ Timing chart (3-sensor mode)

1. Check the RDY-HOME-OPE output is being ON.
2. Turn the HOME input ON.
3. The RDY-HOME-OPE output is turned OFF and the MOVE output is turned ON, and homing operation is started.
4. Check the RDY-HOME-OPE output has been turned OFF and turn the HOME input OFF.
5. The HOMES input is turned ON and the homing operation is completed.
The HOME-END output and the RDY-HOME-OPE output are turned ON, and the MOVE output and the OPE-BSY output are turned OFF.

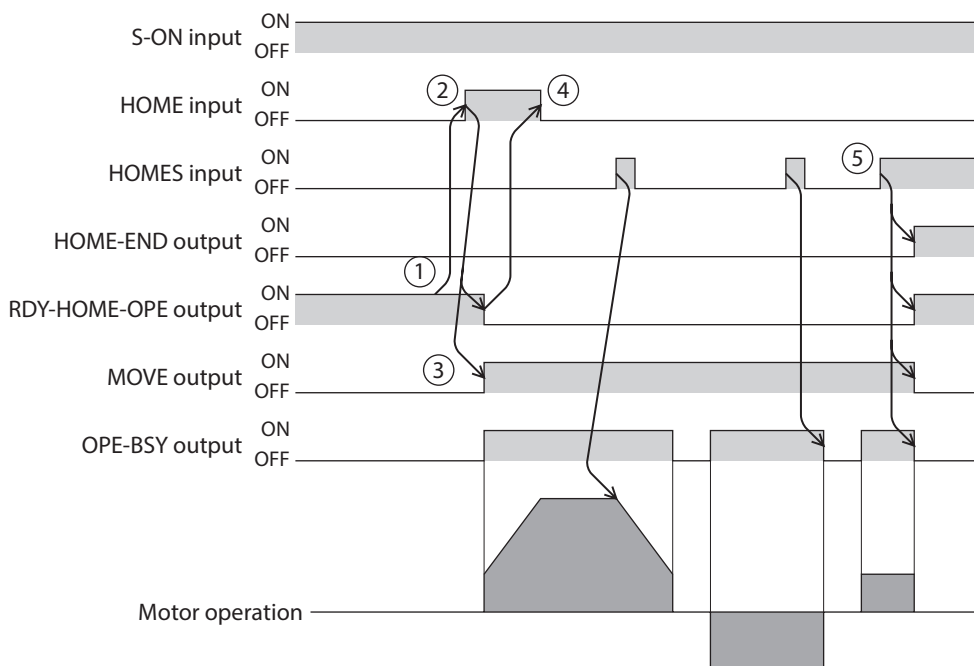

7-1 3-sensor mode

When the limit sensor is detected during operation, the motor rotates in the reverse direction and pulls out of the limit sensor. The motor operates at the "(HOME) Operating velocity" and stops when the ON edge of the HOME sensor is detected. The stop position is set as the home.

Explanation of code

- VR: (HOME) Operating velocity
- VS: (HOME) Starting velocity
- VL: (HOME) Last velocity
- ---: Orbit when (HOME) Travel amount of additional operation after homing is set

Starting position of homing operation	Starting direction of homing operation: Positive direction	Starting direction of homing operation: Negative direction
RV-LS		
FW-LS		
HOMES		
Between HOMES and RV-LS		
Between HOMES and FW-LS		



When combined with a gear, set the "(HOME) Starting velocity" parameter and the "(HOME) Last velocity" parameter so that the motor shaft speed is 300 r/min or lower.

■ **When using the HOME sensor only (rotating machine etc.)**

If the limit sensor is not used, in case of a rotating mechanism for example, the sequence is as follows.

Starting position of homing operation	Starting direction of homing operation: Positive direction	Starting direction of homing operation: Negative direction
HOMES	<p style="text-align: center;">HOMES</p> <p>+VR +VS +VL -VL -VS -VR</p>	<p style="text-align: center;">HOMES</p> <p>+VR +VS +VL -VL -VS -VR</p>
Other than HOMES	<p style="text-align: center;">HOMES</p> <p>+VR +VS +VL -VL -VS -VR</p>	<p style="text-align: center;">HOMES</p> <p>+VR +VS +VL -VL -VS -VR</p>

Note Depending on the value set in the "(HOME) Acceleration/deceleration" parameter, the motor may decelerate to a stop in excess of the HOME sensor after the HOME sensor was detected. There is a risk of contact if the distance between the mechanical end and the HOME sensor is close, so provide enough distance between them.

■ **When the SLIT input and/or the ZSG signal are used concurrently**

Even after homing operation is completed, operation is continued until an external signal is detected. If an external signal is detected while the HOME sensor is ON, homing operation is completed.

Home detection signal	Starting direction of homing operation: Positive direction	Starting direction of homing operation: Negative direction
SLIT input		
ZSG signal		
SLIT input and ZSG signal		

7-2 2-sensor mode

The motor operates in the "(HOME) Starting direction" at the "(HOME) Starting velocity." When the limit sensor is detected, the motor rotates in the reverse direction and pulls out of the limit sensor at the "(HOME) Last velocity." After pulling out of the limit sensor, the motor operates according to the value set in the "(HOME) Backward steps in 2 sensor homing" at the starting velocity and stops. The stop position is set as the home.

Explanation of code

- VR: (HOME) Operating velocity
- VS: (HOME) Starting velocity
- VL: (HOME) Last velocity
- ---: Orbit when (HOME) Travel amount of additional operation after homing is set

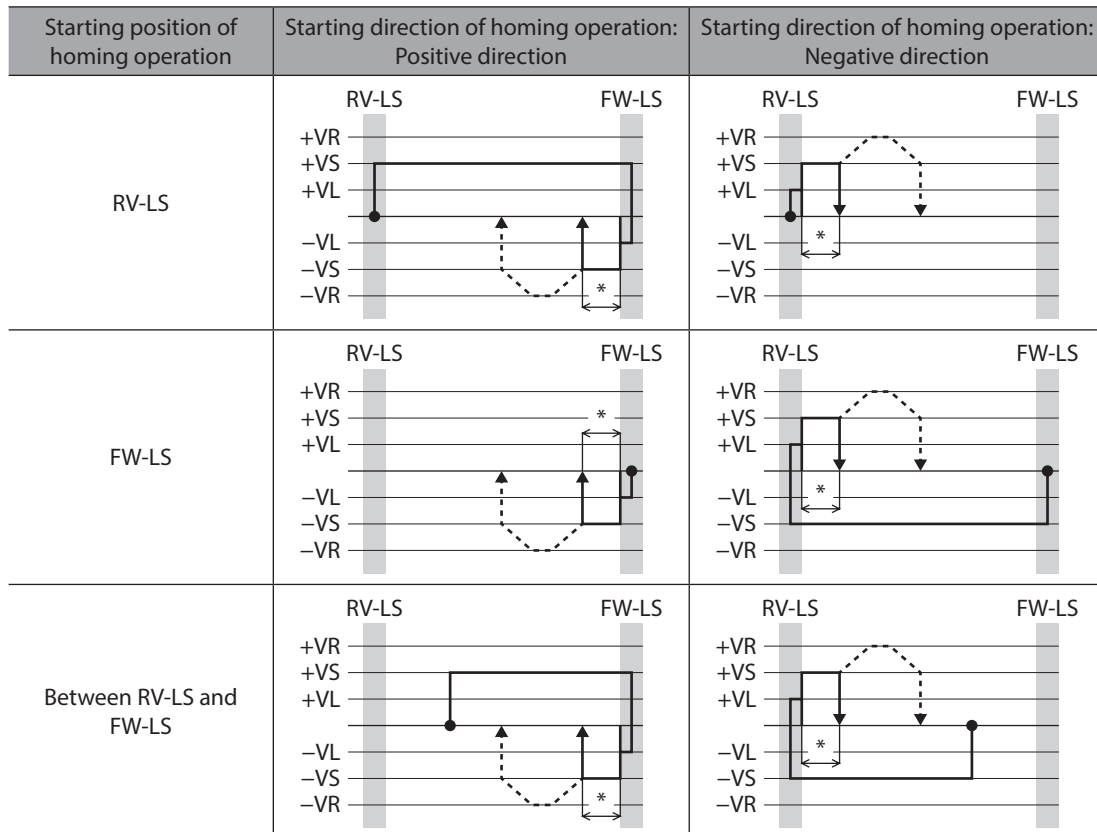

* The motor pulls out of the limit sensor, and rotates according to the value set in the "(HOME) Backward steps in 2 sensor homing."

Note When combined with a gear, set the "(HOME) Starting velocity" parameter and the "(HOME) Last velocity" parameter so that the motor shaft speed is 300 r/min or lower.

■ When the SLIT input and/or ZSG signal are used concurrently

Even after homing operation is completed, operation is continued until an external signal is detected. If an external signal is detected, homing operation is completed.

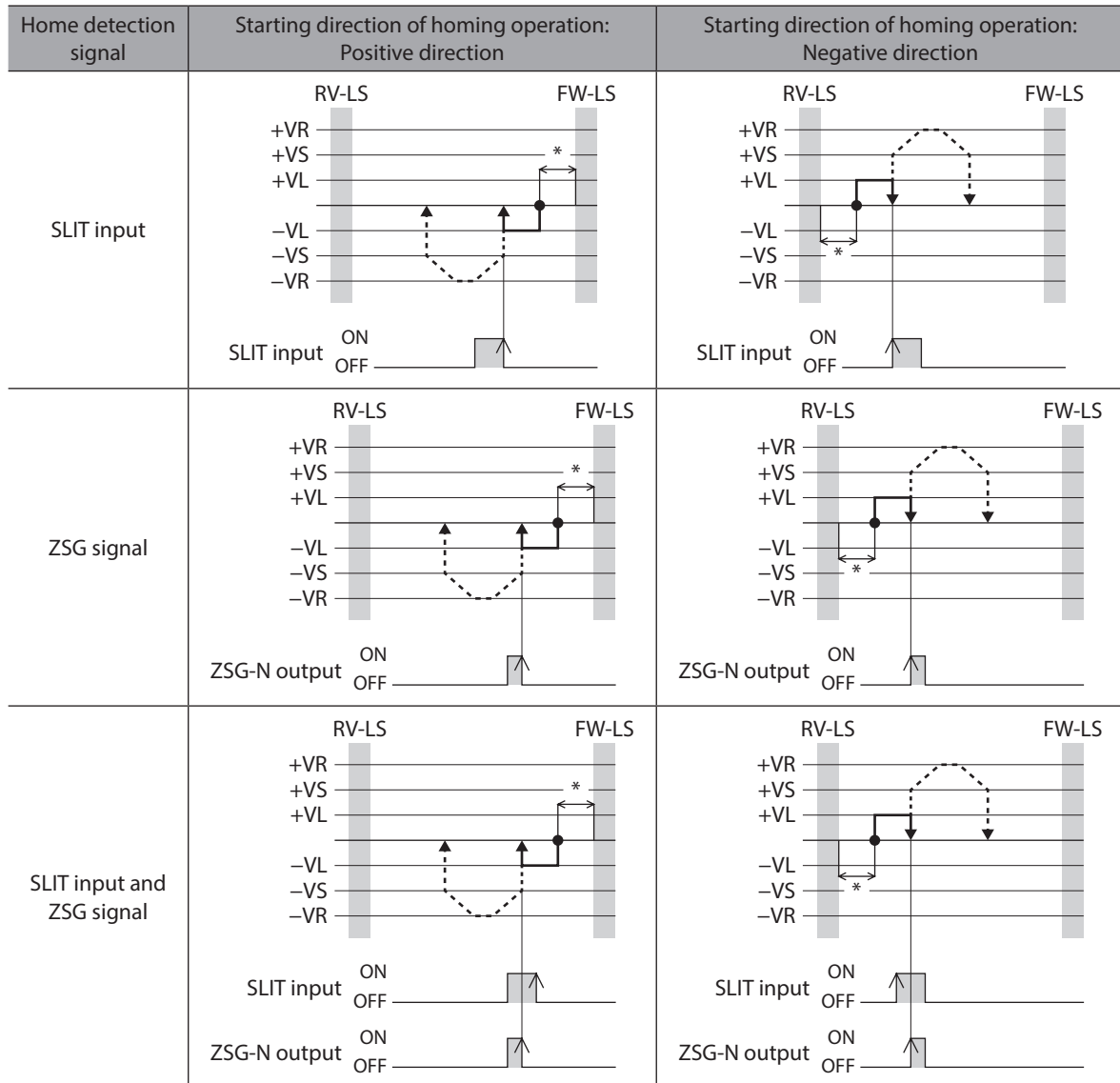

* The motor pulls out of the limit sensor, and rotates according to the value set in the "(HOME) Backward steps in 2 sensor homing."

7-3 One-way rotation mode

The motor operates in the "(HOME) Starting direction" at the "(HOME) Operating velocity," and it decelerates to a stop when the HOME sensor is detected. After that, the motor pulls out of the range of the HOME sensor at the "(HOME) Last velocity," operates according to the value set in the "(HOME) Operating amount in unidirectional homing" at the "(HOME) Starting velocity," and stops. The stop position is set as the home.

Explanation of code

- VR: (HOME) Operating velocity
- VS: (HOME) Starting velocity
- VL: (HOME) Last velocity
- ---: Orbit when (HOME) Travel amount of additional operation after homing is set

Starting position of homing operation	Starting direction of homing operation: Positive direction	Starting direction of homing operation: Negative direction
HOMES		
Other than HOMES		

* The motor pulls out of the HOME sensor, and rotates according to the value set in the "(HOME) Operating amount in unidirectional homing."

Note

- When operation is started from a position other than the HOME sensor, if the motor pulls out of the HOME sensor during deceleration stop after detection of the HOME sensor, an alarm of "Homing operation error" is generated. Set the "(HOME) Acceleration/deceleration" parameter so that the motor can stop in the range of the HOME sensor.
- When combined with a gear, set the "(HOME) Starting velocity" parameter and the "(HOME) Last velocity" parameter so that the motor shaft speed is 300 r/min or lower.

■ **When the SLIT input and/or ZSG signal are used concurrently**

Even after homing operation is completed, operation is continued until an external signal is detected. If an external signal is detected, homing operation is completed.

Home detection signal	Starting direction of homing operation: Positive direction	Starting direction of homing operation: Negative direction
SLIT input		
ZSG signal		
SLIT input and ZSG signal		

* The motor pulls out of the HOME sensor, and rotates according to the value set in the "(HOME) Operating amount in unidirectional homing."

7-4 Push-motion mode

The motor operates in the "(HOME) Starting direction" at the "(HOME) Operating velocity," and rotates in the reverse direction when a mechanism installed to the motor presses against a stopper or others mounted at the mechanical end. After that, the motor rotates according to the value set in the "(HOME) Backward steps after first entry in push-homing" and stops, and then operates again toward the stopper at the "(HOME) Last velocity." When the motor presses against a stopper or others again, it rotates in the reverse direction, rotates according to the value set in the "(HOME) Backward steps in push-homing" and stops.

Do not perform push-motion homing operation when combined with a gear.

Explanation of code

- VR: (HOME) Operating velocity
- VS: (HOME) Starting velocity
- VL: (HOME) Last velocity
- ---: Orbit when (HOME) Travel amount of additional operation after homing is set

Starting position of homing operation	Starting direction of homing operation: Positive direction		Starting direction of homing operation: Negative direction	
	Reverse side Mechanical end	Forward side Mechanical end	Reverse side Mechanical end	Forward side Mechanical end
Between mechanical ends				

*1 The motor rotates from the mechanical end according to the value set in the "(HOME) Backward steps after first entry in push-homing."

*2 The motor rotates from the mechanical end according to the value set in the "(HOME) Backward steps in push-homing."



When combined with a gear, do not perform push-motion homing operation.

■ **When the SLIT input and/or ZSG signal are used concurrently**

Even after homing operation is completed, operation is continued until an external signal is detected. If an external signal is detected, homing operation is completed.

Home detection signal	Starting direction of homing operation: Positive direction	Starting direction of homing operation: Negative direction
SLIT input	<p>Reverse side Mechanical end Forward side Mechanical end</p> <p>+VR +VS +VL -VL -VS -VR</p> <p>SLIT input ON OFF</p>	<p>Reverse side Mechanical end Forward side Mechanical end</p> <p>+VR +VS +VL -VL -VS -VR</p> <p>SLIT input ON OFF</p>
ZSG signal	<p>Reverse side Mechanical end Forward side Mechanical end</p> <p>+VR +VS +VL -VL -VS -VR</p> <p>ZSG-N output ON OFF</p>	<p>Reverse side Mechanical end Forward side Mechanical end</p> <p>+VR +VS +VL -VL -VS -VR</p> <p>ZSG-N output ON OFF</p>
SLIT input and ZSG signal	<p>Reverse side Mechanical end Forward side Mechanical end</p> <p>+VR +VS +VL -VL -VS -VR</p> <p>SLIT input ON OFF</p> <p>ZSG-N output ON OFF</p>	<p>Reverse side Mechanical end Forward side Mechanical end</p> <p>+VR +VS +VL -VL -VS -VR</p> <p>SLIT input ON OFF</p> <p>ZSG-N output ON OFF</p>

* The motor rotates from the mechanical end according to the value set in the "(HOME) Backward steps in push-homing."

8 Extended function

The operating method can be extended by changing parameters.

The relation between extendable operations and parameters is shown in the table below.

Operation type		Parameter name		
		Acceleration/ deceleration setting method	Accept stored data override operation start by START input	Automatic S-ON for the FW/RV operation
Drive profile		Available	Not available	Not available
Direct data operation		Available	Not available	Not available
Stored data operation		Available	Available	Not available
FW/RV operation	JOG operation	Not available	Not available	Available
	High-speed JOG operation	Not available	Not available	Available
	Inching operation	Not available	Not available	Available
	Continuous operation (position control)	Available	Not available	Available
	Continuous operation (speed control)	Available	Not available	Available
	Continuous operation (push-motion)	Available	Not available	Available
Homing operation	2-sensor mode	Not available	Not available	Not available
	3-sensor mode	Not available	Not available	Not available
	One-way rotation mode	Not available	Not available	Not available
	Push-motion mode	Not available	Not available	Not available

8-1 Acceleration/deceleration setting method

Changing the "Acceleration/deceleration setting method " parameter can change the motor operation when the velocity is changed.

■ When the user-defined acceleration/deceleration unit is "(User-defined velocity unit)/s"

● For acceleration/deceleration

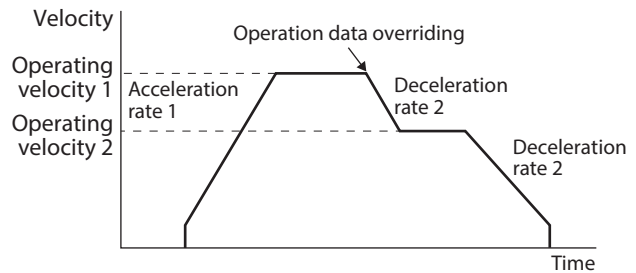
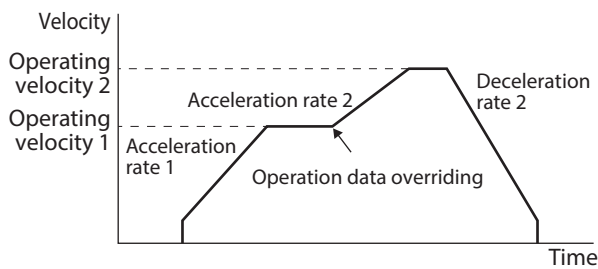

● For changing velocity/stop (AZ compatible)

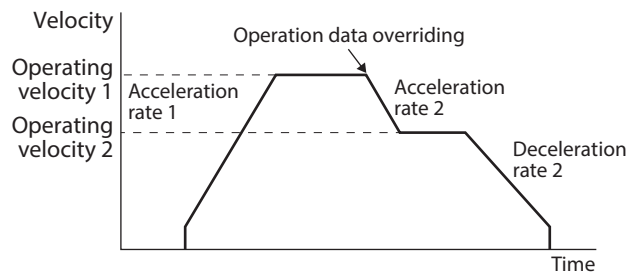
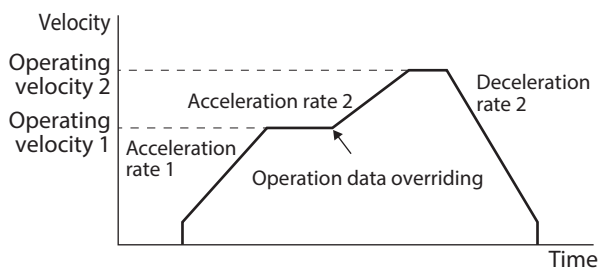

■ When the user-defined acceleration/deceleration unit is "ms"

● For acceleration/deceleration

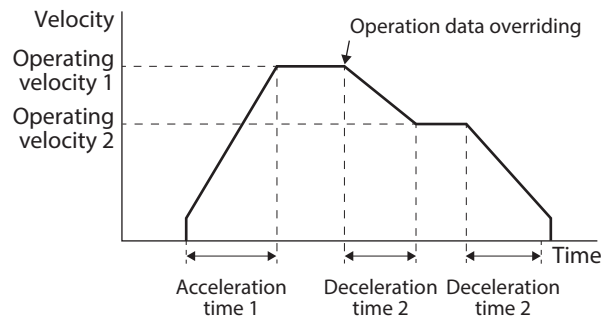
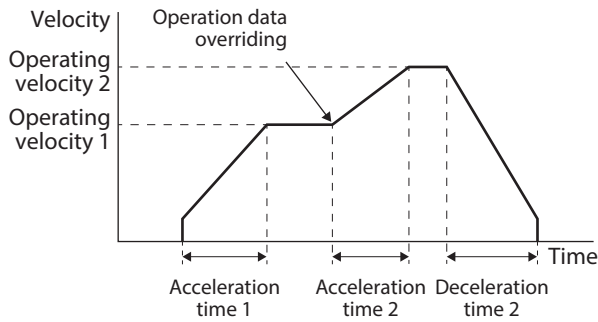

● For changing velocity/stop (AZ compatible)

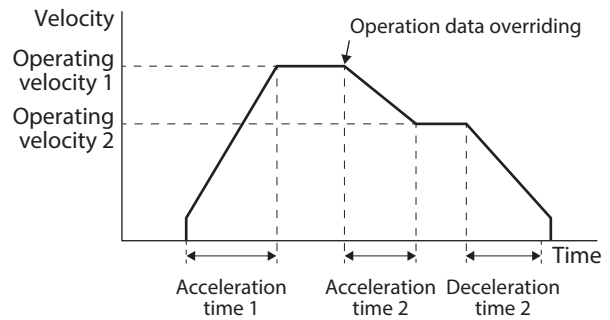
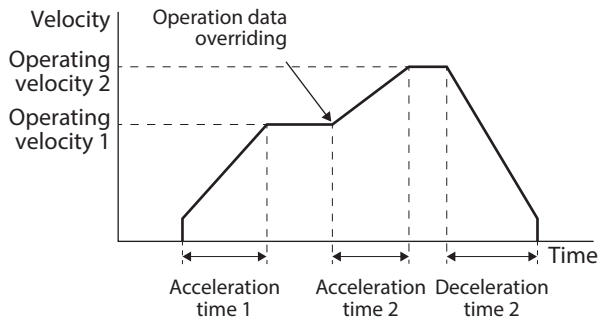

Related parameter

Parameter name	Description	Initial setting	
		Initial value	Unit
Acceleration/deceleration setting method	Selects the setting method for the acceleration rate and the deceleration rate. [Setting range] 0: Acceleration/deceleration 1: Changing velocity/stop (AZ compatible)	0	-

memo When the operation type is "Continuous operation (cyclic speed control)," the "Acceleration/deceleration setting method" parameter is not applied.

8-2 Accept stored data override operation start by START input

Setting the "Accept stored data override operation start by START input" parameter to "Enable" can override the operation data during stored data operation by the START input and the D-SEL input.

● Operating method

1. Check the RDY-SD-OPE output is being ON.
2. Select the operation data number using the M0 to M7 inputs, and turn the START input ON.
3. The RDY-SD-OPE output is turned OFF and the motor starts operation.
4. Check the RDY-SD-OPE output has been turned OFF and turn the START input OFF.
5. When the START input is turned OFF, the RDY-SD-OPE output is turned ON.
6. Select the operation data number using the M0 to M7 inputs, and turn the START input ON.
7. The operation data is overridden to execute operation.

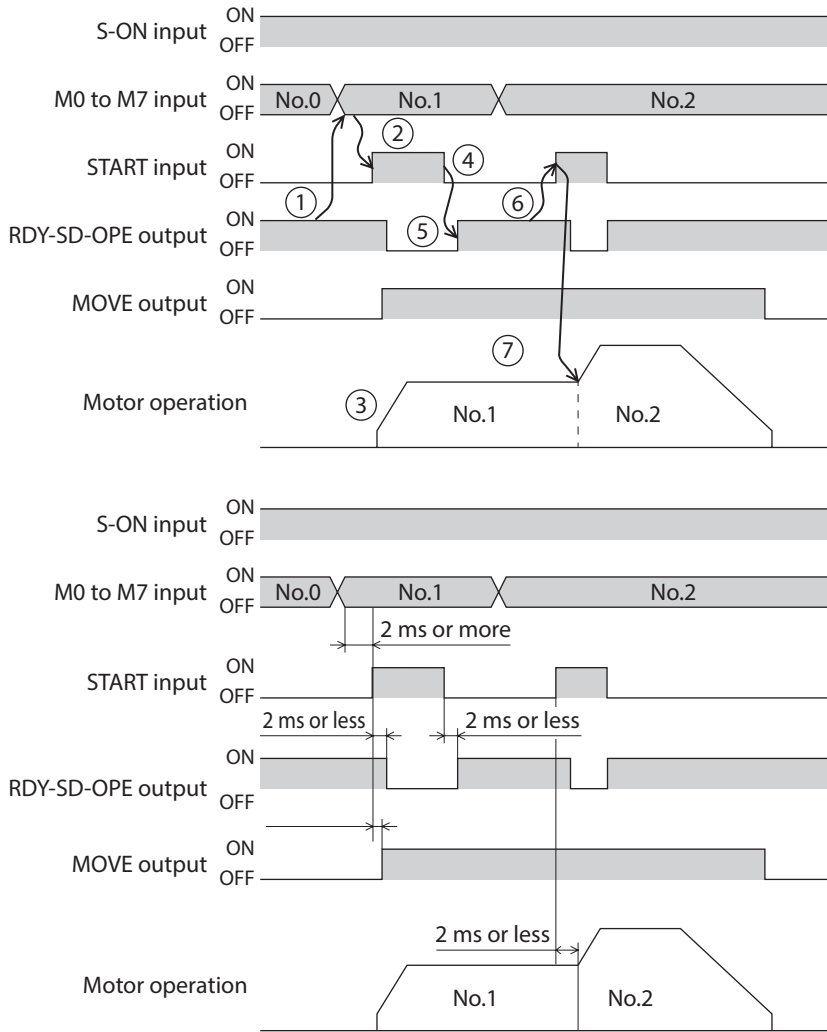

Note When the operation data is overridden, all information related to the sequence function is cleared.

memo The D-SEL input is enabled only when the "D-SEL drive start function" parameter is set to "1: Operation data number selection + START function."

Related parameter

Parameter name	Description	Initial setting	
		Initial value	Unit
Accept stored data override operation start by START input	Selects whether to start operation using the START input while operating. When the function of the D-SEL input is set to "Operation data number selection + START function," the D-SEL is also applied. [Setting range] 0: Disable 1: Enable	0	-

8-3 Automatic S-ON for the FW/RV operation

When the "Automatic S-ON for the FW/RV operation" parameter is set to "Enable," operation can be started from the excitation OFF state by automatically controlling the S-ON input in FW/RV operation.

● For FW-JOG-P/RV-JOG-P

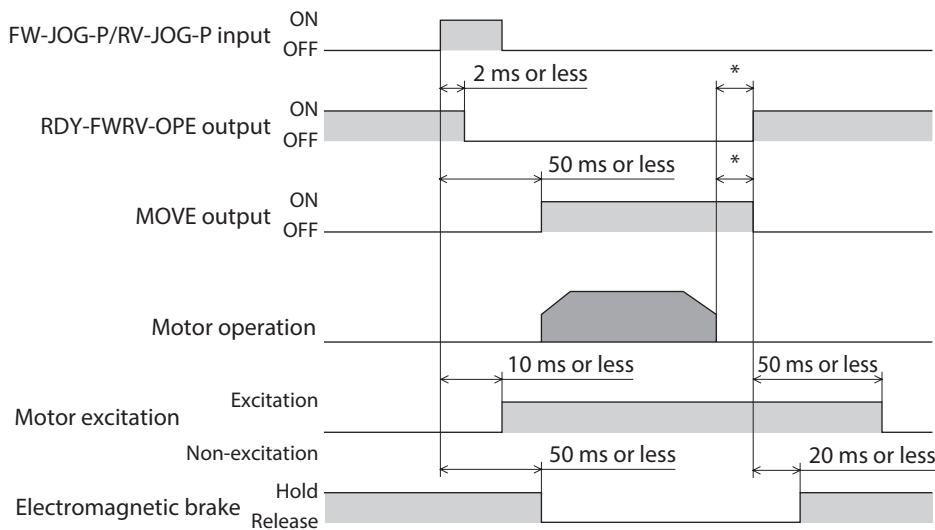

* It varies depending on the load, operating velocity, speed filter, etc.

● For other than FW-JOG-P/RV-JOG-P

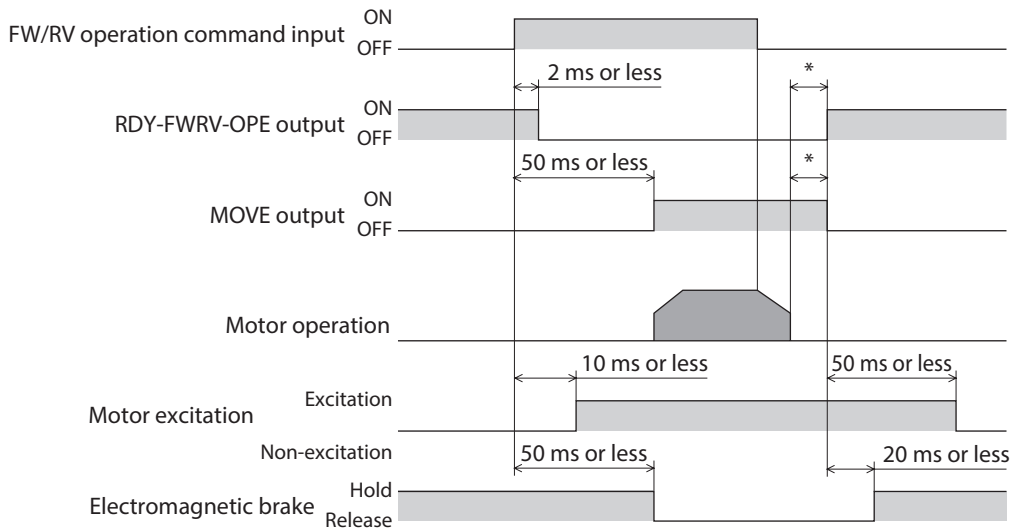

* It varies depending on the load, operating velocity, speed filter, etc.

Related parameter

Parameter name	Description	Initial setting	
		Initial value	Unit
Automatic S-ON for the FW/RV operation	Selects the setting that automatically turns the S-ON input ON in FW/RV operation. [Setting range] 0: Disable 1: Enable	0	-

3 I/O signals

This part describes input signals and output signals.

◆ Table of contents

1 Overview of I/O signals	148	5 Output signals	187
1-1 Overview of input signals	148	5-1 Driver status indication signals	187
1-2 Overview of output signals	148	5-2 Hardware status indication	188
1-3 Setting contents of input signals and output signals	149	5-3 Operation status indication	188
2 Signals list	151	5-4 Operation ready indication	193
2-1 Input signals list	151	5-5 Direct data operation status indication	194
2-2 Output signals list	154	5-6 Stored data operation status indication	195
3 Signal type	160	5-7 Function status indication	196
3-1 Direct I/O	160	5-8 Power removal function signals	196
3-2 Remote I/O	161	5-9 Motor position indication	197
4 Input signals	163	5-10 Coordinate status indication	199
4-1 Excitation switching signals	163	5-11 Latch information indication	200
4-2 Operation stop signals	166	5-12 User output signals	201
4-3 Signals used for stored data operation	177	5-13 Response output	203
4-4 Signals used for FW/RV operation	179	6 Using general signals	204
4-5 Signal used for homing operation	179	7 Timing chart	205
4-6 External sensor input signals	180		
4-7 Coordinate preset signals	181		
4-8 Status releasing signals	182		
4-9 Driver function change signals	183		
4-10 Communication setting change signals	185		
4-11 Latch input signals	186		
4-12 User alarm input signal	186		

1 Overview of I/O signals

1-1 Overview of input signals

■ Direct input

Direct input (DIN) is a method in which a signal is input directly by connecting the I/O cable to the connector. If the composite input function is used, a single input can turn two signals ON simultaneously, achieving saving of wiring.

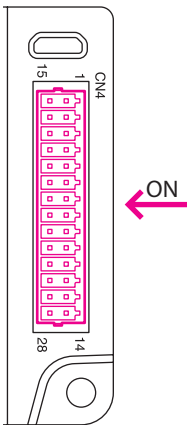

Name	Description
Input function	Select the input signal to be assigned to DIN.
Inverting mode	ON/OFF of the input signal can be changed.
ON signal dead-time	The input signal is turned ON when the time having set is exceeded. This can be used for taking measures to eliminate noise or for adjusting the timing between devices.
1-shot signal	The input signal having been turned ON is automatically turned OFF after 250 μ s.
Composite input function	When DIN is turned ON, the signal selected here is also turned ON.

1-2 Overview of output signals

■ Direct output

Direct output (DOUT) is a method in which a signal is output directly by connecting the I/O cable to the connector. If the composite output function is used, the logical combination result of two output signals can be output in a single signal.

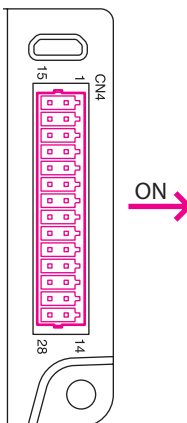

Name	Description
(Normal) Output function	Select the output signal to be assigned to DOUT.
Inverting mode	ON/OFF of the output signal can be changed.
OFF delay time	The output signal is turned OFF when the time having set is exceeded. This can be used for taking measures to eliminate noise or for adjusting the timing between devices.
Composite logical combination	Set the logical combination [logical conjunction or Logical disjunction] of the composite output function.
Composite output function	Select the output signal for logical operation with the signal of DOUT. When logical combination of the two signals has been established, DOUT is turned ON.
Composite inverting mode	Change ON/OFF of the signal selected in the composite output function.

1-3 Setting contents of input signals and output signals

■ Direct input

● Input function

Name	Description	Initial value
DIN0 input function	Selects the input signals to be assigned to DIN0 to DIN3. [Setting range] ⇒ "2-1 Input signals list" on p.151	72: ID-SELO
DIN1 input function		73: ID-SEL1
DIN2 input function		5: STOP
DIN3 input function		1: FREE

● Change of ON/OFF setting of input signals

Name	Description	Initial value
Inverting mode	Changes ON/OFF of DIN0 to DIN3. [Setting range] 0: Not invert 1: Invert	0

● ON signal dead-time

Name	Description	Initial value
ON signal dead-time	The input signal is turned ON when the time having set is exceeded. This can be used for taking measures to eliminate noise or for adjusting the timing between devices. [Setting range] 0 to 250 ms	0

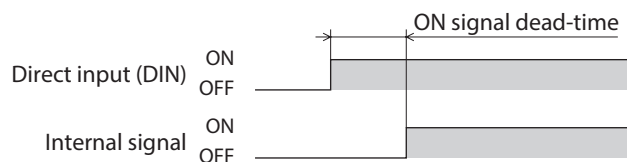

● 1-shot signal

Name	Description	Initial value
1-shot signal	Automatically turns the signal, which was input to DIN0 to DIN3, to OFF (or ON) 250 μ s after input. [Setting range] 0: Disable 1: Enable	0

Note When the HMI input is assigned to the DIN input function, do not set the "1-shot signal" parameter to "Enable."

● Composite input function

Name	Description	Initial value
Composite input function	Automatically turns the signal, which was input to DIN0 to DIN3, to OFF (or ON) 250 μ s after input. [Setting range] ⇒ "2-1 Input signals list" on p.151	0: Not used

■ Direct output

● (Normal) Output function

Name	Description	Initial value
DOUT0 (normal) Output function	Selects the output signals to be assigned to DOUT0 and DOUT1. [Setting range] ⇒ "2-2 Output signals list" on p.154	241: COMM-PWR
DOUT1 (normal) Output function		130: ALM-B

● Inverting mode

Name	Description	Initial value
Inverting mode	Changes ON/OFF of DOUT0 and DOUT1. [Setting range] 0: Not invert 1: Invert	0

● OFF delay time

Name	Description	Initial value
OFF delay time	Sets the OFF delay time of DOUT0 and DOUT1. This can be used for taking measures to eliminate noise or for adjusting the timing between devices. [Setting range] 0 to 4,000 ms	0

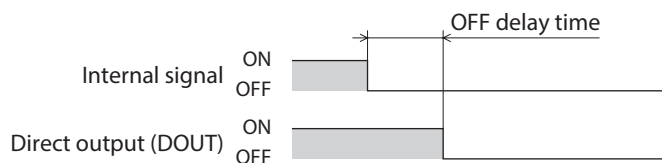

● Composite logical combination

Name	Description	Initial value
Composite logical combination	Sets the logical combination [logical conjunction or logical disjunction] of the composite output function. [Setting range] 0: AND 1: OR	1

● Composite output function

Name	Description	Initial value
Composite output function	Selects the output signals for logical operation with the signals of DOUT0 and DOUT1. When logical combination of the two signals has been established, the output is turned ON. [Setting range] ⇒ "2-2 Output signals list" on p.154	128: CONST-OFF

● Composite inverting mode

Name	Description	Initial value
Composite inverting mode	Changes ON/OFF of the composite output function. [Setting range] 0: Not invert 1: Invert	0

2 Signals list

Assign I/O signals using the support software or via industrial network.

2-1 Input signals list

To assign signals via industrial network, use the "assignment numbers" in the table instead of the signal names. Refer to "4 Input signals" on p.163 for details about each signal.

Assignment number	Signal name	Function
0	Not used	Set when the input terminal is not used.
1	FREE	Shut off the motor current to put the motor into a non-excitation state. When an electromagnetic brake motor is used, the electromagnetic brake is released.
2	S-ON	Put the motor into an excitation state.
3	CLR	Clear the deviation (position deviation) between the demand position and actual position.
4	QSTOP	Stop the motor.
5	STOP	Stop the motor.
7	BREAK-ATSQ	Switch from automatic sequential to manual sequential. Continuous sequential operation is not changed.
8	ALM-RST	Reset the alarm generated presently.
9	P-PRESET	Rewrite the mechanical home to the present position.
10	EL-PRST	Switch to the coordinate system with the electrical home as the home.
11	USR-ALM *	Generate the user alarm.
12	ETO-CLR	Release the ETO status generated presently.
13	LAT-CLR	Clear the latch information.
14	INFO-CLR	Clear the information status.
16	HMI	Release the function limitation of the support software.
18	TRQ-LMT	Enable the TRQ-LMT input torque limiting.
19	SPD-LMT	Enable the SPD-LMT input speed limit.
24	PLOOP-MODE	Enable the position loop.
25	ATL-EN	Enable the ATL function.
32	START	Execute stored data operation.
33	SSTART	Execute stored data operation. In manual sequential operation, operation of the next data number is executed.
35	NEXT	Transition to the linked operation data number forcibly.
36	HOME	Execute homing operation.
40	M0	Select the operation data number using eight bits.
41	M1	
42	M2	
43	M3	
44	M4	
45	M5	
46	M6	
47	M7	
48	FW-JOG	Execute JOG operation in the forward direction.
49	RV-JOG	Execute JOG operation in the reverse direction.
50	FW-JOG-H	Execute high-speed JOG operation in the forward direction.

Assignment number	Signal name	Function
51	RV-JOG-H	Execute high-speed JOG operation in the reverse direction.
52	FW-JOG-P	Execute inching operation in the forward direction.
53	RV-JOG-P	Execute inching operation in the reverse direction.
56	FW-POS	Execute continuous operation (position control) in the forward direction.
57	RV-POS	Execute continuous operation (position control) in the reverse direction.
58	FW-SPD	Execute continuous operation (speed control) in the forward direction.
59	RV-SPD	Execute continuous operation (speed control) in the reverse direction.
60	FW-PSH	Execute continuous operation (push-motion) in the forward direction.
61	RV-PSH	Execute continuous operation (push-motion) in the reverse direction.
64	USR-LAT-IN0	These are external latch signals.
65	USR-LAT-IN1	
66	FW-BLK	Stop the operation in the forward direction.
67	RV-BLK	Stop the operation in the reverse direction.
68	FW-LS	This is a signal to be input from the limit sensor in the forward direction.
69	RV-LS	This is a signal to be input from the limit sensor in the reverse direction.
70	HOMES	This is a signal input from the mechanical home sensor.
71	SLIT	This is a signal to be input from the slit sensor.
72	ID-SEL0	Set the address number for RS-485 communication and CAN communication.
73	ID-SEL1	
74	ID-SEL2	
75	ID-SEL3	Execute operation based on the operation data number having set in the D-SEL input.
80	D-SEL0	
81	D-SEL1	
82	D-SEL2	
83	D-SEL3	
84	D-SEL4	
85	D-SEL5	
86	D-SEL6	
87	D-SEL7	
88	D-SEL8	
89	D-SEL9	
90	D-SEL10	
91	D-SEL11	
92	D-SEL12	
93	D-SEL13	
94	D-SEL14	
95	D-SEL15	These are general signals.
96	R0	
97	R1	
98	R2	
99	R3	
100	R4	
101	R5	
102	R6	
103	R7	
104	R8	
105	R9	
106	R10	

Assignment number	Signal name	Function
107	R11	These are general signals.
108	R12	
109	R13	
110	R14	
111	R15	
112	R16	
113	R17	
114	R18	
115	R19	
116	R20	
117	R21	
118	R22	
119	R23	
120	R24	
121	R25	
122	R26	
123	R27	
124	R28	
125	R29	
126	R30	
127	R31	

* It is effective for the driver version 3.00 or later.

2-2 Output signals list

To assign signals via industrial network, use the "assignment numbers" in the table instead of the signal names. Refer to "5 Output signals" on p.187 for details about each signal.

Assignment number	Signal name	Function
0	Not used	Set when the output terminal is not used.
1	FREE_R	Output in response to the input signal.
2	S-ON_R	
3	CLR_R	
4	QSTOP_R	
5	STOP_R	
7	BREAK-ATSQ_R	
8	ALM-RST_R	
9	P-PRESET_R	
10	EL-PRST_R	
11	USR-ALM_R	
12	ETO-CLR_R	
13	LAT-CLR_R	
14	INFO-CLR_R	
16	HMI_R	
18	TRQ-LMT_R	
19	SPD-LMT_R	
24	PLOOP-MODE_R	
25	ATL-EN_R	
32	START_R	
33	SSTART_R	
35	NEXT_R	
36	HOME_R	
40	M0_R	
41	M1_R	
42	M2_R	
43	M3_R	
44	M4_R	
45	M5_R	
46	M6_R	
47	M7_R	
48	FW-JOG_R	
49	RV-JOG_R	
50	FW-JOG-H_R	
51	RV-JOG-H_R	
52	FW-JOG-P_R	
53	RV-JOG-P_R	
56	FW-POS_R	
57	RV-POS_R	
58	FW-SPD_R	
59	RV-SPD_R	
60	FW-PSH_R	
61	RV-PSH_R	
64	USR-LAT-INO_R	

Assignment number	Signal name	Function
65	USR-LAT-IN1_R	Output in response to the input signal.
66	FW-BLK_R	
67	RV-BLK_R	
68	FW-LS_R	
69	RV-LS_R	
70	HOMES_R	
71	SLIT_R	
72	ID-SEL0_R	
73	ID-SEL1_R	
74	ID-SEL2_R	
75	ID-SEL3_R	
80	D-SEL0_R	
81	D-SEL1_R	
82	D-SEL2_R	
83	D-SEL3_R	
84	D-SEL4_R	
85	D-SEL5_R	
86	D-SEL6_R	
87	D-SEL7_R	
88	D-SEL8_R	
89	D-SEL9_R	
90	D-SEL10_R	
91	D-SEL11_R	
92	D-SEL12_R	
93	D-SEL13_R	
94	D-SEL14_R	
95	D-SEL15_R	
96	R0_R	
97	R1_R	
98	R2_R	
99	R3_R	
100	R4_R	
101	R5_R	
102	R6_R	
103	R7_R	
104	R8_R	
105	R9_R	
106	R10_R	
107	R11_R	
108	R12_R	
109	R13_R	
110	R14_R	
111	R15_R	
112	R16_R	
113	R17_R	
114	R18_R	
115	R19_R	
116	R20_R	

Assignment number	Signal name	Function
117	R21_R	Output in response to the input signal.
118	R22_R	
119	R23_R	
120	R24_R	
121	R25_R	
122	R26_R	
123	R27_R	
124	R28_R	
125	R29_R	
126	R30_R	
127	R31_R	
128	CONST-OFF	Output an OFF state all the time.
129	ALM-A	Output the alarm status of the driver (normally open).
130	ALM-B	Output the alarm status of the driver (normally closed).
131	SYS-RDY	Output when the main power supply of the driver is turned on.
133	SON-MON	Output when the motor is in an excitation state.
134	MOVE	Output when the motor operates.
135	INFO	Output the information status of the driver.
136	SYS-BSY	Output when the driver is in an internal processing state.
137	ETO-MON	Output when the driver is in the ETO status.
138	IN-POS	Output when positioning operation is completed.
140	TLC	Output when the output torque reaches the maximum output torque or the torque limiting value.
141	VA	Output when the operating velocity reaches the target velocity.
142	ZV	Output when the actual velocity reaches the velocity 0.
145	RDY-HOME-OPE	Output when the driver is ready to start homing operation.
146	RDY-FWRV-OPE	Output when the driver is ready to start FW/RV operation.
147	RDY-SD-OPE	Output when the driver is ready to start stored data operation.
148	RDY-DD-OPE	Output when the driver is ready to start direct data operation.
149	RDY-DPROF-OPE	Output when the driver is ready to operate the drive profile.
152	OPE-BSY	Output while internal oscillation is being performed.
154	SEQ-BSY	Output when stored data operation is being performed.
155	DELAY-BSY	Output when the driver is set in a standby state (Drive-complete delay time, Dwell).
159	DDBUF-FULL	Output when data is being written to the buffer area of direct data operation or drive profile.
160	AREA0	Output when the motor is within the area.
161	AREA1	
162	AREA2	
163	AREA3	
164	AREA4	
165	AREA5	
166	AREA6	
167	AREA7	
168	WRAP-OVF	The output is inverted when the WRAP range is exceeded. (Toggle action)
169	FW-SLS	Output when the software limit in the forward direction is reached.
170	RV-SLS	Output when the software limit in the reverse direction is reached.
171	ZSG-N	Output every time the motor shaft rotates by 72° from the home.

Assignment number	Signal name	Function
172	WRAP-ZERO	Output if the motor is in the home of the WRAP range when the "WRAP setting" parameters is set to "Follows WRAP setting lower limit/WRAP setting upper limit."
175	MAREA	Output when the motor is within the area that was set to the operation data.
176	HOME-END	Output when homing operation is completed or position preset is executed.
177	ABSPEN	Output when coordinates are set.
178	ELPRST-MON	Output when the electrical home coordinate is enabled.
184	USR-LAT0	Output when the external latch signal is detected.
185	USR-LAT1	
186	JUMP0-LAT	Output when the (Low) I/O event number trigger is detected.
187	JUMP1-LAT	Output when the (Middle) I/O event number trigger is detected.
188	JUMP2-LAT	Output when the (High) I/O event number trigger is detected.
189	NEXT-LAT	Output when the operation is transitioned by the NEXT input.
190	STOP-LAT	Output when the operation is stopped by the STOP input or the QSTOP input.
192	PLOOP-MON	Output when the position loop is enabled.
193	SLIP	Output when a slip occurred in the motor.
194	ATL-MON	Output when the ATL function is enabled.
199	M-CHG	The output is inverted when operation is started, the operation data number is switched, or the operation data is overwritten. (Toggle operation) *
200	M-ACT0	Output the status of the M0 input corresponding to the operation data number during operation.
201	M-ACT1	Output the status of the M1 input corresponding to the operation data number during operation.
202	M-ACT2	Output the status of the M2 input corresponding to the operation data number during operation.
203	M-ACT3	Output the status of the M3 input corresponding to the operation data number during operation.
204	M-ACT4	Output the status of the M4 input corresponding to the operation data number during operation.
205	M-ACT5	Output the status of the M5 input corresponding to the operation data number during operation.
206	M-ACT6	Output the status of the M6 input corresponding to the operation data number during operation.
207	M-ACT7	Output the status of the M7 input corresponding to the operation data number during operation.
208	D-END0	Output when the operation of the specified operation data number is completed.
209	D-END1	
210	D-END2	
211	D-END3	
212	D-END4	
213	D-END5	
214	D-END6	
215	D-END7	
216	D-END8	
217	D-END9	
218	D-END10	
219	D-END11	
220	D-END12	

Assignment number	Signal name	Function
221	D-END13	Output when the operation of the specified operation data number is completed.
222	D-END14	
223	D-END15	
224	TRQ-LMTD	Output when the torque limiting by the TRQ-LMT input is enabled.
225	SPD-LMTD	Output when the speed limit by the SPD-LMT input is enabled.
228	OL-DTCT	Output when the output torque reaches the torque to detect the overload alarm.
232	USR-OUT0	Output a logical conjunction or a logical disjunction of two types of output signals and the comparison result with the internal monitor group.
233	USR-OUT1	
234	USR-OUT2	
235	USR-OUT3	
236	USR-OUT4	
237	USR-OUT5	
238	USR-OUT6	
239	USR-OUT7	
240	MAIN-PWR	Output when the main power supply is in an ON state.
241	COMM-PWR	Output when the power supply for communication is in an ON state.
244	MBC	Output when the electromagnetic brake is in a state of being released.
252	EDM-MON	Output when both the HWTO1 and HWTO2 inputs are turned OFF.
253	HWTOIN-MON	Output when either the HWTO1 input or the HWTO2 input is turned OFF.
256	INFO-USRIO-G	Output when the corresponding information is generated. Refer to p.451 for the information list.
257	INFO-START-G	
258	INFO-485-G	
262	INFO-MNT-G	
263	INFO-SET-G	
264	INFO-DRVTMP	
265	INFO-MTRTMP	
266	INFO-LOAD	
267	INFO-TRQ	
268	INFO-WATT	
272	INFO-VOLT-H	
273	INFO-VOLT-L	
283	INFO-PRESET	
284	INFO-DSLMTD	
285	INFO-IOTEST	
286	INFO-CONFIG	
287	INFO-REBOOT	
288	INFO-USRIO0	
289	INFO-USRIO1	
290	INFO-USRIO2	
291	INFO-USRIO3	
292	INFO-USRIO4	
293	INFO-USRIO5	
294	INFO-USRIO6	
295	INFO-USRIO7	
296	INFO-POS-ERR	
300	INFO-SPD-H	

Assignment number	Signal name	Function
301	INFO-SPD-L	Output when the corresponding information is generated. Refer to p.451 for the information list.
302	INFO-SPD-ERR	
304	INFO-TLC-TIME	
306	INFO-CULD0	
307	INFO-CULD1	
311	INFO-STLTIME	
320	INFO-WH-BOOT	
321	INFO-WH-USR	
322	INFO-WH-TOTAL	
326	INFO-MP-FWCRNT	
327	INFO-MP-RVCRNT	
328	INFO-TRIP0	
329	INFO-TRIP1	
330	INFO-ODO	
332	INFO-CPU-LOAD	
333	INFO-PTIME	
334	INFO-PCOUNT	
336	INFO-485-ERR	
337	INFO-485-PRCST	
338	INFO-485-INTVL	
344	INFO-CAN-WNG	
353	INFO-START-HOME	
354	INFO-START-FWRV	
355	INFO-START-SD	
356	INFO-START-DD	
357	INFO-START-DP	
359	INFO-IODRV-DIS	
360	INFO-FW-OT	
361	INFO-RV-OT	
368	INFO-UNIT-E	
369	INFO-SOFTLMT-E	
376	INFO-CPU-FAULT	
377	INFO-OC-FAULT	
378	INFO-ENC-FAULT	

* In the case of operations other than stored data operation and continuous operation of FW/RV operation, it is effective for the driver version 3.00 or later.

3 Signal type

3-1 Direct I/O

Direct I/O is I/O to be accessed via the I/O signal connector.

■ Assignment to input terminals

Assign the input signals to the input terminals DIN0 to DIN3 using the "DIN0 input function" to "DIN3 input function" parameters.

Refer to "2-1 Input signals list" on p.151 for input signals that can be assigned.

Connector terminal number	Terminal name	Initial value
16	DIN0	ID-SEL0
17	DIN1	ID-SEL1
18	DIN2	STOP
19	DIN3	FREE

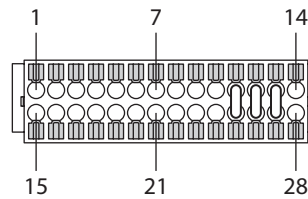

Note

- When the same input signal is assigned to multiple input terminals, the function will be executed if any of the terminals becomes active.
- When the HMI input is not assigned to the input terminal, this input will always be set to ON. Also, when this input is assigned to both direct I/O and remote I/O, the function will be executed only when both of them are turned ON.

■ Assignment to output terminals

Assign the output signals to the output terminals DOUT0 and DOUT1 using the "DOUT0 (normal) Output function" and "DOUT1 (normal) Output function" parameters.

Refer to "2-2 Output signals list" on p.154 for the output signals that can be assigned.

Connector terminal number	Terminal name	Initial value
1, 2	DOUT0	COMM-PWR
3, 4	DOUT1	ALM-B

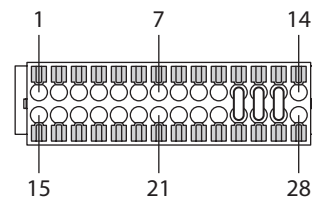

3-2 Remote I/O

Remote I/O is I/O to be accessed via RS-485 communication.

■ Assignment to input signals

Assign the input signals to R-IN0 to R-IN31 of remote I/O using the "R-IN0 input function" to "R-IN31 input function" parameters.

Refer to "2-1 Input signals list" on p.151 for input signals that can be assigned.

Remote I/O signal name	Initial value	Remote I/O signal name	Initial value
R-IN0	S-ON	R-IN16	FW-JOG-P
R-IN1	PLOOP-MODE	R-IN17	RV-JOG-P
R-IN2	TRQ-LMT	R-IN18	FW-SPD
R-IN3	CLR	R-IN19	RV-SPD
R-IN4	QSTOP	R-IN20	HOME
R-IN5	STOP	R-IN21	Not used
R-IN6	FREE	R-IN22	START
R-IN7	ALM-RST	R-IN23	SSTART
R-IN8	D-SEL0	R-IN24	M0
R-IN9	D-SEL1	R-IN25	M1
R-IN10	D-SEL2	R-IN26	M2
R-IN11	D-SEL3	R-IN27	M3
R-IN12	D-SEL4	R-IN28	M4
R-IN13	D-SEL5	R-IN29	M5
R-IN14	D-SEL6	R-IN30	M6
R-IN15	D-SEL7	R-IN31	M7

Note

- When the same input signal is assigned to multiple input terminals, the function will be executed if any of the terminals becomes active.
- When the HMI input is not assigned to the input terminal, this input will always be set to ON. Also, when this input is assigned to both direct I/O and remote I/O, the function will be executed only when both of them are turned ON.

■ Assignment to output signals

Assign the output signals to R-OUT0 to R-OUT31 of remote I/O using the "R-OUT0 output function" to "R-OUT31 output function" parameters.

Refer to "2-2 Output signals list" on p.154 for the output signals that can be assigned.

Remote I/O signal name	Initial value	Remote I/O signal name	Initial value
R-OUT0	SON-MON	R-OUT16	INFO
R-OUT1	PLOOP-MON	R-OUT17	INFO-MNT-G
R-OUT2	TRQ-LMTD	R-OUT18	INFO-DRVTMP
R-OUT3	RDY-DD-OPE	R-OUT19	INFO-MTRTMP
R-OUT4	ABSPEN	R-OUT20	INFO-TRQ
R-OUT5	STOP_R	R-OUT21	INFO-WATT
R-OUT6	FREE_R	R-OUT22	INFO-VOLT-H
R-OUT7	ALM-A	R-OUT23	INFO-VOLT-L
R-OUT8	SYS-BSY	R-OUT24	INFO-START-G
R-OUT9	IN-POS	R-OUT25	INFO-USRIO-G
R-OUT10	RDY-HOME-OPE	R-OUT26	CONST-OFF
R-OUT11	RDY-FWRV-OPE	R-OUT27	CONST-OFF
R-OUT12	RDY-SD-OPE	R-OUT28	CONST-OFF
R-OUT13	MOVE	R-OUT29	CONST-OFF
R-OUT14	VA	R-OUT30	USR-OUT0
R-OUT15	TLC	R-OUT31	USR-OUT1

4 Input signals

4-1 Excitation switching signals

These are signals to switch the motor excitation state between excitation and non-excitation.

■ S-ON input

Turning the S-ON input ON causes the motor to put into an excitation state. Turning it OFF causes the motor to put into a non-excitation state.

In the case of an electromagnetic brake motor, the electromagnetic brake is released after the motor puts into an excitation state.

1. When the S-ON input is turned ON, the motor puts into an excitation state and the operation ready output is turned ON.
The electromagnetic brake is released.
2. When the S-ON input is turned OFF, the operation ready output is turned OFF and the motor puts into a non-excitation state.
The electromagnetic brake actuates to hold the motor shaft.

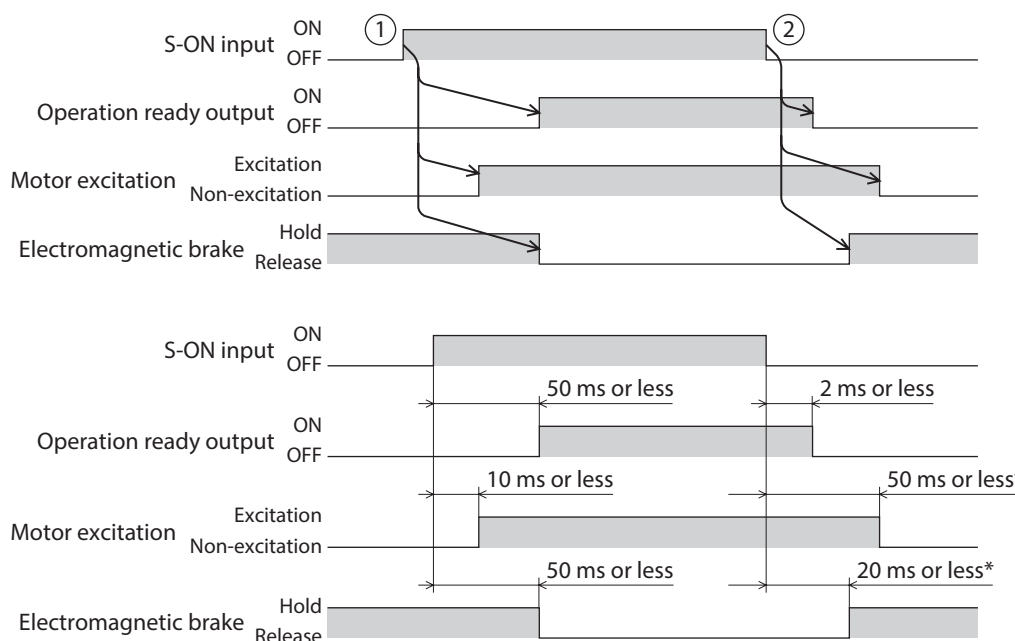

* The time period varies depending on a load or an operating condition while the motor rotates.



If the motor excitation is turned off to put into a non-excitation state while the motor is rotating, the motor, the driver, or the equipment may be damaged.

■ FREE input

Turning the FREE input ON causes the motor current to shut off and the motor to put into a non-excitation state. The motor output shaft can be rotated manually since the motor holding force is lost. When an electromagnetic brake motor is used, the electromagnetic brake is also released.



Note When a load is installed vertically, do not turn the FREE input ON. The motor loses its holding force, and the load may fall.

● When the motor is in an excitation state

1. When the FREE input is turned ON, the operation ready output is turned OFF and the motor puts into a non-excitation state.
2. When the FREE input is turned OFF, the motor puts into an excitation state and the operation ready output is turned ON.

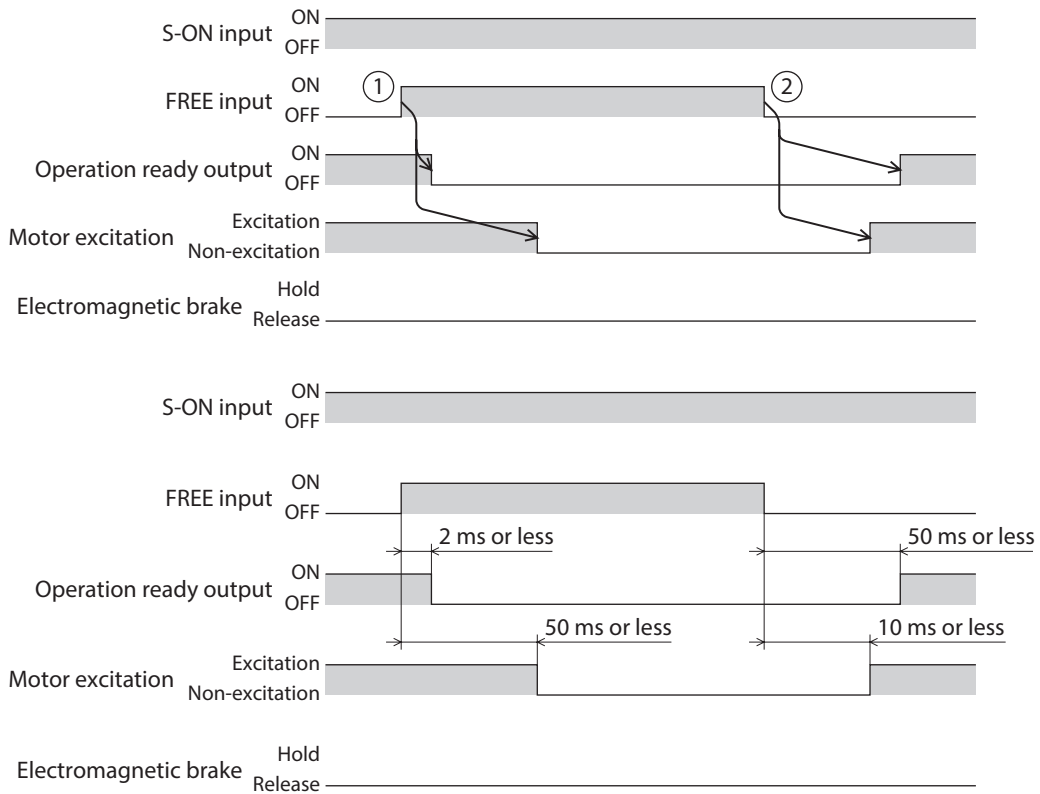

● **When the motor is in a non-excitation state**

1. When the FREE input is turned ON, the electromagnetic brake is released.
2. When the FREE input is turned OFF, the electromagnetic brake actuates to hold the motor shaft.

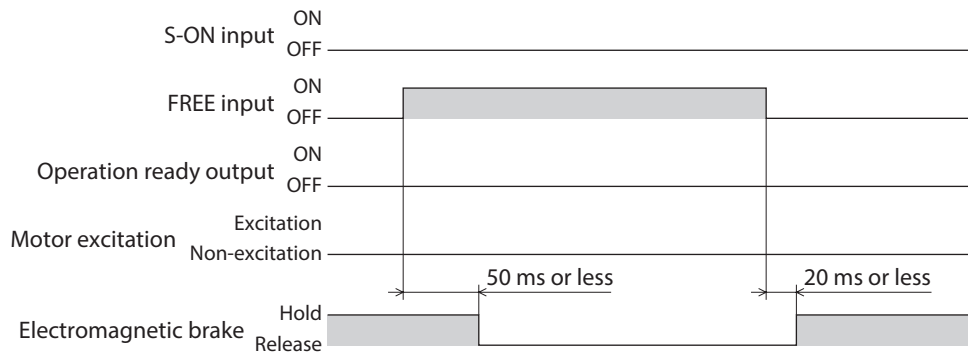
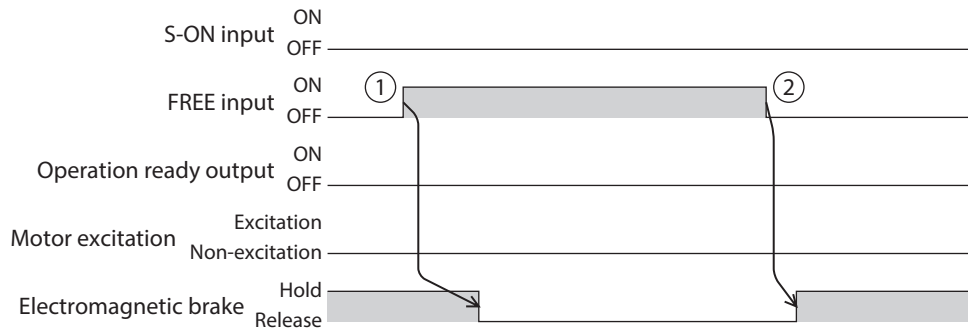

4-2 Operation stop signals

These are signals to stop the motor operation.

The IN-POS output is not turned ON even if an input of the operation stop signal is turned ON.

■ CLR input

Turning the CLR input ON causes the position deviation counter to clear, and the position deviation between the demand position and the actual position is set to zero. The motor stops immediately if it is operating.

1. When the CLR input is turned ON during operation, the motor stops and the position deviation is also cleared.
2. When the CLR input is turned OFF, the operation ready output is turned ON.

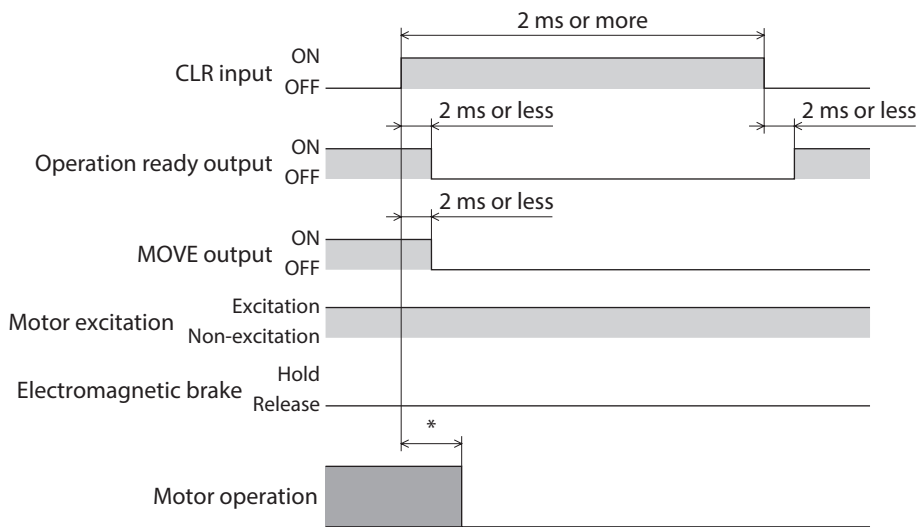
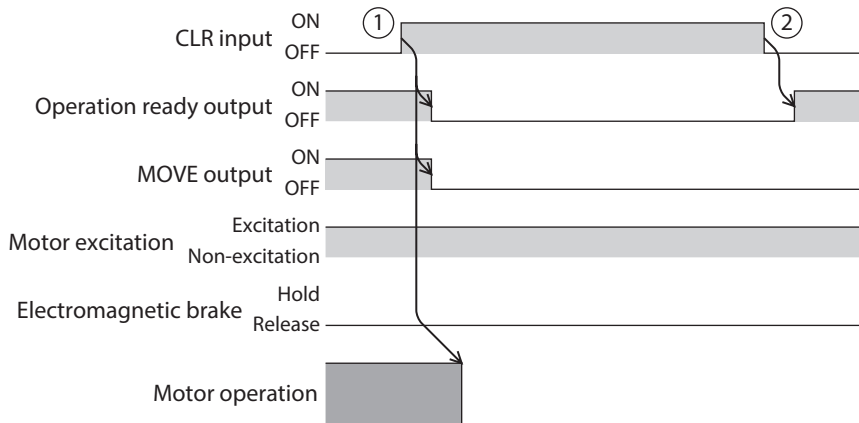

* It varies depending on the driving condition.



Note When combined with a gear, do not stop by the CLR input in a state where the motor shaft speed exceeds 300 r/min.

■ STOP input

Turning the STOP input ON causes the motor to stop.

The operation is stopped according to the "STOP input action" parameter.

The torque limiting value when stopped is based on the "STOP input stopping Torque limit value" parameter.

The remaining travel amount is cleared if positioning operation is being executed.

Related parameters

Parameter name	Description	Initial setting	
		Initial value	Unit
STOP input action	Sets how to stop the motor when the STOP input is turned ON. [Setting range] -3: Deceleration time stop (according to the Custom stopping time parameter) -2: Deceleration rate stop (according to the Custom stopping rate parameter) -1: Immediate stop 1: Deceleration stop (according to the operation profile during operation except for the torque limiting value) 2: Deceleration rate stop (according to the Quick stop rate parameter)	1	–
STOP input stopping Torque limiting value	Sets the torque limiting value when the STOP input is turned ON. [Setting range] 0: Use profile torque limit continuously 1 to 10,000 (1=0.1%)	0	1=0.1%
Quick stop rate	Sets the deceleration rate when "Deceleration rate stop (according to the Quick stop rate parameter)" is selected in the "STOP input action" and "QSTOP input action" parameters. [Setting range] 1 to 1,000,000,000 (User-defined velocity unit/s)	1,000	(r/min)/s
Custom stopping rate	Sets the deceleration rate when "Deceleration rate stop (according to the Custom stopping rate parameter)" is selected in the "STOP input action" and "QSTOP input action" parameters. [Setting range] 1 to 1,000,000,000 (User-defined velocity unit/s)	1,000	(r/min)/s
Custom stopping time	Sets the deceleration time when "Deceleration time stop (according to the Custom stopping time parameter)" is selected in the "STOP input action" and "QSTOP input action" parameters. [Setting range] 1 to 1,000,000,000 ms	1,000	ms
Timeout of waiting for motor rotation stop at standstill *	Sets the timeout period from when the velocity demand becomes zero at standstill until the motor actually stops rotating. When the timeout occurs, the MOVE output is turned OFF. [Setting range] -1: No timeout setting 0 to 32,767 ms	1,000	ms

* It is effective for the driver version 3.00 or later.

● When the stopping movement by the STOP input is other than "Immediate stop" (when the motor stops while the STOP input is ON)

1. When the STOP input is turned ON during operation, the operation ready output is turned OFF and the motor starts the stopping movement.
2. When the STOP input is turned OFF, the operation ready output is turned ON.

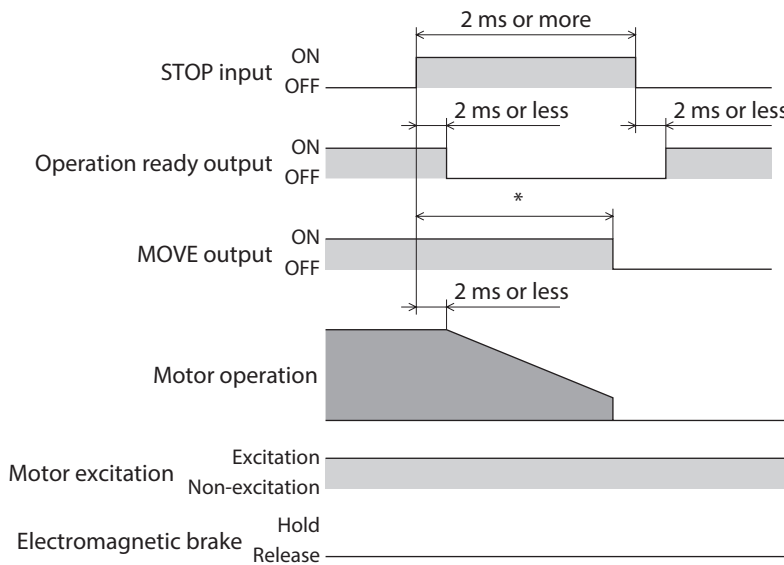
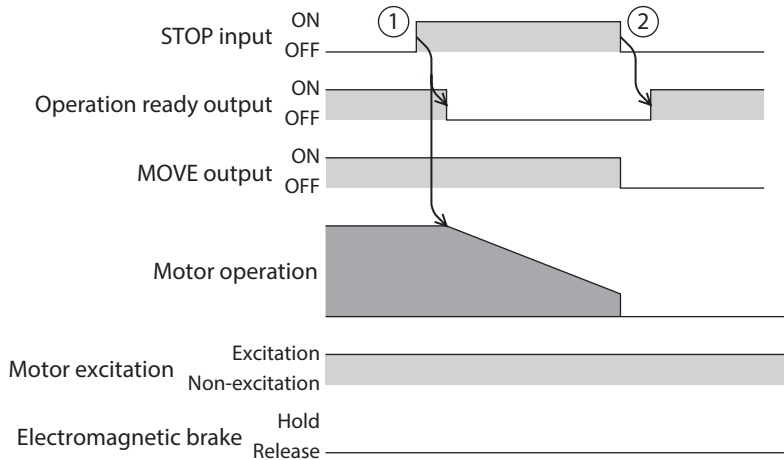

* It varies depending on the driving condition.

● **When the stopping movement by the STOP input is other than "Immediate stop" (when the motor does not stop while the STOP input is ON)**

1. When the STOP input is turned ON during operation, the operation ready output is turned OFF and the motor starts the stopping movement.
Even after the STOP input was turned OFF, the motor continues the deceleration operation until it stops.
2. When the STOP input is turned OFF, the operation ready output is turned ON.

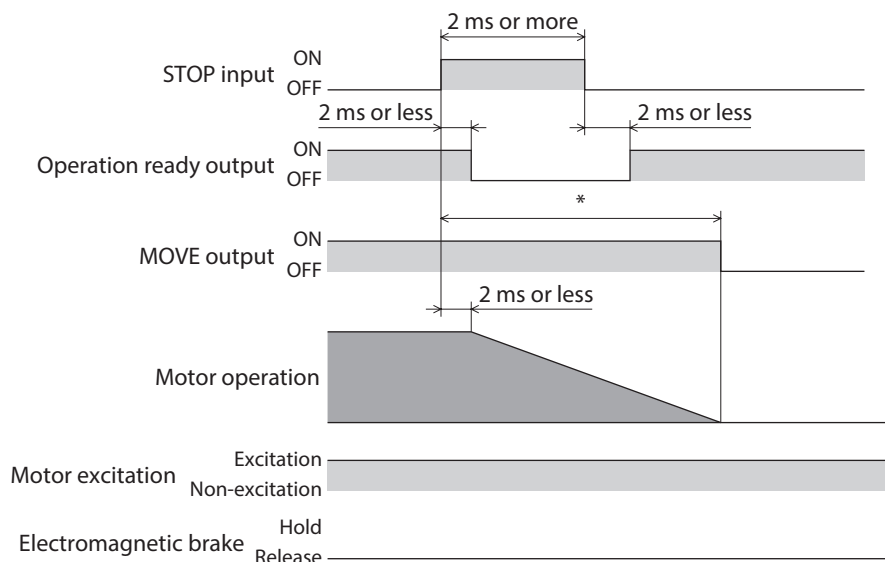

* It varies depending on the driving condition.

● **When the stopping movement by the STOP input is "Immediate stop"**

1. When the STOP input is turned ON during operation, the operation ready output is turned OFF and the motor starts the stopping movement.
The motor stops at the demand position at the time when the ON status of the STOP input was detected.
2. When the STOP input is turned OFF, the operation ready output is turned ON.

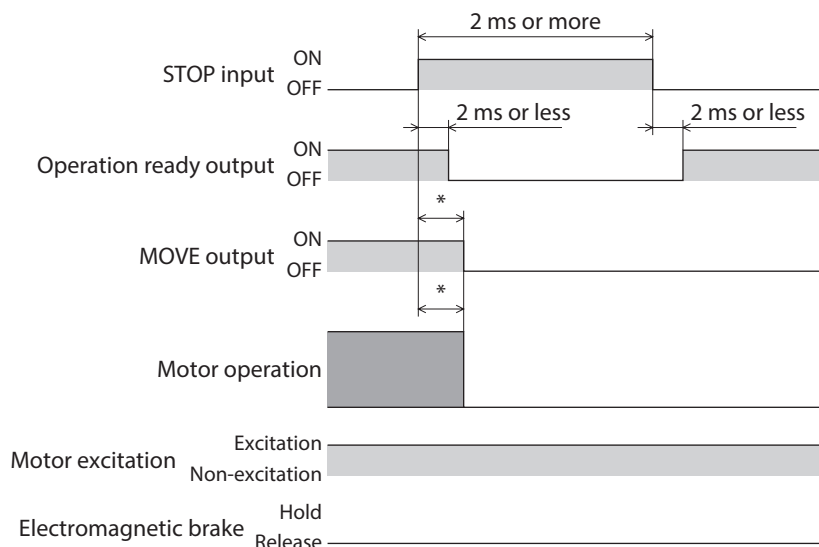

* It varies depending on the driving condition.

■ QSTOP input

Turning the QSTOP input ON causes the motor to stop.

The operation is stopped according to the "QSTOP input action" parameter.

The torque limiting value when stopped is based on the "QSTOP input stopping Torque limit value" parameter.

The remaining travel amount is cleared if positioning operation is being executed.

Related parameters

Parameter name	Description	Initial setting	
		Initial value	Unit
QSTOP input action	Sets how to stop the motor when the QSTOP input is turned ON. [Setting range] -3: Deceleration time stop (according to the Custom stopping time parameter) -2: Deceleration rate stop (according to the Custom stopping rate parameter) -1: Immediate stop 0: Immediate stop (current is cut off after stopping) 1: Deceleration stop (according to the operation profile during operation except for the torque limiting value) (current is cut off after stopping) 2: Deceleration rate stop (according to the Quick stop rate parameter) (current is cut off after stopping) 5: Deceleration stop (according to the operation profile during operation except for the torque limiting value) 6: Deceleration rate stop (according to the Quick stop rate parameter)	2	–
QSTOP input stopping Torque limiting value	Sets the torque limiting value when the QSTOP input is turned ON. [Setting range] 0: Use profile torque limit continuously 1 to 10,000 (1=0.1%)	0	1=0.1%
Quick stop rate	Sets the deceleration rate when "Deceleration rate stop (according to the Quick stop rate parameter)" is selected in the "STOP input action" and "QSTOP input action" parameters. [Setting range] 1 to 1,000,000,000 (User-defined velocity unit/s)	1,000	(r/min)/s
Custom stopping rate	Sets the deceleration rate when "Deceleration rate stop (according to the Custom stopping rate parameter)" is selected in the "STOP input action" and "QSTOP input action" parameters. [Setting range] 1 to 1,000,000,000 (User-defined velocity unit/s)	1,000	(r/min)/s
Custom stopping time	Sets the deceleration time when "Deceleration time stop (according to the Custom stopping time parameter)" is selected in the "STOP input action" and "QSTOP input action" parameters. [Setting range] 1 to 1,000,000,000 ms	1,000	ms
Timeout of waiting for motor rotation stop at standstill *	Sets the timeout period from when the velocity demand becomes zero at standstill until the motor actually stops rotating. When the timeout occurs, the MOVE output is turned OFF. [Setting range] -1: No timeout setting 0 to 32,767 ms	1,000	ms

* It is effective for the driver version 3.00 or later.

● **When the stopping movement by the QSTOP input is other than "Immediate stop" (when the motor stops while the QSTOP input is ON)**

1. When the QSTOP input is turned ON during operation, the operation ready output is turned OFF and the motor starts the stopping movement.
2. When the QSTOP input is turned OFF, the operation ready output is turned ON.

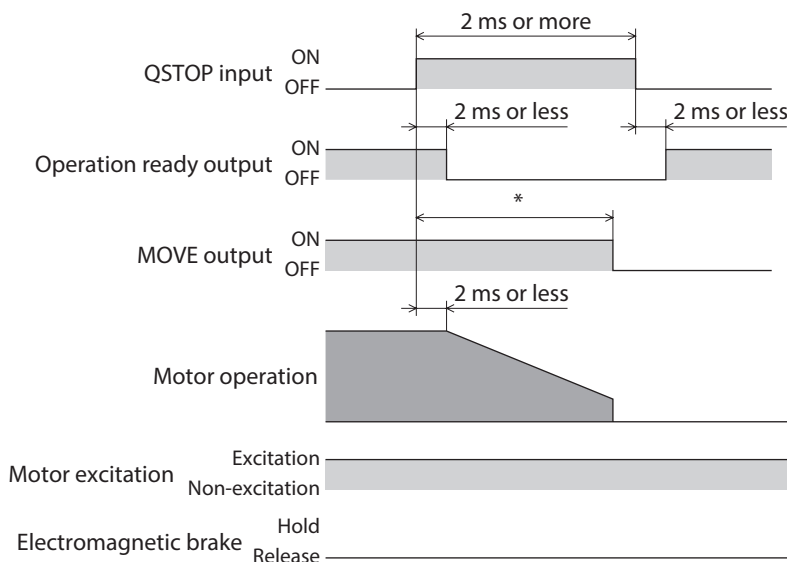
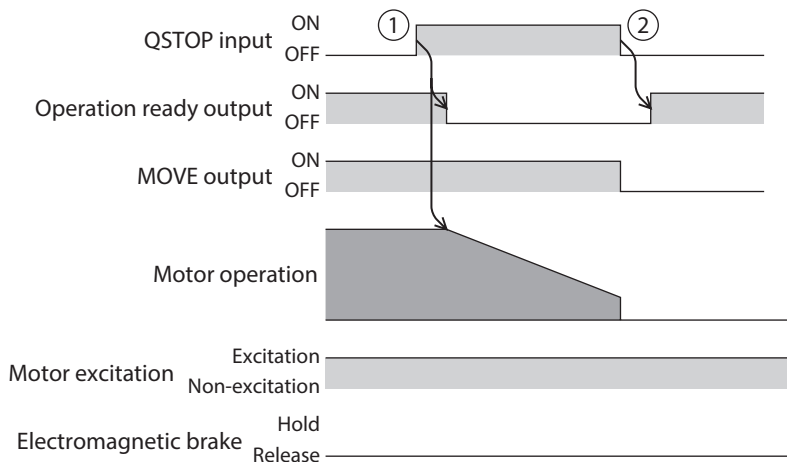

* It varies depending on the driving condition.

● **When the stopping movement by the QSTOP input is other than "Immediate stop" (when the motor does not stop while the QSTOP input is ON)**

1. When the QSTOP input is turned ON during operation, the operation ready output is turned OFF and the motor starts the stopping movement.
Even after the QSTOP input was turned OFF, the motor continues the deceleration operation until it stops.
2. When the QSTOP input is turned OFF, the operation ready output is turned ON.

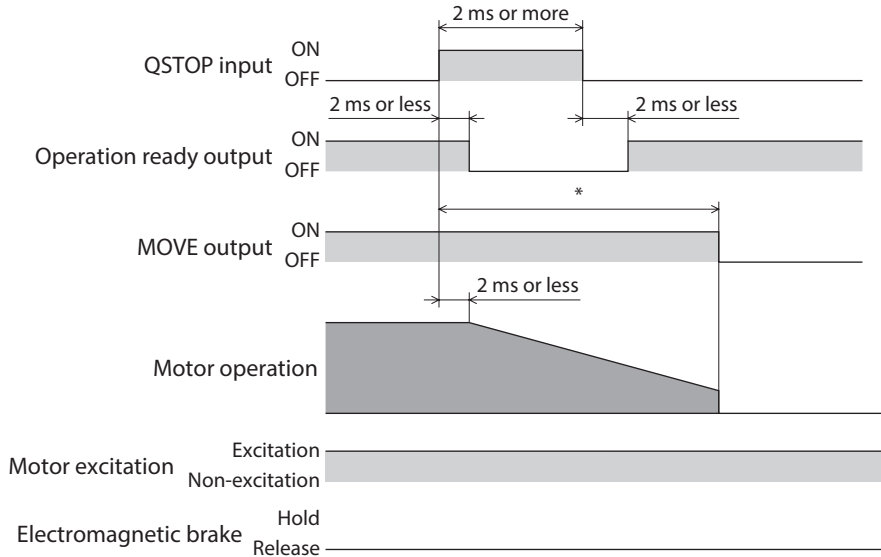

* It varies depending on the driving condition.

● **When the stopping movement by the QSTOP input is other than "Immediate stop" (when "current is cut off after stopping" is specified)**

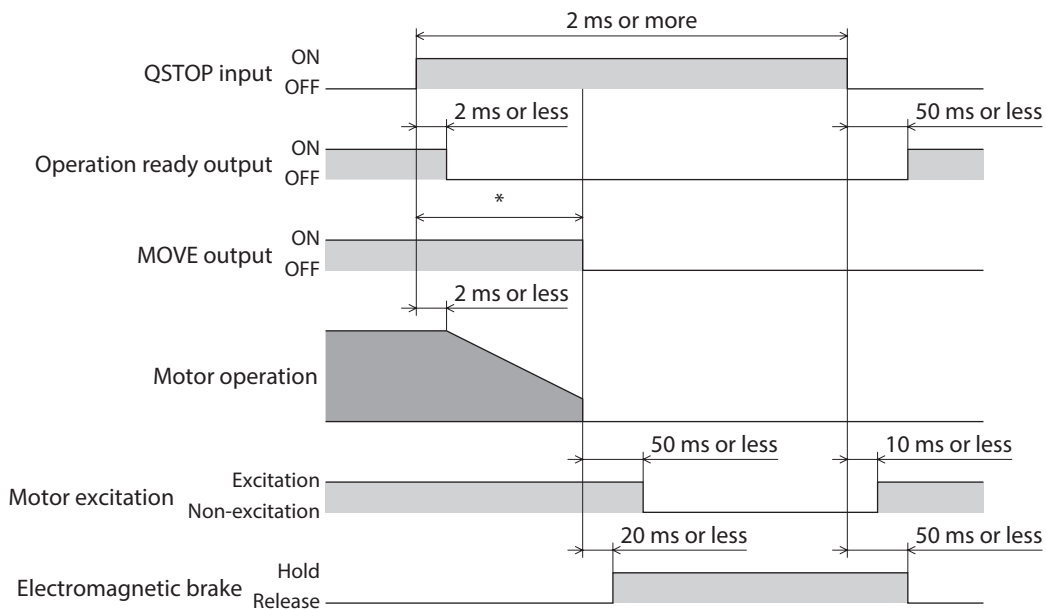

* It varies depending on the driving condition.

● When the stopping movement by the QSTOP input is "Immediate stop"

1. When the QSTOP input is turned ON during operation, the operation ready output is turned OFF and the motor starts the stopping movement.
The motor stops at the demand position at the time when the ON status of the QSTOP input was detected.
2. When the QSTOP input is turned OFF, the operation ready output is turned ON.

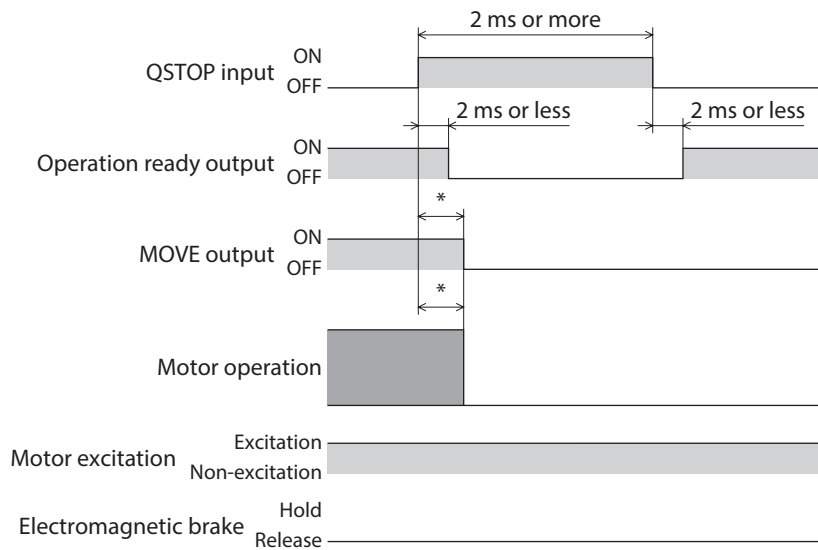

* It varies depending on the driving condition.

● When the stopping movement by the QSTOP input is "Immediate stop" (when "current is cut off after stopping" is specified)

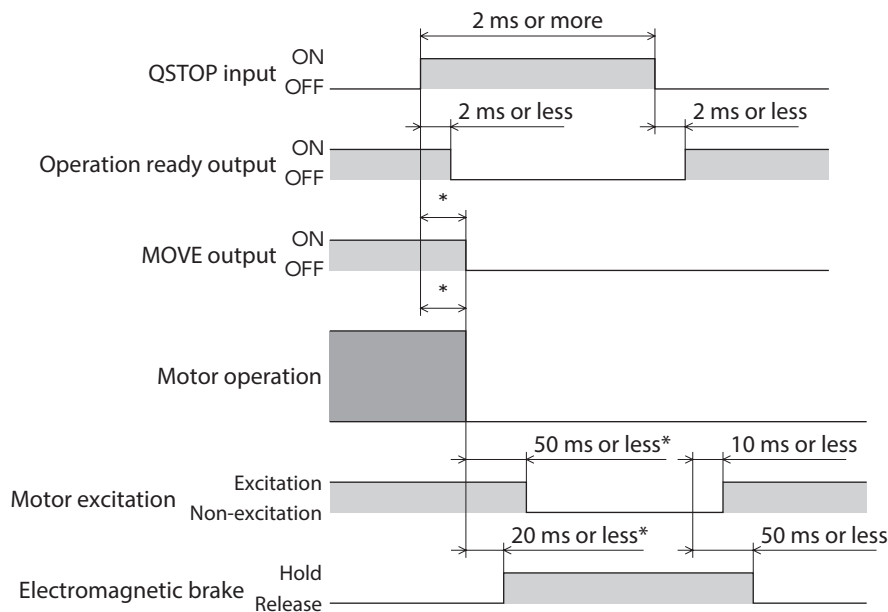

* It varies depending on the driving condition.

■ FW-BLK input, RV-BLK input

Turning the FW-BLK input ON causes the operation in the forward direction to stop, and turning the RV-BLK input ON causes that in the reverse direction to stop. While an input that have stopped the operation is being ON, the motor will not operate even if an operation start signal to operate in the same direction as the stop signal is input. An operation start signal in the opposite direction can be used to operate.

Related parameter

Parameter name	Description	Initial setting	
		Initial value	Unit
FW-BLK/RV-BLK input action	Sets how to stop the motor when the FW-BLK input or the RV-BLK input is turned ON. [Setting Range] 0: Immediate stop 1: Deceleration stop (according to the operation profile during operation) 2: Follow QSTOP setting (current is not cut off) 3: Follow STOP setting	1	–
Timeout of waiting for motor rotation stop at standstill *	Sets the timeout period from when the velocity demand becomes zero at standstill until the motor actually stops rotating. When the timeout occurs, the MOVE output is turned OFF. [Setting range] –1: No timeout setting 0 to 32,767 ms	1,000	ms

* It is effective for the driver version 3.00 or later.



The following information is generated when the FW-BLK input or the RV-BLK input is turned ON.

- When the FW-BLK input is turned ON: "Forward operation prohibition"
- When the RV-BLK input is turned ON: "Reverse operation prohibition"

● When the stopping method by the FW-BLK/RV-BLK input is "Deceleration stop" (when the motor stops while the FW-BLK input is ON)

1. When the FW-BLK input is turned ON during operation in the forward direction, the motor starts the stopping movement.
2. When the operation is stopped, the MOVE output is turned OFF.
3. If an operation start signal in the reverse direction is input when the FW-BLK input is being ON, the MOVE output is turned ON and operation is started.

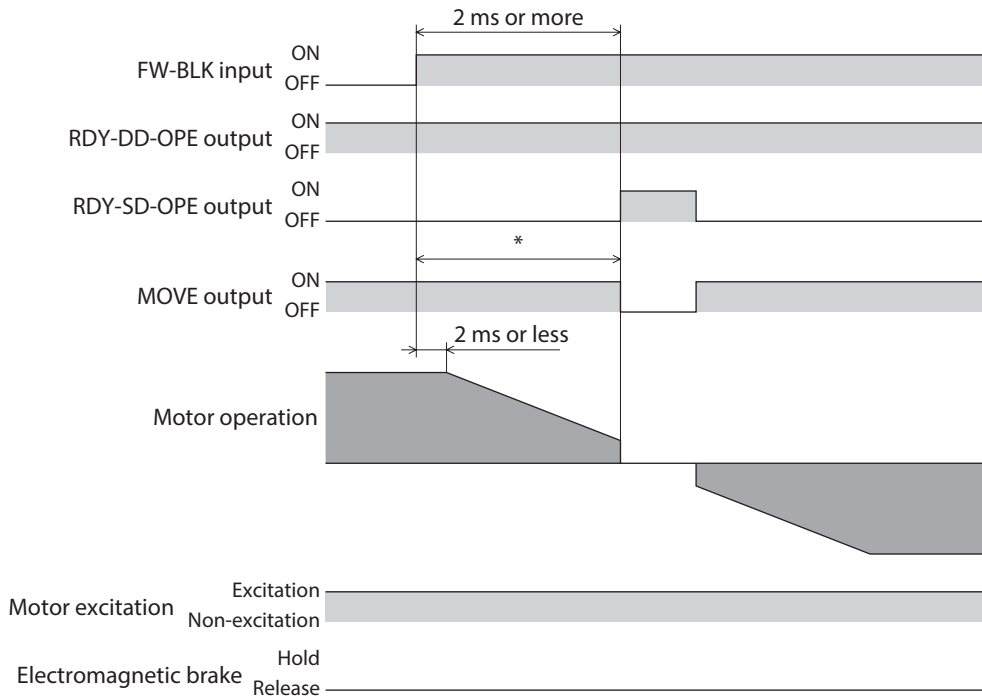
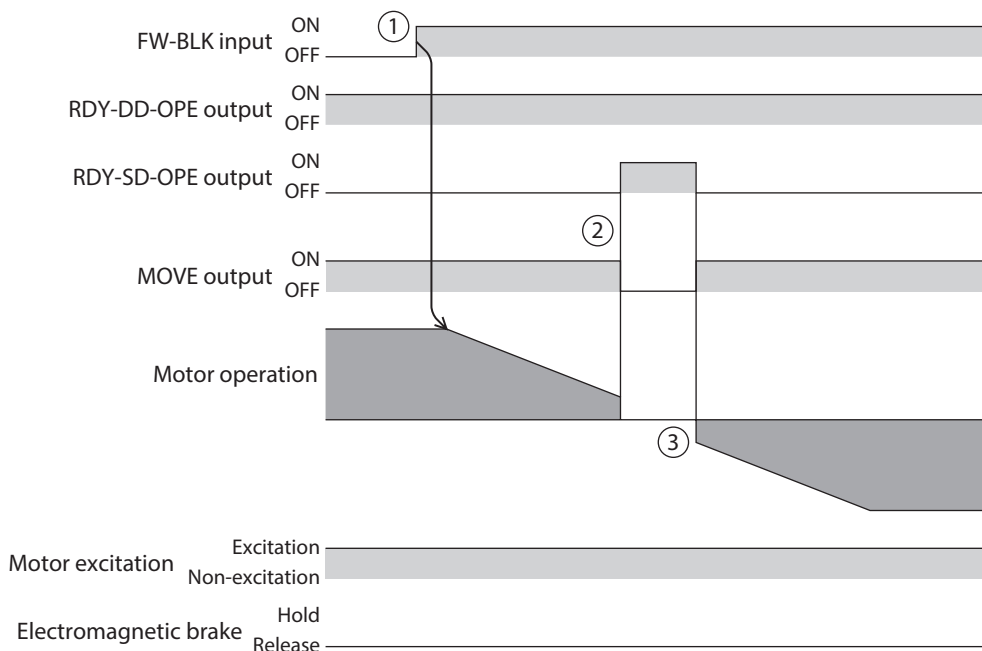

* It varies depending on the driving condition.

● **When the stopping method by the FW-BLK/RV-BLK input is "Deceleration stop" (when the motor does not stop while the FW-BLK input is ON)**

1. When the FW-BLK input is turned ON during operation in the forward direction, the motor starts the stopping movement.
2. Even after the FW-BLK input is turned OFF, the motor continues the deceleration operation until it stops. When the operation is stopped, the MOVE output is turned OFF.

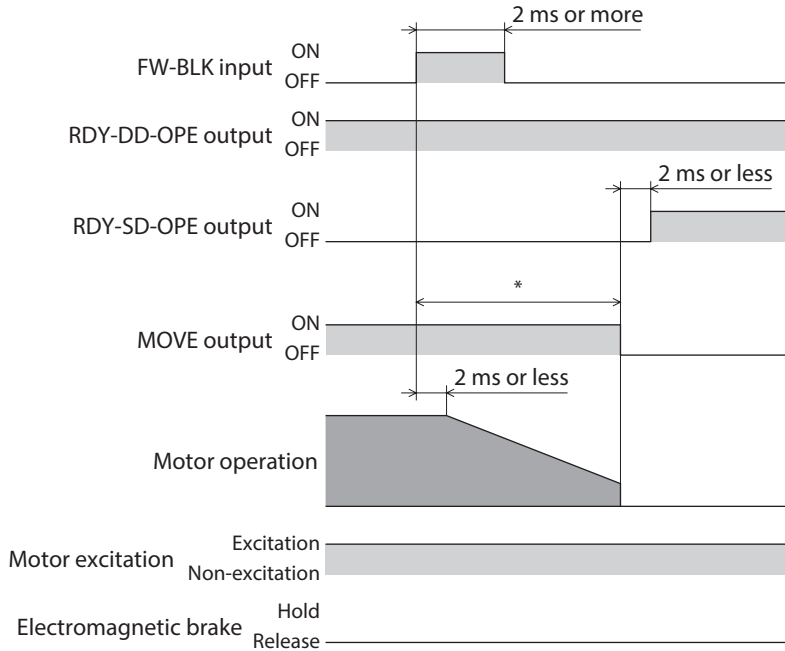

* It varies depending on the driving condition.

● **When the stopping method by the FW-BLK/RV-BLK input is "Immediate stop"**

1. When the FW-BLK input is turned ON during operation in the forward direction, the motor stops.
2. The motor stops at the demand position at the time when the ON status of the FW-BLK input was detected.

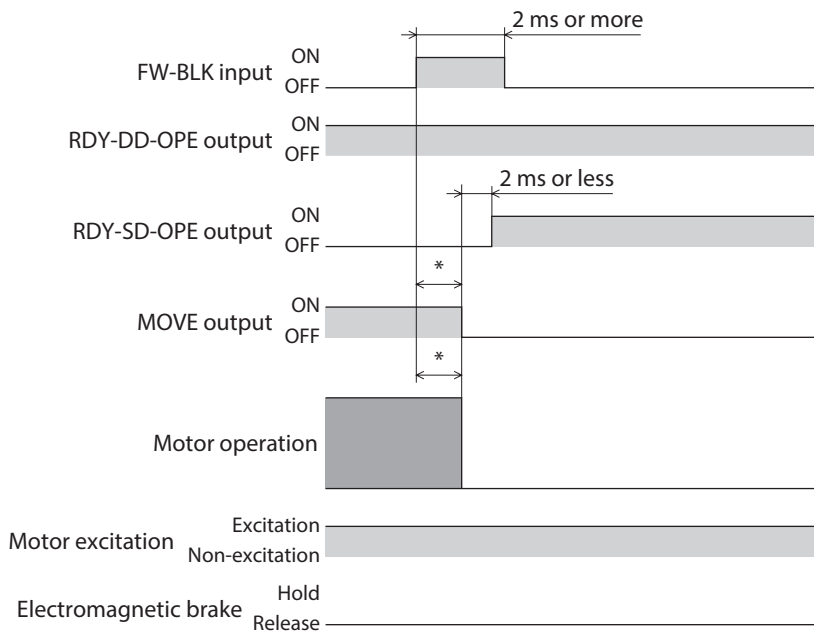

* It varies depending on the driving condition.

4-3 Signals used for stored data operation

■ BREAK-ATSQ input

The operation is switched from automatic sequential to manual sequential while the BREAK-ATSQ input is ON.

■ START input

When the operation data number is selected to turn the START input ON, stored data operation is started.
In the case of manual sequential operation, the operation data number to be the starting point is started.

■ SSTART input

When the SSTART input is turned ON, stored data operation is started.

In manual sequential operation, operation of the next operation data number linked is started every time the SSTART input is turned ON.

In other than manual sequential operation, operation of the operation data number selected is started.

■ D-SEL0 to D-SEL15 inputs

When any of the D-SEL0 to D-SEL15 inputs is turned ON, stored data operation based on the operation data number set is executed.

Since stored data operation can be performed only by turning any of the D-SEL0 to D-SEL15 inputs ON, the steps of selecting the operation data number can be saved.

Related parameters

Parameter name	Description	Initial setting	
		Initial value	Unit
D-SEL drive start function	Sets whether to start operation when the D-SEL input is turned ON. [Setting range] 0: Operation data number selection only 1: Operation data number selection + START function	1	–
D-SEL0 operation number selection	Sets the operation data number corresponding to the D-SEL input. [Setting range] 0 to 255: Operation data number	0	–
D-SEL1 operation number selection		1	–
D-SEL2 operation number selection		2	–
D-SEL3 operation number selection		3	–
D-SEL4 operation number selection		4	–
D-SEL5 operation number selection		5	–
D-SEL6 operation number selection		6	–
D-SEL7 operation number selection		7	–
D-SEL8 operation number selection		8	–
D-SEL9 operation number selection		9	–
D-SEL10 operation number selection		10	–
D-SEL11 operation number selection		11	–
D-SEL12 operation number selection		12	–
D-SEL13 operation number selection		13	–
D-SEL14 operation number selection		14	–
D-SEL15 operation number selection		15	–

■ M0 to M7 inputs

Select a desired operation data number for stored data operation or FW/RV operation based on a combination of ON-OFF status of the M0 to M7 inputs.

If the "Torque limit setting at motor standstill" parameter is "Follow the selection number," the torque limiting when the motor stopped can also be selected.

Operation data number	M7	M6	M5	M4	M3	M2	M1	M0
0	OFF	OFF	OFF	OFF	OFF	OFF	OFF	OFF
1	OFF	OFF	OFF	OFF	OFF	OFF	OFF	ON
2	OFF	OFF	OFF	OFF	OFF	OFF	ON	OFF
3	OFF	OFF	OFF	OFF	OFF	OFF	ON	ON
⋮	⋮	⋮	⋮	⋮	⋮	⋮	⋮	⋮
252	ON	ON	ON	ON	ON	ON	OFF	OFF
253	ON	ON	ON	ON	ON	ON	OFF	ON
254	ON	ON	ON	ON	ON	ON	ON	OFF
255	ON	ON	ON	ON	ON	ON	ON	ON

Related parameter

Parameter name	Description	Initial setting	
		Initial value	Unit
Torque limit setting at motor standstill	Selects the operating torque limit when the motor stops. [Setting range] 0: Follow the selection number 1: Maintain the previous operating torque limit (reset by excitation OFF)	1	–

Setting example 1: When the operation data No.8 (binary number: 0000 1000) is specified

Operation data number	M7	M6	M5	M4	M3	M2	M1	M0
8	OFF	OFF	OFF	OFF	ON	OFF	OFF	OFF

Setting example 2: When the operation data No.116 (binary number: 0111 0100) is specified

Operation data number	M7	M6	M5	M4	M3	M2	M1	M0
116	OFF	ON	ON	ON	OFF	ON	OFF	OFF

■ NEXT input

If the NEXT input is turned ON during operation, operation is forcibly transitioned to the operation data number linked. If the next data number is not set, the present operation is continued. This is a signal necessary when performing a different operation on the way of continuous operation or push-motion operation.

4-4 Signals used for FW/RV operation

■ FW-JOG input, RV-JOG input

Turning the FW-JOG input ON performs JOG operation in the forward direction and turning the RV-JOG input ON performs JOG operation in reverse direction.

■ FW-JOG-H input, RV-JOG-H input

Turning the FW-JOG-H input ON performs high-speed JOG operation in the forward direction and turning the RV-JOG-H input ON performs high-speed JOG operation in the reverse direction.

■ FW-JOG-P input, RV-JOG-P input

Turning the FW-JOG-P input ON performs inching operation in the forward direction and turning the RV-JOG-P input ON performs inching operation in reverse direction.

■ FW-POS input, RV-POS input

When the operation data number is selected and the FW-POS input or the RV-POS input is turned ON, continuous operation (position control) is started at the operating velocity corresponding to the operation data number selected. Turning the FW-POS input ON rotates the motor in the forward direction and turning the RV-POS input ON rotates the motor in the reverse direction.

If the signal of the same rotation direction is turned ON while the motor decelerates to a stop, the motor accelerates again and continues operation.

If both the FW-POS and RV-POS inputs are turned ON, the motor decelerates to a stop.

When the operation data number is changed during continuous operation, the operating velocity is changed to that of the operation data number changed.

■ FW-SPD, RV-SPD input

When the operation data number is selected and the FW-SPD input or the RV-SPD input is turned ON, continuous operation (speed control) is started at the operating velocity corresponding to the operation data number selected. Turning the FW-SPD input ON rotates the motor in the forward direction and turning the RV-SPD input ON rotates the motor in the reverse direction.

If the signal of the same rotation direction is turned ON while the motor decelerates to a stop, the motor accelerates again and continues operation.

If both the FW-SPD and RV-SPD inputs are turned ON, the motor decelerates to a stop.

When the operation data number is changed during continuous operation, the operating velocity is changed to that of the operation data number changed.

■ FW-PSH, RV-PSH input

When the operation data number is selected and the FW-PSH input or the RV-PSH input is turned ON, continuous operation (push-motion) is started at the operating velocity corresponding to the operation data number selected. Turning the FW-PSH input ON rotates the motor in the forward direction and turning the RV-PSH input ON rotates the motor in the reverse direction.

If the signal of the same rotation direction is turned ON while the motor decelerates to a stop, the motor accelerates again and continues operation.

If both the FW-PSH and RV-PSH inputs are turned ON, the motor decelerates to a stop.

When the operation data number is changed during continuous operation, the operating velocity is changed to that of the operation data number changed.

4-5 Signal used for homing operation

■ HOME input

Turning the HOME input ON starts homing operation. When homing operation is completed and the motor stops, the HOME-END output is turned ON.

4-6 External sensor input signals

■ FW-LS input, RV-LS input

These are input signals from the limit sensors. The FW-LS input is a sensor in the forward direction and the RV-LS input is a sensor in the reverse direction.

● When returning to the home

When the FW-LS input or the RV-LS input is detected, homing operation is performed according to the setting of the "(HOME) Homing mode" parameter.

● Other than when returning to the home

The hardware overtravel is detected to stop the motor. When the "FW-LS/RV-LS input action" parameter is set to "Only for homing sensor," the motor does not stop.

Related parameter

Parameter name	Description	Initial setting	
		Initial value	Unit
FW-LS/RV-LS input action	Sets how to stop the motor when the FW-LS input or the RV-LS input is turned ON. [Setting Range] -1: Only for homing sensor 0: Immediate stop 1: Deceleration stop (according to the operation profile during operation) 2: Follow QSTOP setting (current is not cut off) 3: Follow STOP setting 4: Immediate stop with alarm 5: Deceleration stop with alarm (according to the operation profile during operation) 6: Follow QSTOP setting with alarm (current is not cut off) 7: Follow STOP setting with alarm	4	–
Timeout of waiting for motor rotation stop at standstill *	Sets the timeout period from when the velocity demand becomes zero at standstill until the motor actually stops rotating. When the timeout occurs, the MOVE output is turned OFF. [Setting range] -1: No timeout setting 0 to 32,767 ms	1,000	ms

* It is effective for the driver version 3.00 or later.

■ HOMES input

This is an input signal from the mechanical home sensor when the "(HOME) Homing mode" parameter is set to the 3-sensor mode or the one-way rotation mode.

■ SLIT input

Connect when returning to the home using a sensor with slit.

When executing homing operation, using the SLIT input simultaneously can increase the accuracy of home detection.

4-7 Coordinate preset signals

This signal is used to preset the mechanical home or the electrical home.

■ P-PRESET input

When the P-PRESET input is turned ON, the demand position and the actual position are changed to a value subtracted the value of the "Home offset" parameter, and the home is fixed.

Related parameter

Parameter name	Description	Initial setting	
		Initial value	Unit
Home offset	Sets the amount of offset from the home when homing operation is completed or P-PRESET is executed. [Setting range] -2,147,483,648 to 2,147,483,647 (User-defined position unit)	0	step



Preset by the P-RESET input cannot be executed during operation.

■ EL-PRST input

The coordinate system is switched to that with the electrical home as the home while the EL-PRST input is ON. The coordinate position when the EL-PRST input is turned from OFF to ON is the electrical home, and the motor operates in the electrical home coordinate system. Turning the EL-PRST input OFF returns to the coordinate system with the mechanical home as the home. Setting a different home (electrical home) from the mechanical home can control the motor in a different coordinate temporarily.

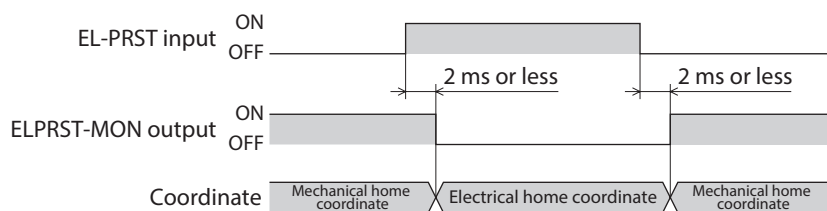

If the EL-PRST input is turned ON during operation, the demand position and the actual position at that time is set to the electrical home coordinate. However, the target position of the operation being executed remains at the position in the mechanical home coordinate system. Execute the operation in the electrical home coordinate system after stopping the operation.

4-8 Status releasing signals

These signals are used to release the signal or status that is not released automatically.

■ ALM-RST input

If an alarm is generated, the motor will stop. If the ALM-RST input is turned from OFF to ON at this time, the alarm will be reset (the alarm will be reset at the ON edge of the ALM-RST input). Be sure to remove the cause of the alarm and ensure safety before resetting the alarm.

Note that some alarms cannot be reset with the ALM-RST input.

Refer to "1-4 Alarms list" on p.432 for alarms.

■ ETO-CLR input

After both the HWTO1 and HWTO2 inputs are turned ON and the power removal status is released, if the ETO-CLR input is turned ON, the motor puts into an excitation state (when the S-ON input is ON).

Related parameter

Parameter name	Description	Initial setting	
		Initial value	Unit
ETO reset action (ETO-CLR)	Sets the judgment criterion of the signal when the ETO status is released by the ETO-CLR input. [Setting range] 1: ON edge (Positive edge) 2: ON level	1	—

■ LAT-CLR input

This signal is used to clear the latched status. The following information is cleared by the LAT-CLR input.

- Information latched by the USR-LAT0 output, the USR-LAT1 output, and the user latch input
- Information latched by the NEXT-LAT output and the NEXT input
- Information latched by the JUMP0-LAT output and the (Low) I/O event number
- Information latched by the JUMP1-LAT output and the (Middle) I/O event number
- Information latched by the JUMP2-LAT output and the (High) I/O event number
- Information latched by stop of operation
- Cumulative load value (When the "Cumulative load value auto clear" parameter is disabled)



Refer to "9 Latch function" on p.479 for details about latch information.

■ INFO-CLR input

This signal is enabled when the "Information auto clear" parameter is set to "Disable."

When the INFO-CLR input is turned ON, the information status is cleared.

4-9 Driver function change signals

■ HMI input

When the HMI input is turned ON, the function limitation of the support software is released. When the HMI input is turned OFF, the function limitation is imposed.

The following functions will be limited.

- Simple setting
- Remote operation
- I/O test
- Gain tuning
- Writing parameters, initializing
- Clearing various history items



- When the HMI input is not assigned to direct I/O or remote I/O, this input will always be set to ON. Also, when this input is assigned to both direct I/O and remote I/O, the function will be executed only when both of them are turned ON.
- When the HMI input is assigned to the DIN input function, do not set the "1 shot signal" parameter to "Enable."

■ TRQ-LMT input

When the TRQ-LMT input is turned ON, the torque is limited by the value set in the "TRQ-LMT input Torque limit value" parameter.

Related parameter

Parameter name	Description	Initial setting	
		Initial value	Unit
TRQ-LMT input Torque limit value	Sets the torque to be limited by the TRQ-LMT input. Set the percentage of the torque based on the rated torque being 100%. [Setting range] 0 to 10,000 (1=0.1%)	500	1=0.1%

■ SPD-LMT input

If the SPD-LMT input is turned ON, the operating velocity is limited.

Related parameters

Parameter name	Description	Initial setting	
		Initial value	Unit
SPD-LMT speed limit type selection	Selects the setting method of the speed limit value. [Setting range] 0: Ratio 1: Value	0	–
SPD-LMT speed limit ratio	Sets the percentage of the speed limit based on the "Operating velocity" of the operation profile being 100%. This is enabled when the "SPD-LMT speed limit type selection" parameter is set to "Ratio." [Setting range] 1 to 100%	50	%
SPD-LMT speed limit value	Sets the value of the operating velocity. This is enabled when the "SPD-LMT speed limit type selection" parameter is set to "Value." [Setting range] 1 to 4,000,000 (User-defined velocity unit)	1,000	r/min

■ PLOOP-MODE input

This signal is used to switch the position loop when stopped.

Turning the PLOOP-MODE input OFF disables the position loop, and turning it ON enables the position loop.

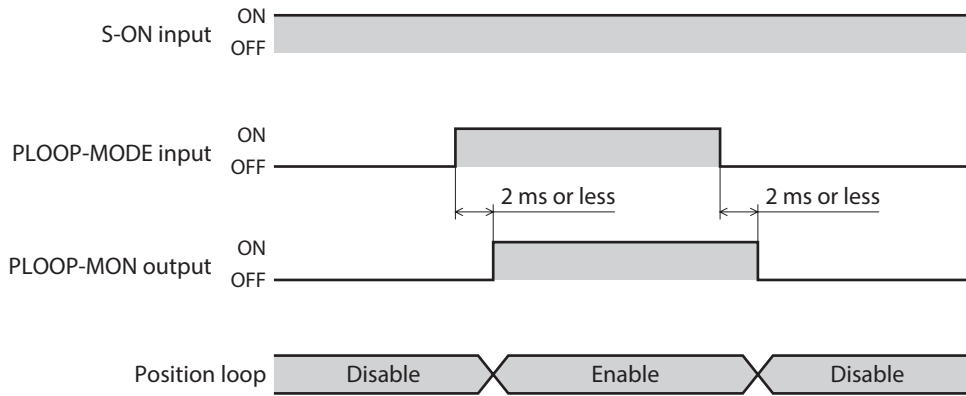

- The position loop is enabled when the motor is in an excitation state.
- Refer to "3-5 Operation type and position loop" on p.64 for relation between the operation type and the position loop.

■ ATL-EN input

This signal is used to switch the ATL function.

If the "ATL function mode setting" parameter is set to "Follow ATL-EN input," turning the ATL-EN input OFF disables the ATL function, and turning it ON enables the ATL function.

Refer to p.40 for details about the ATL function.

- When the "ATL function mode setting" parameter is set to "Follow ATL-EN input"

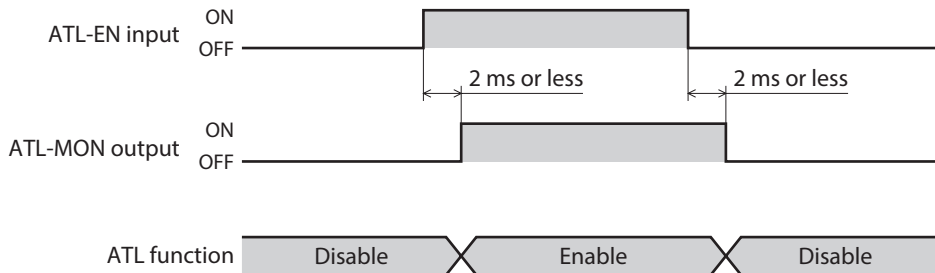

- When the "ATL function mode setting" parameter is set to "ATL function enabled"

The ATL-MON output is turned ON regardless of the status of the ATL-EN input.

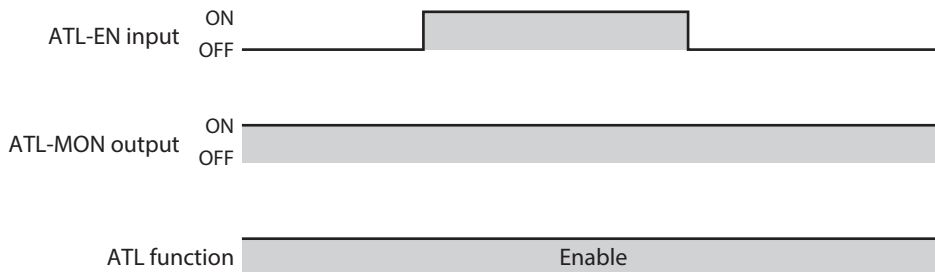

4-10 Communication setting change signals

■ ID-SEL0 to ID-SEL3 inputs

Select the following communication settings based on a combination of ON-OFF status of the ID-SEL0 to ID-SEL3 inputs.

- Address number setting of RS-485 communication
- Address number setting of CAN communication

Address number setting	ID-SEL3	ID-SEL2	ID-SEL1	ID-SEL0
1	OFF	OFF	OFF	OFF
2	OFF	OFF	OFF	ON
3	OFF	OFF	ON	OFF
4	OFF	OFF	ON	ON
5	OFF	ON	OFF	OFF
6	OFF	ON	OFF	ON
7	OFF	ON	ON	OFF
8	OFF	ON	ON	ON
9	ON	OFF	OFF	OFF
10	ON	OFF	OFF	ON
11	ON	OFF	ON	OFF
12	ON	OFF	ON	ON
13	ON	ON	OFF	OFF
14	ON	ON	OFF	ON
15	ON	ON	ON	OFF
16	ON	ON	ON	ON

Timing chart

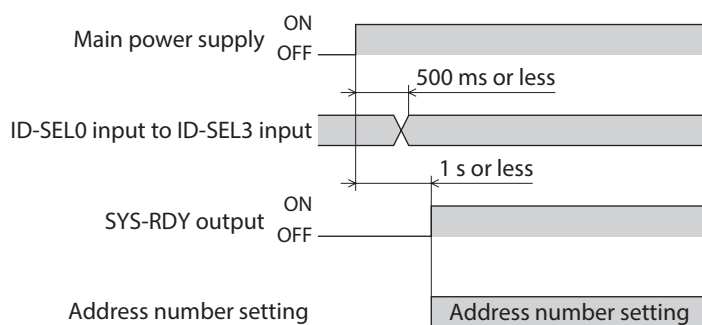

Even when the "Communication reset" of the maintenance command is executed to reset the communication, the address number setting can be changed.

Related parameters

Parameter name	Description	Initial setting	
		Initial value	Unit
Slave address (Modbus)	Sets the address number (slave address). [Setting range] -1: Follow ID-SEL input (ID = ID-SEL value + 1) 1 to 31: Slave addresses 1 to 31 ※ Do not use 0.	-1	-
CANopen Node-ID	Sets the CANopen Node-ID. [Setting range] -1: Follow ID-SEL input (ID = ID-SEL + 1) 0 to 127: Node-ID 0 to 127	-1	-

4-11 Latch input signals

■ USR-LAT-IN0, USR-LAT-IN1 inputs

These signals can be used as inputs for user latches (USR-LAT0, USR-LAT1).

Related parameters

Parameter name	Description	Initial setting	
		Initial value	Unit
USR-LAT0 action	Selects the movement of the latch by USR-LAT0. [Setting range] 0: 1 shot 1: Continuous	0	–
USR-LAT1 action	Selects the movement of the latch by USR-LAT1. [Setting range] 0: 1 shot 1: Continuous	0	–
USR-LAT0 source	Selects the input source of USR-LAT0. [Setting range] 0: IO for latch (USR-LAT-IN0) 1: Phase Z (ZSG-N)	0	–
USR-LAT1 source	Selects the input source of USR-LAT1. [Setting range] 0: IO for latch (USR-LAT-IN1) 1: Phase Z (ZSG-N)	0	–



Refer to p.479 for details about the latch function.

4-12 User alarm input signal

■ USR-ALM input

When the USR-ALM input is turned ON, the user alarm will be generated.

When the user alarm is generated, the motor excitation state after stop is based on the setting in the "User alarm action" parameter.

Refer to p.428 for the alarm function.

Related parameters

Parameter name	Description	Initial setting	
		Initial value	Unit
User alarm action	Sets whether or not to excite the motor after stop when the user alarm is generated. [Setting range] 0: Non-excitation after deceleration 1: Excitation	0	–



The USR-ALM input and the "User alarm action" parameter are effective for the driver version 3.00 or later.

5 Output signals

5-1 Driver status indication signals

■ ALM-A output, ALM-B output

If an alarm is generated, the ALM-A output is turned ON and the ALM-B output is turned OFF. At the same time, the PWR/SYS LED on the driver will blink in red, and the motor will stop. When an alarm to turn the motor excitation OFF is generated, the motor puts into a non-excitation state after it stops.

The ALM-A output is normally open and the ALM-B output is normally closed.

■ SYS-RDY output

When signal input is enabled after the main power supply is turned on, the SYS-RDY output is turned ON.

■ INFO output

If information is generated, the INFO output is turned ON.

Related parameter

Parameter name	Description	Initial setting	
		Initial value	Unit
Information auto clear	When the condition to clear the information is satisfied, a bit output of the corresponding information is automatically turned OFF. [Setting range] 0: Disable 1: Enable	1	–

■ SYS-BSY output

This signal is turned ON while the driver executes the maintenance command via communication.

■ Output of information signal

If corresponding information is generated, each output signal is turned ON.
Refer to "2-4 Information list" on p.451 for details about information.

5-2 Hardware status indication

■ SON-MON output

The SON-MON output is turned ON while the motor is in an excitation state.

■ MAIN-PWR output

The MAIN-PWR output is turned ON when the main power supply is turned on.

■ COMM-PWR output

The COMM-PWR output is turned ON when the power supply for communication is turned on.

■ MBC output

Use this signal when controlling the electromagnetic brake by the host controller.

The MBC output is ON when the driver's command is in a state of releasing the electromagnetic brake, and it is OFF when the driver's command is in a state of actuating the electromagnetic brake to hold the motor shaft.

Detect the ON-OFF status of the MBC output using the host controller, and control the electromagnetic brake.

5-3 Operation status indication

■ MOVE output

The MOVE output is turned ON while the motor is operating.

If positioning operation is performed, it is turned OFF when the command is completed. (After command filter)

If operation is stopped by stop operation or an operation stop signal, it is turned OFF when the motor rotation is actually stopped.

The driver determines that the motor rotation is stopped when the actual velocity becomes zero or the ZV output is turned ON.

Related parameter

Parameter name	Description	Initial setting	
		Initial value	Unit
MOVE minimum ON time	Sets the minimum time during which the MOVE output remains ON. [Setting range] 0 to 255 ms	0	ms
Timeout of waiting for motor rotation stop at standstill *	Sets the timeout period from when the velocity demand becomes zero at standstill until the motor actually stops rotating. When the timeout occurs, the MOVE output is turned OFF. [Setting range] -1: No timeout setting 0 to 32,767 ms	1,000	ms

* It is effective for the driver version 3.00 or later.

■ OPE-BSY output

The OPE-BSY output is turned ON while the driver is executing internal oscillation.

Internal oscillation is executed during the following operation.

- Direct data operation
- Stored data operation
- FW/RV operation
- Homing operation
- Operation via CAN communication (drive profile)

■ IN-POS output

After completion of positioning operation, when the difference (position deviation) between the demand position and the actual position was converged in a value of the "IN-POS positioning completion signal range" parameter, the IN-POS output is turned ON.

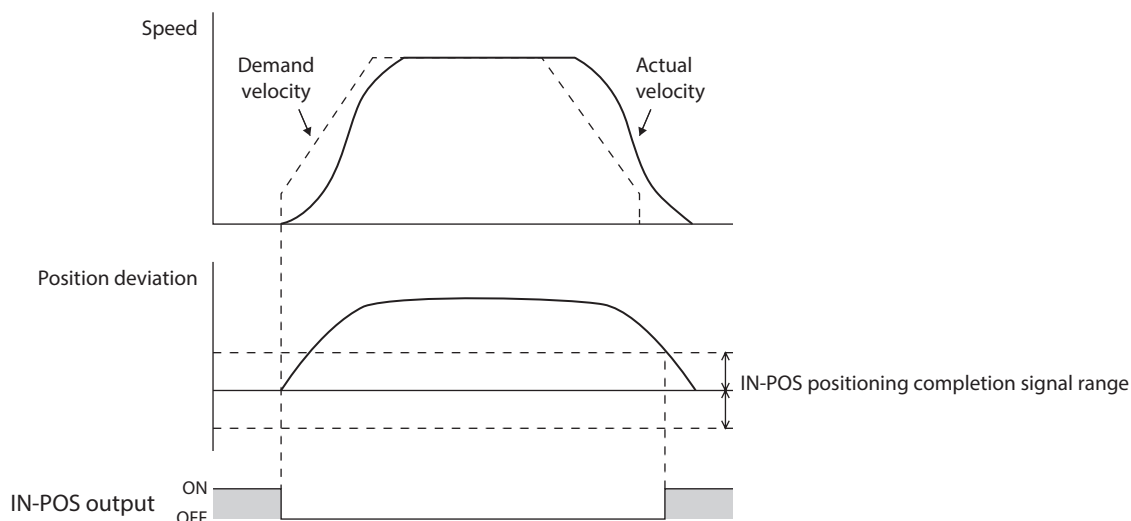

Related parameter

Parameter name	Description	Initial setting	
		Initial value	Unit
IN-POS positioning completion signal range	Sets the output range (one side) of the IN-POS output with the target position as a center. [Setting range] 0 to 65,535 (User-defined position unit)	18	step



- When continuous operation is stopped, or when operation is interrupted by the STOP input or other operation stop signals, the IN-POS output is not turned ON.
- During speed control, there is a possibility that the IN-POS output will not be turned ON because the steady-state deviation of the position remains even after the completion of operation depending on a load and an operating condition.
- The IN-POS output may be turned ON and OFF repeatedly if the setting value is small or depending on a load or an operating condition.

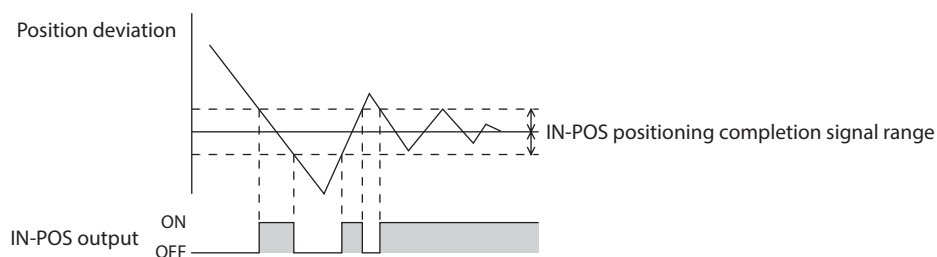

■ TLC output

When the output torque reaches the maximum output torque of the motor, the TLC output is turned ON. If the torque limiting value is set to a value smaller than the maximum output torque, the TLC output is turned ON when the output torque reaches the torque limiting value.



Refer to p.39 for the torque limiting function.

■ **VA output**

This signal is turned ON when the operating velocity reaches the target velocity. The judgment level can be set using the "VA mode selection" parameter.

● **When the "VA mode selection" parameter is set to "Actual velocity attainment"**

When the motor actual velocity is in the setting range of the "VA detection speed range" parameter with the demand velocity as a center, the VA output is turned ON.

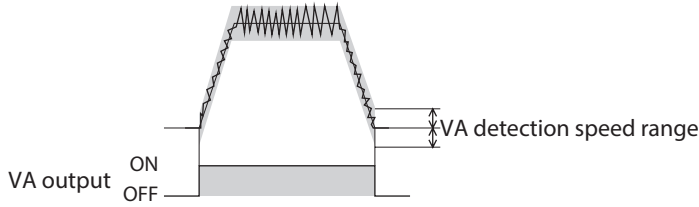

● **When the "VA mode selection" parameter is set to "Profile demand velocity attainment"**

When the motor demand velocity matches the target velocity, the VA output is turned ON.

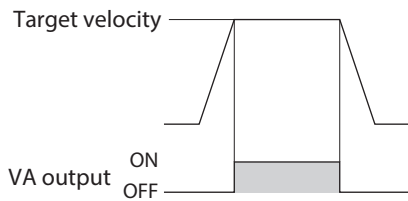

● **When the "VA mode selection" parameter is set to "Velocity attainment (actual velocity & profile demand velocity)"**

When the motor actual velocity is in the setting range of the "VA detection speed range" parameter with the target velocity as a center, the VA output is turned ON.

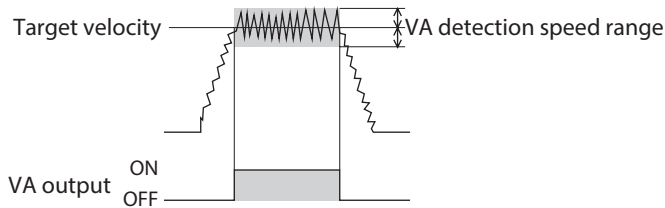

Related parameters

Parameter name	Description	Initial setting	
		Initial value	Unit
VA mode selection	Selects the judgment criterion of the VA output. [Setting range] 0: Actual velocity attainment 1: Profile demand velocity attainment 2: Velocity attainment (actual velocity & profile demand velocity)	0	–
VA detection speed range	Sets the output range (one side) of the VA output with the target velocity as a center. [Setting range] 0 to 65,535 (User-defined velocity unit)	15	r/min

■ ZV output

When the actual velocity is equal to or less than the "ZV detection speed range" parameter with the velocity 0 as a center, the ZV output is turned ON.

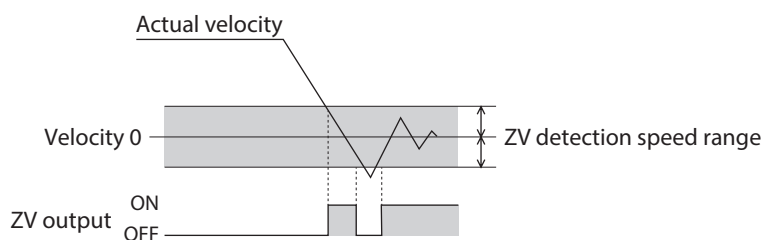

Related parameter

Parameter name	Description	Initial setting	
		Initial value	Unit
ZV detection speed range	Sets the output range (one side) of the ZV output with the operating velocity 0 as a center. [Setting range] 0 to 65,535 (User-defined velocity unit)	15	r/min

■ SLIP output

This signal is output when a slip occurs in the motor.

When the SLIP output turned ON while positioning operation is used, check if the target position has been reached.

■ TRQ-LMTD output

This signal is output when the motor output torque reaches the torque limiting value by the TRQ-LMT input.

The TRQ-LMTD output is turned ON when all of the following conditions are satisfied.

- The TRQ-LMT input is ON.
- The motor output torque reaches the value set in the "TRQ-LMT input Torque limit value" parameter.

Related parameter

Parameter name	Description	Initial setting	
		Initial value	Unit
TRQ-LMT input Torque limit value	Sets the torque to be limited by the TRQ-LMT input. Set the percentage of the torque based on the rated torque being 100%. [Setting range] 0 to 10,000 (1=0.1%)	500	1=0.1%

■ SPD-LMTD output

This signal is enabled when the speed limit is performed. If the operating velocity increases equal to or higher than the value set in the "SPD-LMT speed limit ratio" parameter or the "SPD-LMT speed limit value" parameter, the operating velocity is limited to turn the SPD-LMTD output ON.

Related parameters

Parameter name	Description	Initial setting	
		Initial value	Unit
SPD-LMT speed limit type selection	Selects the setting method of the speed limit value. [Setting range] 0: Ratio 1: Value	0	–
SPD-LMT speed limit ratio	Sets the percentage of the speed limit based on the "Operating velocity" of the operation profile being 100%. This is enabled when the "SPD-LMT speed limit type selection" parameter is set to "Ratio." [Setting range] 1 to 100%	50	%
SPD-LMT speed limit value	Sets the value of the operating velocity. This is enabled when the "SPD-LMT speed limit type selection" parameter is set to "Value." [Setting range] 1 to 4,000,000 (User-defined velocity unit)	1,000	r/min

■ OL-DTCT output

When the output torque reaches the torque to detect the overload alarm, the OL-DTCT output is turned ON. Refer to p.442 for detection of the overload alarm.

■ HOME-END output

The HOME-END output is turned ON at the following conditions.

- When homing operation is completed
- When the position preset is executed and coordinates are set

■ M-CHG output

The ON-OFF status of the M-CHG output is inverted at the following cases. (Toggle action) *

- When operation is started
- When the operation data number is switched during operation
- When the operation data is rewritten (override)

* In the case of operations other than stored data operation and continuous operation of FW/RV operation, it is effective for the driver version 3.00 or later.

■ M-ACT0 to M-ACT7 outputs

These signals are enabled in operations that operation data is used such as stored data operation and continuous operation of FW/RV operation.

The operation data number presently being operated is output in binary.

The status of the signal output in the previous operation is maintained in operations that operation data is not used such as homing operation and JOG operation.

■ D-END0 to D-END15 outputs

These signals are enabled in operations that operation data is used such as stored data operation and continuous operation of FW/RV operation.

They are turned OFF when operation is started and ON when the operation of the specified operation data number is completed.

Use them to check each operation has been completed during link operation.

Related parameters

Parameter name	Description	Initial setting	
		Initial value	Unit
D-END0 operation number selection	Sets the operation data number corresponding to the D-END output. [Setting range] 0 to 255: Operation data number	0	–
D-END1 operation number selection		1	–
D-END2 operation number selection		2	–
D-END3 operation number selection		3	–
D-END4 operation number selection		4	–
D-END5 operation number selection		5	–
D-END6 operation number selection		6	–
D-END7 operation number selection		7	–
D-END8 operation number selection		8	–
D-END9 operation number selection		9	–
D-END10 operation number selection		10	–
D-END11 operation number selection		11	–
D-END12 operation number selection		12	–
D-END13 operation number selection		13	–
D-END14 operation number selection		14	–
D-END15 operation number selection		15	–

5-4 Operation ready indication

■ RDY-DD-OPE output

When direct data operation is ready to start, the RDY-DD-OPE output is turned ON.
Execute direct data operation after the RDY-DD-OPE output is turned ON.

■ RDY-SD-OPE output

When stored data operation is ready to start, the RDY-SD-OPE output is turned ON.
Execute stored data operation after the RDY-SD-OPE output is turned ON.

■ RDY-FWRV-OPE output

When FW/RV operation is ready to start, the RDY-FWRV-OPE output is turned ON.
Execute FW/RV operation after the RDY-FWRV-OPE output is turned ON.

■ RDY-HOME-OPE output

When homing operation is ready to start, the RDY-HOME-OPE output is turned ON.
Execute homing operation after the RDY-HOME-OPE output is turned ON.

[ON condition of operation ready output]

The operation ready output is turned ON when all of applicable conditions shown in the table are satisfied.

Condition	RDY-DD-OPE	RDY-SD-OPE	RDY-FWRV-OPE	RDY-HOME-OPE
The main power supply is turned on.	Applicable	Applicable	Applicable	Applicable
The S-ON input is ON.	Applicable	Applicable	Applicable *1	Applicable
The STOP input is OFF.	Applicable	Applicable	Applicable	Applicable
The QSTOP input is OFF.	Applicable	Applicable	Applicable	Applicable
The CLR input is OFF.	Applicable	Applicable	Applicable	Applicable
The FREE input is OFF.	Applicable	Applicable	Applicable	Applicable
An alarm is not present.	Applicable	Applicable	Applicable	Applicable
The driver is not in the ETO status.	Applicable	Applicable	Applicable	Applicable
Remote operation, data writing, or I/O test is not executed with the support software.	Applicable	Applicable	Applicable	Applicable
"Configuration" command, "Batch data initialization" command, "All data batch data initialization" command, and "Read batch NV memory" command are not executed via communication.	Applicable	Applicable	Applicable	Applicable
Direct data operation is not executed.	Not applicable	Applicable	Applicable	Applicable
Stored data operation is not executed.	Applicable	Applicable *2	Applicable	Applicable
FW/RV operation is not executed.	Applicable	Applicable	Applicable	Applicable
Homing operation is not executed.	Applicable	Applicable	Applicable	Applicable
Drive profile (CAN communication) is not executed.	Applicable	Applicable	Applicable	Applicable
All inputs which start operation are OFF.	Applicable	Applicable	Applicable	Applicable

*1 If the "Automatic S-ON for the FW/RV operation" parameter is set to "Enable", it is not applicable.

*2 If the "Accept stored data override operation start by START input" parameter is set to "Enable", it is not applicable.

■ RDY-DPROF-OPE output

When the drive profile (CAN communication) is ready to start, the RDY-DPROF-OPE output is turned ON.

5-5 Direct data operation status indication

■ DDBUF-FULL output

The DDBUF-FULL output is turned ON when data is being written to the buffer area of direct data operation or drive profile.

 Refer to p.81 to p.82 for details about DDBUF-FULL output.

5-6 Stored data operation status indication

■ SEQ-BSY output

The SEQ-BSY output is turned ON while stored data operation is being performed.

■ DELAY-BSY output

The DELAY-BSY output is turned ON when the driver is in a state of the waiting time after operation (drive-complete delay time) or the standby state (Dwell).

■ MAREA output

The MAREA output is turned ON when the motor is inside the set area.

Related parameter

Parameter name	Description	Initial setting	
		Initial value	Unit
MAREA output source	Sets the criterion to turn the MAREA output ON and the status of the MAREA output after operation. [Setting range] 0: Based on actual position (ON after operation) 1: Based on demand position (ON after operation) 2: Based on actual position (MAREA output OFF at completion) 3: Based on demand position (MAREA output OFF at completion)	0	–

Related operation data

Name	Description	Initial setting	
		Initial value	Unit
Area offset	Sets the distance from the center position of the range in which the MAREA output is turned ON to the target position of positioning operation. Sets the distance to the operation start position in the case of continuous operation. [Setting range] –2,147,483,648 to 2,147,483,647 (User-defined position unit)	0	step
Area width	Sets the range in which the MAREA output is turned ON. [Setting range] –1: Disable 0 to 4,194,303 (User-defined position unit)	–1	step

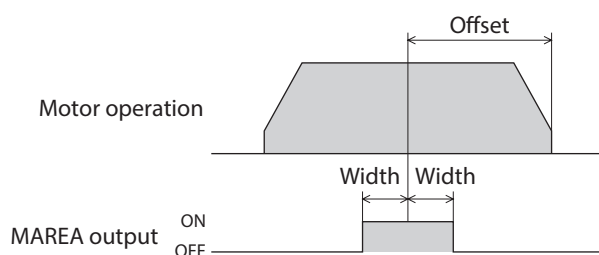

Setting Example 1: When MAREA is turned ON in a range of ± 10 steps with the position of 5,000 steps as a center in incremental positioning operation which travel distance is 10,000 steps.

- Area offset: –5,000 steps
- Area width: 10 steps

Setting Example 2: When MAREA is turned ON in a range of ± 100 steps with the coordinate 1,000 as a center in absolute positioning operation from the present position 5,000 to the target position –8,000 steps.

- Area offset: 9,000 steps
- Area width: 100 steps

5-7 Function status indication

■ CONST-OFF output

Output an OFF state all the time.

■ PLOOP-MON output

The PLOOP-MON output is turned ON when the position loop is enabled.

■ ATL-MON output

The ATL-MON output is turned ON when the ATL function is enabled.

5-8 Power removal function signals

■ ETO-MON output

If the HWTO1 input or the HWTO2 input is turned OFF when the "Occur alarm at HWTO input OFF" parameter is set to "Disable," the ETO-MON output is turned ON. If the motor is excited after the HWTO1 input and the HWTO2 input are turned ON, the ETO-MON output is turned OFF.

Related parameter

Parameter name	Description	Initial setting	
		Initial value	Unit
Occur alarm at HWTO input OFF	Sets whether to generate an alarm of "HWTO input detection" when both the HWTO1 and HWTO2 inputs are turned OFF. [Setting range] 0: Disable 1: Enable	0	–

■ EDM-MON output

If both the HWTO1 and HWTO2 inputs are turned OFF, the EDM-MON output is turned ON.

HWTO1 input	HWTO2 input	EDM-MON output	Motor excitation
ON	ON	OFF	Excitation
ON	OFF	OFF	Non-excitation
OFF	ON	OFF	
OFF	OFF	ON	

■ HWTOIN-MON output

If either the HWTO1 input or the HWTO2 input is turned OFF, the HWTOIN-MON output is turned ON.

5-9 Motor position indication

■ ZSG-N output

This signal is turned ON every time the actual position of the motor is increased by 72 ° from the position having preset by the maintenance command "ZSG-PRESET."

Related parameter

Parameter name	Description	Initial setting	
		Initial value	Unit
ZSG-N signal width	Sets the output width of the ZSG-N output. [Setting range] 1 to 7200 (1=0.01°)	180	1=0.01°



Set the "ZSG-N signal width" parameter according to the operating velocity so that the ZSG-N output is output at least 1 ms.

■ AREA0 to AREA7 outputs

The AREA outputs are turned ON when the motor is inside the set area.
They are turned ON when the motor is inside the area even if the motor stops.

Related parameters

Parameter name	Description	Initial setting	
		Initial value	Unit
AREA0 positive direction position/offset to AREA7 positive direction position/offset	Sets the positive direction position or offset from the target position for the AREA0 to AREA7 outputs. [Setting range] −2,147,483,648 to 2,147,483,647 (User-defined position unit)	0	step
AREA0 negative direction position/detection range to AREA7 negative direction position/detection range	Sets the negative direction position or the distance (width) from the offset position for the AREA0 to AREA7 outputs. [Setting range] −2,147,483,648 to 2,147,483,647 (User-defined position unit)	0	step
AREA0 range setting mode to AREA7 range setting mode	Sets the range setting mode for the AREA0 to AREA7 outputs. [Setting range] 0: Range setting with absolute value 1: Offset/width setting from the target position	0	–
AREA0 positioning standard to AREA7 positioning standard	Sets the judgment criterion of position for the AREA0 to AREA7 outputs. [Setting range] 0: Based on actual position 1: Based on demand position	0	–

When the "AREA range setting mode" parameter is "Range setting with absolute value"

- When a value in the "AREA positive direction position/offset" parameter is larger than that in the "AREA negative direction position/detection range" parameter

When the motor position is larger than a value in the "AREA negative direction position/detection range" parameter or smaller than that in the "AREA positive direction position/offset" parameter, the AREA output is turned ON.

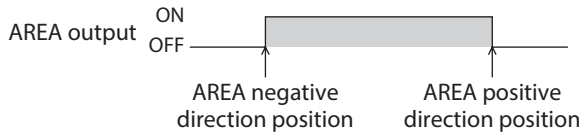

- When a value in the "AREA positive direction position/offset" parameter is smaller than that in the "AREA negative direction position/detection range" parameter

When the motor position is smaller than a value in the "AREA positive direction position/offset" parameter or larger than that in the "AREA negative direction position/detection range" parameter, the AREA output is turned ON.

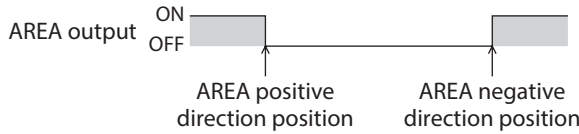

- When a value in the "AREA positive direction position/offset" parameter is equal to that in the "AREA negative direction position/detection range" parameter

When the motor position is equal to values in the "AREA positive direction position/offset" parameter and the "AREA negative direction position/detection range" parameter, the AREA output is turned ON.

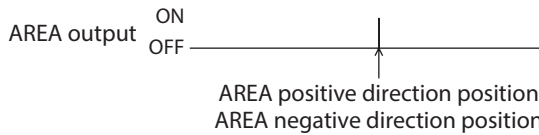

When the "AREA range setting mode" parameter is "Offset/width setting from the target position"

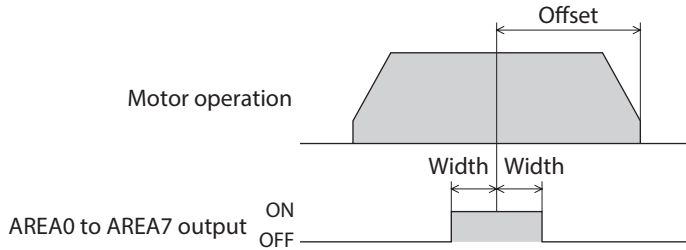

■ FW-SLS output, RV-SLS output

When the demand position is exceeded the software limit range when the software overtravel is enabled, the FW-SLS output or the RV-SLS output is turned ON.

Also, if the target position in excess of the software limit range is set, the FW-SLS output or the RV-SLS output is turned ON. And the FW-SLS output or the RV-SLS output is turned OFF when operation is started or the motor excitation is turned OFF.

memo Refer to "3-3 Software overtravel" on p.36 for details about the software overtravel.

■ WRAP-ZERO output

If the position set with the "WRAP-ZERO signal base setting" parameter is in the home position of the WRAP range when the "WRAP setting" parameter is set to "Follows WRAP setting lower limit/WRAP setting upper limit," the WRAP-ZERO output is turned ON.

Using the "The number of the WRAP-ZERO output in wrap range" parameter can output the signal for each interval by equally dividing the WRAP range by a desired number of divisions.

Related parameters

Parameter name	Description	Initial setting	
		Initial value	Unit
The number of the WRAP-ZERO output in wrap range	Sets how often the WRAP-ZERO output is turned ON within the WRAP range. [Setting range] 1 to 536,870,911 divisions	1	–
WRAP-ZERO signal width	Sets the output width of the WRAP-ZERO output. [Setting range] 1 to 10,000 (User-defined position unit)	10	step
WRAP-ZERO signal base setting	Sets the criterion of the WRAP-ZERO output. [Setting range] 0: Based on actual position 1: Based on demand position	0	–

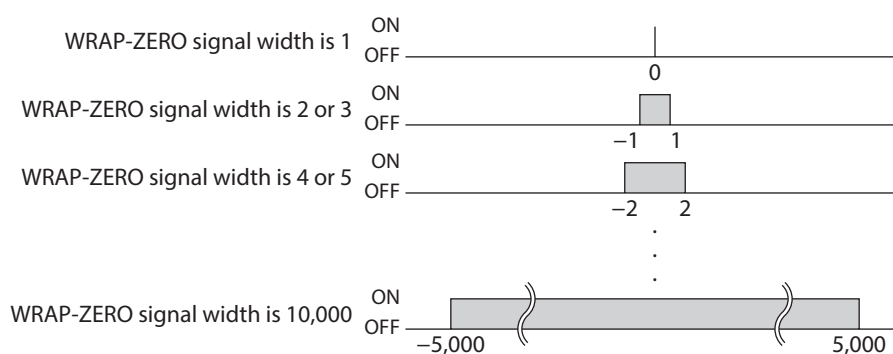

■ WRAP-OVF output

The ON/OFF of the WRAP-OVF output is inverted when the wrap range is exceeded.

5-10 Coordinate status indication

■ ABSPEN output

The ABSPEN output is turned ON when the coordinates are set.

■ ELPRST-MON output

The ELPRST-MON output is turned ON when the electrical home coordinate is enabled.

5-11 Latch information indication

■ USR-LAT0 output, USR-LAT1 output

Each output is turned ON when a trigger for the user latch input is detected.

When the LAT-CLR input is turned from OFF to ON, the output is turned OFF.

The relation between the trigger of the user latch input and the output is as follows.

- USR-LAT-IN0 input (or ZSG-N output): USR-LAT0 output
- USR-LAT-IN1 input (or ZSG-N output): USR-LAT1 output

■ JUMP0-LAT output, JUMP1-LAT output, JUMP2-LAT output

If the event trigger is detected, each output is turned ON.

When the LAT-CLR input is turned from OFF to ON, the output is turned OFF.

The relation between the event trigger and the output is as follows.

- (Low) I/O event number: JUMP0-LAT output
- (Middle) I/O event number: JUMP1-LAT output
- (High) I/O event number: JUMP2-LAT output

■ NEXT-LAT output

When the NEXT input is turned from OFF to ON, the NEXT-LAT output is turned ON. When the LAT-CLR input is turned from OFF to ON, the NEXT-LAT output is turned OFF.

■ STOP-LAT output

If the event to stop operation occurs, the STOP-LAT output is turned ON. When the LAT-CLR input is turned from OFF to ON, the STOP-LAT output is turned OFF.

Events to stop operation are as follows.

- When operation is stopped by the S-ON input, the FREE input, the CLR input, the QSTOP input, or the STOP input.
- When operation is stopped by the Quick stop event or the Halt event.
- When operation is stopped by software overtravel or hardware overtravel.
- When operation was stopped by alarm generation.
- When operation is stopped by the FW-BLK input while operation in the forward direction is executed.
- When operation is stopped by the RV-BLK input while operation in the reverse direction is executed.
- When operation is stopped by "Stop operation" of the maintenance command.
- When the power supply for communication is lost and operation is stopped.

5-12 User output signals

■ USR-OUT0 to USR-OUT7

A logical conjunction or a logical disjunction of two types of output signals and the comparison result with the internal monitor group are output. Up to 8 user outputs can be set.

The output condition for user outputs can be selected from the following two items.

● Internal IO judgment

Assign two types of signals (A and B) to a single user output. USR-OUT is output after the logical combination of A and B is established.

● Value judgment

Set the ON condition to a single user output. USR-OUT is output after the ON condition is established.

Related parameters

Parameter name	Description	Initial setting	
		Initial value	Unit
User output operation mode	Selects the operation mode of the user output. [Setting range] 0: Internal IO judgment 1: Value judgment (value X, value Y) = (value A, value B) 2: Value judgment (value X, value Y) = (value of NET-ID=A, value B) 3: Value judgment (value X, value Y) = (value A, value of NET-ID=B) 4: Value Judgment (value X, value Y) = (value of NET-ID=A, value of NET-ID=B)	0	–
User output (IO) source A function	Selects the user output source A function (output signal) for USR-OUT0 to USR-OUT7. [Setting range] ⇒ "2-2 Output signals list" on p.154	128: CONST-OFF	–
User output (IO) source A inverting mode	Changes ON/OFF of the user output source A. [Setting range] 0: Not invert 1: Invert	0	–
User output (IO) source B function	Selects the user output source B function (output signal) for USR-OUT0 to USR-OUT7. [Setting range] ⇒ "2-2 Output signals list" on p.154	128: CONST-OFF	–
User output (IO) source B inverting mode	Changes ON/OFF of the user output source B. [Setting range] 0: Not invert 1: Invert	0	–
User output (IO) logical operation	Sets the logical combination of user output source A and user output source B. [Setting range] 0: AND 1: OR	1	–

Parameter name	Description	Initial setting	
		Initial value	Unit
User output (value) ON condition	Select the ON condition of the user output when the value judgment is selected for the operation mode. [Setting range] 0: (value of target NET-ID + value Y) = (value X) 1: (value of target NET-ID + value Y) < (value X) 2: (value of target NET-ID + value Y) ≤ (value X) 3: (value X) < (value of target NET-ID + value Y) 4: (value X) ≤ (value of target NET-ID + value Y) 5: (value of target NET-ID) < (value X) or (value Y) < (value of target NET-ID) 6: (value of target NET-ID) ≤ (value X) or (value Y) ≤ (value of target NET-ID) 7: (value X) < (value of target NET-ID) < (value Y) 8: (value X) ≤ (value of target NET-ID) ≤ (value Y) 9: (value Y) = ((value of target NET-ID) And (value X)) 10: (value Y) = ((value of target NET-ID) Or (value X)) 11: ((value of target NET-ID) And (value X)) is not 0	0	–
User output (value) target NET-ID	Sets the target NET-ID of the user output. [Setting range] 0 to 65,535	0	–
User output (value) value A	Sets the value A of the user output. [Setting range] –2,147,483,648 to 2,147,483,647	0	–
User output (value) value B	Sets the value B of the user output. [Setting range] –2,147,483,648 to 2,147,483,647	0	–



Refer to p.472 for details about user output.

5-13 Response output

The response output is a signal to output the ON-OFF status of the corresponding input signal. The table below shows the correspondences between input signals and output signals.

Input signal	Output signal	Input signal	Output signal	Input signal	Output signal
FREE	FREE_R	FW-JOG-P	FW-JOG-P_R	D-SEL14	D-SEL14_R
S-ON	S-ON_R	RV-JOG-P	RV-JOG-P_R	D-SEL15	D-SEL15_R
CLR	CLR_R	FW-POS	FW-POS_R	R0	R0_R
QSTOP	QSTOP_R	RV-POS	RV-POS_R	R1	R1_R
STOP	STOP_R	FW-SPD	FW-SPD_R	R2	R2_R
BREAK-ATSQ	BREAK-ATSQ_R	RV-SPD	RV-SPD_R	R3	R3_R
ALM-RST	ALM-RST_R	FW-PSH	FW-PSH_R	R4	R4_R
P-PRESET	P-PRESET_R	RV-PSH	RV-PSH_R	R5	R5_R
EL-PRST	EL-PRST_R	USR-LAT-IN0	USR-LAT-IN0_R	R6	R6_R
USR-ALM	USR-ALM_R	USR-LAT-IN1	USR-LAT-IN1_R	R7	R7_R
ETO-CLR	ETO-CLR_R	FW-BLK	FW-BLK_R	R8	R8_R
LAT-CLR	LAT-CLR_R	RV-BLK	RV-BLK_R	R9	R9_R
INFO-CLR	INFO-CLR_R	FW-LS	FW-LS_R	R10	R10_R
HMI	HMI_R	RV-LS	RV-LS_R	R11	R11_R
TRQ-LMT	TRQ-LMT_R	HOMES	HOMES_R	R12	R12_R
SPD-LMT	SPD-LMT_R	SLIT	SLIT_R	R13	R13_R
PLOOP-MODE	PLOOP-MODE_R	ID-SEL0	ID-SEL0_R	R14	R14_R
ATL-EN	ATL-EN_R	ID-SEL1	ID-SEL1_R	R15	R15_R
START	START_R	ID-SEL2	ID-SEL2_R	R16	R16_R
SSTART	SSTART_R	ID-SEL3	ID-SEL3_R	R17	R17_R
NEXT	NEXT_R	D-SEL0	D-SEL0_R	R18	R18_R
HOME	HOME_R	D-SEL1	D-SEL1_R	R19	R19_R
M0	M0_R	D-SEL2	D-SEL2_R	R20	R20_R
M1	M1_R	D-SEL3	D-SEL3_R	R21	R21_R
M2	M2_R	D-SEL4	D-SEL4_R	R22	R22_R
M3	M3_R	D-SEL5	D-SEL5_R	R23	R23_R
M4	M4_R	D-SEL6	D-SEL6_R	R24	R24_R
M5	M5_R	D-SEL7	D-SEL7_R	R25	R25_R
M6	M6_R	D-SEL8	D-SEL8_R	R26	R26_R
M7	M7_R	D-SEL9	D-SEL9_R	R27	R27_R
FW-JOG	FW-JOG_R	D-SEL10	D-SEL10_R	R28	R28_R
RV-JOG	RV-JOG_R	D-SEL11	D-SEL11_R	R29	R29_R
FW-JOG-H	FW-JOG-H_R	D-SEL12	D-SEL12_R	R30	R30_R
RV-JOG-H	RV-JOG-H_R	D-SEL13	D-SEL13_R	R31	R31_R

6 Using general signals

The R0 to R31 inputs are general signals. Using the R0 to R31 inputs, I/O signals of the external equipment can be controlled by the host controller via the driver. Direct I/O of the driver can be used as an I/O module.

■ Example of use for general signals

● When signals are output from the host controller to the external equipment

Assign the R0 input to R-IN0 and the R0_R output to DOUT0.

The DOUT0 output is turned ON when R-IN0 is set to 1, and the DOUT0 output is turned OFF when R-IN0 is set to 0.

● When outputs of the external equipment are input to the host controller

Assign the R1 input to DIN1 and the R1_R output to R-OUT1.

The R-OUT1 output is set to 1 when the DIN1 input is turned ON by the external equipment, and the R-OUT1 output is set to 0 when the DIN1 input is turned OFF. ON/OFF of the DIN1 input can be set using the "DIN1 inverting mode" parameter.

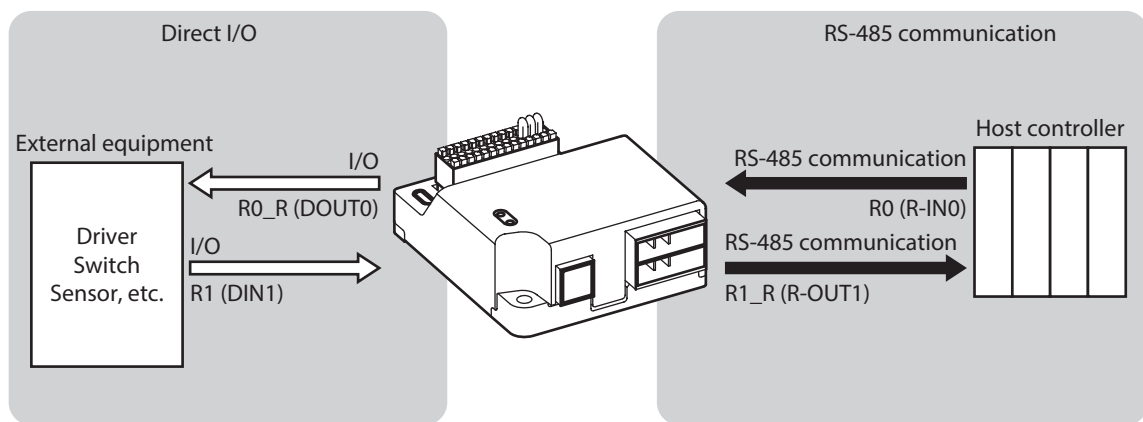

Related parameters

	Parameter name	Description	Initial value
Direct-IN	Input function	Selects the input signal to be assigned to direct I/O. [Setting range] Input signal list ⇨ "2-1 Input signals list" on p.151	Varies depending on input
	Inverting mode	[Setting Range] 0: ON/OFF of the input signal is not inverted 1: ON/OFF of the input signal is inverted	0
Direct-OUT	Output function	Selects the output signal to be assigned to direct I/O. [Setting range] Output signal list ⇨ "2-2 Output signals list" on p.154	Varies depending on output
	Inverting mode	[Setting Range] 0: ON/OFF of the output signal is not inverted 1: ON/OFF of the output signal is inverted	0
Remote-I/O	Input function	Selects the input signal to be assigned to remote-I/O. [Setting range] Input signal list ⇨ "2-1 Input signals list" on p.151	Varies depending on input
	Output function	Selects the output signal to be assigned to remote-I/O. [Setting range] Output signal list ⇨ "2-2 Output signals list" on p.154	Varies depending on output

7 Timing chart

■ Power activation

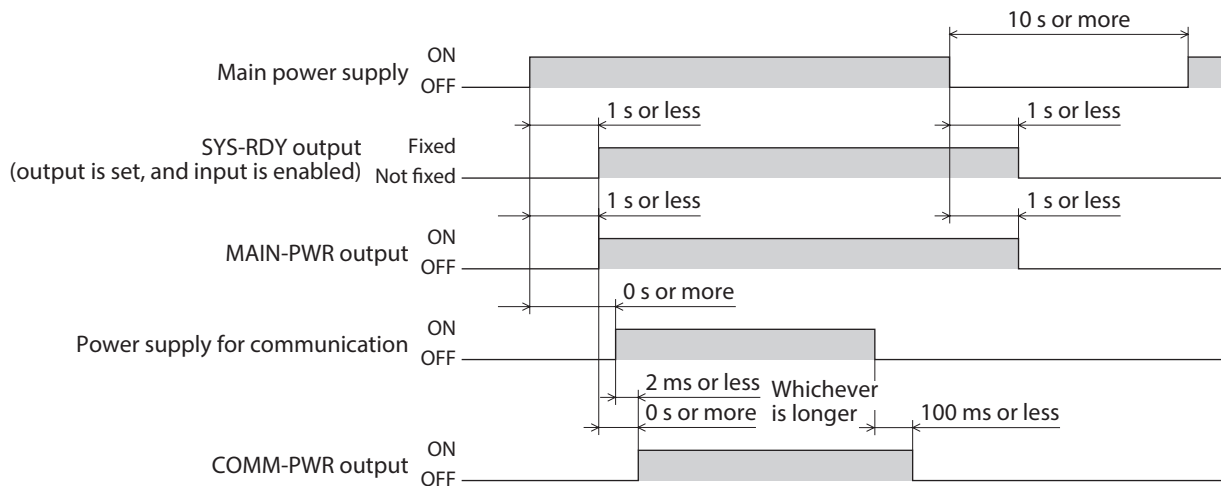

3 I/O signals

■ Excitation

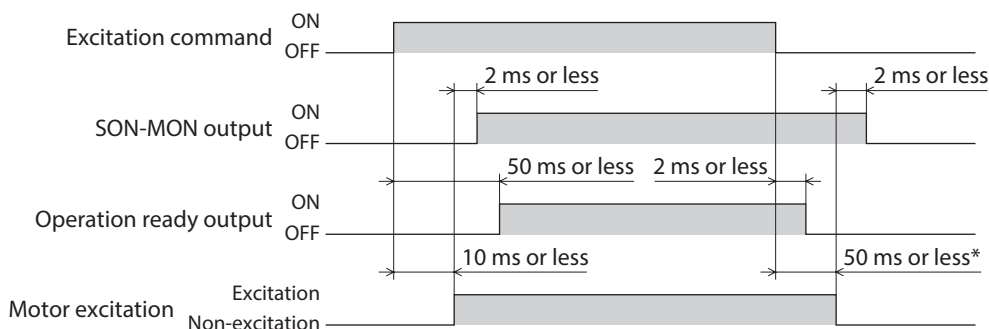

* The time period varies depending on a load or an operating condition while the motor rotates.

■ Electromagnetic brake

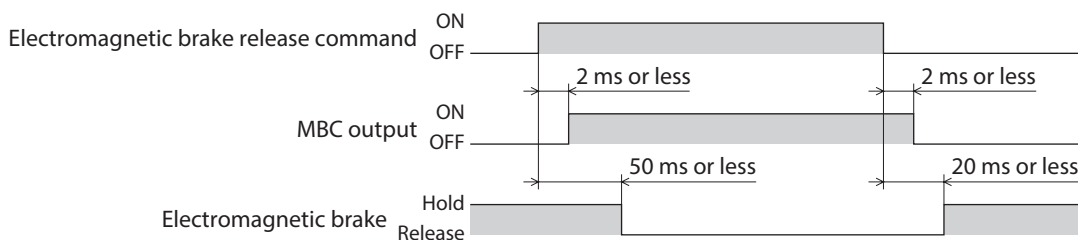

■ I/O signals

(when the output is switched according to the ON edge of the input signal)

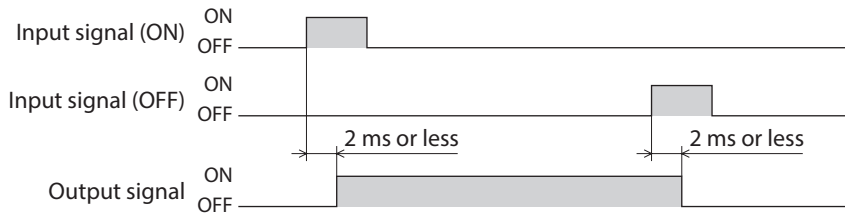

■ I/O signals (when the output is switched with the ON/OFF edge of the input signal)

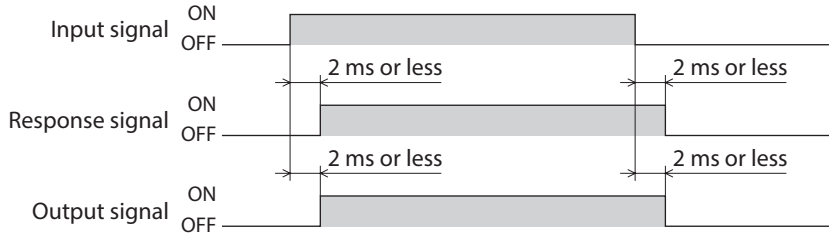

4 Power removal function

This part explains the power removal function.

◆ Table of contents

1	Overview of power removal function	208
1-1	Block diagram.....	208
2	Safety precautions for the power removal function.....	209
3	Connecting I/O signals for power removal function.....	210
3-1	Input signals.....	210
3-2	Output signal.....	211
4	How to use power removal function	212
4-1	Transition to power removal status.....	212
4-2	Return from power removal status.....	213
4-3	Failure detection of power removal function....	214
5	Related functions	215
5-1	Input signal	215
5-2	Output signals.....	215
5-3	Alarms	216
5-4	Parameters.....	216

1 Overview of power removal function

This driver is equipped with the power removal function that shuts off the power supply to the motor by the hardware.

The drive signal of the inverter circuit to control the motor current is shut off by the duplexing circuit that the HWTO1 input and the HWTO2 input are connected separately. This brings a state in which the current to the motor is shut off (power removal status).

1-1 Block diagram

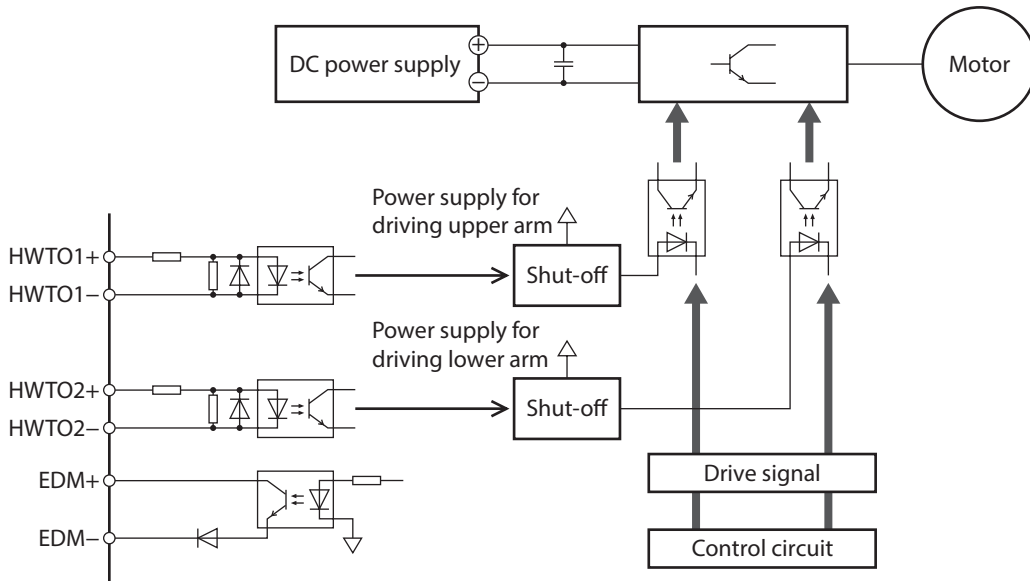

2 Safety precautions for the power removal function

- If the power removal function is activated, the motor holding force is lost and the motor output shaft may be rotated by external forces (gravity on a vertical axis, etc.). If the motor output shaft is required to hold in position, install an external brake mechanism or equivalent. Failure to do so may result in injury or damage to equipment.
- The power removal function is a function to shut off the power supply to the motor by stopping operation of the inverter circuit. It is not a function to physically shut off the driver and the motor. When touching the driver or the motor, turn off the driver power and check the PWR/SYS LED is turned off. Failure to do so may result in electric shock.
- Be sure to check the motor is in a standstill state before transitioning to the power removal status. Transitioning to the power removal status while the motor is rotating may cause damage to the motor, driver, or equipment.

3 Connecting I/O signals for power removal function

When connecting the signals for power removal function, be sure to remove the jumper wires (included) that connects +V and HWTO1+, HWTO1- and HWTO2+, and HWTO2- and 0V. Do not connect anything to +V and 0V.

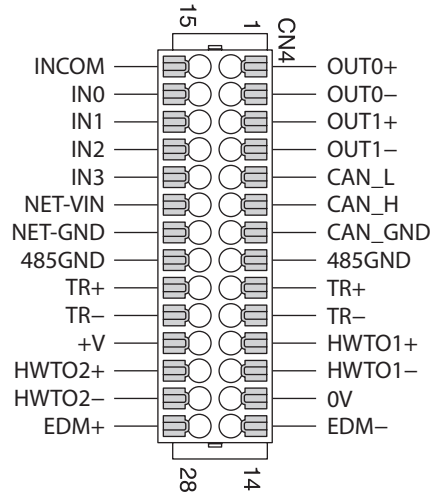

4 Power removal function

3-1 Input signals

HWTO1 input, HWTO2 input

These are signals to activate the power removal function. Turning the HWTO1 input OFF causes the upper arm drive signal of the inverter circuit to shut off. Turning the HWTO2 input OFF causes the lower arm drive signal of the inverter circuit to shut off.

Signal name	Specifications
HWTO1+ input HWTO1- input	12 to 30 VDC
HWTO2+ input HWTO2- input	

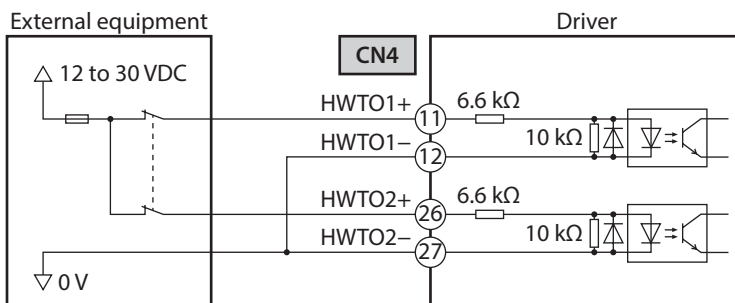

Note Provide the contacts individually for operating the HWTO1 input and the HWTO2 input.

3-2 Output signal

■ EDM output

The EDM output is a signal to monitor a failure in the power removal function.

Signal name	Specifications
EDM+ output	12 to 30 VDC, 10 mA or less
EDM- output	Output saturated voltage 2.0 V maximum

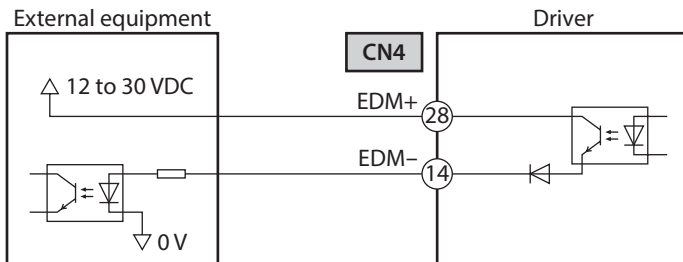

Note The EDM output is not an output signal to ensure the safety. Do not use the EDM output for any other purpose except for monitoring a failure.

4 How to use power removal function

4-1 Transition to power removal status

1. Turn both the HWT01 and HWT02 inputs OFF.

Note Be sure to check the motor is in a standstill state before transitioning to the power removal status. Transitioning to the power removal status while the motor is rotating may cause damage to the motor, driver, or equipment.

2. The driver transitions to the power removal status to shut off the power supply to the motor, and the motor puts into a non-excitation state.

Note When the OFF time of the HWT01 input and HWT02 input is less than 15 ms, the driver may not transition to the power removal status.

3. If the "Occur alarm at HWT0 input OFF" parameter is set to "Disable" (initial value: Disable), the ETO-MON output is turned ON and the PWR/SYS LED blinks in white when the HWT01 input or the HWT02 input is turned OFF. Also, the operation ready output is turned OFF. When an electromagnetic brake motor is used, the electromagnetic brake actuates to hold the motor shaft.

■ Timing chart

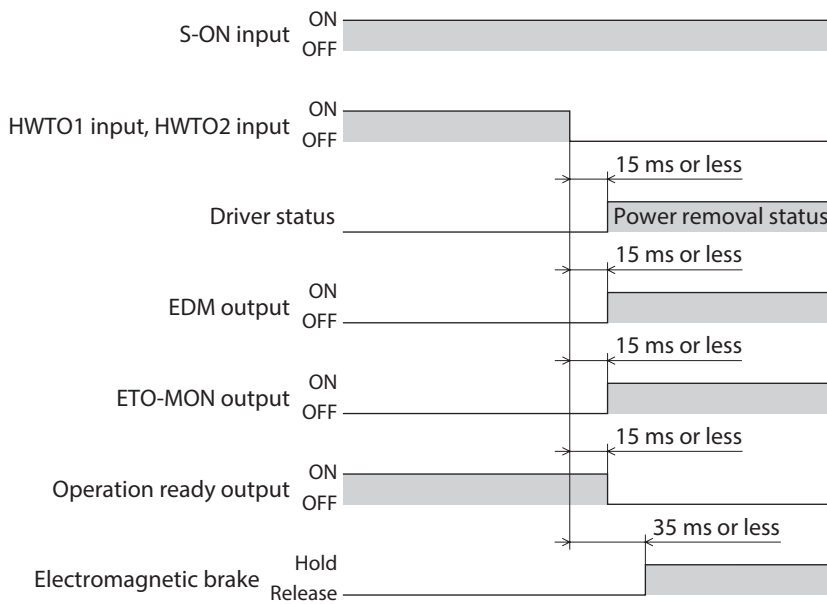

4-2 Return from power removal status

1. Turn both the HWTO1 and HWTO2 inputs ON.



- Check the equipment is in a safe state before returning the driver from the power removal status.
- The power removal status cannot be released even if only one of the HWTO1 input and the HWTO2 input is turned ON.

2. The power removal status is released.



- When the power removal status is released, shutting off the power supply to the motor by the hardware is released.
- The motor remains in a non-excitation state.
- When the ON time of the HWTO1 input and HWTO2 input is less than 15 ms, the power removal status may not be released.

3. When the ETO-CLR input is turned ON (the initial value: enabled at the ON edge), the ETO status is released, the ETO-MON output is turned OFF, the PWR/SYS LED is lit in white, and the motor is excited. Also, the operation ready output is turned ON.

When an electromagnetic brake motor is used, the electromagnetic brake is released.



Refer to "6 Driver status and motor excitation" on p.42 for the ETO Status.

■ Timing chart

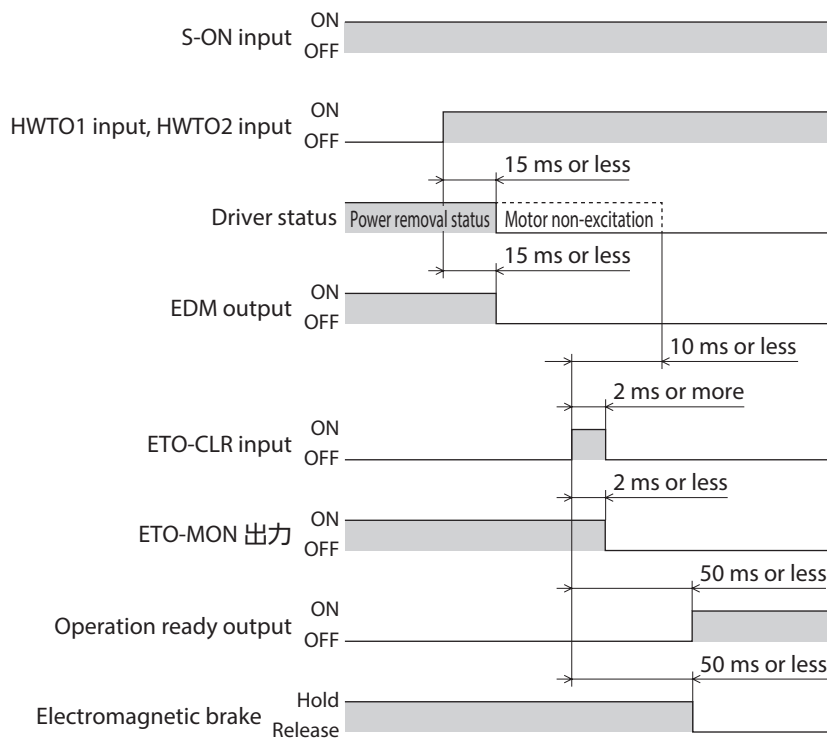

4-3 Failure detection of power removal function

A failure of the power removal function can be detected by monitoring the EDM output for the status of the HWTO1 and HWTO2 inputs.

To transition to the power removal status, turn both the HWTO1 and HWTO2 inputs OFF.

To release the power removal status, turn both the HWTO1 and HWTO2 inputs ON.

When the EDM output is in an OFF state, do not release the power removal status.

A combination of the HWTO1 input, HWTO2 input, and EDM output is any of the following.

HWTO1 input	HWTO2 input	EDM output	Motor excitation
ON	ON	OFF	Excitation
OFF	OFF	ON	Non-excitation
ON	OFF	OFF	Non-excitation
OFF	ON	OFF	Non-excitation

For combinations other than the above table, the power removal function of the driver is in a failure state.

However, if one of the duplexing wirings failed, the driver cannot determine whether a failure is caused by external equipment damage or wiring problem. At this time, both the HWTO1 and HWTO2 inputs are turned ON or OFF, the EDM output is turned OFF, and the motor puts into a non-excitation state.



If a failure in the driver or external equipment or an error in wirings occurred, check the cause and take measures immediately.

5 Related functions

5-1 Input signal

■ ETO-CLR input

After both the HWTO1 and HWTO2 inputs are turned ON and the power removal status is released, if the ETO-CLR input is turned ON, the motor puts into an excitation state. (When the S-ON input is ON)

Related parameter

Parameter name	Description	Initial setting	
		Initial value	Unit
ETO reset action (ETO-CLR)	Sets the judgment criterion of the signal when the ETO status is released by the ETO-CLR input. [Setting range] 1: ON edge (Positive edge) 2: ON level	1	–

5-2 Output signals

■ ETO-MON output

If the "Occur alarm at HWTO input OFF" parameter is set to "Disable," the ETO-MON output is turned ON when the HWTO1 input or the HWTO2 input is turned OFF. If the ETO-CLR input is turned ON after both the HWTO1 and HWTO2 inputs are turned ON, the ETO-MON output is turned OFF.

Related parameter

Parameter name	Description	Initial setting	
		Initial value	Unit
Occur alarm at HWTO input OFF	Sets whether to generate an alarm of "HWTO input detection" when both the HWTO1 and HWTO2 inputs are turned OFF. [Setting range] 0: Disable 1: Enable	0	–

■ EDM-MON output

A combination of the HWTO1 input, HWTO2 input, and EDM-MON output is any of the following.

HWTO1 input	HWTO2 input	EDM-MON output
ON	ON	OFF
OFF	OFF	ON
ON	OFF	OFF
OFF	ON	OFF



Use the EDM output when monitoring a failure of the power removal function.

■ **HWTOIN-MON output**

If the HWTO1 input or the HWTO2 input is turned OFF, the HWTOIN-MON output is turned ON.

HWTO1 input	HWTO2 input	HWTOIN-MON output
ON	ON	OFF
OFF	OFF	ON
ON	OFF	ON
OFF	ON	ON

5-3 Alarms

■ **Alarm of HWTO input detection**

If the "Occur alarm at HWTO input OFF" parameter is set to "Enable," an alarm of HWTO input detection is generated when the HWTO1 input and the HWTO2 input are turned OFF. At this time, the PWR/SYS LED blinks in red. The ETO-MON output remains OFF.

■ **Alarm of HWTO input circuit error**

If a time from when either the HWTO1 input or the HWTO2 input is turned OFF until the other input is turned OFF exceeds the value set in the "HWTO delay time of checking dual system" parameter, an alarm of HWTO input circuit error is generated. At this time, the PWR/SYS LED blinks in red.

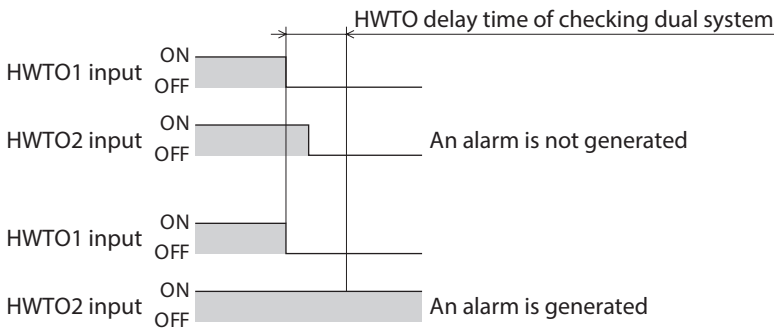

5-4 Parameters

Parameters related to the power removal function are as follows.

Parameter name	Description	Initial setting	
		Initial value	Unit
Occur alarm at HWTO input OFF	Sets whether to generate an alarm of "HWTO input detection" when both the HWTO1 and HWTO2 inputs are turned OFF. [Setting range] 0: Disable 1: Enable	0	–
HWTO delay time of checking dual system	Sets a threshold from when either the HWTO1 input or the HWTO2 input is turned OFF until the other input is turned OFF. If the other input is not turned OFF even when the threshold is exceeded, an alarm is generated. [Setting range] 0 to 10: Disable 11 to 100 ms	0	–

5 Modbus RTU control (RS-485 communication)

This part describes how to control from the host controller via RS-485 communication. The protocol used in RS-485 communication is the Modbus protocol.

◆Table of contents

1	Modbus RTU specifications	218	9	RS-485 communication monitor	258
1-1	Communications specifications	219	10	Timing chart	259
1-2	Communication timing	222	10-1	Communication start.....	259
2	Message structure	224	10-2	Operation start.....	259
2-1	Query.....	224	10-3	Operation stop, velocity change	259
2-2	Response.....	226	10-4	General signal.....	260
3	Function code	228	10-5	Configuration	260
3-1	Reading from a holding register(s) (03h).....	228	11	Detection of communication errors	261
3-2	Writing to a holding register (06h)	229	11-1	Communication errors	261
3-3	Diagnosis (08h)	230	11-2	Alarms related to RS-485 communication	261
3-4	Writing to multiple holding registers (10h).....	230	11-3	Information related to RS-485 communication	262
3-5	Read/write of multiple holding registers (17h).....	232	12	Modbus RTU ID share mode	263
4	Flow of settings necessary for Modbus communication	234	12-1	Overview of Modbus RTU ID share mode.....	263
5	Setting of RS-485 communication	235	12-2	Function code	264
5-1	Parameters updated when turning on the main power supply.....	235	12-3	Guidance	265
5-2	Parameters updated immediately after overriding	236	12-4	Flow of setting of ID share mode	270
6	Setting example of data in Modbus RTU mode	237	12-5	Initial setting of ID share mode.....	271
6-1	Remote I/O commands.....	237	12-6	Setting of data to be read or written	272
7	Data setting method	240	12-7	Read/write in ID share mode	275
7-1	Overview of setting methods.....	240	12-8	Parameter list for Modbus RTU ID share mode	283
7-2	Direct reference	241			
7-3	Indirect reference.....	242			
8	Group send	256			

1 Modbus RTU specifications

The Modbus protocol is simple to use and its specification is open to the public, so this protocol is widely used in industrial applications.

Modbus communication is based on the single-master/multiple-slave method. Only the master can issue a query (command).

Each slave executes the process requested by query and returns a response message.

The driver supports the RTU mode only as the transmission mode. The ASC II mode is not supported.

Under this protocol, messages are sent in one of three methods.

- **Unicast mode**

The master sends a query to only one slave. The slave executes the process and returns a response.

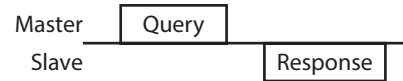

- **Broadcast mode**

If the slave address 0 is specified on the master, the master can send a command to all slaves. Each slave executes the process, but does not return a response.

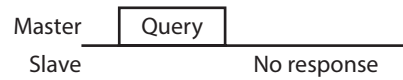

- **ID share mode**

The master can send a query to multiple slaves at once by sharing a slave address (share ID) with multiple slaves. The slave executes the process and returns a response sequentially. In the ID share mode, synchronization between slaves is better than in the unicast mode since a query can be sent to multiple slaves at the same time. The ID share mode is our unique transmission method.

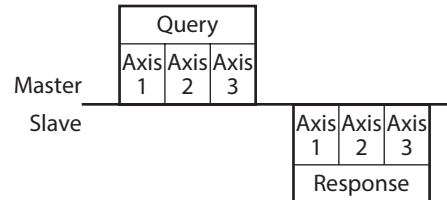

1-1 Communications specifications

Electrical characteristics	In conformance with EIA-485 Use twisted-pair wires and keep the total extension distance up to 10 m (32.8 ft.). *
Communication mode	Half duplex Asynchronous mode (data: 8 bits, stop bit: 1 bit/2 bits, parity: none/even number/odd number)
Transmission rate	Selectable from 9,600 bps, 19,200 bps, 38,400 bps, 57,600 bps, 115,200 bps, and 230,400 bps.
Protocol	Modbus RTU mode
Type of Connection	Up to 31 drivers can be connected to one host controller.

* If the motor cable or power supply cable generates an undesirable amount of noise depending on the wiring or configuration, shield the cable or install a ferrite core.

■ Connection example

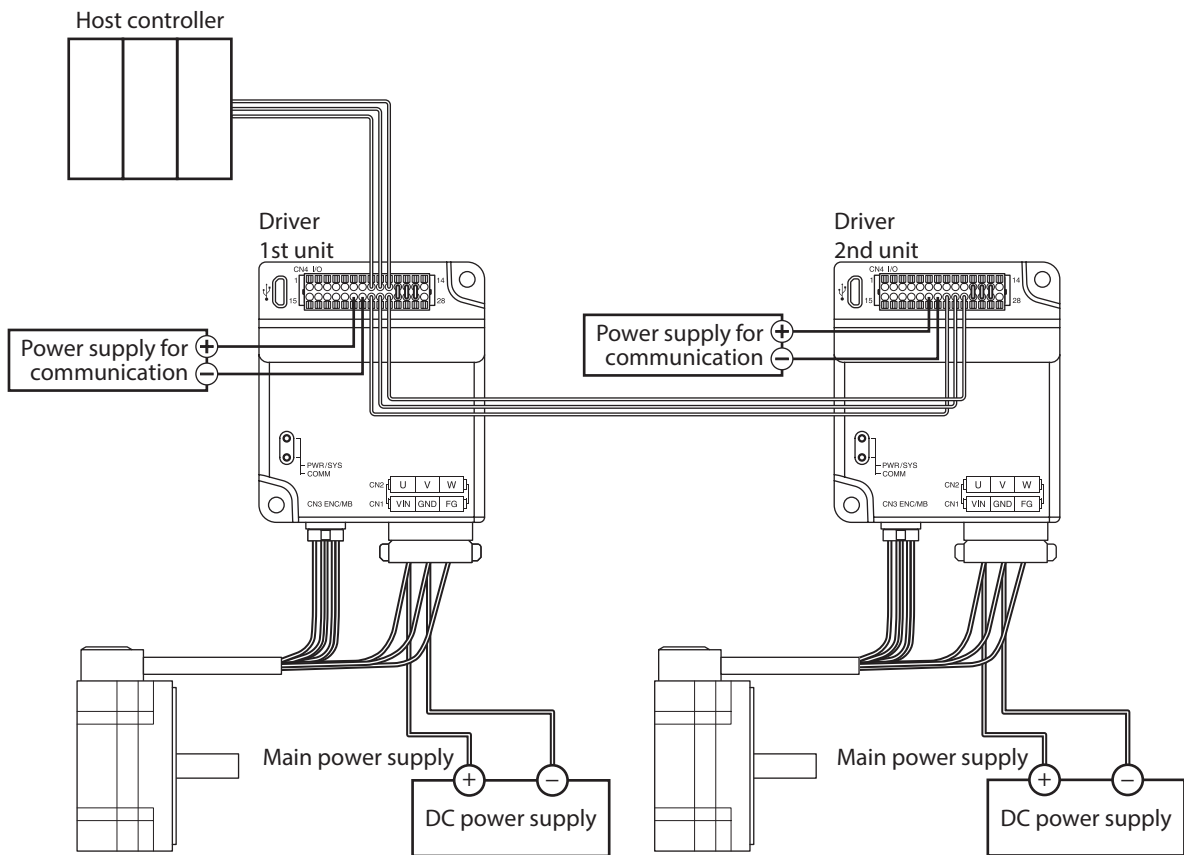

■ Termination resistor

Connect a termination resistor for a driver located the farthest away (positioned at the end) from the host controller. There are the following two methods for how to connect a termination resistor.

● When a termination resistor inside the driver is used

Using the support software, set the "RS-485 communication termination resistor" parameter to "Enable" or to the terminating slave address.

Name	Setting
RS-485 communication termination resistor	Enable

Note The termination resistor is turned ON only when the main power is supplied to the driver since it is turned ON or OFF inside the driver.

memo The termination resistor inside the driver is enabled when the slave address 4 is set (initial value). When the slave address 4 is used, check the connection of a termination resistor.

● When a resistor (120 Ω) is connected between the TR+ and TR– terminals of the CN4 connector

Connecting method

1. Connect lead wires to a resistor.
2. Connect the lead wires between the TR+ and TR– terminals of CN4.

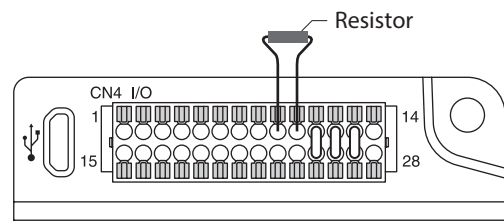

Note

- Be sure to connect a resistor between the TR+ and TR– terminals. Incorrect connection may cause damage to the resistor.
- When connecting a resistor, set the "RS-485 communication termination resistor" parameter to "Disable."

memo For a resistor, use a metal film resistor of 120 Ω, 1/2 W or more.

Related parameter

Register address		Parameter name	Description	Initial setting	
Upper	Lower			Initial value	Unit
990 (03DEh)	991 (03DFh)	RS-485 communication termination resistor	Selects the setting of the termination resistor for RS-485 communication built in the driver. [Setting Range] -1: Enable 0: Disable 1: Follow communication ID (Enable when the active communication ID is 1) 2: Follow communication ID (Enable when the active communication ID is 2) 3: Follow communication ID (Enable when the active communication ID is 3) 4: Follow communication ID (Enable when the active communication ID is 4) 5: Follow communication ID (Enable when the active communication ID is 5) 6: Follow communication ID (Enable when the active communication ID is 6) 7: Follow communication ID (Enable when the active communication ID is 7) 8: Follow communication ID (Enable when the active communication ID is 8) 9: Follow communication ID (Enable when the active communication ID is 9) 10: Follow communication ID (Enable when the active communication ID is 10) 11: Follow communication ID (Enable when the active communication ID is 11) 12: Follow communication ID (Enable when the active communication ID is 12) 13: Follow communication ID (Enable when the active communication ID is 13) 14: Follow communication ID (Enable when the active communication ID is 14) 15: Follow communication ID (Enable when the active communication ID is 15) 16: Follow communication ID (Enable when the active communication ID is 16) 17: Follow communication ID (Enable when the active communication ID is 17) 18: Follow communication ID (Enable when the active communication ID is 18) 19: Follow communication ID (Enable when the active communication ID is 19) 20: Follow communication ID (Enable when the active communication ID is 20) 21: Follow communication ID (Enable when the active communication ID is 21) 22: Follow communication ID (Enable when the active communication ID is 22) 23: Follow communication ID (Enable when the active communication ID is 23) 24: Follow communication ID (Enable when the active communication ID is 24) 25: Follow communication ID (Enable when the active communication ID is 25) 26: Follow communication ID (Enable when the active communication ID is 26) 27: Follow communication ID (Enable when the active communication ID is 27) 28: Follow communication ID (Enable when the active communication ID is 28) 29: Follow communication ID (Enable when the active communication ID is 29) 30: Follow communication ID (Enable when the active communication ID is 30) 31: Follow communication ID (Enable when the active communication ID is 31)	4	-

■ Address number setting (communication ID)

Set the address number (communication ID) of RS-485 communication. There are the following two methods for how to set the address number.

● When setting using the support software.

Set the address number with "Starts the simple setting." of the support software.

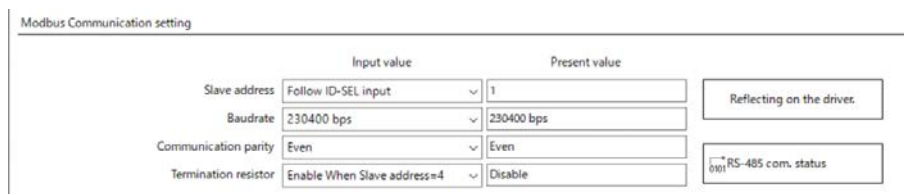

● When setting using the ID-SEL0 to ID-SEL3 input signals.

Set the address number based on a combination of ON-OFF status of the ID-SEL0 to ID-SEL3 input signals. Refer to p.185 for ID-SEL input signals.

1-2 Communication timing

The communication time monitored by the driver and the communication timing of the master are as follows.

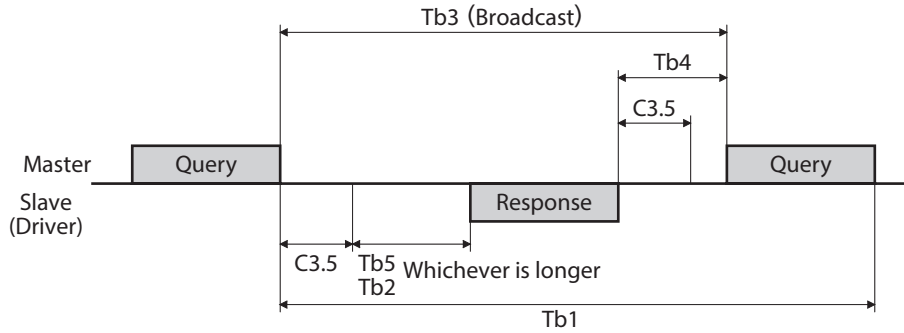

Code	Name	Description
Tb1	Communication timeout (driver)	The driver monitors an interval between received queries. If the driver cannot receive a query after the time set in the "Communication timeout (Modbus)" parameter (Initial value: Disable) has elapsed, an alarm of "Communication timeout" is generated. When normal messages including messages to other slaves were received, an alarm of "Communication timeout" is not generated.
Tb2	Transmission waiting time (driver)	This is the amount of time from when the driver receives a query from the master until when it starts sending a response. Set using the "Transmission waiting time (Modbus)" parameter.
Tb3	Broadcasting interval (master)	This is the amount of time until the master sends the next query in broadcasting. A time equivalent to or longer than the silent interval (C3.5) plus 5 ms is required.
Tb4	Transmission waiting time (master)	This is the amount of time from when the master receives the response until when it sends the next query (setting in the master side). Set so that it is equal to or longer than the time of the silent interval (C3.5). If the "Silent Interval (Modbus)" parameter is set to "0: Automatic," set the master side according to the "Estimate of transmission waiting time (master) (Tb4)" in the table below.
Tb5	Query processing time (driver)	This is the amount of time that the driver processes a received query. The query processing time varies depending on the message structure of the received query.
C3.5	Silent interval	This is the amount of time to determine the end of a query or response message. An interval equal to or longer than the time of the silent interval (C3.5) is required when the message ends. When the "Silent interval (Modbus)" parameter of the driver is set to "0: Automatic," the silent interval (C3.5) varies depending on the transmission rate. For details, refer to the "Silent interval (C3.5)" shown on the table below.

memo To communicate with the driver periodically, set the "Communication timeout (Modbus)" parameter. Setting the parameter can make an alarm of "RS-485 communication timeout" generate if communication between the master and the driver is disconnected.

■ When the "Silent interval (Modbus)" parameter is set to "Automatic"

Transmission rate (bps)	Silent interval (C3.5)	Estimate of transmission waiting time (Master) (Tb4)
9,600	4.0 ms or more	5.0 ms or more
19,200 or more	2.5 ms or more	3.0 ms or more

Note

- If the transmission waiting time (Tb4) of the master is shorter than the silent interval, the slave discards the message and a communication error occurs. When a communication error occurs, check the silent interval of the slave and set the transmission waiting time (Tb4) of the master again.
- The silent interval (C3.5) may vary depending on the product series connected. When connecting multiple product series, set the driver parameters as follows.
 - "Silent interval (Modbus)" parameter: "0: Automatic"
 - "Transmission waiting time (Modbus)" parameter: 1.0 ms or more
- In a system where only products having the "Silent interval (Modbus)" parameter are connected, the communication cycle can be improved if the setting of the "Silent interval (Modbus)" parameter is common to the products connected. Use in a state of setting to "0: Automatic" normally.

2 Message structure

The message format is shown below.

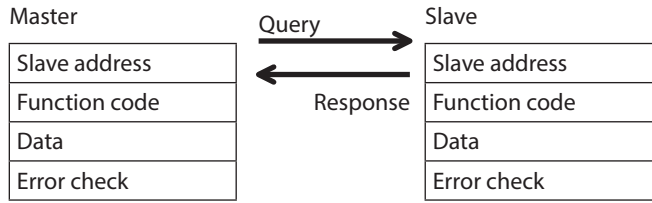

2-1 Query

The query message structure is shown below.

Slave address	Function code	Data	Error check
8 bits	8 bits	Nx8 bits	16 bits

■ Slave address

Specify the slave address. (Unicast mode)

If the slave address is set to "0," the master can send a query to all slaves. (Broadcast mode)

■ Function code

The function codes and message lengths supported by the driver are as follows.

Function code	Function	Number of registers	Broadcast
03h	Reading from holding registers	1 to 125	Not possible
06h	Writing to a holding register	1	Possible
08h	Diagnosis	–	Not possible
10h	Writing to multiple holding registers	1 to 123	Possible
17h	Read/write of multiple holding registers	Read: 1 to 125 Write: 1 to 121	Not possible

■ Data

Set data related to the function code. The data length varies depending on the function code.

■ Error check

In the Modbus RTU mode, error checks are based on the CRC-16 method. The slave calculates a CRC-16 of each received message and compares the result against the error check value included in the message. If the calculated CRC-16 value matches the error check value, the slave determines that the message is normal.

● CRC-16 calculation method

1. Calculate an exclusive-OR (XOR) value of the default value of FFFFh and slave address (8 bits).
2. Shift the result of step 1 to the right by 1 bit. Repeat this shift until the overflow bit becomes "1."
3. Upon obtaining "1" as the overflow bit, calculate an XOR of the result of step 2 and A001h.
4. Repeat steps 2 and 3 until a shift is performed eight times.
5. Calculate an XOR of the result of step 4 and function code (8 bits).
Repeat steps 2 to 4 for all bytes.
The final result gives the result of CRC-16 calculation.

● Calculation example of CRC-16

The table shows a calculation example when setting the slave address of the first byte to 02h and the function code of the second byte to 07h.

The result of actual CRC-16 calculation is calculated including the data on and after the third byte.

Description	Result	Bit shifted out
CRC register initial value FFFFh	1111 1111 1111 1111	–
Lead byte 02h	0000 0000 0000 0010	–
Initial value FFFFh and XOR	1111 1111 1111 1101	–
First time of right shift	0111 1111 1111 1110	1
A001h and XOR	1010 0000 0000 0001 1101 1111 1111 1111	–
Second time of right shift	0110 1111 1111 1111	1
A001h and XOR	1010 0000 0000 0001 1100 1111 1111 1110	–
Third time of right shift	0110 0111 1111 1111	0
Fourth time of right shift	0011 0011 1111 1111	1
A001h and XOR	1010 0000 0000 0001 1001 0011 1111 1110	–
Fifth time of right shift	0100 1001 1111 1111	0
Sixth time of right shift	0010 0100 1111 1111	1
A001h and XOR	1010 0000 0000 0001 1000 0100 1111 1110	–
Seventh time of right shift	0100 0010 0111 1111	0
Eighth time of right shift	0010 0001 0011 1111	1
A001h and XOR	1010 0000 0000 0001 1000 0001 0011 1110	–
Next byte 07h and XOR	0000 0000 0000 0111 1000 0001 0011 1001	–
First time of right shift	0100 0000 1001 1100	1
A001h and XOR	1010 0000 0000 0001 1110 0000 1001 1101	–
Second time of right shift	0111 0000 0100 1110	1
A001h and XOR	1010 0000 0000 0001 1101 0000 0100 1111	–
Third time of right shift	0110 1000 0010 0111	1
A001h and XOR	1010 0000 0000 0001 1100 1000 0010 0110	–
Fourth time of right shift	0110 0100 0001 0011	0
Fifth time of right shift	0011 0010 0000 1001	1
A001h and XOR	1010 0000 0000 0001 1001 0010 0000 1000	–
Sixth time of right shift	0100 1001 0000 0100	0
Seventh time of right shift	0010 0100 1000 0010	0
Eighth time of right shift	0001 0010 0100 0001	0
Result of CRC-16	0001 0010 0100 0001	–

2-2 Response

Slave-returned responses are classified into three types: normal response, no response, and exception response. The response message structure is the same as the query message structure.

Slave address	Function code	Data	Error check
8 bits	8 bits	Nx8 bits	16 bits

■ Normal response

Upon receiving a query from the master, the slave executes the requested process and returns a response corresponding to the function code.

■ No response

The slave may not return a response to a query sent by the master. This condition is referred to as "No response." The causes of no response are explained below.

● Transmission error

The slave discards the query if any of the transmission errors in the next table is detected. No response is returned.

Cause of transmission error	Description
Framing error	Stop bit 0 was detected.
Parity error	A mismatch with the specified parity was detected.
Mismatched CRC	The calculated value of CRC-16 was found not matching the error check value.
Invalid message length	The message length exceeded 256 bytes.

● Other than transmission error

A response may not be returned without any transmission error being detected.

Cause	Description
Broadcast	If the query was broadcast, the slave executes the requested process but does not return a response.
Mismatched slave address	When the slave address in the query is not matched the slave address of the driver.

■ Exception response

An exception response is returned if the slave cannot execute the process requested by the query. Appended to this response is an exception code indicating why the process cannot be executed. The message structure of exception response is as follows.

Slave address	Function code	Exception code	Error check
8 bits	8 bits	8 bits	16 bits

● Function code

The function code in the exception response is a sum of the function code in the query and 80h.

Function code of query	Exception response
03h	83h
06h	86h
08h	88h
10h	90h
17h	97h

● **Example of exception response**

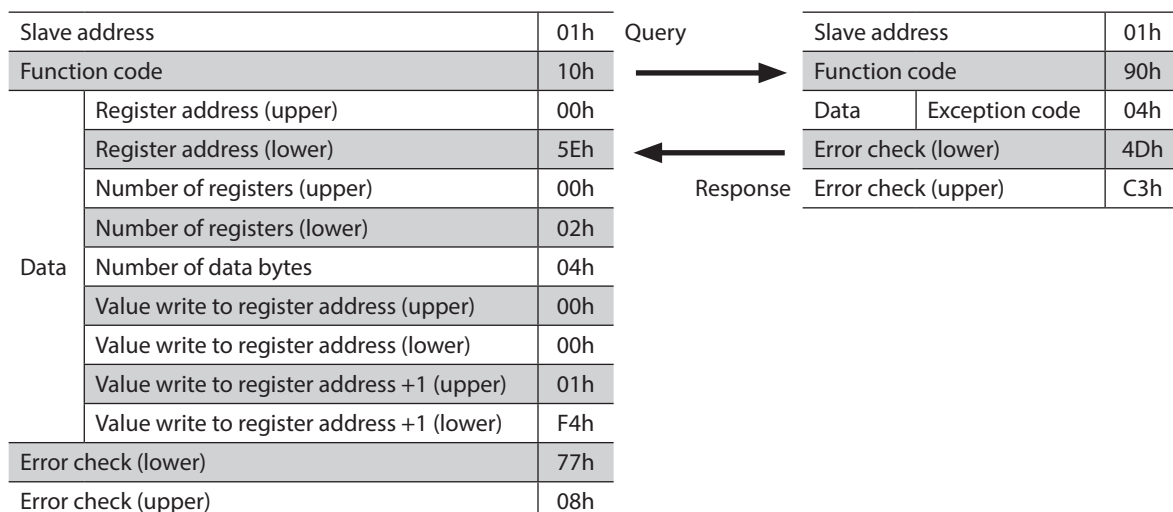

● **Exception code**

This code indicates why the process cannot be executed.

Exception code	Communication error code	Cause	Description
01h	88h	Invalid function	The process could not be executed because the function code was invalid. <ul style="list-style-type: none"> • The function code is not supported. • The sub-function code for diagnosis (08h) is other than 00h.
02h	88h	Invalid data address	The process could not be executed because the data address was invalid. <ul style="list-style-type: none"> • The register address and the number of registers exceeded FFFFh in total.
03h	8Ch	Invalid data	The process could not be executed because the data was invalid. <ul style="list-style-type: none"> • The number of registers is 0. • The number of bytes is other than "the number of register x2." • Invalid data length
04h	89h 8Ah 8Ch 8Dh	Slave error	The process could not be executed because an error occurred at the slave. <ul style="list-style-type: none"> • Communication with user I/F is in progress (89h). Execute the following with the support software <ul style="list-style-type: none"> - Data writing (under writing to the driver) - Initialization - Configuration - I/O test or remote operation • NV memory processing in progress (8Ah) <ul style="list-style-type: none"> - Internal processing is in progress (SYS-BSY is ON). - An alarm of "EEPROM error" is present. • Outside the parameter setting range (8Ch) <ul style="list-style-type: none"> The value write is outside the setting range. • Command execute disable (8Dh)

● **About slave error**

When the "Slave error response mode (Modbus)" parameter is set to "0: Normal response," even if the slave error occurs, a normal response is returned. Set it when no exception response is required, as in the case of a touch screen.

3 Function code

This chapter explains the function codes supported by the driver.

Note that function codes other than those described here cannot be executed even if they are sent.

3-1 Reading from a holding register(s) (03h)

This function code is used to read a register (16 bits). Up to 125 successive registers (125×16 bits) can be read. Read the upper and lower data at the same time. If they are not read at the same time, the value may be invalid. When multiple holding registers are read, they are read in order of register addresses.

■ Example of read

Read "Driver temperature" and "Motor temperature" of the slave address 1.

Description	Register address	Value read	Corresponding decimal
Driver temperature (upper)	248 (00F8h)	0000h	383
Driver temperature (lower)	249 (00F9h)	017Fh	
Motor temperature (upper)	250 (00FAh)	0000h	426
Motor temperature (lower)	251 (00FBh)	01AAh	

● Query

Field name		Data	Description
Slave address		01h	Slave address 1
Function code		03h	Reading from holding registers
Data	Register address (upper)	00h	Register address to start reading from
	Register address (lower)	F8h	
	Number of registers (upper)	00h	Number of registers to be read from the starting register address (4 registers=0004h)
	Number of registers (lower)	04h	
Error check (lower)		C5h	Calculation result of CRC-16
Error check (upper)		F8h	

● Response

Field name		Data	Description
Slave address		01h	Same as query
Function code		03h	Same as query
Data	Number of data bytes	08h	Twice the number of registers in the query
	Value read from register address (upper)	00h	Value read from register address 00F8h
	Value read from register address (lower)	00h	
	Value read from register address +1 (upper)	01h	Value read from register address 00F9h
	Value read from register address +1 (lower)	7Fh	
	Value read from register address +2 (upper)	00h	Value read from register address 00FAh
	Value read from register address +2 (lower)	00h	
	Value read from register address +3 (upper)	01h	Value read from register address 00FBh
Value read from register address +3 (lower)	AAh		
Error check (lower)		00h	Calculation result of CRC-16
Error check (upper)		23h	

3-2 Writing to a holding register (06h)

This function code is used to write data to a specified register address. However, since the result combining the upper and lower may be outside the data range, write the upper and lower at the same time using the "Writing to multiple holding registers (10h)."

■ Example of write

Write 80 (50h) to the command filter time constant of the slave address 2.

Description	Register address	Value write	Corresponding decimal
Command filter time constant (lower)	597 (255h)	0050h	80

● Query

Field name	Data	Description
Slave address	02h	Slave address 2
Function code	06h	Writing to a holding register
Data	Register address (upper)	02h
	Register address (lower)	55h
	Value write (upper)	00h
	Value write (lower)	50h
Error check (lower)	98h	Calculation result of CRC-16
Error check (upper)	6Dh	

● Response

Field name	Data	Description
Slave address	02h	Same as query
Function code	06h	Same as query
Data	Register address (upper)	02h
	Register address (lower)	55h
	Value write (upper)	00h
	Value write (lower)	50h
Error check (lower)	98h	Calculation result of CRC-16
Error check (upper)	6Dh	

3-3 Diagnosis (08h)

This function code is used to diagnose the communication between a master and a slave. Arbitrary data is sent and the result of returned data is used to determine whether the communication is normal. 00h (reply to query) is the only sub-function.

■ Example of diagnosis

Send arbitrary data (1234h) to the slave for diagnosis.

● Query

Field name		Data	Description
Slave address		03h	Slave address 3
Function code		08h	Diagnosis
Data	Sub-function code (upper)	00h	Return the query data
	Sub-function code (lower)	00h	
	Data value (upper)	12h	Arbitrary data (1234h)
	Data value (lower)	34h	
Error check (lower)		ECh	Calculation result of CRC-16
Error check (upper)		9Eh	

● Response

Field name		Data	Description
Slave address		03h	Same as query
Function code		08h	Same as query
Data	Sub-function code (upper)	00h	Same as query
	Sub-function code (lower)	00h	
	Data value (upper)	12h	Same as query
	Data value (lower)	34h	
Error check (lower)		ECh	Same as query
Error check (upper)		9Eh	

3-4 Writing to multiple holding registers (10h)

This function code is used to write data to multiple successive registers. Up to 123 registers can be written. Write the data to the upper and lower at the same time. If not, an invalid value may be written.

Registers are written in order of register addresses. Note that even when an exception response is returned because some data is invalid as being outside the specified range, etc., other data may have been written properly.

■ Example of write

Set the following data to the "Operating velocity," "Acceleration rate," and "Deceleration rate" of direct data operation in the slave address 4.

Description	Register address	Value write	Corresponding decimal
Direct data operation operating velocity (upper)	94 (005Eh)	0000h	1,000
Direct data operation operating velocity (lower)	95 (005Fh)	03E8h	
Direct data operation acceleration rate (upper)	96 (0060h)	0000h	1,000
Direct data operation acceleration rate (lower)	97 (0061h)	03E8h	
Direct data operation deceleration rate (upper)	98 (0062h)	0000h	2,000
Direct data operation deceleration rate (lower)	99 (0063h)	07D0h	

- Query

Field name		Data	Description	
Slave address		04h	Slave address 4	
Function code		10h	Writing to multiple holding registers	
Data	Register address (upper)	00h	Register address to start writing from	
	Register address (lower)	5Eh		
	Number of registers (upper)	00h	Number of registers to be written from the starting register address (6 registers=0006h)	
	Number of registers (lower)	06h		
	Number of data bytes		0Ch	Twice the number of registers in the query
	Value write to register address (upper)		00h	Value written to register address 005Eh
	Value write to register address (lower)		00h	
	Value write to register address +1 (upper)		03h	Value written to register address 005Fh
	Value write to register address +1 (lower)		E8h	
	Value write to register address +2 (upper)		00h	Value written to register address 0060h
	Value write to register address +2 (lower)		00h	
	Value write to register address +3 (upper)		03h	Value written to register address 0061h
	Value write to register address +3 (lower)		E8h	
	Value write to register address +4 (upper)		00h	Value written to register address 0062h
	Value write to register address +4 (lower)		00h	
Value write to register address +5 (upper)		07h	Value written to register address 0063h	
Value write to register address +5 (lower)		D0h		
Error check (lower)		43h	Calculation result of CRC-16	
Error check (upper)		C0h		

- Response

Field name		Data	Description
Slave address		04h	Same as query
Function code		10h	Same as query
Data	Register address (upper)	00h	Same as query
	Register address (lower)	5Eh	
	Number of registers (upper)	00h	Same as query
	Number of registers (lower)	06h	
Error check (lower)		21h	Calculation result of CRC-16
Error check (upper)		8Ch	

3-5 Read/write of multiple holding registers (17h)

With a single function code, reading data and writing data for multiple successive registers can be performed. Data is written first, and then data is read from the specified registers.

■ Read

Data can be read from successive registers of up to 125.

Read the upper and lower data at the same time. If they are not read at the same time, the value may be invalid. If multiple registers are read, they are read in order of register addresses.

■ Write

Data can be written to successive registers of up to 121.

Write the data to the upper and lower at the same time. If not, an invalid value may be written.

Registers are written in order of register addresses. Note that even when an exception response is returned because some data is invalid as being outside the specified range, etc., other data may have been written properly.

■ Example of read/write

Prepare the read address and write address in a single query.

In this example, after writing the data to the "Operating velocity," "Acceleration rate," and "Deceleration rate" of direct data operation in the slave address 1, read the present temperatures for the driver and the motor.

Description	Register address	Value write	Corresponding decimal
Direct data operation operating velocity (upper)	94 (005Eh)	0000h	1,000
Direct data operation operating velocity (lower)	95 (005Fh)	03E8h	
Direct data operation acceleration rate (upper)	96 (0060h)	0000h	1,000
Direct data operation acceleration rate (lower)	97 (0061h)	03E8h	
Direct data operation deceleration rate (upper)	98 (0062h)	0000h	2,000
Direct data operation deceleration rate (lower)	99 (0063h)	07D0h	

Description	Register address	Value read	Corresponding decimal
Driver temperature (upper)	248 (00F8h)	0000h	383
Driver temperature (lower)	249 (00F9h)	017Fh	
Motor temperature (upper)	250 (00FAh)	0000h	426
Motor temperature (lower)	251 (00FBh)	01AAh	

- Query

Field name		Data	Description
Slave address		01h	Slave address 1
Function code		17h	Read/write of multiple holding registers
Data	(Read) Register address (upper)	00h	Register address to start reading from
	(Read) Register address (lower)	F8h	
	(Read) Number of registers (upper)	00h	Number of registers to be read from the starting register address (4 registers=0004h)
	(Read) Number of registers (lower)	04h	
	(Write) Register address (upper)	00h	Register address to start writing from
	(Write) Register address (lower)	5Eh	
	(Write) Number of registers (upper)	00h	Number of registers to be written from the starting register address (6 registers=0006h)
	(Write) Number of registers (lower)	06h	
	(Write) Number of data bytes	0Ch	Twice the number of registers in the query
	(Write) Value write to register address (upper)	00h	Value written to register address 005Eh
	(Write) Value write to register address (lower)	00h	
	(Write) Value write to register address +1 (upper)	03h	Value written to register address 005Fh
	(Write) Value write to register address +1 (lower)	E8h	
	(Write) Value write to register address +2 (upper)	00h	Value written to register address 0060h
	(Write) Value write to register address +2 (lower)	00h	
	(Write) Value write to register address +3 (upper)	03h	Value written to register address 0061h
	(Write) Value write to register address +3 (lower)	E8h	
	(Write) Value write to register address +4 (upper)	00h	Value written to register address 0062h
(Write) Value write to register address +4 (lower)	00h		
(Write) Value write to register address +5 (upper)	07h	Value written to register address 0063h	
(Write) Value write to register address +5 (lower)	D0h		
Error check (lower)		C6h	Calculation result of CRC-16
Error check (upper)		00h	

- Response

Field name		Data	Description
Slave address		01h	Same as query
Function code		17h	Same as query
Data	(Read) Number of data bytes	08h	Twice the number of (Read) registers in the query
	(Read) Value read from register address (upper)	00h	Value read from register address 00F8h
	(Read) Value read from register address (lower)	00h	
	(Read) Value read from register address +1 (upper)	01h	Value read from register address 00F9h
	(Read) Value read from register address +1 (lower)	7Fh	
	(Read) Value read from register address +2 (upper)	00h	Value read from register address 00FAh
	(Read) Value read from register address +2 (lower)	00h	
	(Read) Value read from register address +3 (upper)	01h	Value read from register address 00FBh
(Read) Value read from register address +3 (lower)	AAh		
Error check (lower)		40h	Calculation result of CRC-16
Error check (upper)		63h	

4 Flow of settings necessary for Modbus communication

Details of are described in this part.

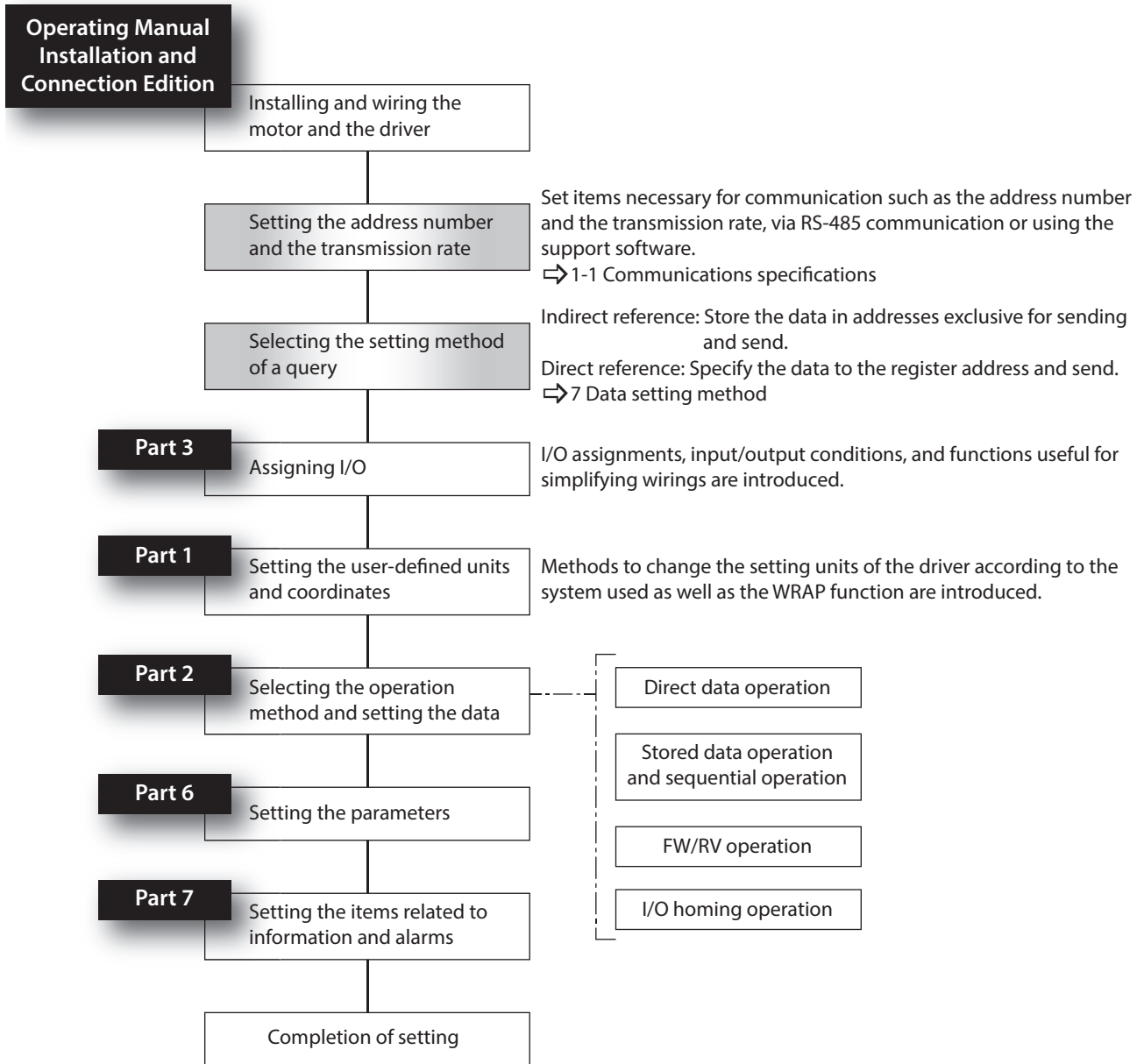

5 Setting of RS-485 communication

Set parameters necessary for RS-485 communication before performing communication.

5-1 Parameters updated when turning on the main power supply

These are parameters related to sending and receiving via RS-485 communication.

- They are out of the range of Configuration.
- They are not initialized even if "Batch data initialization" of the maintenance command is executed.
- They are initialized if "All data batch initialization" of the maintenance command is executed. If the main power supply is turned on again after "All data batch initialization" was executed, the communication setting may be changed, thereby causing communication to disable.
- They are initialized if "Reset" of the support software is executed.

Register address		Name	Description	Initial setting	
Upper	Lower			Initial value	Unit
994 (03E2h)	995 (03E3h)	Communication I/F mode selection	Sets the communication protocol. [Setting range] –1: Disable 2: Modbus RTU (RS-485 communication) 3: CANopen (CAN) 4: CANopen (CAN) & Modbus RTU (RS-485 communication)	4	–
4992 (1380h)	4993 (1381h)	Slave address (Modbus) *	Sets the address number (slave address). [Setting range] –1: Follow ID-SEL input (ID = ID-SEL value + 1) 1 to 31: Slave addresses 1 to 31 ※ Do not use 0.	–1	–
4994 (1382h)	4995 (1383h)	Baudrate (Modbus) *	Sets the transmission rate. [Setting range] 0: 9,600 bps 1: 19,200 bps 2: 38,400 bps 3: 57,600 bps 4: 115,200 bps 5: 230,400 bps	5	–
4996 (1384h)	4997 (1385h)	Byte & word order (Modbus) *	Sets the byte order of 32-bit data. Set when the arrangement of communication data is different from the master. (Setting example ⇨ p.236) [Setting range] 0: Even Address-High Word & Big-Endian 1: Even Address-Low Word & Big-Endian 2: Even Address-High Word & Little-Endian 3: Even Address-Low Word & Little-Endian	0	–
4998 (1386h)	4999 (1387h)	Communication parity (Modbus) *	Sets the communication parity. [Setting range] 0: None 1: Even parity 2: Odd parity	1	–
5000 (1388h)	5001 (1389h)	Communication stop bit (Modbus) *	Sets the communication stop bit. [Setting range] 0: 1 bit 1: 2 bits	0	–
5006 (138Eh)	5007 (138Fh)	Transmission waiting time (Modbus) *	Sets the transmission waiting time for RS-485 communication. [Setting range] 0 to 10,000 (1=0.1 ms)	30	1=0.1 ms

Register address		Name	Description	Initial setting	
Upper	Lower			Initial value	Unit
5008 (1390h)	5009 (1391h)	Silent interval (Modbus) *	Sets the silent interval. [Setting range] 0: Set automatically 1 to 100 (1=0.1 ms)	0	1=0.1 ms

* When writing is performed with the support software, the value written is immediately updated.

■ Setting example of "Byte & word order (Modbus)" parameter

When 32-bit data "1234 5678h" is stored in the register address 1000h and 1001h, the arrangement changes to the following according to the setting of the parameter.

Parameter setting	1000h (even number address)		1001h (odd number address)	
	Upper	Lower	Upper	Lower
0: Even Address-High Word & Big-Endian	12h	34h	56h	78h
1: Even Address-Low Word & Big-Endian	56h	78h	12h	34h
2: Even Address-High Word & Little-Endian	34h	12h	78h	56h
3: Even Address-Low Word & Little-Endian	78h	56h	34h	12h



This manual describes based on "0: Even Address-High Word & Big-Endian."

5-2 Parameters updated immediately after overriding

Set the following parameters using the support software or via RS-485 communication.

Register address		Name	Description	Initial setting	
Upper	Lower			Initial value	Unit
5002 (138Ah)	5003 (138Bh)	Communication timeout (Modbus)	Sets the condition in which a communication timeout occurs in RS-485 communication. [Setting range] 0: Not monitored 1 to 10,000 ms	0	ms
5004 (138Ch)	5005 (138Dh)	Communication error detection (Modbus)	A communication error alarm is generated when the RS-485 communication error has occurred by the number of times set here. [Setting range] 0: Disable 1 to 10 times	3	–
5010 (1392h)	5011 (1393h)	Slave error response mode (Modbus)	Sets the response when the slave error occurred. [Setting range] 0: Normal response 1: Exception response	1	–
5056 (13C0h)	5057 (13C1h)	RS-485 communication frame monitor target ID	Sets the monitor axis in the RS-485 communication frame monitor of the support software. [Setting range] 1 to 127: Slave address 1 to 127	1	–



To communicate with the driver periodically, set the "Communication timeout (Modbus)" parameter. Setting the parameter can make an alarm of "RS-485 communication timeout" generate if communication between the master and the driver is disconnected.

6 Setting example of data in Modbus RTU mode

6-1 Remote I/O commands

These are commands related to remote I/O. The set value is stored in RAM.

Modbus communication register address		Name	Description	R/W	Initial setting		NET-ID
Upper	Lower				Initial value	Unit	
114 (0072h)	115 (0073h)	NET selection data number	Selects the operation data number. Operation data can be sent at the same time as "Driver input command (2nd)."	R/W	-1	-	57 (0039h)
116 (0074h)	117 (0075h)	Driver input command (2nd)	The same input command as "Driver input command" is automatically set.	R/W	0	-	58 (003Ah)
118 (0076h)	119 (0077h)	NET selection data number	Selects the operation data number. Operation data can be sent at the same time as "Driver input command (automatic OFF)."	R/W	-1	-	59 (003Bh)
120 (0078h)	121 (0079h)	Driver input command (automatic OFF)	The same input command as "Driver input command" is automatically set. If the input signal is turned ON with this command, it is automatically turned OFF after 250 μ s.	R/W	0	-	60 (003Ch)
122 (007Ah)	123 (007Bh)	NET selection data number	Selects the operation data number. Operation data can be sent at the same time as "Driver input command."	R/W	-1	-	61 (003Dh)
124 (007Ch)	125 (007Dh)	Driver input command	Sets the input command to the driver. (Details of bits arrangement \Rightarrow Next section)	R/W	0	-	62 (003Eh)
126 (007Eh)	127 (007Fh)	Driver output status	Reads the output status of the driver. (Details of bits arrangement \Rightarrow p.239)	R	-	-	63 (003Fh)

■ Driver input command

These are the driver input signals that can be accessed via Modbus communication. They can also be accessed in units of one register (16 bits).

Values in brackets [] are initial values.

They can be changed using the parameter. (Parameters ⇨ p.381, assignment of input signals ⇨ p.151)

● Upper

Register address	Description							
124 (007Ch)	bit15	bit14	bit13	bit12	bit11	bit10	bit9	bit8
	R-IN31 [M7]	R-IN30 [M6]	R-IN29 [M5]	R-IN28 [M4]	R-IN27 [M3]	R-IN26 [M2]	R-IN25 [M1]	R-IN24 [M0]
	bit7	bit6	bit5	bit4	bit3	bit2	bit1	bit0
	R-IN23 [SSTART]	R-IN22 [START]	R-IN21 [Not used]	R-IN20 [HOME]	R-IN19 [RV-SPD]	R-IN18 [FW-SPD]	R-IN17 [RV-JOG-P]	R-IN16 [FW-JOG-P]

● Lower

Register address	Description							
125 (007Dh)	bit15	bit14	bit13	bit12	bit11	bit10	bit9	bit8
	R-IN15 [D-SEL7]	R-IN14 [D-SEL6]	R-IN13 [D-SEL5]	R-IN12 [D-SEL4]	R-IN11 [D-SEL3]	R-IN10 [D-SEL2]	R-IN9 [D-SEL1]	R-IN8 [D-SEL0]
	bit7	bit6	bit5	bit4	bit3	bit2	bit1	bit0
	R-IN7 [ALM-RST]	R-IN6 [FREE]	R-IN5 [STOP]	R-IN4 [QSTOP]	R-IN3 [CLR]	R-IN2 [TRQ-LMT]	R-IN1 [PLOOP-MODE]	R-IN0 [S-ON]

 Input "0" for the bit that "Not used" is set.

■ Driver output status

These are the driver output signals that can be accessed via Modbus communication. They can also be accessed in units of one register (16 bits).

Values in brackets [] are initial values.

They can be changed using the parameter. (Parameters ⇨ p.381, assignment of output signals ⇨ p.154)

● Upper

Register address	Description							
	bit15	bit14	bit13	bit12	bit11	bit10	bit9	bit8
126 (007Eh)	R-OUT31 [USR-OUT1]	R-OUT30 [USR-OUT0]	R-OUT29 [CONST-OFF]	R-OUT28 [CONST-OFF]	R-OUT27 [CONST-OFF]	R-OUT26 [CONST-OFF]	R-OUT25 [INFO- USRIO-G]	R-OUT24 [INFO- START-G]
	bit7	bit6	bit5	bit4	bit3	bit2	bit1	bit0
	R-OUT23 [INFO-VOLT-L]	R-OUT22 [INFO-VOLT-H]	R-OUT21 [INFO-WATT]	R-OUT20 [INFO-TRQ]	R-OUT19 [INFO- MTRTMP]	R-OUT18 [INFO- DRVTMP]	R-OUT17 [INFO-MNT-G]	R-OUT16 [INFO]

● Lower

Register address	Description							
	bit15	bit14	bit13	bit12	bit11	bit10	bit9	bit8
127 (007Fh)	R-OUT15 [TLC]	R-OUT14 [VA]	R-OUT13 [MOVE]	R-OUT12 [RDY-SD-OPE]	R-OUT11 [RDY-FWRV-OPE]	R-OUT10 [RDY-HOME-OPE]	R-OUT9 [IN-POS]	R-OUT8 [SYS-BSY]
	bit7	bit6	bit5	bit4	bit3	bit2	bit1	bit0
	R-OUT7 [ALM-A]	R-OUT6 [FREE_R]	R-OUT5 [STOP_R]	R-OUT4 [ABSPEN]	R-OUT3 [RDY-DD-OPE]	R-OUT2 [TRQ-LMTD]	R-OUT1 [PLOOP-MON]	R-OUT0 [SON-MON]

7 Data setting method

7-1 Overview of setting methods

There are two methods to set data via Modbus communication.
 The communication specifications of Modbus allows reading/writing from/to successive addresses when multiple data pieces are handled.

Input method	Features
Direct reference	<ul style="list-style-type: none"> • This is a method to read or write by specifying the register addresses of parameters or commands directly. • Multiple times of queries are required to send when reading/writing from/to multiple register addresses. (For successive register addresses, sending one query can read/write from/to multiple register addresses.)
Indirect reference	<ul style="list-style-type: none"> • This method requires to register the register addresses to be read or written in indirect reference addresses. • Sending one query can read/write from/to multiple register addresses because the register addresses in the indirect reference area are successive.

Example) When writing to the "Direct data operation zero velocity command action," "Command filter time constant," and "MOVE minimum ON time" parameters.

Direct reference

To write to the parameters, a query is required to send three times.

Register address		Setting target	
Upper	Lower		
544 (0220h)	545 (0221h)	Direct data operation zero velocity command action	→ Query 1)
•	•	•	•
596 (0254h)	597 (0255h)	Command filter time constant	→ Query 2)
•	•	•	•
3604 (0E14h)	3605 (0E15h)	MOVE minimum ON time	→ Query 3)

Indirect reference

1. Register the "Direct data operation zero velocity command action," "Command filter time constant," and "MOVE minimum ON time" parameters in indirect reference addresses.

Register address		Setting target	Parameter to be set	
Upper	Lower		Setting value *	Parameter name
4864 (1300h)	4865 (1301h)	Indirect reference address (0)	272 (0110h)	Direct data operation zero velocity command action
4866 (1302h)	4867 (1303h)	Indirect reference address (1)	298 (012Ah)	Command filter time constant
4868 (1304h)	4869 (1305h)	Indirect reference address (2)	1802 (070Ah)	MOVE minimum ON time

* Set the value of NET-ID of each parameter.

2. Send a query to the indirect reference areas 0 to 2.

Register address		Setting target	
Upper	Lower		
4928 (1340h)	4929 (1341h)	Indirect reference area 0 (Direct data operation zero velocity command action)	→ Query *
4930 (1342h)	4931 (1343h)	Indirect reference area 1 (Command filter time constant)	
4932 (1344h)	4933 (1345h)	indirect reference area 2 (MOVE minimum ON time)	

* Sending one query can write because the register addresses are successive.



Refer to "Setting example" on p.253 for the setting example.

7-2 Direct reference

This is a method to read or write by specifying the register addresses of parameters or commands directly. Multiple times of queries are required to send when reading/writing from/to multiple register addresses. For successive register addresses, sending one query can read/write from/to multiple register addresses.

7-3 Indirect reference

Sending one query can read/write from/to multiple register addresses because the register addresses in the indirect reference area are successive.
However, this method requires to register the register addresses to be read or written in indirect reference addresses.

■ Addresses and areas of indirect reference

Indirect reference has 128 addresses and 128 areas (0 to 127).

Name	Description
Indirect reference address (0)	Sets parameters or commands to be read or written in indirect reference. Set the value of NET-ID of the parameters or commands to be read or written.
Indirect reference address (1)	
⋮	
Indirect reference address (126)	
Indirect reference address (127)	
Indirect reference area 0	
Indirect reference area 1	This is an area to read/write from/to the parameter or command registered in the indirect reference address (1).
⋮	⋮
Indirect reference area 126	This is an area to read/write from/to the parameter or command registered in the indirect reference address (126).
Indirect reference area 127	This is an area to read/write from/to the parameter or command registered in the indirect reference address (127).

● Indirect reference address setting

Register address		Name	Description	Initial setting	
Upper	Lower			Initial value	Unit
1536 (0600h)	1537 (0601h)	Indirect reference address setting (0)	Sets NET-ID of commands or parameters to be registered in the indirect reference addresses. [Setting range] 0 to 65,535 (0 to FFFFh)	0	-
1538 (0602h)	1539 (0603h)	Indirect reference address setting (1)			
1540 (0604h)	1541 (0605h)	Indirect reference address setting (2)			
1542 (0606h)	1543 (0607h)	Indirect reference address setting (3)			
1544 (0608h)	1545 (0609h)	Indirect reference address setting (4)			
1546 (060Ah)	1547 (060Bh)	Indirect reference address setting (5)			
1548 (060Ch)	1549 (060Dh)	Indirect reference address setting (6)			
1550 (060Eh)	1551 (060Fh)	Indirect reference address setting (7)			
1552 (0610h)	1553 (0611h)	Indirect reference address setting (8)			
1554 (0612h)	1555 (0613h)	Indirect reference address setting (9)			
1556 (0614h)	1557 (0615h)	Indirect reference address setting (10)			

Register address		Name	Description	Initial setting	
Upper	Lower			Initial value	Unit
1558 (0616h)	1559 (0617h)	Indirect reference address setting (11)	Sets NET-ID of commands or parameters to be registered in the indirect reference addresses. [Setting range] 0 to 65,535 (0 to FFFFh)	0	-
1560 (0618h)	1561 (0619h)	Indirect reference address setting (12)			
1562 (061Ah)	1563 (061Bh)	Indirect reference address setting (13)			
1564 (061Ch)	1565 (061Dh)	Indirect reference address setting (14)			
1566 (061Eh)	1567 (061Fh)	Indirect reference address setting (15)			
1568 (0620h)	1569 (0621h)	Indirect reference address setting (16)			
1570 (0622h)	1571 (0623h)	Indirect reference address setting (17)			
1572 (0624h)	1573 (0625h)	Indirect reference address setting (18)			
1574 (0626h)	1575 (0627h)	Indirect reference address setting (19)			
1576 (0628h)	1577 (0629h)	Indirect reference address setting (20)			
1578 (062Ah)	1579 (062Bh)	Indirect reference address setting (21)			
1580 (062Ch)	1581 (062Dh)	Indirect reference address setting (22)			
1582 (062Eh)	1583 (062Fh)	Indirect reference address setting (23)			
1584 (0630h)	1585 (0631h)	Indirect reference address setting (24)			
1586 (0632h)	1587 (0633h)	Indirect reference address setting (25)			
1588 (0634h)	1589 (0635h)	Indirect reference address setting (26)			
1590 (0636h)	1591 (0637h)	Indirect reference address setting (27)			
1592 (0638h)	1593 (0639h)	Indirect reference address setting (28)			
1594 (063Ah)	1595 (063Bh)	Indirect reference address setting (29)			
1596 (063Ch)	1597 (063Dh)	Indirect reference address setting (30)			
1598 (063Eh)	1599 (063Fh)	Indirect reference address setting (31)			
1600 (0640h)	1601 (0641h)	Indirect reference address setting (32)			
1602 (0642h)	1603 (0643h)	Indirect reference address setting (33)			
1604 (0644h)	1605 (0645h)	Indirect reference address setting (34)			
1606 (0646h)	1607 (0647h)	Indirect reference address setting (35)			
1608 (0648h)	1609 (0649h)	Indirect reference address setting (36)			

Register address		Name	Description	Initial setting	
Upper	Lower			Initial value	Unit
1610 (064Ah)	1611 (064Bh)	Indirect reference address setting (37)	Sets NET-ID of commands or parameters to be registered in the indirect reference addresses. [Setting range] 0 to 65,535 (0 to FFFFh)	0	-
1612 (064Ch)	1613 (064Dh)	Indirect reference address setting (38)			
1614 (064Eh)	1615 (064Fh)	Indirect reference address setting (39)			
1616 (0650h)	1617 (0651h)	Indirect reference address setting (40)			
1618 (0652h)	1619 (0653h)	Indirect reference address setting (41)			
1620 (0654h)	1621 (0655h)	Indirect reference address setting (42)			
1622 (0656h)	1623 (0657h)	Indirect reference address setting (43)			
1624 (0658h)	1625 (0659h)	Indirect reference address setting (44)			
1626 (065Ah)	1627 (065Bh)	Indirect reference address setting (45)			
1628 (065Ch)	1629 (065Dh)	Indirect reference address setting (46)			
1630 (065Eh)	1631 (065Fh)	Indirect reference address setting (47)			
1632 (0660h)	1633 (0661h)	Indirect reference address setting (48)			
1634 (0662h)	1635 (0663h)	Indirect reference address setting (49)			
1636 (0664h)	1637 (0665h)	Indirect reference address setting (50)			
1638 (0666h)	1639 (0667h)	Indirect reference address setting (51)			
1640 (0668h)	1641 (0669h)	Indirect reference address setting (52)			
1642 (066Ah)	1643 (066Bh)	Indirect reference address setting (53)			
1644 (066Ch)	1645 (066Dh)	Indirect reference address setting (54)			
1646 (066Eh)	1647 (066Fh)	Indirect reference address setting (55)			
1648 (0670h)	1649 (0671h)	Indirect reference address setting (56)			
1650 (0672h)	1651 (0673h)	Indirect reference address setting (57)			
1652 (0674h)	1653 (0675h)	Indirect reference address setting (58)			
1654 (0676h)	1655 (0677h)	Indirect reference address setting (59)			
1656 (0678h)	1657 (0679h)	Indirect reference address setting (60)			
1658 (067Ah)	1659 (067Bh)	Indirect reference address setting (61)			
1660 (067Ch)	1661 (067Dh)	Indirect reference address setting (62)			

Register address		Name	Description	Initial setting	
Upper	Lower			Initial value	Unit
1662 (067Eh)	1663 (067Fh)	Indirect reference address setting (63)	Sets NET-ID of commands or parameters to be registered in the indirect reference addresses. [Setting range] 0 to 65,535 (0 to FFFFh)	0	-
1664 (0680h)	1665 (0681h)	Indirect reference address setting (64)			
1666 (0682h)	1667 (0683h)	Indirect reference address setting (65)			
1668 (0684h)	1669 (0685h)	Indirect reference address setting (66)			
1670 (0686h)	1671 (0687h)	Indirect reference address setting (67)			
1672 (0688h)	1673 (0689h)	Indirect reference address setting (68)			
1674 (068Ah)	1675 (068Bh)	Indirect reference address setting (69)			
1676 (068Ch)	1677 (068Dh)	Indirect reference address setting (70)			
1678 (068Eh)	1679 (068Fh)	Indirect reference address setting (71)			
1680 (0690h)	1681 (0691h)	Indirect reference address setting (72)			
1682 (0692h)	1683 (0693h)	Indirect reference address setting (73)			
1684 (0694h)	1685 (0695h)	Indirect reference address setting (74)			
1686 (0696h)	1687 (0697h)	Indirect reference address setting (75)			
1688 (0698h)	1689 (0699h)	Indirect reference address setting (76)			
1690 (069Ah)	1691 (069Bh)	Indirect reference address setting (77)			
1692 (069Ch)	1693 (069Dh)	Indirect reference address setting (78)			
1694 (069Eh)	1695 (069Fh)	Indirect reference address setting (79)			
1696 (06A0h)	1697 (06A1h)	Indirect reference address setting (80)			
1698 (06A2h)	1699 (06A3h)	Indirect reference address setting (81)			
1700 (06A4h)	1701 (06A5h)	Indirect reference address setting (82)			
1702 (06A6h)	1703 (06A7h)	Indirect reference address setting (83)			
1704 (06A8h)	1705 (06A9h)	Indirect reference address setting (84)			
1706 (06AAh)	1707 (06ABh)	Indirect reference address setting (85)			
1708 (06ACh)	1709 (06ADh)	Indirect reference address setting (86)			
1710 (06AEh)	1711 (06AFh)	Indirect reference address setting (87)			
1712 (06B0h)	1713 (06B1h)	Indirect reference address setting (88)			

Register address		Name	Description	Initial setting	
Upper	Lower			Initial value	Unit
1714 (06B2h)	1715 (06B3h)	Indirect reference address setting (89)	Sets NET-ID of commands or parameters to be registered in the indirect reference addresses. [Setting range] 0 to 65,535 (0 to FFFFh)	0	-
1716 (06B4h)	1717 (06B5h)	Indirect reference address setting (90)			
1718 (06B6h)	1719 (06B7h)	Indirect reference address setting (91)			
1720 (06B8h)	1721 (06B9h)	Indirect reference address setting (92)			
1722 (06BAh)	1723 (06BBh)	Indirect reference address setting (93)			
1724 (06BCh)	1725 (06BDh)	Indirect reference address setting (94)			
1726 (06BEh)	1727 (06BFh)	Indirect reference address setting (95)			
1728 (06C0h)	1729 (06C1h)	Indirect reference address setting (96)			
1730 (06C2h)	1731 (06C3h)	Indirect reference address setting (97)			
1732 (06C4h)	1733 (06C5h)	Indirect reference address setting (98)			
1734 (06C6h)	1735 (06C7h)	Indirect reference address setting (99)			
1736 (06C8h)	1737 (06C9h)	Indirect reference address setting (100)			
1738 (06CAh)	1739 (06CBh)	Indirect reference address setting (101)			
1740 (06CCh)	1741 (06CDh)	Indirect reference address setting (102)			
1742 (06CEh)	1743 (06CFh)	Indirect reference address setting (103)			
1744 (06D0h)	1745 (06D1h)	Indirect reference address setting (104)			
1746 (06D2h)	1747 (06D3h)	Indirect reference address setting (105)			
1748 (06D4h)	1749 (06D5h)	Indirect reference address setting (106)			
1750 (06D6h)	1751 (06D7h)	Indirect reference address setting (107)			
1752 (06D8h)	1753 (06D9h)	Indirect reference address setting (108)			
1754 (06DAh)	1755 (06DBh)	Indirect reference address setting (109)			
1756 (06DCh)	1757 (06DDh)	Indirect reference address setting (110)			
1758 (06DEh)	1759 (06DFh)	Indirect reference address setting (111)			
1760 (06E0h)	1761 (06E1h)	Indirect reference address setting (112)			
1762 (06E2h)	1763 (06E3h)	Indirect reference address setting (113)			
1764 (06E4h)	1765 (06E5h)	Indirect reference address setting (114)			

Register address		Name	Description	Initial setting	
Upper	Lower			Initial value	Unit
1766 (06E6h)	1767 (06E7h)	Indirect reference address setting (115)	Sets NET-ID of commands or parameters to be registered in the indirect reference addresses. [Setting range] 0 to 65,535 (0 to FFFFh)	0	-
1768 (06E8h)	1769 (06E9h)	Indirect reference address setting (116)			
1770 (06EAh)	1771 (06EBh)	Indirect reference address setting (117)			
1772 (06ECh)	1773 (06EDh)	Indirect reference address setting (118)			
1774 (06EEh)	1775 (06EFh)	Indirect reference address setting (119)			
1776 (06F0h)	1777 (06F1h)	Indirect reference address setting (120)			
1778 (06F2h)	1779 (06F3h)	Indirect reference address setting (121)			
1780 (06F4h)	1781 (06F5h)	Indirect reference address setting (122)			
1782 (06F6h)	1783 (06F7h)	Indirect reference address setting (123)			
1784 (06F8h)	1785 (06F9h)	Indirect reference address setting (124)			
1786 (06FAh)	1787 (06FBh)	Indirect reference address setting (125)			
1788 (06FCh)	1789 (06FDh)	Indirect reference address setting (126)			
1790 (06FEh)	1791 (06FFh)	Indirect reference address setting (127)			

● Indirect reference area

Register address		Name	Register address		Name
Upper	Lower		Upper	Lower	
1792 (0700h)	1793 (0701h)	Indirect reference area 0	1814 (0716h)	1815 (0717h)	Indirect reference area 11
1794 (0702h)	1795 (0703h)	Indirect reference area 1	1816 (0718h)	1817 (0719h)	Indirect reference area 12
1796 (0704h)	1797 (0705h)	Indirect reference area 2	1818 (071Ah)	1819 (071Bh)	Indirect reference area 13
1798 (0706h)	1799 (0707h)	Indirect reference area 3	1820 (071Ch)	1821 (071Dh)	Indirect reference area 14
1800 (0708h)	1801 (0709h)	Indirect reference area 4	1822 (071Eh)	1823 (071Fh)	Indirect reference area 15
1802 (070Ah)	1803 (070Bh)	Indirect reference area 5	1824 (0720h)	1825 (0721h)	Indirect reference area 16
1804 (070Ch)	1805 (070Dh)	Indirect reference area 6	1826 (0722h)	1827 (0723h)	Indirect reference area 17
1806 (070Eh)	1807 (070Fh)	Indirect reference area 7	1828 (0724h)	1829 (0725h)	Indirect reference area 18
1808 (0710h)	1809 (0711h)	Indirect reference area 8	1830 (0726h)	1831 (0727h)	Indirect reference area 19
1810 (0712h)	1811 (0713h)	Indirect reference area 9	1832 (0728h)	1833 (0729h)	Indirect reference area 20
1812 (0714h)	1813 (0715h)	Indirect reference area 10	1834 (072Ah)	1835 (072Bh)	Indirect reference area 21

Register address		Name	Register address		Name
Upper	Lower		Upper	Lower	
1836 (072Ch)	1837 (072Dh)	Indirect reference area 22	1890 (0762h)	1891 (0763h)	Indirect reference area 49
1838 (072Eh)	1839 (072Fh)	Indirect reference area 23	1892 (0764h)	1893 (0765h)	Indirect reference area 50
1840 (0730h)	1841 (0731h)	Indirect reference area 24	1894 (0766h)	1895 (0767h)	Indirect reference area 51
1842 (0732h)	1843 (0733h)	Indirect reference area 25	1896 (0768h)	1897 (0769h)	Indirect reference area 52
1844 (0734h)	1845 (0735h)	Indirect reference area 26	1898 (076Ah)	1899 (076Bh)	Indirect reference area 53
1846 (0736h)	1847 (0737h)	Indirect reference area 27	1900 (076Ch)	1901 (076Dh)	Indirect reference area 54
1848 (0738h)	1849 (0739h)	Indirect reference area 28	1902 (076Eh)	1903 (076Fh)	Indirect reference area 55
1850 (073Ah)	1851 (073Bh)	Indirect reference area 29	1904 (0770h)	1905 (0771h)	Indirect reference area 56
1852 (073Ch)	1853 (073Dh)	Indirect reference area 30	1906 (0772h)	1907 (0773h)	Indirect reference area 57
1854 (073Eh)	1855 (073Fh)	Indirect reference area 31	1908 (0774h)	1909 (0775h)	Indirect reference area 58
1856 (0740h)	1857 (0741h)	Indirect reference area 32	1910 (0776h)	1911 (0777h)	Indirect reference area 59
1858 (0742h)	1859 (0743h)	Indirect reference area 33	1912 (0778h)	1913 (0779h)	Indirect reference area 60
1860 (0744h)	1861 (0745h)	Indirect reference area 34	1914 (077Ah)	1915 (077Bh)	Indirect reference area 61
1862 (0746h)	1863 (0747h)	Indirect reference area 35	1916 (077Ch)	1917 (077Dh)	Indirect reference area 62
1864 (0748h)	1865 (0749h)	Indirect reference area 36	1918 (077Eh)	1919 (077Fh)	Indirect reference area 63
1866 (074Ah)	1867 (074Bh)	Indirect reference area 37	1920 (0780h)	1921 (0781h)	Indirect reference area 64
1868 (074Ch)	1869 (074Dh)	Indirect reference area 38	1922 (0782h)	1923 (0783h)	Indirect reference area 65
1870 (074Eh)	1871 (074Fh)	Indirect reference area 39	1924 (0784h)	1925 (0785h)	Indirect reference area 66
1872 (0750h)	1873 (0751h)	Indirect reference area 40	1926 (0786h)	1927 (0787h)	Indirect reference area 67
1874 (0752h)	1875 (0753h)	Indirect reference area 41	1928 (0788h)	1929 (0789h)	Indirect reference area 68
1876 (0754h)	1877 (0755h)	Indirect reference area 42	1930 (078Ah)	1931 (078Bh)	Indirect reference area 69
1878 (0756h)	1879 (0757h)	Indirect reference area 43	1932 (078Ch)	1933 (078Dh)	Indirect reference area 70
1880 (0758h)	1881 (0759h)	Indirect reference area 44	1934 (078Eh)	1935 (078Fh)	Indirect reference area 71
1882 (075Ah)	1883 (075Bh)	Indirect reference area 45	1936 (0790h)	1937 (0791h)	Indirect reference area 72
1884 (075Ch)	1885 (075Dh)	Indirect reference area 46	1938 (0792h)	1939 (0793h)	Indirect reference area 73
1886 (075Eh)	1887 (075Fh)	Indirect reference area 47	1940 (0794h)	1941 (0795h)	Indirect reference area 74
1888 (0760h)	1889 (0761h)	Indirect reference area 48	1942 (0796h)	1943 (0797h)	Indirect reference area 75

Register address		Name	Register address		Name
Upper	Lower		Upper	Lower	
1944 (0798h)	1945 (0799h)	Indirect reference area 76	1996 (07CCh)	1997 (07CDh)	Indirect reference area 102
1946 (079Ah)	1947 (079Bh)	Indirect reference area 77	1998 (07CEh)	1999 (07CFh)	Indirect reference area 103
1948 (079Ch)	1949 (079Dh)	Indirect reference area 78	2000 (07D0h)	2001 (07D1h)	Indirect reference area 104
1950 (079Eh)	1951 (079Fh)	Indirect reference area 79	2002 (07D2h)	2003 (07D3h)	Indirect reference area 105
1952 (07A0h)	1953 (07A1h)	Indirect reference area 80	2004 (07D4h)	2005 (07D5h)	Indirect reference area 106
1954 (07A2h)	1955 (07A3h)	Indirect reference area 81	2006 (07D6h)	2007 (07D7h)	Indirect reference area 107
1956 (07A4h)	1957 (07A5h)	Indirect reference area 82	2008 (07D8h)	2009 (07D9h)	Indirect reference area 108
1958 (07A6h)	1959 (07A7h)	Indirect reference area 83	2010 (07DAh)	2011 (07DBh)	Indirect reference area 109
1960 (07A8h)	1961 (07A9h)	Indirect reference area 84	2012 (07DCh)	2013 (07DDh)	Indirect reference area 110
1962 (07AAh)	1963 (07ABh)	Indirect reference area 85	2014 (07DEh)	2015 (07DFh)	Indirect reference area 111
1964 (07ACh)	1965 (07ADh)	Indirect reference area 86	2016 (07E0h)	2017 (07E1h)	Indirect reference area 112
1966 (07AEh)	1967 (07AFh)	Indirect reference area 87	2018 (07E2h)	2019 (07E3h)	Indirect reference area 113
1968 (07B0h)	1969 (07B1h)	Indirect reference area 88	2020 (07E4h)	2021 (07E5h)	Indirect reference area 114
1970 (07B2h)	1971 (07B3h)	Indirect reference area 89	2022 (07E6h)	2023 (07E7h)	Indirect reference area 115
1972 (07B4h)	1973 (07B5h)	Indirect reference area 90	2024 (07E8h)	2025 (07E9h)	Indirect reference area 116
1974 (07B6h)	1975 (07B7h)	Indirect reference area 91	2026 (07EAh)	2027 (07EBh)	Indirect reference area 117
1976 (07B8h)	1977 (07B9h)	Indirect reference area 92	2028 (07ECh)	2029 (07EDh)	Indirect reference area 118
1978 (07BAh)	1979 (07BBh)	Indirect reference area 93	2030 (07EEh)	2031 (07EFh)	Indirect reference area 119
1980 (07BCh)	1981 (07BDh)	Indirect reference area 94	2032 (07F0h)	2033 (07F1h)	Indirect reference area 120
1982 (07BEh)	1983 (07BFh)	Indirect reference area 95	2034 (07F2h)	2035 (07F3h)	Indirect reference area 121
1984 (07C0h)	1985 (07C1h)	Indirect reference area 96	2036 (07F4h)	2037 (07F5h)	Indirect reference area 122
1986 (07C2h)	1987 (07C3h)	Indirect reference area 97	2038 (07F6h)	2039 (07F7h)	Indirect reference area 123
1988 (07C4h)	1989 (07C5h)	Indirect reference area 98	2040 (07F8h)	2041 (07F9h)	Indirect reference area 124
1990 (07C6h)	1991 (07C7h)	Indirect reference area 99	2042 (07FAh)	2043 (07FBh)	Indirect reference area 125
1992 (07C8h)	1993 (07C9h)	Indirect reference area 100	2044 (07FCh)	2045 (07FDh)	Indirect reference area 126
1994 (07CAh)	1995 (07CBh)	Indirect reference area 101	2046 (07FEh)	2047 (07FFh)	Indirect reference area 127

■ Addresses and areas of indirect reference (compatible)

The function is the same as the indirect reference address and the indirect reference area.
Use when replacing from our existing product.

● Indirect reference address setting (compatible)

Register address		Name	Description	Initial setting	
Upper	Lower			Initial value	Unit
4864 (1300h)	4865 (1301h)	Indirect reference address setting (0) (compatible)	Sets NET-ID of commands or parameters to be registered in the indirect reference addresses. [Setting range] 0 to 65,535 (0 to FFFFh)	0	-
4866 (1302h)	4867 (1303h)	Indirect reference address setting (1) (compatible)			
4868 (1304h)	4869 (1305h)	Indirect reference address setting (2) (compatible)			
4870 (1306h)	4871 (1307h)	Indirect reference address setting (3) (compatible)			
4872 (1308h)	4873 (1309h)	Indirect reference address setting (4) (compatible)			
4874 (130Ah)	4875 (130Bh)	Indirect reference address setting (5) (compatible)			
4876 (130Ch)	4877 (130Dh)	Indirect reference address setting (6) (compatible)			
4878 (130Eh)	4879 (130Fh)	Indirect reference address setting (7) (compatible)			
4880 (1310h)	4881 (1311h)	Indirect reference address setting (8) (compatible)			
4882 (1312h)	4883 (1313h)	Indirect reference address setting (9) (compatible)			
4884 (1314h)	4885 (1315h)	Indirect reference address setting (10) (compatible)			
4886 (1316h)	4887 (1317h)	Indirect reference address setting (11) (compatible)			
4888 (1318h)	4889 (1319h)	Indirect reference address setting (12) (compatible)			
4890 (131Ah)	4891 (131Bh)	Indirect reference address setting (13) (compatible)			
4892 (131Ch)	4893 (131Dh)	Indirect reference address setting (14) (compatible)			
4894 (131Eh)	4895 (131Fh)	Indirect reference address setting (15) (compatible)			
4896 (1320h)	4897 (1321h)	Indirect reference address setting (16) (compatible)			
4898 (1322h)	4899 (1323h)	Indirect reference address setting (17) (compatible)			
4900 (1324h)	4901 (1325h)	Indirect reference address setting (18) (compatible)			
4902 (1326h)	4903 (1327h)	Indirect reference address setting (19) (compatible)			
4904 (1328h)	4905 (1329h)	Indirect reference address setting (20) (compatible)			
4906 (132Ah)	4907 (132Bh)	Indirect reference address setting (21) (compatible)			

Register address		Name	Description	Initial setting	
Upper	Lower			Initial value	Unit
4908 (132Ch)	4909 (132Dh)	Indirect reference address setting (22) (compatible)	Sets NET-ID of commands or parameters to be registered in the indirect reference addresses. [Setting range] 0 to 65,535 (0 to FFFFh)	0	-
4910 (132Eh)	4911 (132Fh)	Indirect reference address setting (23) (compatible)			
4912 (1330h)	4913 (1331h)	Indirect reference address setting (24) (compatible)			
4914 (1332h)	4915 (1333h)	Indirect reference address setting (25) (compatible)			
4916 (1334h)	4917 (1335h)	Indirect reference address setting (26) (compatible)			
4918 (1336h)	4919 (1337h)	Indirect reference address setting (27) (compatible)			
4920 (1338h)	4921 (1339h)	Indirect reference address setting (28) (compatible)			
4922 (133Ah)	4923 (133Bh)	Indirect reference address setting (29) (compatible)			
4924 (133Ch)	4925 (133Dh)	Indirect reference address setting (30) (compatible)			
4926 (133Eh)	4927 (133Fh)	Indirect reference address setting (31) (compatible)			

- Indirect reference area (compatible)

Register address		Name
Upper	Lower	
4928 (1340h)	4929 (1341h)	Indirect reference area 0 (compatible)
4930 (1342h)	4931 (1343h)	Indirect reference area 1 (compatible)
4932 (1344h)	4933 (1345h)	Indirect reference area 2 (compatible)
4934 (1346h)	4935 (1347h)	Indirect reference area 3 (compatible)
4936 (1348h)	4937 (1349h)	Indirect reference area 4 (compatible)
4938 (134Ah)	4939 (134Bh)	Indirect reference area 5 (compatible)
4940 (134Ch)	4941 (134Dh)	Indirect reference area 6 (compatible)
4942 (134Eh)	4943 (134Fh)	Indirect reference area 7 (compatible)
4944 (1350h)	4945 (1351h)	Indirect reference area 8 (compatible)
4946 (1352h)	4947 (1353h)	Indirect reference area 9 (compatible)
4948 (1354h)	4949 (1355h)	Indirect reference area 10 (compatible)
4950 (1356h)	4951 (1357h)	Indirect reference area 11 (compatible)
4952 (1358h)	4953 (1359h)	Indirect reference area 12 (compatible)
4954 (135Ah)	4955 (135Bh)	Indirect reference area 13 (compatible)
4956 (135Ch)	4957 (135Dh)	Indirect reference area 14 (compatible)
4958 (135Eh)	4959 (135Fh)	Indirect reference area 15 (compatible)

Register address		Name
Upper	Lower	
4960 (1360h)	4961 (1361h)	Indirect reference area 16 (compatible)
4962 (1362h)	4963 (1363h)	Indirect reference area 17 (compatible)
4964 (1364h)	4965 (1365h)	Indirect reference area 18 (compatible)
4966 (1366h)	4967 (1367h)	Indirect reference area 19 (compatible)
4968 (1368h)	4969 (1369h)	Indirect reference area 20 (compatible)
4970 (136Ah)	4971 (136Bh)	Indirect reference area 21 (compatible)
4972 (136Ch)	4973 (136Dh)	Indirect reference area 22 (compatible)
4974 (136Eh)	4975 (136Fh)	Indirect reference area 23 (compatible)
4976 (1370h)	4977 (1371h)	Indirect reference area 24 (compatible)
4978 (1372h)	4979 (1373h)	Indirect reference area 25 (compatible)
4980 (1374h)	4981 (1375h)	Indirect reference area 26 (compatible)
4982 (1376h)	4983 (1377h)	Indirect reference area 27 (compatible)
4984 (1378h)	4985 (1379h)	Indirect reference area 28 (compatible)
4986 (137Ah)	4987 (137Bh)	Indirect reference area 29 (compatible)
4988 (137Ch)	4989 (137Dh)	Indirect reference area 30 (compatible)
4990 (137Eh)	4991 (137Fh)	Indirect reference area 31 (compatible)

■ Setting example

This section explains an example when sending/receiving data to/from the slave address 1 using indirect reference.

● STEP 1: Registration in indirect reference addresses

Setting data

Indirect reference address	Register address			Data to be sent	Setting value
	Upper	Lower			
Indirect reference address setting (0)	1536 (0600h)	1537 (0601h)	←	Direct data operation zero velocity command action	272 (0110h) (Value in NET-ID of Direct data operation zero velocity command action)
Indirect reference address setting (1)	1538 (0602h)	1539 (0603h)	←	Command filter time constant	298 (012Ah) (Value in NET-ID of Command filter time constant)
Indirect reference address setting (2)	1540 (0604h)	1541 (0605h)	←	MOVE minimum ON time	1802 (070Ah) (Value in NET-ID MOVE minimum ON time)

Send the following query to register the addresses of the sending data in indirect reference addresses.

Query

Field name		Data	Description
Slave address		01h	Slave address 1
Function code		10h	Writing to multiple holding registers
Data	Register address (upper)	06h	Register address to start writing from = Indirect reference address setting (0) (0600h)
	Register address (lower)	00h	
	Number of registers (upper)	00h	Number of registers to be written from the starting register address = 6 registers (0006h)
	Number of registers (lower)	06h	
	Number of data bytes	0Ch	Twice the number of registers in the query = 12
	Value write to register address (upper)	00h	Value written to register address 0600h = Direct data operation zero velocity command action (NET-ID: 0110h)
	Value write to register address (lower)	00h	
	Value write to register address +1 (upper)	01h	
	Value write to register address +1 (lower)	10h	Value written to register address 0602h = Command filter time constant (NET-ID: 012Ah)
	Value write to register address +2 (upper)	00h	
	Value write to register address +2 (lower)	00h	
	Value write to register address +3 (upper)	01h	
	Value write to register address +3 (lower)	2Ah	Value written to register address 0604h = MOVE minimum ON time (NET-ID: 070Ah)
	Value write to register address +4 (upper)	00h	
Value write to register address +4 (lower)	00h		
Value write to register address +5 (upper)	07h		
Value write to register address +5 (lower)	0Ah		
Error check (lower)		EFh	Calculation result of CRC-16
Error check (upper)		53h	

● STEP 2: Writing to indirect reference areas

Setting data

Indirect reference area	Register address			Data to be sent	Setting value
	Upper	Lower			
Indirect reference area 0	1792 (0700h)	1793 (0701h)	←	Direct data operation zero velocity command action	0 (0000h)
Indirect reference area 1	1794 (0702h)	1795 (0703h)	←	Command filter time constant	10 (000Ah)
Indirect reference area 2	1796 (0704h)	1797 (0705h)	←	MOVE minimum ON time	1 (0001h)

Send the following query to write the setting values of the sending data in indirect reference areas.

Query

Field name		Data	Description
Slave address		01h	Slave address 1
Function code		10h	Writing to multiple holding registers
Data	Register address (upper)	07h	Register address to start writing from = Indirect reference area 0 (0700h)
	Register address (lower)	00h	
	Number of registers (upper)	00h	Number of registers to be written from the starting register address = 6 registers (0006h)
	Number of registers (lower)	06h	
	Number of data bytes	0Ch	Twice the number of registers in the query = 12
	Value write to register address (upper)	00h	Value written to register address 0700h = Direct data operation zero velocity command action = 0 (0000h)
	Value write to register address (lower)	00h	
	Value write to register address +1 (upper)	00h	
	Value write to register address +1 (lower)	00h	
	Value write to register address +2 (upper)	00h	Value written to register address 0702h = Command filter time constant = 10 (000Ah)
	Value write to register address +2 (lower)	00h	
	Value write to register address +3 (upper)	00h	
	Value write to register address +3 (lower)	0Ah	
	Value write to register address +4 (upper)	00h	Value written to register address 0704h = MOVE minimum ON time = 1 (0001h)
Value write to register address +4 (lower)	00h		
Value write to register address +5 (upper)	00h		
Value write to register address +5 (lower)	01h		
Error check (lower)		E1h	Calculation result of CRC-16
Error check (upper)		27h	

● **STEP 3: Reading from indirect reference areas**

Send the following query to read the data written to indirect reference areas.

Query

Field name		Data	Description
Slave address		01h	Slave address 1
Function code		03h	Reading from holding registers
Data	Register address (upper)	07h	Register address to start reading from = Indirect reference area 0 (0700h)
	Register address (lower)	00h	
	Number of registers (upper)	00h	Number of registers to be read from the starting register address (6 registers = 0006h)
	Number of registers (lower)	06h	
Error check (lower)		C4h	Calculation result of CRC-16
Error check (upper)		BCh	

Response

Field name		Data	Description
Slave address		01h	Same as query
Function code		03h	Same as query
Data	Number of data bytes	0Ch	Twice the number of registers in the query = 12
	Value read from register address (upper)	00h	Value read from register address 0700h = 0 (0000h)
	Value read from register address (lower)	00h	
	Value read from register address +1 (upper)	00h	
	Value read from register address +1 (lower)	00h	
	Value read from register address +2 (upper)	00h	Value read from register address 0702h = 10 (000Ah)
	Value read from register address +2 (lower)	00h	
	Value read from register address +3 (upper)	00h	
	Value read from register address +3 (lower)	0Ah	Value read from register address 0704h = 1 (0001h)
	Value read from register address +4 (upper)	00h	
	Value read from register address +4 (lower)	00h	
	Value read from register address +5 (upper)	00h	
Value read from register address +5 (lower)	01h		
Error check (lower)		CAh	Calculation result of CRC-16
Error check (upper)		B1h	

It was found that the data had been written normally using indirect reference.

8 Group send

Multiple slaves are made into a group and a query is sent to all slaves in the group at once.

■ Group composition

A group consists of one parent slave and child slaves and only the parent slave returns a response.

■ Group address

To perform the group send, set a group address to the child slaves to be included in the group. The child slaves to which the group address has been set can receive a query sent to the parent slave.

The parent slave is not always required. A group can be composed by only child slaves. In this case, set an unused address as an address of the group.

When a query is sent from the master to the address of the group, the child slaves execute the process.

However, no response is returned. In broadcasting, all the slaves execute the process, however, the slaves that execute the process can be limited in this method.

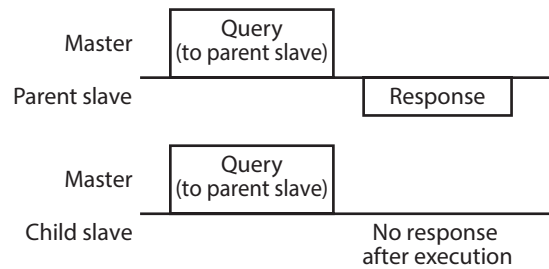

■ Parent slave

No special setting is required on the parent slave to perform the group send. The address of the parent slave becomes the group address. When a query is sent from the master to the parent slave, the parent slave executes the requested process and returns a response. (Same as the unicast mode)

■ Child slave

Slaves to which the address of the parent slave is set become the child slaves.

When a query sent to the address of the group is received, the child slaves execute the process. However, no response is returned.

The function code that can be executed in the group send is "Writing to multiple holding registers (10h)" only.

■ Setting of Group

Set the address of the parent slave to the "Group ID" of the child slaves. Change the group in the unicast mode. For reading and writing when setting the "Group ID," execute the upper and lower parameters at the same time.

● Related command

Register address		Name	Description	Initial setting	
Upper	Lower			Initial value	Unit
48 (0030h)	49 (0031h)	Group ID	Sets an address of the group. [Setting range] -1: No group specification (group send is not performed) 1 to 31: The address (address of the parent slave) of the group	-1	-

Note

- Do not set "0" to the group ID.
- Change the group address in the unicast mode.
- The group setting is stored in RAM, so the initial value is returned when the main power supply of the driver is turned off.
The initial value can be changed using the "Initial group ID (Modbus)" parameter.

● Related parameter

Register address		Parameter name	Description	Initial setting	
Upper	Lower			Initial value	Unit
5012 (1394h)	5013 (1395h)	Initial group ID (Modbus)	Sets the address of a group (address number of parent slave). [Setting range] -1: Disable (no group transmission) 1 to 31: Group ID ※ Do not use 0.	-1	-

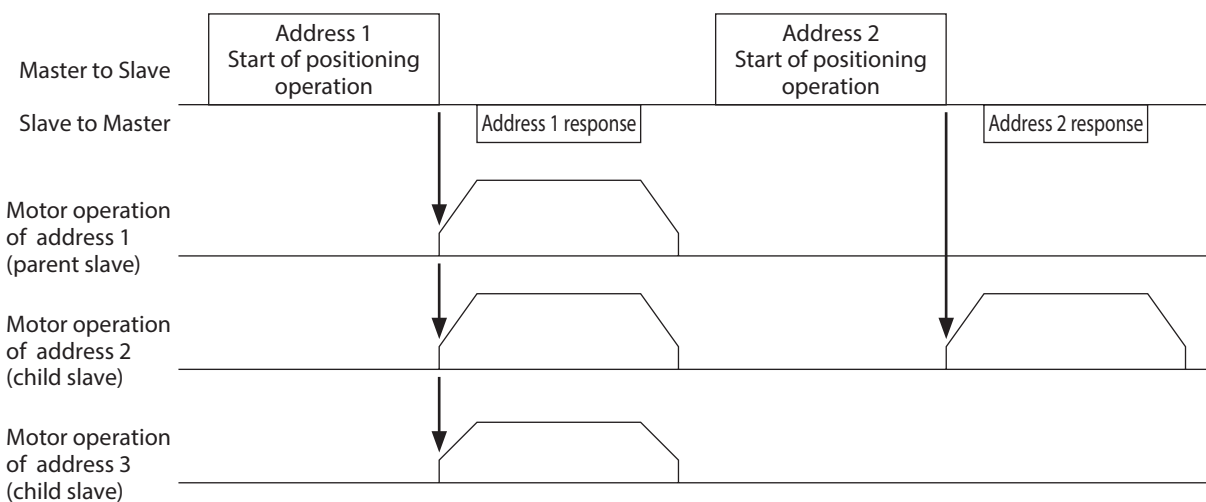
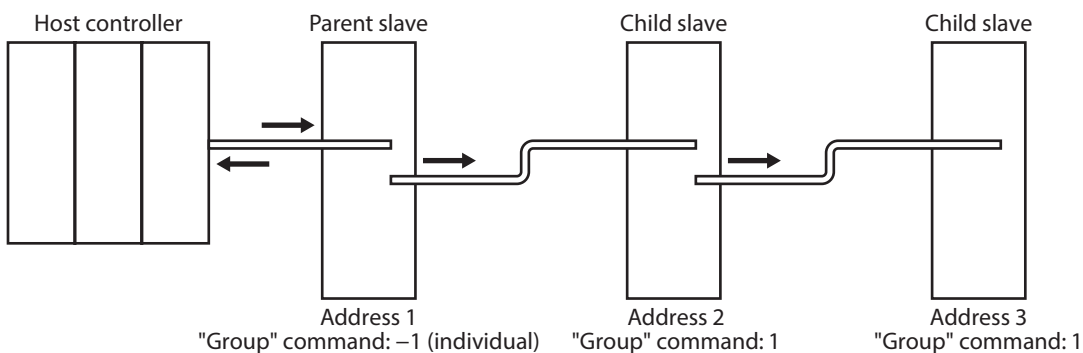

9 RS-485 communication monitor

This section indicates items that can be monitored via RS-485 communication. They can also be checked using the "RS-485 communication status monitor" of the support software.

Register address		Name	Description	Initial setting	
Upper	Lower			Initial value	Unit
172 (00ACh)	173 (00ADh)	Present communication error	Indicates the communication error code received last time.	–	–
340 (0154h)	341 (0155h)	RS-485 communication reception byte counter	Indicates the number of bytes received.	–	–
342 (0156h)	343 (0157h)	RS-485 communication transmission byte counter	Indicates the number of bytes transmitted.	–	–
344 (0158h)	345 (0159h)	RS-485 communication normal reception frame counter (All)	Indicates the number of normal frames received.	–	–
346 (015Ah)	347 (015Bh)	RS-485 communication normal reception frame counter (Only own address)	Indicates the number of normal frames received to own address.	–	–
348 (015Ch)	349 (015Dh)	RS-485 communication abnormal reception frame counter (All)	Indicates the number of abnormal frames received.	–	–
350 (015Eh)	351 (015Fh)	RS-485 communication transmission frame counter	Indicates the number of frames transmitted.	–	–
352 (0160h)	353 (0161h)	RS-485 communication register write error counter	Indicates the number of times the register write error occurred.	–	–
354 (0162h)	355 (0163h)	RS-485 communication valid frame/second	Indicates the number of valid frames per second.	–	–
356 (0164h)	357 (0165h)	RS-485 communication processing time	Indicates the communication processing time for RS-485 communication.	–	ms
358 (0166h)	359 (0167h)	RS-485 communication maximum processing time	Indicates the maximum communication processing time after turning on the power.	–	ms
360 (0168h)	361 (0169h)	RS-485 communication interval	Indicates the communication interval for RS-485 communication.	–	ms
362 (016Ah)	363 (016Bh)	RS-485 communication maximum interval	Indicates the maximum communication interval for RS-485 communication.	–	ms

10 Timing chart

10-1 Communication start

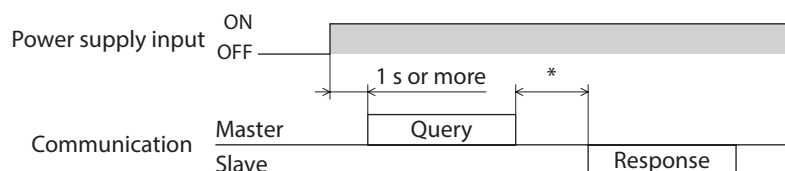

* $C3.5$ (silent interval) + Longer one from among $Tb5$ (query processing time (driver)) and $Tb2$ (transmission waiting time (driver side))

10-2 Operation start

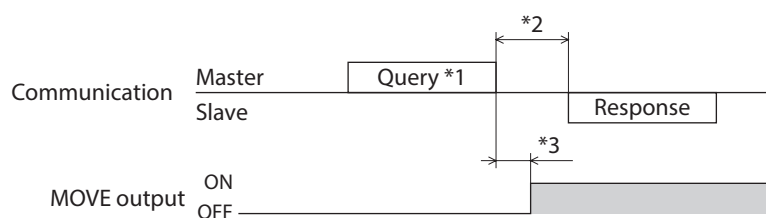

*1 A message including a query to start operation via RS-485 communication

*2 $C3.5$ (silent interval) + Longer one from among $Tb5$ (query processing time (driver)) and $Tb2$ (transmission waiting time (driver side))

*3 $C3.5$ (silent interval) + $Tb5$ (query processing time (driver)) + 2 ms or less

10-3 Operation stop, velocity change

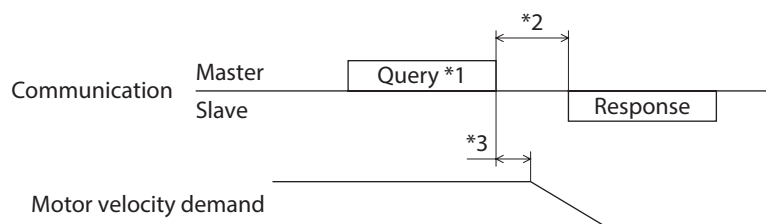

*1 A message including a query to stop operation and another to change the velocity via RS-485 communication

*2 $C3.5$ (silent interval) + Longer one from among $Tb5$ (query processing time (driver)) and $Tb2$ (transmission waiting time (driver side))

*3 $C3.5$ (silent interval) + $Tb5$ (query processing time (driver)) + 2 ms or less

10-4 General signal

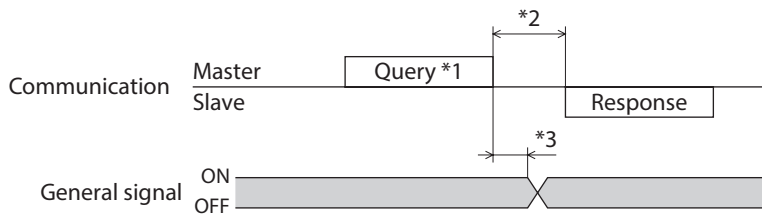

*1 A message including a query for remote output via RS-485 communication

*2 $C3.5$ (silent interval) + Longer one from among $Tb5$ (query processing time (driver)) and $Tb2$ (transmission waiting time (driver side))

*3 $C3.5$ (silent interval) + $Tb5$ (query processing time (driver)) + 2 ms or less

10-5 Configuration

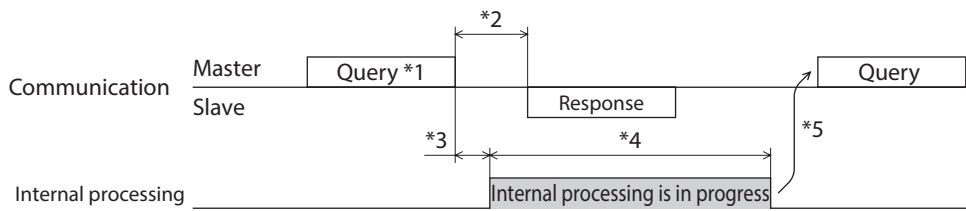

*1 A message including a query for configuration via RS-485 communication.

*2 $C3.5$ (silent interval) + Longer one from among $Tb5$ (query processing time (driver)) and $Tb2$ (transmission waiting time (driver side))

*3 $C3.5$ (silent interval) + $Tb5$ (query processing time (driver)) + 2 ms or less

*4 1 s or less

*5 Do not execute writing while configuration is executed.

11 Detection of communication errors

This is a function to detect abnormalities that may occur in RS-485 communication, including two types: communication errors and alarms.

11-1 Communication errors

If the communication error with error code 84h occurs, the COMM LED on the driver is lit in red. For communication errors other than 84h, the LED will not be lit or blink. The communication error can be checked using the "Communication error history" command via RS-485 communication or using the support software.

Note The communication error history is cleared when the main power supply of the driver is turned off because it is stored in RAM.

■ Communication error list

Type of communication error	Error code	Cause
RS-485 communication error	84h	A transmission error was detected. (Reference ⇨ p.226)
Command not yet defined	88h	An exception response (exception code 01h, 02h) was detected. (Reference ⇨ p.226)
Execution disable due to user I/F communication in progress	89h	An exception response (exception code 04h) was detected. (Reference ⇨ p.226)
Execution disable due to non-volatile memory processing in progress	8Ah	
Outside setting range	8Ch	An exception response (exception code 03h, 04h) was detected. (Reference ⇨ p.226)
Command execute disable	8Dh	An exception response (exception code 04h) was detected. (Reference ⇨ p.226)

11-2 Alarms related to RS-485 communication

If an alarm related to RS-485 communication is generated, the ALM-A output is turned ON and the ALM-B output is turned OFF to stop the motor. The PWR/SYS LED on the driver will blink in red.

■ Alarm list related to RS-485 communication

Alarm code	Alarm type	Cause
81h	Network bus error	When the "Communication power supply lost action" parameter is set to "Immediate stop with alarm," "Deceleration stop with alarm," "Follow QSTOP setting with alarm," or "Follow STOP setting with alarm," OFF (OFF edge) of the power supply for communication was detected.
84h	RS-485 communication error	The RS-485 communication error occurred consecutively by the number of times set in the "Communication error detection (Modbus)" parameter.
85h	RS-485 communication timeout	The time set in the "Communication timeout (Modbus)" parameter has elapsed, and yet the communication could not be established with the host controller.

11-3 Information related to RS-485 communication

If information related to RS-485 communication is generated, the motor will continue operating and the PWR/SYS LED on the driver will blink in blue.

■ RS-485 communication error information

If the RS-485 communication error occurs consecutively more than the number of times set in the "RS-485 communication error information (INFO-485-ERR)" parameter, information will be generated. When the communication is performed properly, the number of times that has counted is reset.

■ RS-485 communication processing time information

If the RS-485 communication processing time exceeds the time set in the "RS-485 communication processing time information (INFO-485-PRCST)" parameter, information will be generated.

■ RS-485 communication interval information

If the RS-485 communication interval exceeds the time set in the "RS-485 communication interval information (INFO-485-INTVL)" parameter, information will be generated..

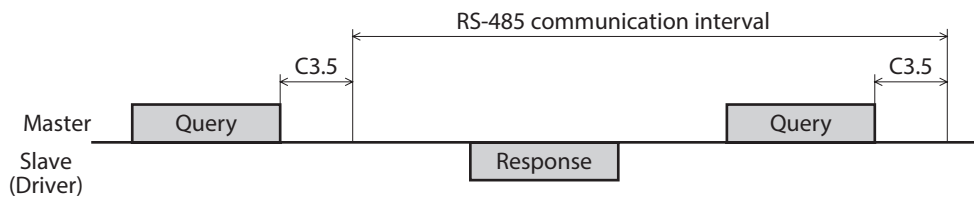

12 Modbus RTU ID share mode

12-1 Overview of Modbus RTU ID share mode

Sharing the communication ID (Share Control Global ID) with multiple slaves, the master can send a query to multiple slaves at once. The slave executes the process and returns a response sequentially. Synchronization between slaves is better than the unicast mode since a query can be sent to multiple slaves at the same time. The ID share mode is our unique transmission method.

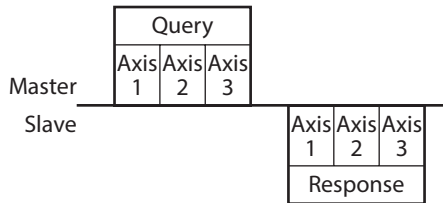

■ Example of operation

This section describes operation that a query is sent to two slaves using the ID share mode. To use the ID share mode, setting a share group is required first. A share group is a group of slaves that operates in the ID share mode. A share group is set by setting Share Control Global ID, Share Control Number, and Share Control Local ID. The settings of two slaves are as follows.

Command	Slave address 5	Slave address 7
Share Control Global ID	15 (0Fh)	15 (0Fh)
Share Control Number	2 (02h)	2 (02h)
Share Control Local ID	1 (01h)	2 (02h)

The address when a query is sent to the share group is the value of Share Control Global ID. In this case, Share Control Number is set to 2 in order to set two slaves to the share group. The master can send a query to the slave address 5 (Share Control Local ID=1) and the slave address 7 (Share Control Local ID=2) at once by sending a query to the share group address (Share Control Global ID=15). The master can also send a query to the slave address 5 and the slave address 7 separately.

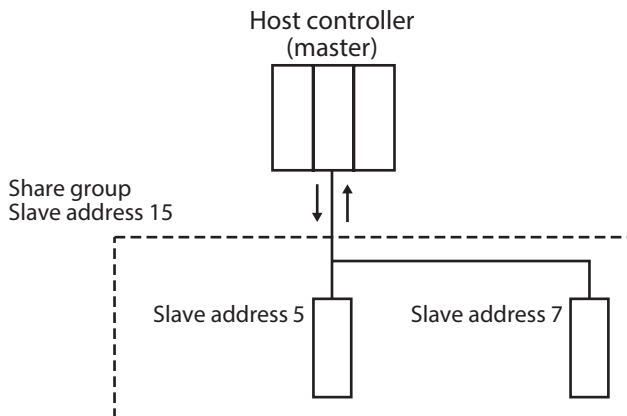

The motor operation when the master sent a command of continuous operation is as follows.

The master sends a query to the share group address (slave address 15), and the slave addresses 5 and 7 start continuous operation. Responses are sent in order, starting with Share Control Local ID=1. A query can be sent for each slave address. Therefore, the operation profile can be changed for each slave address.

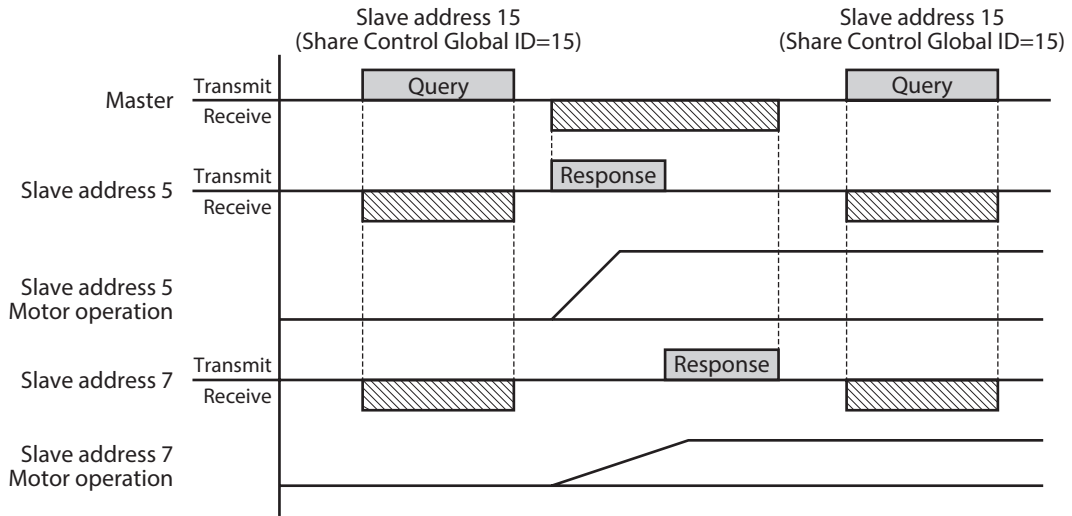

Even if a share group is set, communication can be performed in the unicast mode or the broadcast mode.

12-2 Function code

Function code	Function	Number of registers		Possible to use
		Each axis	Total for all axes	
03h	Reading from holding registers	1 to 24	1 to 125 *	Possible
06h	Writing to a holding register	–	–	Not possible
08h	Diagnosis	–	–	Not possible
10h	Writing to multiple holding registers	1 to 24	1 to 123	Possible
17h	Read/write of multiple holding registers	Read: 1 to 24 Write: 1 to 24	Read: 1 to 125 * Write: 1 to 121	Possible

* The maximum number of registers in total for all axes includes the error check between slaves.
Example: When used with six axes, the maximum value is 119 (125 – 6 = 119).

12-3 Guidance

If you are new to this product, read this section to understand the flow to read the data in the ID share mode. This example shows how to execute read of the present alarm, driver temperature, and motor temperature for two drivers using the host controller.

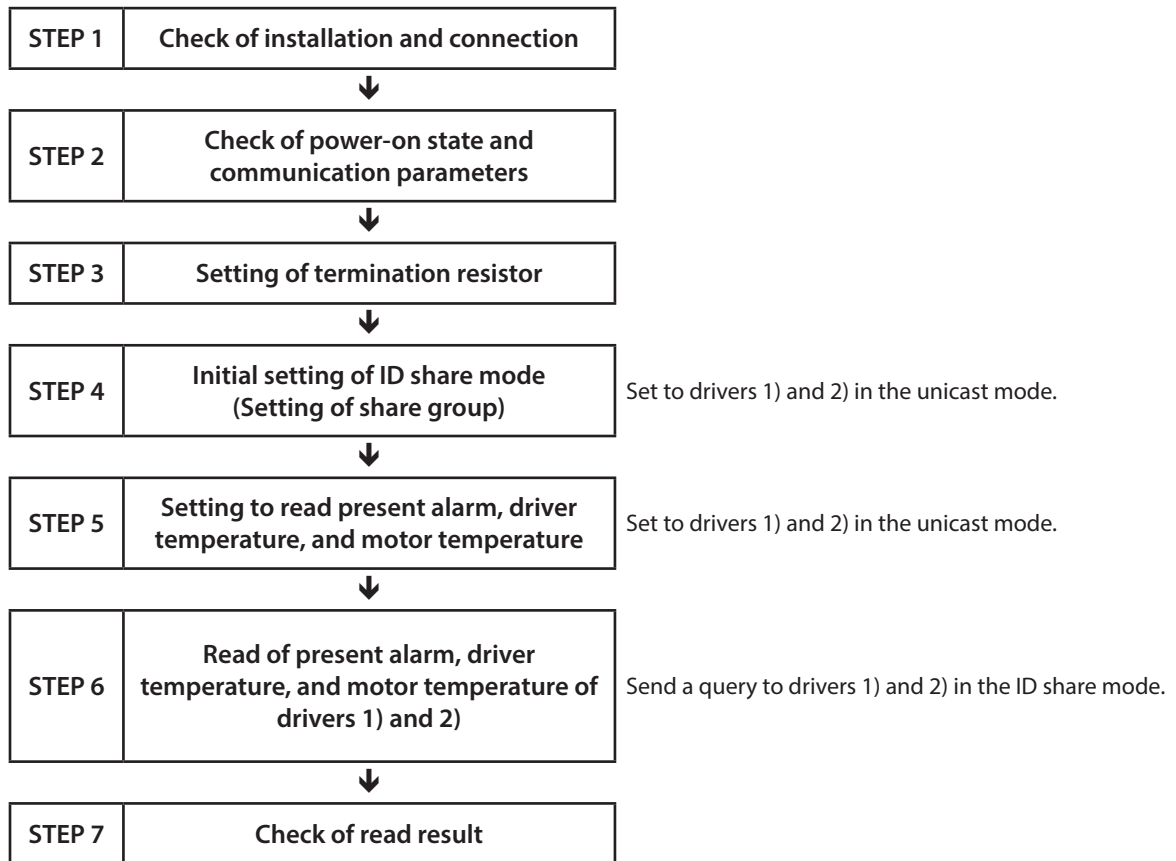

● **Operating conditions**

This operation is performed under the following conditions.

- Number of drivers connected: 2 units
- Address number: 1, 2
- Transmission rate: 230,400 bps
- Termination resistor: Set the communication ID=2 only

Note Before operating the motor, check the condition of the surrounding area to ensure safety.

● **Driver status**

The status of driver 1) and driver 2) is as follows.

Description	Driver 1)		Driver 2)	
	Value read	Corresponding decimal	Value read	Corresponding decimal
Present alarm (upper)	0000h	0	0000h	48
Present alarm (lower)	0000h		0030h	
Driver temperature (upper)	0000h	383	0000h	450
Driver temperature (lower)	017Fh		01C2h	
Motor temperature (upper)	0000h	426	0000h	538
Motor temperature (lower)	01AAh		021Ah	

memo STEP 4 and STEP 5 can also be set using the support software.

STEP 1 Check of installation and connection

■ Connection example

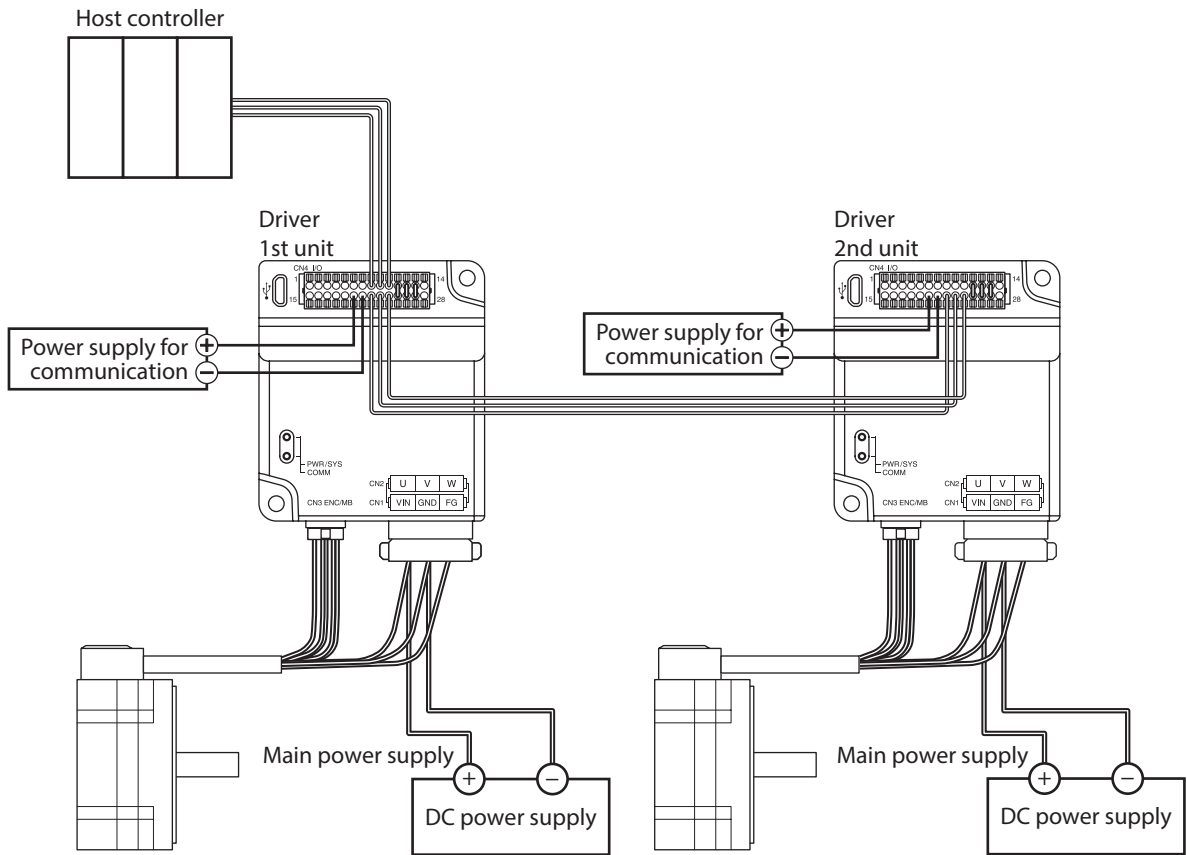

STEP 2 Check of power-on state and communication parameters

After turning on the main power supply of the driver, check the communication parameters listed below are the same values as the host controller using the support software.
 If the values are different, change the communication parameters of the driver.

Name	Setting	
	Driver 1)	Driver 2)
Slave address (Modbus)	ID=1	ID=2
Baudrate (Modbus)	230,400 bps	230,400 bps
Byte & word order (Modbus)	Even Address-High Word & Big-Endian	Even Address-High Word & Big-Endian
Communication parity (Modbus)	Even number	Even number
Communication stop bit (Modbus)	1 bit	1 bit
Transmission waiting time (Modbus)	30 (3.0ms)	30 (3.0ms)
Silent interval (Modbus)	0 (Automatic)	0 (Automatic)

STEP 3 Setting of termination resistor

Set the "RS-485 communication termination resistor" parameter to "Enable" with the support software.

Name	Setting	
	Driver 1)	Driver 2)
RS-485 communication termination resistor	Disable	Enable

STEP 4 Initial setting of ID share mode

Send the following query to perform the initial setting of the ID share mode for drivers 1) and 2). (Unicast mode)

1. Set Share Control Global ID, Share Control Number, and Share Control Local ID to driver 1) with the following query.

Communication data (HEX)	Description
<u>01 10 09 80 00 06 0C 00 00 00 0F 00 00 00 02 00 00 00 01 44 D5</u>	Share Control Global ID=15 (0Fh) Share Control Number=2 (02h) Share Control Local ID=1 (01h)

2. Set Share Control Global ID, Share Control Number, and Share Control Local ID to driver 2) with the following query.

Communication data (HEX)	Description
<u>02 10 09 80 00 06 0C 00 00 00 0F 00 00 00 02 00 00 00 02 40 90</u>	Share Control Global ID=15 (0Fh) Share Control Number=2 (02h) Share Control Local ID=2 (02h)



The initial setting of ID share mode can also be set using the support software.

STEP 5 Setting to read present alarm, driver temperature, and motor temperature

Send the following query to set NET-ID of the data to be read in the ID share mode to drivers 1) and 2). (Unicast mode)

1. Set NET-ID of the present alarm, driver temperature, and motor temperature to the Share Read data 0 to 2 of driver 1) with the following query.

Communication data (HEX)	Description
<u>01 10 09 90 00 06 0C 00 00 00 40 00 00 00 7C 00 00 00 7D 10 C1</u>	Share Read data 0=64 (40h): Present alarm Share Read data 1=124 (7Ch): Driver temperature Share Read data 2=125 (7Dh): Motor temperature

2. Set NET-ID of the present alarm, driver temperature, and motor temperature to the Share Read data 0 to 2 of driver 2) with the following query.

Communication data (HEX)	Description
<u>02 10 09 90 00 06 0C 00 00 00 40 00 00 00 7C 00 00 00 7D 54 85</u>	Share Read data 0=64 (40h): Present alarm Share Read data 1=124 (7Ch): Driver temperature Share Read data 2=125 (7Dh): Motor temperature

 In this guidance, the same data is set to the Share Read data 0 to 2 of drivers 1) and 2), but different data can be set to each driver. Data can also be set using the support software.

STEP 6 Read of present alarm, driver temperature, and motor temperature of drivers 1) and 2)

Send the following query to read the data from drivers 1) and 2). (ID share mode)

0F 03 00 00 00 0E C5 20
① ② ③ ④ ⑤ ⑥

Number	Communication data (HEX)	Description
①	0F	Address number=15
②	03	Function code=03h
③	00 00	Head of ID share register address to be read (Share Read data 0)=0000h
④	00 0E	Number of registers to be read=14 registers *
⑤	C5	Error check (lower)
⑥	20	Error check (upper)

* Number of registers = (number of ID share register addresses to be read + 1) × Share Control Number = (6 + 1) × 2 = 14

 Set so that the number of registers to be read should be 26 × Share Control Number or less.

STEP 7 Check of read result

Check the read result.

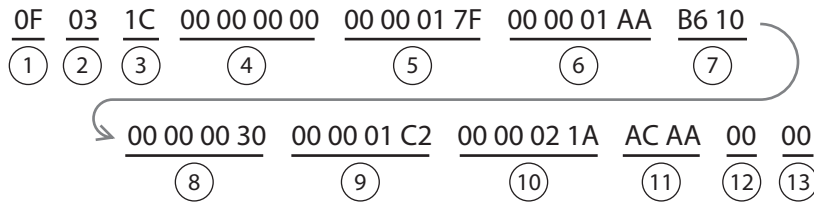

Number	Communication data (HEX)	Description
①	0F	Address number=15
②	03	Read function code=03h
③	1C	Twice the number of registers in the query
④	00 00 00 00	Value read from driver 1) Share Read data 0 (Present alarm)
⑤	00 00 01 7F	Value read from driver 1) Share Read data 1 (Driver temperature)
⑥	00 00 01 AA	Value read from driver 1) Share Read data 2 (Motor temperature)
⑦	B6 10	Error check for between slaves (indefinite value)
⑧	00 00 00 30	Value read from driver 2) Share Read data 0 (Present alarm)
⑨	00 00 01 C2	Value read from driver 2) Share Read data 1 (Driver temperature)
⑩	00 00 02 1A	Value read from driver 2) Share Read data 2 (Motor temperature)
⑪	AC AA	Error check for between slaves (indefinite value)
⑫	00	Error check (lower)
⑬	00	Error check (upper)

STEP 8 Did the system communicate properly?

If the communication could not performed properly, check the following points.

- Are the main power supply, the power supply for communication, and the RS-485 communication cable connected securely?
- Are the slave addresses, the transmission rate, and the termination resistor set correctly?
- Is the COMM LED lit in red? (A communication error occurs)

12-4 Flow of setting of ID share mode

This section describes the setting flow when the ID share mode is used. To use the ID share mode, setting a share group is required first. This is an operation example when a share group is set as follows.

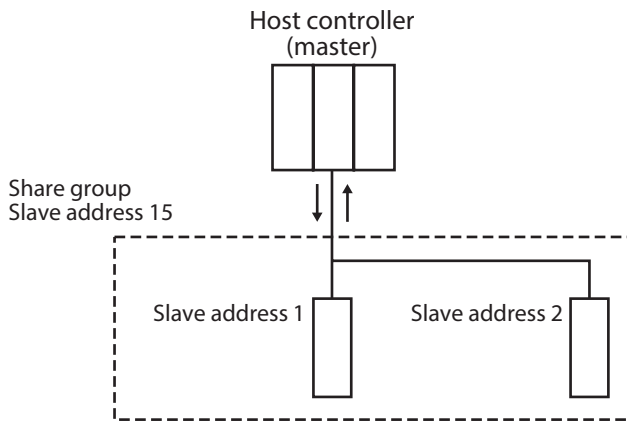

Command/parameter	Slave address 1	Slave address 2
Slave address (Modbus)	ID=1	ID=2
Share Control Global ID	15 (0Fh)	15 (0Fh)
Share Control Number	2 (02h)	2 (02h)
Share Control Local ID	1 (01h)	2 (02h)
Share Read data 0	Present alarm	Present alarm
Share Read data 1	Driver temperature	Driver temperature
Share Read data 2	Motor temperature	Motor temperature
Share Write data 0	Direct data operation operating velocity	Direct data operation operating velocity
Share Write data 1	Direct data operation acceleration rate	Direct data operation acceleration rate
Share Write data 2	Direct data operation deceleration rate	Direct data operation deceleration rate

■ STEP 1: Initial setting of ID share mode

First, perform the initial setting of the ID share mode. In the initial setting of the ID share mode, set a share group. Set Share Control Global ID, Share Control Number, and Share Control Local ID for each slave address.

■ STEP 2: Setting of data to be read and written

Next, set the data to be read or that to be written. For the data to be read, set NET-ID to the Modbus register address of Share Read data. For the data to be written, set NET-ID to the Modbus register address of Share Write data.

■ STEP 3: Read/write in ID share mode

Use the ID share mode to read/write from/to each slave.

12-5 Initial setting of ID share mode

Before using the ID share mode, create a group of slaves that operates in the ID share mode.

A group that operates in the ID share mode is called a share group.

To set a share group, set Share Control Global ID, Share Control Number, and Share Control Local ID for each slave address.

■ Setting example of share group

Set the following data to "Share Control Global ID," "Share Control Number," and "Share Control Local ID" of the slave address 1.

To set a share group, use the function code of writing to multiple holding registers (10h).

Also, to set a share group, send a query in the unicast mode.

This example explains using the slave address 1 only. Set to the slave address 2 in the same way.

Description	Register address	Slave address 1		Slave address 2	
		Value write	Corresponding decimal	Value write	Corresponding decimal
Share Control Global ID (upper)	2432 (0980h)	0000h	15	0000h	15
Share Control Global ID (lower)	2433 (0981h)	000Fh		000Fh	
Share Control Number (upper)	2434 (0982h)	0000h	2	0000h	2
Share Control Number (lower)	2435 (0983h)	0002h		0002h	
Share Control Local ID (upper)	2436 (0984h)	0000h	1	0000h	2
Share Control Local ID (lower)	2437 (0985h)	0001h		0002h	

Note Set one by one in order from "1" in the Share Control Local ID.

Query (unicast mode)

Field name	Data	Description
Slave address	01h	Slave address 1
Function code	10h	Writing to multiple holding registers
Data	Register address (upper)	09h
	Register address (lower)	80h
	Number of registers (upper)	00h
	Number of registers (lower)	06h
	Number of data bytes	0Ch
	Value write to register address (upper)	00h
	Value write to register address (lower)	00h
	Value write to register address +1 (upper)	00h
	Value write to register address +1 (lower)	0Fh
	Value write to register address +2 (upper)	00h
	Value write to register address +2 (lower)	00h
	Value write to register address +3 (upper)	00h
	Value write to register address +3 (lower)	02h
	Value write to register address +4 (upper)	00h
	Value write to register address +4 (lower)	00h
	Value write to register address +5 (upper)	00h
Value write to register address +5 (lower)	01h	
Error check (lower)	44h	
Error check (upper)	D5h	

Response (unicast mode)

Field name		Data	Description
Slave address		01h	Same as query
Function code		10h	Same as query
Data	Register address (upper)	09h	Same as query
	Register address (lower)	80h	
	Number of registers (upper)	00h	Same as query
	Number of registers (lower)	06h	
Error check (lower)		42h	Calculation result of CRC-16
Error check (upper)		7Fh	

Send a query to set a share group for the slave address 2 in the same way.

12-6 Setting of data to be read or written

Next, set the data to be read or that to be written.

For the data to be read, set NET-ID to the Modbus register address of Share Read data.

For the data to be written, set NET-ID to the Modbus register address of Share Write data.

■ Setting example of data to be read

For the slave address 1, set "Present alarm" in the "Share Read data 0," "Driver temperature" in the "Share Read data 1," and "Motor temperature" in the "Share Read data 2."

To set Share Read data, use the function code of writing to multiple holding registers (10h).

Send a query in the unicast mode for these settings.

A value written to the register address of Share Read data is NET-ID.

Refer to p.285 for NET-ID that can be set to Share Read data.

In this example, the same NET-ID is set to the Share Read data 0 to 2 of the slave addresses 1 and 2, but different NET-ID can also be set to the slave address 1 and the slave address 2, respectively.

This example explains using slave address 1 only. Set to the slave address 2 in the same way.

Description	Register address	Setting item to be read	Slave address 1		Slave address 2	
			NET-ID Value write	Corresponding decimal	NET-ID Value write	Corresponding decimal
Share Read data 0 (upper)	2448 (0990h)	Present alarm	0000h	64	0000h	64
Share Read data 0 (lower)	2449 (0991h)		0040h		0040h	
Share Read data 1 (upper)	2450 (0992h)	Driver temperature	0000h	124	0000h	124
Share Read data 1 (lower)	2451 (0993h)		007Ch		007Ch	
Share Read data 2 (upper)	2452 (0994h)	Motor temperature	0000h	125	0000h	125
Share Read data 2 (lower)	2453 (0995h)		007Dh		007Dh	

Query (unicast mode)

Field name	Data	Description	
Slave address	01h	Slave address 1	
Function code	10h	Writing to multiple holding registers	
Data	Register address (upper)	09h	
	Register address (lower)	90h	Register address to start writing from
	Number of registers (upper)	00h	Number of registers to be written from the starting register address (6 registers=0006h)
	Number of registers (lower)	06h	
	Number of data bytes	0Ch	Twice the number of registers in the query
	Value write to register address (upper)	00h	Value written to register address 0990h
	Value write to register address (lower)	00h	
	Value write to register address +1 (upper)	00h	Value written to register address 0991h
	Value write to register address +1 (lower)	40h	
	Value write to register address +2 (upper)	00h	Value written to register address 0992h
	Value write to register address +2 (lower)	00h	
	Value write to register address +3 (upper)	00h	Value written to register address 0993h
	Value write to register address +3 (lower)	7Ch	
	Value write to register address +4 (upper)	00h	Value written to register address 0994h
	Value write to register address +4 (lower)	00h	
	Value write to register address +5 (upper)	00h	Value written to register address 0995h
Value write to register address +5 (lower)	7Dh		
Error check (lower)	10h	Calculation result of CRC-16	
Error check (upper)	C1h		

Response (unicast mode)

Field name	Data	Description	
Slave address	01h	Same as query	
Function code	10h	Same as query	
Data	Register address (upper)	09h	
	Register address (lower)	90h	Same as query
	Number of registers (upper)	00h	Same as query
	Number of registers (lower)	06h	
Error check (lower)	43h	Calculation result of CRC-16	
Error check (upper)	BAh		

Send a query to set the read data for the slave address 2 in the same way.

■ Setting example of data to be written

For the slave address 1, set "Direct data operation operating velocity" in the "Share Write data 0," "Direct data operation acceleration rate" in the "Share Write data 1," and "Direct data operation deceleration rate" in the "Share Write data 2."

To set Share Write data, use the function code of writing to multiple holding registers (10h).

Send a query in the unicast mode for these settings.

A value written to the register address of Share Write data is NET-ID.

Refer to p.285 for NET-ID that can be set to Share Write data.

In this example, the same NET-ID is set to the Share Write data 0 to 2 of the slave addresses 1 and 2, but different NET-ID can also be set to the slave address 1 and the slave address 2, respectively.

This example explains using slave address 1 only. Set to the slave address 2 in the same way.

Description	Register address	Setting item to be written	Slave address 1		Slave address 2	
			NET-ID Value write	Corresponding decimal	NET-ID Value write	Corresponding decimal
Share Write data 0 (upper)	2472 (09A8h)	Direct data operation operating velocity	0000h	47	0000h	47
Share Write data 0 (lower)	2473 (09A9h)		002Fh		002Fh	
Share Write data 1 (upper)	2474 (09AAh)	Direct data operation acceleration rate	0000h	48	0000h	48
Share Write data 1 (lower)	2475 (09ABh)		0030h		0030h	
Share Write data 2 (upper)	2476 (09ACh)	Direct data operation deceleration rate	0000h	49	0000h	49
Share Write data 2 (lower)	2477 (09ADh)		0031h		0031h	

Query (unicast mode)

Field name	Data	Description
Slave address	01h	Slave address 1
Function code	10h	Writing to multiple holding registers
Data	Register address (upper)	09h
	Register address (lower)	A8h
	Number of registers (upper)	00h
	Number of registers (lower)	06h
	Number of data bytes	0Ch
	Value write to register address (upper)	00h
	Value write to register address (lower)	00h
	Value write to register address +1 (upper)	00h
	Value write to register address +1 (lower)	2Fh
	Value write to register address +2 (upper)	00h
	Value write to register address +2 (lower)	00h
	Value write to register address +3 (upper)	00h
	Value write to register address +3 (lower)	30h
	Value write to register address +4 (upper)	00h
Value write to register address +4 (lower)	00h	
Value write to register address +5 (upper)	00h	
Value write to register address +5 (lower)	31h	
Error check (lower)	FAh	
Error check (upper)	DAh	

Response (unicast mode)

Field name	Data	Description
Slave address	01h	Same as query
Function code	10h	Same as query
Data	Register address (upper)	09h
	Register address (lower)	A8h
	Number of registers (upper)	00h
	Number of registers (lower)	06h
Error check (lower)	C2h	Calculation result of CRC-16
Error check (upper)	77h	

Send a query to set the write data for the slave address 2 in the same way.

12-7 Read/write in ID share mode

Use the ID share mode to read/write from/to each slave.

■ Read using ID share mode

To read in the ID share mode, use the function code of reading from a holding register(s) (03h) to read a value (16 bits) of Share Read data. Up to 24 successive registers (24 × 16 bits) can be read.

The relation between the ID share register address and Share Read data is shown in the table below.

ID share register address	Corresponding Share Read data	ID share register address	Corresponding Share Read data
0 (0000h)	Share Read data 0 (upper)	12 (000Ch)	Share Read data 6 (upper)
1 (0001h)	Share Read data 0 (lower)	13 (000Dh)	Share Read data 6 (lower)
2 (0002h)	Share Read data 1 (upper)	14 (000Eh)	Share Read data 7 (upper)
3 (0003h)	Share Read data 1 (lower)	15 (000Fh)	Share Read data 7 (lower)
4 (0004h)	Share Read data 2 (upper)	16 (0010h)	Share Read data 8 (upper)
5 (0005h)	Share Read data 2 (lower)	17 (0011h)	Share Read data 8 (lower)
6 (0006h)	Share Read data 3 (upper)	18 (0012h)	Share Read data 9 (upper)
7 (0007h)	Share Read data 3 (lower)	19 (0013h)	Share Read data 9 (lower)
8 (0008h)	Share Read data 4 (upper)	20 (0014h)	Share Read data 10 (upper)
9 (0009h)	Share Read data 4 (lower)	21 (0015h)	Share Read data 10 (lower)
10 (000Ah)	Share Read data 5 (upper)	22 (0016h)	Share Read data 11 (upper)
11 (000Bh)	Share Read data 5 (lower)	23 (0017h)	Share Read data 11 (lower)

Read the upper and lower data at the same time. If they are not read at the same time, the value may be invalid. When multiple holding registers are read, they are read in order of ID share register addresses.

● **Example of read**

Read "Present alarm," "Driver temperature" and "Motor temperature" of the slave address 1.
 Read "Present alarm," "Driver temperature" and "Motor temperature" of the slave address 2.

Description	ID share register address	Slave address 1		Slave address 2	
		Value read	Corresponding decimal	Value read	Corresponding decimal
Present alarm (upper)	0 (0000h): Share Read data 0 (upper)	0000h	0	0000h	48
Present alarm (lower)	1 (0001h): Share Read data 0 (lower)	0000h		0030h	
Driver temperature (upper)	2 (0002h): Share Read data 1 (upper)	0000h	383	0000h	450
Driver temperature (lower)	3 (0003h): Share Read data 1 (lower)	017Fh		01C2h	
Motor temperature (upper)	4 (0004h): Share Read data 2 (upper)	0000h	426	0000h	538
Motor temperature (lower)	5 (0005h): Share Read data 2 (lower)	01AAh		021Ah	

Query (ID share mode)

Field name		Data	Description
Slave address		0Fh	Slave address 15
Function code		03h	Reading from holding registers
Data	ID share register address (upper)	00h	ID share register address to start reading from (Share Read data 0 (upper))
	ID share register address (lower)	00h	
	Number of registers (upper)	00h	Number of registers to be read from the starting ID share register address (14 registers=000Eh) *
	Number of registers (lower)	0Eh	
Error check (lower)		C5h	Calculation result of CRC-16
Error check (upper)		20h	

* Number of registers = (number of ID share register addresses to be read + 1) × Share Control Number

Note Set so that the number of registers to be read should be 26 × Share Control Number or less.

Response (ID share mode)

Field name		Data	Description	
Slave address		0Fh	Same as query	
Function code		03h	Same as query	
Data	Number of data bytes		1Ch Twice the number of registers in the query	
	Share Control Local ID 1	Value read from ID share register address (upper)	00h	Value read from Share Read data 0 (upper)
		Value read from ID share register address (lower)	00h	
		Value read from ID share register address +1 (upper)	00h	Value read from Share Read data 0 (lower)
		Value read from ID share register address +1 (lower)	00h	
		Value read from ID share register address +2 (upper)	00h	Value read from Share Read data 1 (upper)
		Value read from ID share register address +2 (lower)	00h	
		Value read from ID share register address +3 (upper)	01h	Value read from Share Read data 1 (lower)
		Value read from ID share register address +3 (lower)	7Fh	
		Value read from ID share register address +4 (upper)	00h	Value read from Share Read data 2 (upper)
		Value read from ID share register address +4 (lower)	00h	
		Value read from ID share register address +5 (upper)	01h	Value read from Share Read data 2 (lower)
		Value read from ID share register address +5 (lower)	AAh	
		Error check for between slaves (lower)	B6h	The error check value for between slaves is indefinite.
		Error check for between slaves (upper)	10h	
	Share Control Local ID 2	Value read from ID share register address (upper)	00h	Value read from Share Read data 0 (upper)
		Value read from ID share register address (lower)	00h	
		Value read from ID share register address +1 (upper)	00h	Value read from Share Read data 0 (lower)
		Value read from ID share register address +1 (lower)	30h	
		Value read from ID share register address +2 (upper)	00h	Value read from Share Read data 1 (upper)
		Value read from ID share register address +2 (lower)	00h	
		Value read from ID share register address +3 (upper)	01h	Value read from Share Read data 1 (lower)
		Value read from ID share register address +3 (lower)	C2h	
		Value read from ID share register address +4 (upper)	00h	Value read from Share Read data 2 (upper)
		Value read from ID share register address +4 (lower)	00h	
		Value read from ID share register address +5 (upper)	02h	Value read from Share Read data 2 (lower)
		Value read from ID share register address +5 (lower)	1Ah	
		Error check for between slaves (lower)	ACH	The error check value for between slaves is indefinite.
		Error check for between slaves (upper)	AAh	
	Error check (lower)		00h	Calculation result of CRC-16
Error check (upper)		00h		

■ **Write using ID share mode**

To write in the ID share mode, use the function code of writing to multiple holding registers (10h) to write a value (16 bits) of Share Write data. Up to 24 registers can be written.

The relation between the ID share register address and Share Write data is shown in the table below.

ID share register address	Corresponding Share Write data	ID share register address	Corresponding Share Write data
0 (0000h)	Share Write data 0 (upper)	12 (000Ch)	Share Write data 6 (upper)
1 (0001h)	Share Write data 0 (lower)	13 (000Dh)	Share Write data 6 (lower)
2 (0002h)	Share Write data 1 (upper)	14 (000Eh)	Share Write data 7 (upper)
3 (0003h)	Share Write data 1 (lower)	15 (000Fh)	Share Write data 7 (lower)
4 (0004h)	Share Write data 2 (upper)	16 (0010h)	Share Write data 8 (upper)
5 (0005h)	Share Write data 2 (lower)	17 (0011h)	Share Write data 8 (lower)
6 (0006h)	Share Write data 3 (upper)	18 (0012h)	Share Write data 9 (upper)
7 (0007h)	Share Write data 3 (lower)	19 (0013h)	Share Write data 9 (lower)
8 (0008h)	Share Write data 4 (upper)	20 (0014h)	Share Write data 10 (upper)
9 (0009h)	Share Write data 4 (lower)	21 (0015h)	Share Write data 10 (lower)
10 (000Ah)	Share Write data 5 (upper)	22 (0016h)	Share Write data 11 (upper)
11 (000Bh)	Share Write data 5 (lower)	23 (0017h)	Share Write data 11 (lower)

Write the data to the upper and lower at the same time. If not, an invalid value may be written. Data is written in order of ID share register addresses. Note that even when an exception response is returned because some data is invalid as being outside the specified range, etc., other data may have been written properly.

● **Example of write**

Write the following data to "Direct data operation operating velocity," "Direct data operation acceleration rate," and "Direct data operation deceleration rate" of the slave addresses 1 and 2.

Description	ID share register address	Slave address 1		Slave address 2	
		Value write	Corresponding decimal	Value write	Corresponding decimal
Direct data operation operating velocity (upper)	0 (0000h): Share Write data 0 (upper)	0000h	1,000	0000h	2,000
Direct data operation operating velocity (lower)	1 (0001h): Share Write data 0 (lower)	03E8h		07D0h	
Direct data operation acceleration rate (upper)	2 (0002h): Share Write data 1 (upper)	0000h	1,000	0000h	2,000
Direct data operation acceleration rate (lower)	3 (0003h): Share Write data 1 (lower)	03E8h		07D0h	
Direct data operation deceleration rate (upper)	4 (0004h): Share Write data 2 (upper)	0000h	2,000	0000h	5,000
Direct data operation deceleration rate (lower)	5 (0005h): Share Write data 2 (lower)	07D0h		1388h	

Query (ID share mode)

Field name		Data	Description	
Slave address		0Fh	Slave address 15	
Function code		10h	Writing to multiple holding registers	
Data	ID share register address (upper)	00h	ID share register address to start writing from (Share Write data 0 (upper))	
	ID share register address (lower)	00h		
	Number of registers (upper)	00h	Number of registers to be written from the starting ID share register address (12 registers=000Ch) *	
	Number of registers (lower)	0Ch		
	Number of data bytes		18h	Twice the number of registers in the query
	Share Control Local ID 1	Value write to ID share register address (upper)	00h	Value written to ID share register address 0000h
		Value write to ID share register address (lower)	00h	
		Value write to ID share register address +1 (upper)	03h	Value written to ID share register address 0001h
		Value write to ID share register address +1 (lower)	E8h	
		Value write to ID share register address +2 (upper)	00h	Value written to ID share register address 0002h
		Value write to ID share register address +2 (lower)	00h	
		Value write to ID share register address +3 (upper)	03h	Value written to ID share register address 0003h
		Value write to ID share register address +3 (lower)	E8h	
		Value write to ID share register address +4 (upper)	00h	Value written to ID share register address 0004h
		Value write to ID share register address +4 (lower)	00h	
		Value write to ID share register address +5 (upper)	07h	Value written to ID share register address 0005h
		Value write to ID share register address +5 (lower)	D0h	
	Share Control Local ID 2	Value write to ID share register address (upper)	00h	Value written to ID share register address 0000h
		Value write to ID share register address (lower)	00h	
		Value write to ID share register address +1 (upper)	07h	Value written to ID share register address 0001h
		Value write to ID share register address +1 (lower)	D0h	
		Value write to ID share register address +2 (upper)	00h	Value written to ID share register address 0002h
		Value write to ID share register address +2 (lower)	00h	
Value write to ID share register address +3 (upper)		07h	Value written to ID share register address 0003h	
Value write to ID share register address +3 (lower)		D0h		
Value write to ID share register address +4 (upper)		00h	Value written to ID share register address 0004h	
Value write to ID share register address +4 (lower)		00h		
Value write to ID share register address +5 (upper)		13h	Value written to ID share register address 0005h	
Value write to ID share register address +5 (lower)	88h			
Error check (lower)		99h	Calculation result of CRC-16	
Error check (upper)		21h		

* Number of registers = (Share Control Number) × Number of ID share register addresses to be written

Response (ID share mode)

Field name		Data	Description
Slave address		0Fh	Same as query
Function code		10h	Same as query
Data	ID share register address (upper)	00h	Same as query
	ID share register address (lower)	00h	
	Number of registers (upper)	00h	Same as query
	Number of registers (lower)	0Ch	
Error check (lower)		C1h	Calculation result of CRC-16
Error check (upper)		22h	

■ Read/write using ID share mode

To read and write in the ID share mode, use the function code of read/write of multiple holding registers (17h). With this function code, reading data of Share Read data and writing data of Share Write data can be performed. Data is written first, and then data is read.

● Read

Read the value (16 bits) of Share Read data. Up to 24 successive registers (24 × 16 bits) can be read. The relation between the ID share register address and Share Read data is the same as "Reading from a holding register(s) (03h)." Read the upper and lower data at the same time. If they are not read at the same time, the value may be invalid. When multiple holding registers are read, they are read in order of ID share register addresses.

● Write

Write the data to the value (16 bits) of Share Write data. Up to 24 registers can be written.

The relation between the ID share register address and Share Write data is the same as "Writing to multiple holding registers (10h)."

Write the data to the upper and lower at the same time. If not, an invalid value may be written. Data is written in order of ID share register addresses. Note that even when an exception response is returned because some data is invalid as being outside the specified range, etc., other data may have been written properly.

● Example of read/write

Read "Present alarm," "Driver temperature" and "Motor temperature" of the slave address 1.

Read "Present alarm," "Driver temperature" and "Motor temperature" of the slave address 2.

Description	ID share register address	Slave address 1		Slave address 2	
		Value read	Corresponding decimal	Value read	Corresponding decimal
Present alarm (upper)	0 (0000h): Share Read data 0 (upper)	0000h	0	0000h	48
Present alarm (lower)	1 (0001h): Share Read data 0 (lower)	0000h		0030h	
Driver temperature (upper)	2 (0002h): Share Read data 1 (upper)	0000h	383	0000h	450
Driver temperature (lower)	3 (0003h): Share Read data 1 (lower)	017Fh		01C2h	
Motor temperature (upper)	4 (0004h): Share Read data 2 (upper)	0000h	426	0000h	538
Motor temperature (lower)	5 (0005h): Share Read data 2 (lower)	01AAh		021Ah	

Write to the "Direct data operation operating velocity," "Direct data operation acceleration rate," and "Direct data operation deceleration rate" of the slave addresses 1 and 2.

Description	ID share register address	Slave address 1		Slave address 2	
		Value write	Corresponding decimal	Value write	Corresponding decimal
Direct data operation operating velocity (upper)	0 (0000h): Share Write data 0 (upper)	0000h	1,000	0000h	2,000
Direct data operation operating velocity (lower)	1 (0001h): Share Write data 0 (lower)	03E8h		07D0h	
Direct data operation acceleration rate (upper)	2 (0002h): Share Write data 1 (upper)	0000h	1,000	0000h	2,000
Direct data operation acceleration rate (lower)	3 (0003h): Share Write data 1 (lower)	03E8h		07D0h	
Direct data operation deceleration rate (upper)	4 (0004h): Share Write data 2 (upper)	0000h	2,000	0000h	5,000
Direct data operation deceleration rate (lower)	5 (0005h): Share Write data 2 (lower)	07D0h		1388h	

Query (ID share mode)

Field name		Data	Description	
Slave address		0Fh	Slave address 15	
Function code		17h	Read/write of multiple holding registers	
Data	(Read) ID share register address (upper)	00h	ID share register address to start reading from (Share Read data 0 (upper))	
	(Read) ID share register address (lower)	00h		
	(Read) Number of registers (upper)	00h	Number of registers to be read from the starting ID share register address (14 registers=000Eh) *1	
	(Read) Number of registers (lower)	0Eh		
	(Write) ID share register address (upper)	00h	ID share register address to start writing from (Share Write data 0 (upper))	
	(Write) ID share register address (lower)	00h		
	(Write) Number of registers (upper)	00h	Number of registers to be written from the starting ID share register address (12 registers=000Ch) *2	
	(Write) Number of registers (lower)	0Ch		
	(Write) Number of data bytes	18h	Twice the number of registers in the query	
	Share Control Local ID 1	(Write) Value write to ID share register address (upper)	00h	Value written to ID share register address 0000h
		(Write) Value write to ID share register address (lower)	00h	
		(Write) Value write to ID share register address +1 (upper)	03h	Value written to ID share register address 0001h
		(Write) Value write to ID share register address +1 (lower)	E8h	
		(Write) Value write to ID share register address +2 (upper)	00h	Value written to ID share register address 0002h
		(Write) Value write to ID share register address +2 (lower)	00h	
		(Write) Value write to ID share register address +3 (upper)	03h	Value written to ID share register address 0003h
		(Write) Value write to ID share register address +3 (lower)	E8h	
		(Write) Value write to ID share register address +4 (upper)	00h	Value written to ID share register address 0004h
		(Write) Value write to ID share register address +4 (lower)	00h	
		(Write) Value write to ID share register address +5 (upper)	07h	Value written to ID share register address 0005h
		(Write) Value write to ID share register address +5 (lower)	D0h	
	Share Control Local ID 2	(Write) Value write to ID share register address (upper)	00h	Value written to ID share register address 0000h
		(Write) Value write to ID share register address (lower)	00h	
		(Write) Value write to ID share register address +1 (upper)	07h	Value written to ID share register address 0001h
		(Write) Value write to ID share register address +1 (lower)	D0h	
		(Write) Value write to ID share register address +2 (upper)	00h	Value written to ID share register address 0002h
(Write) Value write to ID share register address +2 (lower)		00h		
(Write) Value write to ID share register address +3 (upper)		07h	Value written to ID share register address 0003h	
(Write) Value write to ID share register address +3 (lower)		D0h		
(Write) Value write to ID share register address +4 (upper)		00h	Value written to ID share register address 0004h	
(Write) Value write to ID share register address +4 (lower)		00h		
(Write) Value write to ID share register address +5 (upper)		13h	Value written to ID share register address 0005h	
(Write) Value write to ID share register address +5 (lower)		88h		
Error check (lower)		A2h	Calculation result of CRC-16	
Error check (upper)		94h		

*1 Number of registers = (number of ID share register addresses to be read + 1) × Share Control Number

*2 Number of registers = (Share Control Number) × Number of ID share register addresses to be written

Note Set so that the number of registers to be read should be 26 × Share Control Number or less.

Response (ID share mode)

Field name		Data	Description	
Slave address		0Fh	Same as query	
Function code		17h	Same as query	
Data	(Read) Number of data bytes	1Ch	Twice the number of registers in the query	
	Share Control Local ID 1	(Read) Value read from ID share register address (upper)	00h	Value read from Share Read data 0 (upper)
		(Read) Value read from ID share register address (lower)	00h	
		(Read) Value read from ID share register address +1 (upper)	00h	Value read from Share Read data 0 (lower)
		(Read) Value read from ID share register address +1 (lower)	00h	
		(Read) Value read from ID share register address +2 (upper)	00h	Value read from Share Read data 1 (upper)
		(Read) Value read from ID share register address +2 (lower)	00h	
		(Read) Value read from ID share register address +3 (upper)	01h	Value read from Share Read data 1 (lower)
		(Read) Value read from ID share register address +3 (lower)	7Fh	
		(Read) Value read from ID share register address +4 (upper)	00h	Value read from Share Read data 2 (upper)
		(Read) Value read from ID share register address +4 (lower)	00h	
		(Read) Value read from ID share register address +5 (upper)	01h	Value read from Share Read data 2 (lower)
		(Read) Value read from ID share register address +5 (lower)	AAh	
		Error check for between slaves (lower)	A2h	The error check value for between slaves is indefinite.
		Error check for between slaves (upper)	04h	
	Share Control Local ID 2	(Read) Value read from ID share register address (upper)	00h	Value read from Share Read data 0 (upper)
		(Read) Value read from ID share register address (lower)	00h	
		(Read) Value read from ID share register address +1 (upper)	00h	Value read from Share Read data 0 (lower)
		(Read) Value read from ID share register address +1 (lower)	30h	
		(Read) Value read from ID share register address +2 (upper)	00h	Value read from Share Read data 1 (upper)
		(Read) Value read from ID share register address +2 (lower)	00h	
		(Read) Value read from ID share register address +3 (upper)	01h	Value read from Share Read data 1 (lower)
		(Read) Value read from ID share register address +3 (lower)	C2h	
		(Read) Value read from ID share register address +4 (upper)	00h	Value read from Share Read data 2 (upper)
		(Read) Value read from ID share register address +4 (lower)	00h	
		(Read) Value read from ID share register address +5 (upper)	02h	Value read from Share Read data 2 (lower)
		(Read) Value read from ID share register address +5 (lower)	1Ah	
		Error check for between slaves (lower)	ACH	The error check value for between slaves is indefinite.
		Error check for between slaves (upper)	AAh	
	Error check (lower)		00h	Calculation result of CRC-16
Error check (upper)		00h		

12-8 Parameter list for Modbus RTU ID share mode

Set parameters necessary for the ID share mode to each slave in the unicast mode before communication.
Refer to p.270 to p.274 for the setting method.

■ Related parameters

Register address		Parameter name	Description	Initial setting	
Upper	Lower			Initial value	Unit
2432 (0980h)	2433 (0981h)	Share control global ID (Modbus)	Sets the communication ID used in the ID share mode. [Setting range] -1: ID share mode is not used 1 to 127: Communication ID to share	-1	-
2434 (0982h)	2435 (0983h)	Share control number (Modbus)	Sets the number of slave axes used in the ID share mode. [Setting range] 1 to 31	1	-
2436 (0984h)	2437 (0985h)	Share control local ID (Modbus)	Sets the ID for identifying the slave used in the ID share mode. [Setting range] 0: ID share mode is not used 1 to 31: ID for slave identification	0	-
2448 (0990h)	2449 (0991h)	Share Read data 0 (Modbus)	Sets the NET-ID of data to be read in the ID share mode. [Setting range] Refer to p.285.	0	-
2450 (0992h)	2451 (0993h)	Share Read data 1 (Modbus)		0	-
2452 (0994h)	2453 (0995h)	Share Read data 2 (Modbus)		0	-
2454 (0996h)	2455 (0997h)	Share Read data 3 (Modbus)		0	-
2456 (0998h)	2457 (0999h)	Share Read data 4 (Modbus)		0	-
2458 (099Ah)	2459 (099Bh)	Share Read data 5 (Modbus)		0	-
2460 (099Ch)	2461 (099Dh)	Share Read data 6 (Modbus)		0	-
2462 (099Eh)	2463 (099Fh)	Share Read data 7 (Modbus)		0	-
2464 (09A0h)	2465 (09A1h)	Share Read data 8 (Modbus)		0	-
2466 (09A2h)	2467 (09A3h)	Share Read data 9 (Modbus)		0	-
2468 (09A4h)	2469 (09A5h)	Share Read data 10 (Modbus)		0	-
2470 (09A6h)	2471 (09A7h)	Share Read data 11 (Modbus)	0	-	
2472 (09A8h)	2473 (09A9h)	Share Write data 0 (Modbus)	Sets the NET-ID of data to be written in the ID share mode. [Setting range] Refer to p.285.	0	-
2474 (09AAh)	2475 (09ABh)	Share Write data 1 (Modbus)		0	-
2476 (09ACh)	2477 (09ADh)	Share Write data 2 (Modbus)		0	-
2478 (09AEh)	2479 (09AFh)	Share Write data 3 (Modbus)		0	-

Register address		Parameter name	Description	Initial setting	
Upper	Lower			Initial value	Unit
2480 (09B0h)	2481 (09B1h)	Share Write data 4 (Modbus)	Sets the NET-ID of data to be written in the ID share mode. [Setting range] Refer to p.285.	0	–
2482 (09B2h)	2483 (09B3h)	Share Write data 5 (Modbus)		0	–
2484 (09B4h)	2485 (09B5h)	Share Write data 6 (Modbus)		0	–
2486 (09B6h)	2487 (09B7h)	Share Write data 7 (Modbus)		0	–
2488 (09B8h)	2489 (09B9h)	Share Write data 8 (Modbus)		0	–
2490 (09BAh)	2491 (09BBh)	Share Write data 9 (Modbus)		0	–
2492 (09BCh)	2493 (09BDh)	Share Write data 10 (Modbus)		0	–
2494 (09BEh)	2495 (09BFh)	Share Write data 11 (Modbus)		0	–

■ Share Control Global ID

The slave address shared with slaves that use the ID share mode is set.
The address of the share group is the value of Share Control Global ID.



- Do not set "0" in the Share Control Global ID.
- Do not set the slave address used by the slave.

■ Share Control Number

The number of slave axes used in the ID share mode is set.

■ Share Control Local ID

The ID for identifying the slave used in the ID share mode is set.



Set one by one in order from "1" in the Share Control Local ID.

■ Commands and parameters that can be set to Share Read data, Share Write data

NET-ID of data to be read/written in the ID share mode is set.

For Share Read data and Share Write data, set "NET-ID" shown in the table below.

NET-ID	Name	Description	Initial setting		R/W
			Initial value	Unit	
44 (002Ch)	Direct data operation operation data number	The operation data of the specified operation data number is transferred to the direct data operation command. Writing a value of the operation data number executes the data transfer. Commands to be transferred are as follows. • Direct data operation operation type • Direct data operation position • Direct data operation operating velocity • Direct data operation acceleration rate • Direct data operation deceleration rate • Direct data operation torque limiting value [Setting range] 0 to 255: Operation data No.0 to No.255	0 *1	–	R/W
45 (002Dh)	Direct data operation operation type	Sets the operation type for direct data operation. [Setting range] Refer to "3-4 Selecting the operation type" on p.63.	0 *2	–	R/W
46 (002Eh)	Direct data operation position	Sets the target position for direct data operation. [Setting range] –2,147,483,648 to 2,147,483,647 (User-defined position unit)	0 *2	step	R/W
47 (002Fh)	Direct data operation operating velocity	Sets the operating velocity for direct data operation. [Setting range] –4,000,000 to 4,000,000 (User-defined velocity unit)	0 *2	r/min	R/W
48 (0030h)	Direct data operation acceleration rate	Sets the acceleration rate (acceleration time) for direct data operation. [Setting range] 1 to 1,000,000,000 (User-defined acceleration/deceleration unit)	1,000 *2	ms	R/W
49 (0031h)	Direct data operation deceleration rate	Sets the deceleration rate (deceleration time) for direct data operation. [Setting range] 1 to 1,000,000,000 (User-defined acceleration/deceleration unit)	1,000 *2	ms	R/W
50 (0032h)	Direct data operation torque limiting value	Sets the torque limiting value for direct data operation. [Setting range] 0 to 10,000 (1=0.1%) *3	10,000 *2	1=0.1%	R/W

NET-ID	Name	Description	Initial setting		R/W
			Initial value	Unit	
51 (0033h)	Direct data operation trigger	<p>Sets the trigger and the lifetime for direct data operation.</p> <p>[Setting range] <Upper 16 bits> Lifetime setting *4 -1, 0: Direct data operation lifetime disable 1 to 32767: Direct data operation lifetime setting value [ms]</p> <p><Lower 16 bits> Trigger setting -7: Operation data number -6: Operation type -5: Position -4: Operating velocity -3: Acceleration rate -2: Deceleration rate -1: Torque limiting value 0: Disable 1 to 3: Normal start 4, 5: Unit specified start (acceleration/deceleration: rate) 6, 7: Unit specified start (acceleration/deceleration: time) 8, 9: Unit specified start (velocity: step/s) 10, 11: Unit specified start (velocity: step/s, acceleration/deceleration: rate) 12, 13: Unit specified start (velocity: step/s, acceleration/deceleration: time) 14, 15: Unit specified start (velocity: r/min) 16, 17: Unit specified start (velocity: r/min, acceleration/deceleration: rate) 18, 19: Unit specified start (velocity: r/min, acceleration/deceleration: time)</p>	0	–	R/W
52 (0034h)	Direct data operation forwarding destination	<p>Selects the stored area when the next direct data is transferred during direct data operation. (Data destination ⇨ p.81)</p> <p>[Setting range] 0: Execution memory 1: Buffer memory</p>	0	–	R/W
58 (003Ah)	Driver input command (2nd)	The same input command as "Driver input command" is automatically set.	0	–	W
60 (003Ch)	Driver input command (automatic OFF)	The same input command as "Driver input command" is automatically set. If the input signal is turned ON with this command, it is automatically turned OFF after 250 μs.	0	–	W
61 (003Dh)	NET selection number	Selects the operation data number. Operation data can be sent at the same time as "Driver input command."	-1	–	R/W
62 (003Eh)	Driver input command	Sets the input command to the driver. (Details of bits arrangement ⇨ p.298)	0	–	W
63 (003Fh)	Driver output status	Reads the output status of the driver. (Details of bits arrangement ⇨ p.298)	–	–	R
64 (0040h)	Present alarm	Indicates the alarm code presently being generated.	–	–	R
75 (004Bh)	Target position (User-defined position unit)	Indicates the present target position. (User-defined position unit)	–	step	R

NET-ID	Name	Description	Initial setting		R/W
			Initial value	Unit	
76 (004Ch)	Demand position (User-defined position unit)	Indicates the present demand position. (User-defined position unit)	–	step	R
77 (004Dh)	Actual position (User-defined position unit)	Indicates the present actual position. (User-defined position unit)	–	step	R
78 (004Eh)	Target velocity (User-defined velocity unit)	Indicates the present target velocity. (User-defined velocity unit)	–	r/min	R
79 (004Fh)	Demand velocity (User-defined velocity unit)	Indicates the present demand velocity. (User-defined velocity unit)	–	r/min	R
80 (0050h)	Actual velocity (User-defined velocity unit)	Indicates the present actual velocity. (User-defined velocity unit)	–	r/min	R
86 (0056h)	Present communication error	Indicates the communication error code received last time.	–	–	R
97 (0061h)	Present selected data number	Indicates the operation data number presently selected. The order of the priority is: NET selection number, direct selection (D-SEL), M0 to M7 inputs.	–	–	R
98 (0062h)	Present operation data number	Indicates the operation data number presently being operated in stored data operation or continuous operation. In operation not using operation data, –1 is displayed. –1 is displayed also during stop.	–	–	R
99 (0063h)	Demand position (step)	Indicates the present demand position. (step)	–	step	R
100 (0064h)	Demand velocity (r/min)	Indicates the present demand velocity. (r/min)	–	r/min	R
101 (0065h)	Demand velocity (step/s)	Indicates the present demand velocity. (step/s)	–	step/s	R
102 (0066h)	Actual position (step)	Indicates the present actual position. (step)	–	step	R
103 (0067h)	Actual velocity (r/min)	Indicates the present actual velocity. (r/min)	–	r/min	R
104 (0068h)	Actual velocity (step/s)	Indicates the present actual velocity. (step/s)	–	step/s	R
105 (0069h)	Remaining dwell time	Indicates the remaining time in the drive-complete delay time or dwell. (ms)	–	ms	R
106 (006Ah)	Direct I/O	Indicates the status of direct I/O. (Arrangement of bits ⇨ p.335)	–	–	R
107 (006Bh)	Torque monitor	Indicates the output torque presently generated as a percentage of the rated torque.	–	1=0.1%	R
108 (006Ch)	Load factor monitor	Indicates the output torque presently generated as a percentage of the maximum torque in the continuous duty region.	–	1=0.1%	R
109 (006Dh)	Cumulative load monitor	Indicates the integrated value of the load during operation. (Internal unit) The load is accumulated regardless of the rotation direction of the motor. (Details of cumulative load monitor ⇨ p.475)	–	–	R
110 (006Eh)	Torque limiting value	Indicates the present torque limiting value. (1=0.1%)	–	1=0.1%	R
112 (0070h)	Next data number	Indicates the operation data number specified in "Next data number" of the operation data in operation. The value is latched even after the operation is completed. When "Link" is "No Link" or "Next data number" is "Stop," –1 is displayed.	–	–	R
113 (0071h)	Loop origin data number	Indicates the operation data number that is the starting point of the loop in loop operation. When loop is not executed or stopped, –1 is displayed.	–	–	R

NET-ID	Name	Description	Initial setting		R/W
			Initial value	Unit	
114 (0072h)	Loop count	Indicates the present number of loop times in loop operation. When operation other than loop is executed or loop is stopped, 0 is displayed.	–	–	R
115 (0073h)	Position deviation	Indicates the deviation between the demand position and the actual position. (User-defined position unit)	–	step	R
117 (0075h)	Speed deviation	Indicates the deviation between the demand velocity and the actual velocity. (User-defined velocity unit)	–	r/min	R
119 (0077h)	Settling time	Indicates the time from when the command is completed until the IN-POS output is turned ON. (ms)	–	ms	R
122 (007Ah)	Tripmeter 1	Indicates the travel distance of the motor in revolutions. (1=0.1 krev) This can be cleared on the customer side.	–	1=0.1 krev	R
124 (007Ch)	Driver temperature	Indicates the present driver temperature. (1=0.1 °C)	–	1=0.1 °C	R
125 (007Dh)	Motor temperature	Indicates the present motor temperature. (1=0.1 °C)	–	1=0.1 °C	R
126 (007Eh)	Odometer	Indicates the cumulative travel distance of the motor in revolutions. (1=0.1 krev) This cannot be cleared on the customer side.	–	1=0.1 krev	R
127 (007Fh)	Tripmeter 0	Indicates the travel distance of the motor in revolutions. (1=0.1 krev) This can be cleared on the customer side.	–	1=0.1 krev	R
144 (0090h)	Actual position 32-bit counter (User-defined position unit)	This is the actual position 32-bit counter. Counts independently of the WRAP function.	–	step	R
145 (0091h)	Demand position 32-bit counter (User-defined position unit)	This is the demand position 32-bit counter. Counts independently of the WRAP function.	–	step	R
147 (0093h)	Loop count buffer	Indicates the present number of loop times in loop operation. The value is kept until the operation start signal is turned ON.	–	–	R
150 (0096h)	Corrected max software limit	Indicates the maximum value of the software limit.	–	step	R
151 (0097h)	Corrected min software limit	Indicates the minimum value of the software limit.	–	step	R
155 (009Bh)	Main power supply current	Indicates the present current value of the main power supply. (1=0.001 A)	–	1=0.001 A	R
156 (009Ch)	Power consumption	Indicates the present power consumption. (1=0.1 W)	–	1=0.1 W	R
157 (009Dh)	Energy consumption	Indicates the present energy consumption. (1=0.001 Wh)	–	1=0.001 Wh	R
158 (009Eh)	User energy consumption	Indicates the total energy consumption. (Wh) This can be cleared on the customer side.	–	Wh	R
159 (009Fh)	Total energy consumption	Indicates the total energy consumption. (Wh) This cannot be cleared on the customer side.	–	Wh	R
161 (00A1h)	Total uptime	Indicates the total time that has elapsed since the main power supply was turned on. (min)	–	min	R
162 (00A2h)	Number of boots	Indicates the total number of times that the driver was started.	–	–	R
163 (00A3h)	Inverter voltage	Indicates the inverter voltage of the driver. (1=0.1 V)	–	1=0.1 V	R
164 (00A4h)	Main power supply voltage	Indicates the main power supply voltage. (1=0.1 V)	–	1=0.1 V	R

NET-ID	Name	Description	Initial setting		R/W
			Initial value	Unit	
169 (00A9h)	Continuous uptime	Indicates the time at which the main power supply is supplied continuously. (ms)	–	ms	R
170 (00AAh)	RS-485 communication reception byte counter	Indicates the number of bytes received.	–	–	R
171 (00ABh)	RS-485 communication transmission byte counter	Indicates the number of bytes transmitted.	–	–	R
172 (00ACh)	RS-485 communication normal reception frame counter (All)	Indicates the number of normal frames received.	–	–	R
173 (00ADh)	RS-485 communication normal reception frame counter (Only own address)	Indicates the number of normal frames received to own address.	–	–	R
174 (00AEh)	RS-485 communication abnormal reception frame counter (All)	Indicates the number of abnormal frames received.	–	–	R
175 (00AFh)	RS-485 communication transmission frame counter	Indicates the number of frames transmitted.	–	–	R
176 (00B0h)	RS-485 communication register write error counter	Indicates the number of times the register write error occurred.	–	–	R
177 (00B1h)	RS-485 communication valid frame/second	Indicates the number of valid frames per second.	–	–	R
178 (00B2h)	RS-485 communication processing time	Indicates the communication processing time for RS-485 communication.	–	ms	R
179 (00B3h)	RS-485 communication maximum processing time	Indicates the maximum communication processing time after turning on the power.	–	ms	R
180 (00B4h)	RS-485 communication interval	Indicates the communication interval for RS-485 communication.	–	ms	R
181 (00B5h)	RS-485 communication maximum interval	Indicates the maximum communication interval for RS-485 communication.	–	ms	R
184 (00B8h)	I/O status 1	Indicates the ON-OFF status of the internal I/O. (Arrangement of bits ⇨ p.336)	–	–	R
185 (00B9h)	I/O status 2		–	–	R
186 (00BAh)	I/O status 3		–	–	R
187 (00BBh)	I/O status 4		–	–	R
188 (00BCh)	I/O status 5		–	–	R
189 (00BDh)	I/O status 6		–	–	R
190 (00BEh)	I/O status 7		–	–	R
191 (00BFh)	I/O status 8		–	–	R
1392 (0570h)	Information status	Indicates the information status presently being generated. (Arrangement of bits ⇨ p.334)	–	–	R
1393 (0571h)					R
1394 (0572h)					R
1395 (0573h)					R

NET-ID	Name	Description	Initial setting		R/W
			Initial value	Unit	
1396 (0574h)	Information count	Indicates the number of times that information was generated.	–	–	R
1408 (0580h)	Latch monitor status (USR-LAT0: POS-EDGE)	Indicates the status of the latch by the USR-LAT0 input (positive edge).	–	–	R
1409 (0581h)	Latch monitor demand position (USR-LAT0: POS-EDGE)	Indicates the demand position latched by the USR-LAT0 input (positive edge).	–	step	R
1410 (0582h)	Latch monitor actual position (USR-LAT0: POS-EDGE)	Indicates the actual position latched by the USR-LAT0 input (positive edge).	–	step	R
1411 (0583h)	Latch monitor target position (USR-LAT0: POS-EDGE)	Indicates the target position latched by the USR-LAT0 input (positive edge).	–	step	R
1412 (0584h)	Latch monitor operation number (USR-LAT0: POS-EDGE)	Indicates the operation number latched by the USR-LAT0 input (positive edge).	–	–	R
1413 (0585h)	Latch monitor number of loop (USR-LAT0: POS-EDGE)	Indicates the number of loop times latched by the USR-LAT0 input (positive edge).	–	–	R
1414 (0586h)	Latch monitor number of latch (USR-LAT0: POS-EDGE)	Indicates the number of times latched by the USR-LAT0 input (positive edge).	–	–	R
1415 (0587h)	Latch monitor number of continuous uptime (USR-LAT0: POS-EDGE)	Indicates the number of continuous uptime latched by the USR-LAT0 input (positive edge).	–	ms	R
1416 (0588h)	Latch monitor status (USR-LAT0: NEG-EDGE)	Indicates the status of the latch by the USR-LAT0 input (negative edge).	–	–	R
1417 (0589h)	Latch monitor demand position (USR-LAT0: NEG-EDGE)	Indicates the demand position latched by the USR-LAT0 input (negative edge).	–	step	R
1418 (058Ah)	Latch monitor actual position (USR-LAT0: NEG-EDGE)	Indicates the actual position latched by the USR-LAT0 input (negative edge).	–	step	R
1419 (058Bh)	Latch monitor target position (USR-LAT0: NEG-EDGE)	Indicates the target position latched by the USR-LAT0 input (negative edge).	–	step	R
1420 (058Ch)	Latch monitor operation number (USR-LAT0: NEG-EDGE)	Indicates the operation number latched by the USR-LAT0 input (negative edge).	–	–	R
1421 (058Dh)	Latch monitor number of loop (USR-LAT0: NEG-EDGE)	Indicates the number of loop times latched by the USR-LAT0 input (negative edge).	–	–	R
1422 (058Eh)	Latch monitor number of latch (USR-LAT0: NEG-EDGE)	Indicates the number of times latched by the USR-LAT0 input (negative edge).	–	–	R
1423 (058Fh)	Latch monitor number of continuous uptime (USR-LAT0: NEG-EDGE)	Indicates the number of continuous uptime latched by the USR-LAT0 input (negative edge).	–	ms	R
1424 (0590h)	Latch monitor status (USR-LAT1: POS-EDGE)	Indicates the status of the latch by the USR-LAT1 input (positive edge).	–	–	R
1425 (0591h)	Latch monitor demand position (USR-LAT1: POS-EDGE)	Indicates the demand position latched by the USR-LAT1 input (positive edge).	–	step	R
1426 (0592h)	Latch monitor actual position (USR-LAT1: POS-EDGE)	Indicates the actual position latched by the USR-LAT1 input (positive edge).	–	step	R
1427 (0593h)	Latch monitor target position (USR-LAT1: POS-EDGE)	Indicates the target position latched by the USR-LAT1 input (positive edge).	–	step	R
1428 (0594h)	Latch monitor operation number (USR-LAT1: POS-EDGE)	Indicates the operation number latched by the USR-LAT1 input (positive edge).	–	–	R
1429 (0595h)	Latch monitor number of loop (USR-LAT1: POS-EDGE)	Indicates the number of loop times latched by the USR-LAT1 input (positive edge).	–	–	R
1430 (0596h)	Latch monitor number of latch (USR-LAT1: POS-EDGE)	Indicates the number of times latched by the USR-LAT1 input (positive edge).	–	–	R
1431 (0597h)	Latch monitor number of continuous uptime (USR-LAT1: POS-EDGE)	Indicates the number of continuous uptime latched by the USR-LAT1 input (positive edge).	–	ms	R

NET-ID	Name	Description	Initial setting		R/W
			Initial value	Unit	
1432 (0598h)	Latch monitor status (USR-LAT1: NEG-EDGE)	Indicates the status of the latch by the USR-LAT1 input (negative edge).	–	–	R
1433 (0599h)	Latch monitor demand position (USR-LAT1: NEG-EDGE)	Indicates the demand position latched by the USR-LAT1 input (negative edge).	–	step	R
1434 (059Ah)	Latch monitor actual position (USR-LAT1: NEG-EDGE)	Indicates the actual position latched by the USR-LAT1 input (negative edge).	–	step	R
1435 (059Bh)	Latch monitor target position (USR-LAT1: NEG-EDGE)	Indicates the target position latched by the USR-LAT1 input (negative edge).	–	step	R
1436 (059Ch)	Latch monitor operation number (USR-LAT1: NEG-EDGE)	Indicates the operation number latched by the USR-LAT1 input (negative edge).	–	–	R
1437 (059Dh)	Latch monitor number of loop (USR-LAT1: NEG-EDGE)	Indicates the number of loop times latched by the USR-LAT1 input (negative edge).	–	–	R
1438 (059Eh)	Latch monitor number of latch (USR-LAT1: NEG-EDGE)	Indicates the number of times latched by the USR-LAT1 input (negative edge).	–	–	R
1439 (059Fh)	Latch monitor number of continuous uptime (USR-LAT1: NEG-EDGE)	Indicates the number of continuous uptime latched by the USR-LAT1 input (negative edge).	–	ms	R
1440 (05A0h)	Latch monitor status (IO event – low event)	Indicates the status of the latch by the low event.	–	–	R
1441 (05A1h)	Latch monitor demand position (IO event – low event)	Indicates the demand position latched by the low event.	–	step	R
1442 (05A2h)	Latch monitor actual position (IO event – low event)	Indicates the actual position latched by the low event.	–	step	R
1443 (05A3h)	Latch monitor target position (IO event – low event)	Indicates the target position latched by the low event.	–	step	R
1444 (05A4h)	Latch monitor operation number (IO event – low event)	Indicates the operation number latched by the low event.	–	–	R
1445 (05A5h)	Latch monitor number of loop (IO event – low event)	Indicates the number of loop times latched by the low event.	–	–	R
1446 (05A6h)	Latch monitor number of latch (IO event – low event)	Indicates the number of times latched by the low event.	–	–	R
1447 (05A7h)	Latch monitor number of continuous uptime (IO event – low event)	Indicates the number of continuous uptime latched by the low event.	–	ms	R
1448 (05A8h)	Latch monitor status (IO event – middle event)	Indicates the status of the latch by the middle event.	–	–	R
1449 (05A9h)	Latch monitor demand position (IO event – middle event)	Indicates the demand position latched by the middle event.	–	step	R
1450 (05AAh)	Latch monitor actual position (IO event – middle event)	Indicates the actual position latched by the middle event.	–	step	R
1451 (05ABh)	Latch monitor target position (IO event – middle event)	Indicates the target position latched by the middle event.	–	step	R
1452 (05ACh)	Latch monitor operation number (IO event – middle event)	Indicates the operation number latched by the middle event.	–	–	R
1453 (05ADh)	Latch monitor number of loop (IO event – middle event)	Indicates the number of loop times latched by the middle event.	–	–	R
1454 (05AEh)	Latch monitor number of latch (IO event – middle event)	Indicates the number of times latched by the middle event.	–	–	R
1455 (05AFh)	Latch monitor number of continuous uptime (IO event – middle event)	Indicates the number of continuous uptime latched by the middle event.	–	ms	R
1456 (05B0h)	Latch monitor status (IO event – high event)	Indicates the status of the latch by the high event.	–	–	R

NET-ID	Name	Description	Initial setting		R/W
			Initial value	Unit	
1457 (05B1h)	Latch monitor demand position (IO event – high event)	Indicates the demand position latched by the high event.	–	step	R
1458 (05B2h)	Latch monitor actual position (IO event – high event)	Indicates the actual position latched by the high event.	–	step	R
1459 (05B3h)	Latch monitor target position (IO event – high event)	Indicates the target position latched by the high event.	–	step	R
1460 (05B4h)	Latch monitor operation number (IO event – high event)	Indicates the operation number latched by the high event.	–	–	R
1461 (05B5h)	Latch monitor number of loop (IO event – high event)	Indicates the number of loop times latched by the high event.	–	–	R
1462 (05B6h)	Latch monitor number of latch (IO event – high event)	Indicates the number of times latched by the high event.	–	–	R
1463 (05B7h)	Latch monitor number of continuous uptime (IO event – high event)	Indicates the number of continuous uptime latched by the high event.	–	ms	R
1464 (05B8h)	Latch monitor status (STOP)	Indicates the status of the latch by the stop input.	–	–	R
1465 (05B9h)	Latch monitor demand position (STOP)	Indicates the demand position latched by the stop input.	–	step	R
1466 (05BAh)	Latch monitor actual position (STOP)	Indicates the actual position latched by the stop input.	–	step	R
1467 (05BBh)	Latch monitor target position (STOP)	Indicates the target position latched by the stop input.	–	step	R
1468 (05BCh)	Latch monitor operation number (STOP)	Indicates the operation number latched by the stop input.	–	–	R
1469 (05BDh)	Latch monitor number of loop (STOP)	Indicates the number of loop times latched by the stop input.	–	–	R
1470 (05BEh)	Latch monitor number of latch (STOP)	Indicates the number of times latched by the stop input.	–	–	R
1471 (05BFh)	Latch monitor number of continuous uptime (STOP)	Indicates the number of continuous uptime latched by the stop input.	–	ms	R
1472 (05C0h)	Latch monitor status (NEXT)	Indicates the status of the latch by the NEXT input.	–	–	R
1473 (05C1h)	Latch monitor demand position (NEXT)	Indicates the demand position latched by the NEXT input.	–	step	R
1474 (05C2h)	Latch monitor actual position (NEXT)	Indicates the actual position latched by the NEXT input.	–	step	R
1475 (05C3h)	Latch monitor target position (NEXT)	Indicates the target position latched by the NEXT input.	–	step	R
1476 (05C4h)	Latch monitor operation number (NEXT)	Indicates the operation number latched by the NEXT input.	–	–	R
1477 (05C5h)	Latch monitor number of loop (NEXT)	Indicates the number of loop times latched by the NEXT input.	–	–	R
1478 (05C6h)	Latch monitor number of latch (NEXT)	Indicates the number of times latched by the NEXT input.	–	–	R
1479 (05C7h)	Latch monitor number of continuous uptime (NEXT)	Indicates the number of continuous uptime latched by the NEXT input.	–	ms	R
1619 (0653h)	Continuous operating time *4	Indicates the elapsed time from starting operation. 0 is shown during stop.	–	ms	R
1620 (0654h)	Continuous operating time buffer *4	Indicates the elapsed time from starting operation. The value is kept until operation is started.	–	ms	R
192 (00C0h)	Alarm reset	Resets the alarm being generated presently. Some alarms cannot be reset.	–	–	W

NET-ID	Name	Description	Initial setting		R/W
			Initial value	Unit	
211 (00D3h)	Clear information	Clears the information.	–	–	W
223 (00DFh)	Stop operation	Stops the operation.	–	–	W

- *1 The value set in the "Direct data operation operation parameter initial value reference data number" parameter will be the initial value.
- *2 The operation data of the operation data number set in the "Direct data operation operation parameter initial value reference data number" parameter will be the initial value.
- *3 The maximum torque limiting value varies depending on the motor. Refer to p.39 for the maximum value of each motor.
- *4 It is effective for the driver version 3.00 or later.

6 Address codes list

◆Table of contents

1	Timing for parameter to update	296	13	Parameter R/W commands.....	348
2	I/O commands	297	13-1	Basic setting and operation setting	348
3	Group command	299	13-2	Unit setting, coordinate setting, mechanism setting, jog setting, homing setting.....	351
4	Protect release commands.....	300	13-3	Communication setting (Modbus/CANopen) ...	356
5	Direct data operation commands.....	301	13-4	Communication setting (Modbus/CANopen) (compatible).....	365
6	Modbus indirect reference commands.....	303	13-5	Modbus ID share mode setting	366
7	Modbus indirect reference commands (compatible).....	311	13-6	Power removal setting, ETO setting, and alarm setting.....	368
8	General purpose registers.....	313	13-7	I/O operation and function	370
9	Maintenance commands	315	13-8	Direct-IN function selection (DIN).....	379
9-1	How to execute the maintenance commands.....	316	13-9	Direct-OUT function selection (DOUT)	380
9-2	Reset communication	317	13-10	Remote-I/O function selection (R-I/O).....	381
10	Monitor commands	318	13-11	Adjustment and function.....	385
11	Operation data R/W commands.....	338	13-12	Information setting	388
11-1	Direct reference	338	13-13	USB and LED functions	397
11-2	Offset reference	343	13-14	User output function selection	401
12	Operation I/O event R/W commands	344	13-15	Virtual input function selection (VIN).....	406
12-1	Setting method.....	344	13-16	Data transfer	408
12-2	Direct reference	344	13-17	General purpose registers.....	415
12-3	Offset reference	346	13-18	Latch function	417
			13-19	CANopen objects.....	418
			14	I/O signals assignment list.....	424
			14-1	Input signals.....	424
			14-2	Output signals.....	425

1 Timing for parameter to update

All data used with the driver is 32 bits wide. Therefore, when accessed with NET-ID, one register represents one data. With the Modbus protocol, since the register is 16 bits wide, two registers represent one data.

Parameters are stored in RAM or non-volatile memory. The parameters stored in RAM are erased once the main power supply is shut off, however, the parameters stored in the non-volatile memory are retained even if the main power supply is shut off.

When the main power supply of the driver is turned on, the parameters stored in the non-volatile memory are sent to RAM, and the recalculation and setup for the parameters are executed in RAM.

When parameters are set via communication, they are stored in RAM. To save the parameters stored in RAM to the non-volatile memory, execute the "Write batch NV memory" of the maintenance command.

The parameters set with the support software will be stored in the non-volatile memory if "Data writing" is performed.

When a parameter is changed, the timing to update the new value varies depending on the parameter. See the following four types.

- Update immediately.....Recalculation and setup are immediately executed when the parameter is written.
- Update after operation stop.....Recalculation and setup are executed when the operation is stopped.
- Update after executing Configuration.....Recalculation and setup are executed after Configuration is executed or the main power supply is turned on again.
- Update after turning on the main power supply againRecalculation and setup are executed after the main power supply is turned on again.



- Parameters set via communication are stored in RAM. When changing a parameter that requires to turn on the main power supply again to update data, be sure to store it in the non-volatile memory before turning off the main power supply.
- The non-volatile memory can be rewritten approximately 100,000 times.

■ Notation rules

In this part, each update timing is represented in an alphabet.

A: Update immediately

B: Update after operation stop

C: Update after executing Configuration or turning on the main power supply again

D: Update after turning on the main power supply again

READ/WRITE may be represented as "R/W" in this part.

2 I/O commands

These are commands related to I/O. The set value is stored in RAM.

Modbus communication register address		Name	Description	R/W	Initial setting		NET-ID
Upper	Lower				Initial value	Unit	
114 (0072h)	115 (0073h)	NET selection data number	Selects the operation data number. Operation data can be sent at the same time as "Driver input command (2nd)."	R/W	-1	-	57 (0039h)
116 (0074h)	117 (0075h)	Driver input command (2nd)	The same input command as "Driver input command" is automatically set.	R/W	0	-	58 (003Ah)
118 (0076h)	119 (0077h)	NET selection data number	Selects the operation data number. Operation data can be sent at the same time as "Driver input command (automatic OFF)."	R/W	-1	-	59 (003Bh)
120 (0078h)	121 (0079h)	Driver input command (automatic OFF)	The same input command as "Driver input command" is automatically set. If the input signal is turned ON with this command, it is automatically turned OFF after 250 μ s.	R/W	0	-	60 (003Ch)
122 (007Ah)	123 (007Bh)	NET selection data number	Selects the operation data number. Operation data can be sent at the same time as "Driver input command."	R/W	-1	-	61 (003Dh)
124 (007Ch)	125 (007Dh)	Driver input command	Sets the input command to the driver. (Details of bits arrangement \Rightarrow Next section)	R/W	0	-	62 (003Eh)
126 (007Eh)	127 (007Fh)	Driver output status	Reads the output status of the driver. (Details of bits arrangement \Rightarrow p.298)	R	-	-	63 (003Fh)

■ Driver input command

These are the driver input signals that can be accessed via Modbus communication. They can also be accessed in units of one register (16 bits).

Values in brackets [] are initial values. They can be changed using the parameter.

(Parameters ⇨ p.381, assignment of input signals ⇨ p.151)

● Upper

Register address	Description							
124 (007Ch)	bit 15	bit 14	bit 13	bit 12	bit 11	bit 10	bit 9	bit 8
	R-IN31 [M7]	R-IN30 [M6]	R-IN29 [M5]	R-IN28 [M4]	R-IN27 [M3]	R-IN26 [M2]	R-IN25 [M1]	R-IN24 [M0]
	bit 7	bit 6	bit 5	bit 4	bit 3	bit 2	bit 1	bit 0
	R-IN23 [SSTART]	R-IN22 [START]	R-IN21 [Not used]	R-IN20 [HOME]	R-IN19 [RV-SPD]	R-IN18 [FW-SPD]	R-IN17 [RV-JOG-P]	R-IN16 [FW-JOG-P]

● Lower

Register address	Description							
125 (007Dh)	bit 15	bit 14	bit 13	bit 12	bit 11	bit 10	bit 9	bit 8
	R-IN15 [D-SEL7]	R-IN14 [D-SEL6]	R-IN13 [D-SEL5]	R-IN12 [D-SEL4]	R-IN11 [D-SEL3]	R-IN10 [D-SEL2]	R-IN9 [D-SEL1]	R-IN8 [D-SEL0]
	bit 7	bit 6	bit 5	bit 4	bit 3	bit 2	bit 1	bit 0
	R-IN7 [ALM-RST]	R-IN6 [FREE]	R-IN5 [STOP]	R-IN4 [QSTOP]	R-IN3 [CLR]	R-IN2 [TRQ-LMT]	R-IN1 [PLOOP-MODE]	R-IN0 [S-ON]



Input "0" for the bit that "Not used" is set.

■ Driver output status

These are the driver output signals that can be accessed via Modbus communication. They can also be accessed in units of one register (16 bits).

Values in brackets [] are initial values. They can be changed using the parameter.

(Parameters ⇨ p.381, assignment of output signals ⇨ p.154)

● Upper

Register address	Description							
126 (007Eh)	bit 15	bit 14	bit 13	bit 12	bit 11	bit 10	bit 9	bit 8
	R-OUT31 [USR-OUT1]	R-OUT30 [USR-OUT0]	R-OUT29 [CONST-OFF]	R-OUT28 [CONST-OFF]	R-OUT27 [CONST-OFF]	R-OUT26 [CONST-OFF]	R-OUT25 [INFO- USRIO-G]	R-OUT24 [INFO- START-G]
	bit 7	bit 6	bit 5	bit 4	bit 3	bit 2	bit 1	bit 0
	R-OUT23 [INFO- VOLT-L]	R-OUT22 [INFO- VOLT-H]	R-OUT21 [INFO-WATT]	R-OUT20 [INFO-TRQ]	R-OUT19 [INFO_ MTRTMP]	R-OUT18 [INFO- DRVTMP]	R-OUT17 [INFO-MNT-G]	R-OUT16 [INFO]

● Lower

Register address	Description							
127 (007Fh)	bit 15	bit 14	bit 13	bit 12	bit 11	bit 10	bit 9	bit 8
	R-OUT15 [TLC]	R-OUT14 [VA]	R-OUT13 [MOVE]	R-OUT12 [RDY-SD-OPE]	R-OUT11 [RDY-FWRV-OPE]	R-OUT10 [RDY-HOME-OPE]	R-OUT9 [IN-POS]	R-OUT8 [SYS-BSY]
	bit 7	bit 6	bit 5	bit 4	bit 3	bit 2	bit 1	bit 0
	R-OUT7 [ALM-A]	R-OUT6 [FREE_R]	R-OUT5 [STOP_R]	R-OUT4 [ABSPEN]	R-OUT3 [RDY-DD-OPE]	R-OUT2 [TRQ-LMTD]	R-OUT1 [PLOOP-MON]	R-OUT0 [SON-MON]

3 Group command

This is a command related to group send. The set value is stored in RAM.

Modbus communication register address		Name	Description	R/W	Initial setting		NET-ID
Upper	Lower				Initial value	Unit	
48 (0030h)	49 (0031h)	Group ID	Sets an address of the group. *1 [Setting range] -1: No group specification (group send is not performed) 1 to 31: The address (address of the parent slave) of the group	R/W	-1 *2	-	24 (0018h)

*1 Do not set "0" to the group ID.

*2 The initial value can be changed using the "Initial group ID (Modbus)" parameter.

4 Protect release commands

The key code to release the function limitation by the HMI input is set.

Modbus communication register address		Name	Description	R/W	Initial setting		NET-ID
Upper	Lower				Initial value	Unit	
68 (0044h)	69 (0045h)	HMI release key	Inputs the key code to release the limitation by the HMI input. (Key code ⇨ Next table)	R/W	0	–	34 (0022h)

Key code table

Process that requires protect release	Command name	Key code
Release of limitation by HMI input	HMI release key	864617234 (33890312h)

5 Direct data operation commands

These are commands used when direct data operation is performed. The set value is stored in RAM.
All commands can be read and written (READ/WRITE).

Modbus communication register address		Name	Description	R/W	Initial setting		NET-ID
Upper	Lower				Initial value	Unit	
88 (0058h)	89 (0059h)	Direct data operation operation data number	The operation data of the specified operation data number is transferred to the direct data operation command. Writing a value of the operation data number executes the data transfer. Commands to be transferred are as follows. <ul style="list-style-type: none"> • Direct data operation operation type • Direct data operation position • Direct data operation operating velocity • Direct data operation acceleration rate • Direct data operation deceleration rate • Direct data operation torque limiting value <p>[Setting range] 0 to 255: Operation data No.0 to No.255</p>	R/W	0 *1	–	44 (002Ch)
90 (005Ah)	91 (005Bh)	Direct data operation operation type	Sets the operation type for direct data operation. [Setting range] Refer to "3-4 Selecting the operation type" on p.63.	R/W	0 *2	–	45 (002Dh)
92 (005Ch)	93 (005Dh)	Direct data operation position	Sets the target position for direct data operation. [Setting range] –2,147,483,648 to 2,147,483,647 (User-defined position unit)	R/W	0 *2	step	46 (002Eh)
94 (005Eh)	95 (005Fh)	Direct data operation operating velocity	Sets the operating velocity for direct data operation. [Setting range] –4,000,000 to 4,000,000 (User-defined velocity unit)	R/W	0 *2	r/min	47 (002Fh)
96 (0060h)	97 (0061h)	Direct data operation acceleration rate	Sets the acceleration rate (acceleration time) for direct data operation. [Setting range] 1 to 1,000,000,000 (User-defined acceleration/deceleration unit)	R/W	1,000 *2	ms	48 (0030h)
98 (0062h)	99 (0063h)	Direct data operation deceleration rate	Sets the deceleration rate (deceleration time) for direct data operation. [Setting range] 1 to 1,000,000,000 (User-defined acceleration/deceleration unit)	R/W	1,000 *2	ms	49 (0031h)
100 (0064h)	101 (0065h)	Direct data operation torque limiting value	Sets the torque limiting value for direct data operation. [Setting range] 0 to 10,000 (1=0.1%) *3	R/W	10,000 *2	1=0.1%	50 (0032h)

Modbus communication register address		Name	Description	R/W	Initial setting		NET-ID
Upper	Lower				Initial value	Unit	
102 (0066h)	103 (0067h)	Direct data operation trigger	Sets the trigger and the lifetime for direct data operation. [Setting range] <Upper 16 bits> Lifetime setting *4 -1, 0: Direct data operation lifetime disable 1 to 32767: Direct data operation lifetime setting value [ms] <Lower 16 bits> Trigger setting -7: Operation data number -6: Operation type -5: Position -4: Operating velocity -3: Acceleration rate -2: Deceleration rate -: Torque limiting value 0: Disable 1 to 3: Normal start 4, 5: Unit specified start (acceleration/deceleration: rate) 6, 7: Unit specified start (acceleration/deceleration: time) 8, 9: Unit specified start (velocity: step/s) 10, 11: Unit specified start (velocity: step/s, acceleration/deceleration: rate) 12, 13: Unit specified start (velocity: step/s, acceleration/deceleration: time) 14, 15: Unit specified start (velocity: r/min) 16, 17: Unit specified start (velocity: r/min, acceleration/deceleration: rate) 18, 19: Unit specified start (velocity: r/min, acceleration/deceleration: time)	R/W	0	–	51 (0033h)
104 (0068h)	105 (0069h)	Direct data operation forwarding destination	Selects the stored area when the next direct data is transferred during direct data operation. [Setting range] 0: Execution memory 1: Buffer memory	R/W	0	–	52 (0034h)

*1 The value set in the "Direct data operation operation parameter initial value reference data number" parameter will be the initial value.

*2 The operation data of the operation data number set in the "Direct data operation operation parameter initial value reference data number" parameter will be the initial value.

*3 The maximum torque limiting value varies depending on the motor. Refer to p.39 for the maximum value of each motor.

*4 It is effective for the driver version 3.00 or later.

6 Modbus indirect reference commands

These are commands used when indirect reference is performed via Modbus RTU communication. The set value is stored in RAM.

All commands can be read and written (READ/WRITE).

Modbus communication register address		Name	Description	R/W	Initial setting		NET-ID
Upper	Lower				Initial value	Unit	
1792 (0700h)	1793 (0701h)	Indirect reference area 0	This is an area to read/write from/to the parameter or command registered in the indirect reference address (0).	R/W	–	–	896 (0380h)
1794 (0702h)	1795 (0703h)	Indirect reference area 1	This is an area to read/write from/to the parameter or command registered in the indirect reference address (1).	R/W	–	–	897 (0381h)
1796 (0704h)	1797 (0705h)	Indirect reference area 2	This is an area to read/write from/to the parameter or command registered in the indirect reference address (2).	R/W	–	–	898 (0382h)
1798 (0706h)	1799 (0707h)	Indirect reference area 3	This is an area to read/write from/to the parameter or command registered in the indirect reference address (3).	R/W	–	–	899 (0383h)
1800 (0708h)	1801 (0709h)	Indirect reference area 4	This is an area to read/write from/to the parameter or command registered in the indirect reference address (4).	R/W	–	–	900 (0384h)
1802 (070Ah)	1803 (070Bh)	Indirect reference area 5	This is an area to read/write from/to the parameter or command registered in the indirect reference address (5).	R/W	–	–	901 (0385h)
1804 (070Ch)	1805 (070Dh)	Indirect reference area 6	This is an area to read/write from/to the parameter or command registered in the indirect reference address (6).	R/W	–	–	902 (0386h)
1806 (070Eh)	1807 (070Fh)	Indirect reference area 7	This is an area to read/write from/to the parameter or command registered in the indirect reference address (7).	R/W	–	–	903 (0387h)
1808 (0710h)	1809 (0711h)	Indirect reference area 8	This is an area to read/write from/to the parameter or command registered in the indirect reference address (8).	R/W	–	–	904 (0388h)
1810 (0712h)	1811 (0713h)	Indirect reference area 9	This is an area to read/write from/to the parameter or command registered in the indirect reference address (9).	R/W	–	–	905 (0389h)
1812 (0714h)	1813 (0715h)	Indirect reference area 10	This is an area to read/write from/to the parameter or command registered in the indirect reference address (10).	R/W	–	–	906 (038Ah)
1814 (0716h)	1815 (0717h)	Indirect reference area 11	This is an area to read/write from/to the parameter or command registered in the indirect reference address (11).	R/W	–	–	907 (038Bh)
1816 (0718h)	1817 (0719h)	Indirect reference area 12	This is an area to read/write from/to the parameter or command registered in the indirect reference address (12).	R/W	–	–	908 (038Ch)
1818 (071Ah)	1819 (071Bh)	Indirect reference area 13	This is an area to read/write from/to the parameter or command registered in the indirect reference address (13).	R/W	–	–	909 (038Dh)
1820 (071Ch)	1821 (071Dh)	Indirect reference area 14	This is an area to read/write from/to the parameter or command registered in the indirect reference address (14).	R/W	–	–	910 (038Eh)

Modbus communication register address		Name	Description	R/W	Initial setting		NET-ID
Upper	Lower				Initial value	Unit	
1822 (071Eh)	1823 (071Fh)	Indirect reference area 15	This is an area to read/write from/to the parameter or command registered in the indirect reference address (15).	R/W	–	–	911 (038Fh)
1824 (0720h)	1825 (0721h)	Indirect reference area 16	This is an area to read/write from/to the parameter or command registered in the indirect reference address (16).	R/W	–	–	912 (0390h)
1826 (0722h)	1827 (0723h)	Indirect reference area 17	This is an area to read/write from/to the parameter or command registered in the indirect reference address (17).	R/W	–	–	913 (0391h)
1828 (0724h)	1829 (0725h)	Indirect reference area 18	This is an area to read/write from/to the parameter or command registered in the indirect reference address (18).	R/W	–	–	914 (0392h)
1830 (0726h)	1831 (0727h)	Indirect reference area 19	This is an area to read/write from/to the parameter or command registered in the indirect reference address (19).	R/W	–	–	915 (0393h)
1832 (0728h)	1833 (0729h)	Indirect reference area 20	This is an area to read/write from/to the parameter or command registered in the indirect reference address (20).	R/W	–	–	916 (0394h)
1834 (072Ah)	1835 (072Bh)	Indirect reference area 21	This is an area to read/write from/to the parameter or command registered in the indirect reference address (21).	R/W	–	–	917 (0395h)
1836 (072Ch)	1837 (072Dh)	Indirect reference area 22	This is an area to read/write from/to the parameter or command registered in the indirect reference address (22).	R/W	–	–	918 (0396h)
1838 (072Eh)	1839 (072Fh)	Indirect reference area 23	This is an area to read/write from/to the parameter or command registered in the indirect reference address (23).	R/W	–	–	919 (0397h)
1840 (0730h)	1841 (0731h)	Indirect reference area 24	This is an area to read/write from/to the parameter or command registered in the indirect reference address (24).	R/W	–	–	920 (0398h)
1842 (0732h)	1843 (0733h)	Indirect reference area 25	This is an area to read/write from/to the parameter or command registered in the indirect reference address (25).	R/W	–	–	921 (0399h)
1844 (0734h)	1845 (0735h)	Indirect reference area 26	This is an area to read/write from/to the parameter or command registered in the indirect reference address (26).	R/W	–	–	922 (039Ah)
1846 (0736h)	1847 (0737h)	Indirect reference area 27	This is an area to read/write from/to the parameter or command registered in the indirect reference address (27).	R/W	–	–	923 (039Bh)
1848 (0738h)	1849 (0739h)	Indirect reference area 28	This is an area to read/write from/to the parameter or command registered in the indirect reference address (28).	R/W	–	–	924 (039Ch)
1850 (073Ah)	1851 (073Bh)	Indirect reference area 29	This is an area to read/write from/to the parameter or command registered in the indirect reference address (29).	R/W	–	–	925 (039Dh)
1852 (073Ch)	1853 (073Dh)	Indirect reference area 30	This is an area to read/write from/to the parameter or command registered in the indirect reference address (30).	R/W	–	–	926 (039Eh)
1854 (073Eh)	1855 (073Fh)	Indirect reference area 31	This is an area to read/write from/to the parameter or command registered in the indirect reference address (31).	R/W	–	–	927 (039Fh)
1856 (0740h)	1857 (0741h)	Indirect reference area 32	This is an area to read/write from/to the parameter or command registered in the indirect reference address (32).	R/W	–	–	928 (03A0h)

Modbus communication register address		Name	Description	R/W	Initial setting		NET-ID
Upper	Lower				Initial value	Unit	
1858 (0742h)	1859 (0743h)	Indirect reference area 33	This is an area to read/write from/to the parameter or command registered in the indirect reference address (33).	R/W	-	-	929 (03A1h)
1860 (0744h)	1861 (0745h)	Indirect reference area 34	This is an area to read/write from/to the parameter or command registered in the indirect reference address (34).	R/W	-	-	930 (03A2h)
1862 (0746h)	1863 (0747h)	Indirect reference area 35	This is an area to read/write from/to the parameter or command registered in the indirect reference address (35).	R/W	-	-	931 (03A3h)
1864 (0748h)	1865 (0749h)	Indirect reference area 36	This is an area to read/write from/to the parameter or command registered in the indirect reference address (36).	R/W	-	-	932 (03A4h)
1866 (074Ah)	1867 (074Bh)	Indirect reference area 37	This is an area to read/write from/to the parameter or command registered in the indirect reference address (37).	R/W	-	-	933 (03A5h)
1868 (074Ch)	1869 (074Dh)	Indirect reference area 38	This is an area to read/write from/to the parameter or command registered in the indirect reference address (38).	R/W	-	-	934 (03A6h)
1870 (074Eh)	1871 (074Fh)	Indirect reference area 39	This is an area to read/write from/to the parameter or command registered in the indirect reference address (39).	R/W	-	-	935 (03A7h)
1872 (0750h)	1873 (0751h)	Indirect reference area 40	This is an area to read/write from/to the parameter or command registered in the indirect reference address (40).	R/W	-	-	936 (03A8h)
1874 (0752h)	1875 (0753h)	Indirect reference area 41	This is an area to read/write from/to the parameter or command registered in the indirect reference address (41).	R/W	-	-	937 (03A9h)
1876 (0754h)	1877 (0755h)	Indirect reference area 42	This is an area to read/write from/to the parameter or command registered in the indirect reference address (42).	R/W	-	-	938 (03AAh)
1878 (0756h)	1879 (0757h)	Indirect reference area 43	This is an area to read/write from/to the parameter or command registered in the indirect reference address (43).	R/W	-	-	939 (03ABh)
1880 (0758h)	1881 (0759h)	Indirect reference area 44	This is an area to read/write from/to the parameter or command registered in the indirect reference address (44).	R/W	-	-	940 (03ACh)
1882 (075Ah)	1883 (075Bh)	Indirect reference area 45	This is an area to read/write from/to the parameter or command registered in the indirect reference address (45).	R/W	-	-	941 (03ADh)
1884 (075Ch)	1885 (075Dh)	Indirect reference area 46	This is an area to read/write from/to the parameter or command registered in the indirect reference address (46).	R/W	-	-	942 (03AEh)
1886 (075Eh)	1887 (075Fh)	Indirect reference area 47	This is an area to read/write from/to the parameter or command registered in the indirect reference address (47).	R/W	-	-	943 (03AFh)
1888 (0760h)	1889 (0761h)	Indirect reference area 48	This is an area to read/write from/to the parameter or command registered in the indirect reference address (48).	R/W	-	-	944 (03B0h)
1890 (0762h)	1891 (0763h)	Indirect reference area 49	This is an area to read/write from/to the parameter or command registered in the indirect reference address (49).	R/W	-	-	945 (03B1h)
1892 (0764h)	1893 (0765h)	Indirect reference area 50	This is an area to read/write from/to the parameter or command registered in the indirect reference address (50).	R/W	-	-	946 (03B2h)

Modbus communication register address		Name	Description	R/W	Initial setting		NET-ID
Upper	Lower				Initial value	Unit	
1894 (0766h)	1895 (0767h)	Indirect reference area 51	This is an area to read/write from/to the parameter or command registered in the indirect reference address (51).	R/W	-	-	947 (03B3h)
1896 (0768h)	1897 (0769h)	Indirect reference area 52	This is an area to read/write from/to the parameter or command registered in the indirect reference address (52).	R/W	-	-	948 (03B4h)
1898 (076Ah)	1899 (076Bh)	Indirect reference area 53	This is an area to read/write from/to the parameter or command registered in the indirect reference address (53).	R/W	-	-	949 (03B5h)
1900 (076Ch)	1901 (076Dh)	Indirect reference area 54	This is an area to read/write from/to the parameter or command registered in the indirect reference address (54).	R/W	-	-	950 (03B6h)
1902 (076Eh)	1903 (076Fh)	Indirect reference area 55	This is an area to read/write from/to the parameter or command registered in the indirect reference address (55).	R/W	-	-	951 (03B7h)
1904 (0770h)	1905 (0771h)	Indirect reference area 56	This is an area to read/write from/to the parameter or command registered in the indirect reference address (56).	R/W	-	-	952 (03B8h)
1906 (0772h)	1907 (0773h)	Indirect reference area 57	This is an area to read/write from/to the parameter or command registered in the indirect reference address (57).	R/W	-	-	953 (03B9h)
1908 (0774h)	1909 (0775h)	Indirect reference area 58	This is an area to read/write from/to the parameter or command registered in the indirect reference address (58).	R/W	-	-	954 (03BAh)
1910 (0776h)	1911 (0777h)	Indirect reference area 59	This is an area to read/write from/to the parameter or command registered in the indirect reference address (59).	R/W	-	-	955 (03BBh)
1912 (0778h)	1913 (0779h)	Indirect reference area 60	This is an area to read/write from/to the parameter or command registered in the indirect reference address (60).	R/W	-	-	956 (03BCh)
1914 (077Ah)	1915 (077Bh)	Indirect reference area 61	This is an area to read/write from/to the parameter or command registered in the indirect reference address (61).	R/W	-	-	957 (03BDh)
1916 (077Ch)	1917 (077Dh)	Indirect reference area 62	This is an area to read/write from/to the parameter or command registered in the indirect reference address (62).	R/W	-	-	958 (03BEh)
1918 (077Eh)	1919 (077Fh)	Indirect reference area 63	This is an area to read/write from/to the parameter or command registered in the indirect reference address (63).	R/W	-	-	959 (03BFh)
1920 (0780h)	1921 (0781h)	Indirect reference area 64	This is an area to read/write from/to the parameter or command registered in the indirect reference address (64).	R/W	-	-	960 (03C0h)
1922 (0782h)	1923 (0783h)	Indirect reference area 65	This is an area to read/write from/to the parameter or command registered in the indirect reference address (65).	R/W	-	-	961 (03C1h)
1924 (0784h)	1925 (0785h)	Indirect reference area 66	This is an area to read/write from/to the parameter or command registered in the indirect reference address (66).	R/W	-	-	962 (03C2h)
1926 (0786h)	1927 (0787h)	Indirect reference area 67	This is an area to read/write from/to the parameter or command registered in the indirect reference address (67).	R/W	-	-	963 (03C3h)
1928 (0788h)	1929 (0789h)	Indirect reference area 68	This is an area to read/write from/to the parameter or command registered in the indirect reference address (68).	R/W	-	-	964 (03C4h)

Modbus communication register address		Name	Description	R/W	Initial setting		NET-ID
Upper	Lower				Initial value	Unit	
1930 (078Ah)	1931 (078Bh)	Indirect reference area 69	This is an area to read/write from/to the parameter or command registered in the indirect reference address (69).	R/W	-	-	965 (03C5h)
1932 (078Ch)	1933 (078Dh)	Indirect reference area 70	This is an area to read/write from/to the parameter or command registered in the indirect reference address (70).	R/W	-	-	966 (03C6h)
1934 (078Eh)	1935 (078Fh)	Indirect reference area 71	This is an area to read/write from/to the parameter or command registered in the indirect reference address (71).	R/W	-	-	967 (03C7h)
1936 (0790h)	1937 (0791h)	Indirect reference area 72	This is an area to read/write from/to the parameter or command registered in the indirect reference address (72).	R/W	-	-	968 (03C8h)
1938 (0792h)	1939 (0793h)	Indirect reference area 73	This is an area to read/write from/to the parameter or command registered in the indirect reference address (73).	R/W	-	-	969 (03C9h)
1940 (0794h)	1941 (0795h)	Indirect reference area 74	This is an area to read/write from/to the parameter or command registered in the indirect reference address (74).	R/W	-	-	970 (03CAh)
1942 (0796h)	1943 (0797h)	Indirect reference area 75	This is an area to read/write from/to the parameter or command registered in the indirect reference address (75).	R/W	-	-	971 (03CBh)
1944 (0798h)	1945 (0799h)	Indirect reference area 76	This is an area to read/write from/to the parameter or command registered in the indirect reference address (76).	R/W	-	-	972 (03CCh)
1946 (079Ah)	1947 (079Bh)	Indirect reference area 77	This is an area to read/write from/to the parameter or command registered in the indirect reference address (77).	R/W	-	-	973 (03CDh)
1948 (079Ch)	1949 (079Dh)	Indirect reference area 78	This is an area to read/write from/to the parameter or command registered in the indirect reference address (78).	R/W	-	-	974 (03CEh)
1950 (079Eh)	1951 (079Fh)	Indirect reference area 79	This is an area to read/write from/to the parameter or command registered in the indirect reference address (79).	R/W	-	-	975 (03CFh)
1952 (07A0h)	1953 (07A1h)	Indirect reference area 80	This is an area to read/write from/to the parameter or command registered in the indirect reference address (80).	R/W	-	-	976 (03D0h)
1954 (07A2h)	1955 (07A3h)	Indirect reference area 81	This is an area to read/write from/to the parameter or command registered in the indirect reference address (81).	R/W	-	-	977 (03D1h)
1956 (07A4h)	1957 (07A5h)	Indirect reference area 82	This is an area to read/write from/to the parameter or command registered in the indirect reference address (82).	R/W	-	-	978 (03D2h)
1958 (07A6h)	1959 (07A7h)	Indirect reference area 83	This is an area to read/write from/to the parameter or command registered in the indirect reference address (83).	R/W	-	-	979 (03D3h)
1960 (07A8h)	1961 (07A9h)	Indirect reference area 84	This is an area to read/write from/to the parameter or command registered in the indirect reference address (84).	R/W	-	-	980 (03D4h)
1962 (07AAh)	1963 (07ABh)	Indirect reference area 85	This is an area to read/write from/to the parameter or command registered in the indirect reference address (85).	R/W	-	-	981 (03D5h)
1964 (07ACh)	1965 (07ADh)	Indirect reference area 86	This is an area to read/write from/to the parameter or command registered in the indirect reference address (86).	R/W	-	-	982 (03D6h)

Modbus communication register address		Name	Description	R/W	Initial setting		NET-ID
Upper	Lower				Initial value	Unit	
1966 (07AEh)	1967 (07AFh)	Indirect reference area 87	This is an area to read/write from/to the parameter or command registered in the indirect reference address (87).	R/W	-	-	983 (03D7h)
1968 (07B0h)	1969 (07B1h)	Indirect reference area 88	This is an area to read/write from/to the parameter or command registered in the indirect reference address (88).	R/W	-	-	984 (03D8h)
1970 (07B2h)	1971 (07B3h)	Indirect reference area 89	This is an area to read/write from/to the parameter or command registered in the indirect reference address (89).	R/W	-	-	985 (03D9h)
1972 (07B4h)	1973 (07B5h)	Indirect reference area 90	This is an area to read/write from/to the parameter or command registered in the indirect reference address (90).	R/W	-	-	986 (03DAh)
1974 (07B6h)	1975 (07B7h)	Indirect reference area 91	This is an area to read/write from/to the parameter or command registered in the indirect reference address (91).	R/W	-	-	987 (03DBh)
1976 (07B8h)	1977 (07B9h)	Indirect reference area 92	This is an area to read/write from/to the parameter or command registered in the indirect reference address (92).	R/W	-	-	988 (03DCh)
1978 (07BAh)	1979 (07BBh)	Indirect reference area 93	This is an area to read/write from/to the parameter or command registered in the indirect reference address (93).	R/W	-	-	989 (03DDh)
1980 (07BCh)	1981 (07BDh)	Indirect reference area 94	This is an area to read/write from/to the parameter or command registered in the indirect reference address (94).	R/W	-	-	990 (03DEh)
1982 (07BEh)	1983 (07BFh)	Indirect reference area 95	This is an area to read/write from/to the parameter or command registered in the indirect reference address (95).	R/W	-	-	991 (03DFh)
1984 (07C0h)	1985 (07C1h)	Indirect reference area 96	This is an area to read/write from/to the parameter or command registered in the indirect reference address (96).	R/W	-	-	992 (03E0h)
1986 (07C2h)	1987 (07C3h)	Indirect reference area 97	This is an area to read/write from/to the parameter or command registered in the indirect reference address (97).	R/W	-	-	993 (03E1h)
1988 (07C4h)	1989 (07C5h)	Indirect reference area 98	This is an area to read/write from/to the parameter or command registered in the indirect reference address (98).	R/W	-	-	994 (03E2h)
1990 (07C6h)	1991 (07C7h)	Indirect reference area 99	This is an area to read/write from/to the parameter or command registered in the indirect reference address (99).	R/W	-	-	995 (03E3h)
1992 (07C8h)	1993 (07C9h)	Indirect reference area 100	This is an area to read/write from/to the parameter or command registered in the indirect reference address (100).	R/W	-	-	996 (03E4h)
1994 (07CAh)	1995 (07CBh)	Indirect reference area 101	This is an area to read/write from/to the parameter or command registered in the indirect reference address (101).	R/W	-	-	997 (03E5h)
1996 (07CCh)	1997 (07CDh)	Indirect reference area 102	This is an area to read/write from/to the parameter or command registered in the indirect reference address (102).	R/W	-	-	998 (03E6h)
1998 (07CEh)	1999 (07CFh)	Indirect reference area 103	This is an area to read/write from/to the parameter or command registered in the indirect reference address (103).	R/W	-	-	999 (03E7h)
2000 (07D0h)	2001 (07D1h)	Indirect reference area 104	This is an area to read/write from/to the parameter or command registered in the indirect reference address (104).	R/W	-	-	1000 (03E8h)

Modbus communication register address		Name	Description	R/W	Initial setting		NET-ID
Upper	Lower				Initial value	Unit	
2002 (07D2h)	2003 (07D3h)	Indirect reference area 105	This is an area to read/write from/to the parameter or command registered in the indirect reference address (105).	R/W	-	-	1001 (03E9h)
2004 (07D4h)	2005 (07D5h)	Indirect reference area 106	This is an area to read/write from/to the parameter or command registered in the indirect reference address (106).	R/W	-	-	1002 (03EAh)
2006 (07D6h)	2007 (07D7h)	Indirect reference area 107	This is an area to read/write from/to the parameter or command registered in the indirect reference address (107).	R/W	-	-	1003 (03EBh)
2008 (07D8h)	2009 (07D9h)	Indirect reference area 108	This is an area to read/write from/to the parameter or command registered in the indirect reference address (108).	R/W	-	-	1004 (03ECh)
2010 (07DAh)	2011 (07DBh)	Indirect reference area 109	This is an area to read/write from/to the parameter or command registered in the indirect reference address (109).	R/W	-	-	1005 (03EDh)
2012 (07DCh)	2013 (07DDh)	Indirect reference area 110	This is an area to read/write from/to the parameter or command registered in the indirect reference address (110).	R/W	-	-	1006 (03EEh)
2014 (07DEh)	2015 (07DFh)	Indirect reference area 111	This is an area to read/write from/to the parameter or command registered in the indirect reference address (111).	R/W	-	-	1007 (03EFh)
2016 (07E0h)	2017 (07E1h)	Indirect reference area 112	This is an area to read/write from/to the parameter or command registered in the indirect reference address (112).	R/W	-	-	1008 (03F0h)
2018 (07E2h)	2019 (07E3h)	Indirect reference area 113	This is an area to read/write from/to the parameter or command registered in the indirect reference address (113).	R/W	-	-	1009 (03F1h)
2020 (07E4h)	2021 (07E5h)	Indirect reference area 114	This is an area to read/write from/to the parameter or command registered in the indirect reference address (114).	R/W	-	-	1010 (03F2h)
2022 (07E6h)	2023 (07E7h)	Indirect reference area 115	This is an area to read/write from/to the parameter or command registered in the indirect reference address (115).	R/W	-	-	1011 (03F3h)
2024 (07E8h)	2025 (07E9h)	Indirect reference area 116	This is an area to read/write from/to the parameter or command registered in the indirect reference address (116).	R/W	-	-	1012 (03F4h)
2026 (07EAh)	2027 (07EBh)	Indirect reference area 117	This is an area to read/write from/to the parameter or command registered in the indirect reference address (117).	R/W	-	-	1013 (03F5h)
2028 (07ECh)	2029 (07EDh)	Indirect reference area 118	This is an area to read/write from/to the parameter or command registered in the indirect reference address (118).	R/W	-	-	1014 (03F6h)
2030 (07EEh)	2031 (07EFh)	Indirect reference area 119	This is an area to read/write from/to the parameter or command registered in the indirect reference address (119).	R/W	-	-	1015 (03F7h)
2032 (07F0h)	2033 (07F1h)	Indirect reference area 120	This is an area to read/write from/to the parameter or command registered in the indirect reference address (120).	R/W	-	-	1016 (03F8h)
2034 (07F2h)	2035 (07F3h)	Indirect reference area 121	This is an area to read/write from/to the parameter or command registered in the indirect reference address (121).	R/W	-	-	1017 (03F9h)
2036 (07F4h)	2037 (07F5h)	Indirect reference area 122	This is an area to read/write from/to the parameter or command registered in the indirect reference address (122).	R/W	-	-	1018 (03FAh)

Modbus communication register address		Name	Description	R/W	Initial setting		NET-ID
Upper	Lower				Initial value	Unit	
2038 (07F6h)	2039 (07F7h)	Indirect reference area 123	This is an area to read/write from/to the parameter or command registered in the indirect reference address (123).	R/W	–	–	1019 (03FBh)
2040 (07F8h)	2041 (07F9h)	Indirect reference area 124	This is an area to read/write from/to the parameter or command registered in the indirect reference address (124).	R/W	–	–	1020 (03FCh)
2042 (07FAh)	2043 (07FBh)	Indirect reference area 125	This is an area to read/write from/to the parameter or command registered in the indirect reference address (125).	R/W	–	–	1021 (03FDh)
2044 (07FCh)	2045 (07FDh)	Indirect reference area 126	This is an area to read/write from/to the parameter or command registered in the indirect reference address (126).	R/W	–	–	1022 (03FEh)
2046 (07FEh)	2047 (07FFh)	Indirect reference area 127	This is an area to read/write from/to the parameter or command registered in the indirect reference address (127).	R/W	–	–	1023 (03FFh)

7 Modbus indirect reference commands (compatible)

These are commands used when indirect reference is performed via Modbus RTU communication. (For compatibility)
 This is a convenient input method when replacing from our existing product.
 The set value is stored in RAM. All commands can be read and written (READ/WRITE).

Modbus communication register address		Name	Description	R/W	Initial setting		NET-ID
Upper	Lower				Initial value	Unit	
4928 (1340h)	4929 (1341h)	Indirect reference area 0 (compatible)	This is an area to read/write from/to the parameter or command registered in the indirect reference address (0).	R/W	–	–	2464 (09A0h)
4930 (1342h)	4931 (1343h)	Indirect reference area 1 (compatible)	This is an area to read/write from/to the parameter or command registered in the indirect reference address (1).	R/W	–	–	2465 (09A1h)
4932 (1344h)	4933 (1345h)	Indirect reference area 2 (compatible)	This is an area to read/write from/to the parameter or command registered in the indirect reference address (2).	R/W	–	–	2466 (09A2h)
4934 (1346h)	4935 (1347h)	Indirect reference area 3 (compatible)	This is an area to read/write from/to the parameter or command registered in the indirect reference address (3).	R/W	–	–	2467 (09A3h)
4936 (1348h)	4937 (1349h)	Indirect reference area 4 (compatible)	This is an area to read/write from/to the parameter or command registered in the indirect reference address (4).	R/W	–	–	2468 (09A4h)
4938 (134Ah)	4939 (134Bh)	Indirect reference area 5 (compatible)	This is an area to read/write from/to the parameter or command registered in the indirect reference address (5).	R/W	–	–	2469 (09A5h)
4940 (134Ch)	4941 (134Dh)	Indirect reference area 6 (compatible)	This is an area to read/write from/to the parameter or command registered in the indirect reference address (6).	R/W	–	–	2470 (09A6h)
4942 (134Eh)	4943 (134Fh)	Indirect reference area 7 (compatible)	This is an area to read/write from/to the parameter or command registered in the indirect reference address (7).	R/W	–	–	2471 (09A7h)
4944 (1350h)	4945 (1351h)	Indirect reference area 8 (compatible)	This is an area to read/write from/to the parameter or command registered in the indirect reference address (8).	R/W	–	–	2472 (09A8h)
4946 (1352h)	4947 (1353h)	Indirect reference area 9 (compatible)	This is an area to read/write from/to the parameter or command registered in the indirect reference address (9).	R/W	–	–	2473 (09A9h)
4948 (1354h)	4949 (1355h)	Indirect reference area 10 (compatible)	This is an area to read/write from/to the parameter or command registered in the indirect reference address (10).	R/W	–	–	2474 (09AAh)
4950 (1356h)	4951 (1357h)	Indirect reference area 11 (compatible)	This is an area to read/write from/to the parameter or command registered in the indirect reference address (11).	R/W	–	–	2475 (09ABh)
4952 (1358h)	4953 (1359h)	Indirect reference area 12 (compatible)	This is an area to read/write from/to the parameter or command registered in the indirect reference address (12).	R/W	–	–	2476 (09ACh)
4954 (135Ah)	4955 (135Bh)	Indirect reference area 13 (compatible)	This is an area to read/write from/to the parameter or command registered in the indirect reference address (13).	R/W	–	–	2477 (09ADh)

Modbus communication register address		Name	Description	R/W	Initial setting		NET-ID
Upper	Lower				Initial value	Unit	
4956 (135Ch)	4957 (135Dh)	Indirect reference area 14 (compatible)	This is an area to read/write from/to the parameter or command registered in the indirect reference address (14).	R/W	-	-	2478 (09AEh)
4958 (135Eh)	4959 (135Fh)	Indirect reference area 15 (compatible)	This is an area to read/write from/to the parameter or command registered in the indirect reference address (15).	R/W	-	-	2479 (09AFh)
4960 (1360h)	4961 (1361h)	Indirect reference area 16 (compatible)	This is an area to read/write from/to the parameter or command registered in the indirect reference address (16).	R/W	-	-	2480 (09B0h)
4962 (1362h)	4963 (1363h)	Indirect reference area 17 (compatible)	This is an area to read/write from/to the parameter or command registered in the indirect reference address (17).	R/W	-	-	2481 (09B1h)
4964 (1364h)	4965 (1365h)	Indirect reference area 18 (compatible)	This is an area to read/write from/to the parameter or command registered in the indirect reference address (18).	R/W	-	-	2482 (09B2h)
4966 (1366h)	4967 (1367h)	Indirect reference area 19 (compatible)	This is an area to read/write from/to the parameter or command registered in the indirect reference address (19).	R/W	-	-	2483 (09B3h)
4968 (1368h)	4969 (1369h)	Indirect reference area 20 (compatible)	This is an area to read/write from/to the parameter or command registered in the indirect reference address (20).	R/W	-	-	2484 (09B4h)
4970 (136Ah)	4971 (136Bh)	Indirect reference area 21 (compatible)	This is an area to read/write from/to the parameter or command registered in the indirect reference address (21).	R/W	-	-	2485 (09B5h)
4972 (136Ch)	4973 (136Dh)	Indirect reference area 22 (compatible)	This is an area to read/write from/to the parameter or command registered in the indirect reference address (22).	R/W	-	-	2486 (09B6h)
4974 (136Eh)	4975 (136Fh)	Indirect reference area 23 (compatible)	This is an area to read/write from/to the parameter or command registered in the indirect reference address (23).	R/W	-	-	2487 (09B7h)
4976 (1370h)	4977 (1371h)	Indirect reference area 24 (compatible)	This is an area to read/write from/to the parameter or command registered in the indirect reference address (24).	R/W	-	-	2488 (09B8h)
4978 (1372h)	4979 (1373h)	Indirect reference area 25 (compatible)	This is an area to read/write from/to the parameter or command registered in the indirect reference address (25).	R/W	-	-	2489 (09B9h)
4980 (1374h)	4981 (1375h)	Indirect reference area 26 (compatible)	This is an area to read/write from/to the parameter or command registered in the indirect reference address (26).	R/W	-	-	2490 (09BAh)
4982 (1376h)	4983 (1377h)	Indirect reference area 27 (compatible)	This is an area to read/write from/to the parameter or command registered in the indirect reference address (27).	R/W	-	-	2491 (09BBh)
4984 (1378h)	4985 (1379h)	Indirect reference area 28 (compatible)	This is an area to read/write from/to the parameter or command registered in the indirect reference address (28).	R/W	-	-	2492 (09BCh)
4986 (137Ah)	4987 (137Bh)	Indirect reference area 29 (compatible)	This is an area to read/write from/to the parameter or command registered in the indirect reference address (29).	R/W	-	-	2493 (09BDh)
4988 (137Ch)	4989 (137Dh)	Indirect reference area 30 (compatible)	This is an area to read/write from/to the parameter or command registered in the indirect reference address (30).	R/W	-	-	2494 (09BEh)
4990 (137Eh)	4991 (137Fh)	Indirect reference area 31 (compatible)	This is an area to read/write from/to the parameter or command registered in the indirect reference address (31).	R/W	-	-	2495 (09BFh)

8 General purpose registers

These are commands to access the general registers. The set value is stored in RAM.
All commands can be read and written (READ/WRITE).

Modbus communication register address		Name	Description	R/W	Initial setting		NET-ID
Upper	Lower				Initial value	Unit	
2112 (0840h)	2113 (0841h)	General register 0	This is the general purpose register 0.	R/W	–	–	1056 (0420h)
2114 (0842h)	2115 (0843h)	General register 1	This is the general purpose register 1.	R/W	–	–	1057 (0421h)
2116 (0844h)	2117 (0845h)	General register 2	This is the general purpose register 2.	R/W	–	–	1058 (0422h)
2118 (0846h)	2119 (0847h)	General register 3	This is the general purpose register 3.	R/W	–	–	1059 (0423h)
2120 (0848h)	2121 (0849h)	General register 4	This is the general purpose register 4.	R/W	–	–	1060 (0424h)
2122 (084Ah)	2123 (084Bh)	General register 5	This is the general purpose register 5.	R/W	–	–	1061 (0425h)
2124 (084Ch)	2125 (084Dh)	General register 6	This is the general purpose register 6.	R/W	–	–	1062 (0426h)
2126 (084Eh)	2127 (084Fh)	General register 7	This is the general purpose register 7.	R/W	–	–	1063 (0427h)
2128 (0850h)	2129 (0851h)	General register 8	This is the general purpose register 8.	R/W	–	–	1064 (0428h)
2130 (0852h)	2131 (0853h)	General register 9	This is the general purpose register 9.	R/W	–	–	1065 (0429h)
2132 (0854h)	2133 (0855h)	General register 10	This is the general purpose register 10.	R/W	–	–	1066 (042Ah)
2134 (0856h)	2135 (0857h)	General register 11	This is the general purpose register 11.	R/W	–	–	1067 (042Bh)
2136 (0858h)	2137 (0859h)	General register 12	This is the general purpose register 12.	R/W	–	–	1068 (042Ch)
2138 (085Ah)	2139 (085Bh)	General register 13	This is the general purpose register 13.	R/W	–	–	1069 (042Dh)
2140 (085Ch)	2141 (085Dh)	General register 14	This is the general purpose register 14.	R/W	–	–	1070 (042Eh)
2142 (085Eh)	2143 (085Fh)	General register 15	This is the general purpose register 15.	R/W	–	–	1071 (042Fh)
2144 (0860h)	2145 (0861h)	General register 16	This is the general purpose register 16.	R/W	–	–	1072 (0430h)
2146 (0862h)	2147 (0863h)	General register 17	This is the general purpose register 17.	R/W	–	–	1073 (0431h)
2148 (0864h)	2149 (0865h)	General register 18	This is the general purpose register 18.	R/W	–	–	1074 (0432h)
2150 (0866h)	2151 (0867h)	General register 19	This is the general purpose register 19.	R/W	–	–	1075 (0433h)
2152 (0868h)	2153 (0869h)	General register 20	This is the general purpose register 20.	R/W	–	–	1076 (0434h)
2154 (086Ah)	2155 (086Bh)	General register 21	This is the general purpose register 21.	R/W	–	–	1077 (0435h)

General purpose registers

Modbus communication register address		Name	Description	R/W	Initial setting		NET-ID
Upper	Lower				Initial value	Unit	
2156 (086Ch)	2157 (086Dh)	General register 22	This is the general purpose register 22.	R/W	–	–	1078 (0436h)
2158 (086Eh)	2159 (086Fh)	General register 23	This is the general purpose register 23.	R/W	–	–	1079 (0437h)
2160 (0870h)	2161 (0871h)	General register 24	This is the general purpose register 24.	R/W	–	–	1080 (0438h)
2162 (0872h)	2163 (0873h)	General register 25	This is the general purpose register 25.	R/W	–	–	1081 (0439h)
2164 (0874h)	2165 (0875h)	General register 26	This is the general purpose register 26.	R/W	–	–	1082 (043Ah)
2166 (0876h)	2167 (0877h)	General register 27	This is the general purpose register 27.	R/W	–	–	1083 (043Bh)
2168 (0878h)	2169 (0879h)	General register 28	This is the general purpose register 28.	R/W	–	–	1084 (043Ch)
2170 (087Ah)	2171 (087Bh)	General register 29	This is the general purpose register 29.	R/W	–	–	1085 (043Dh)
2172 (087Ch)	2173 (087Dh)	General register 30	This is the general purpose register 30.	R/W	–	–	1086 (043Eh)
2174 (087Eh)	2175 (087Fh)	General register 31	This is the general purpose register 31.	R/W	–	–	1087 (043Fh)

9 Maintenance commands

Maintenance commands are used to execute resetting alarms, batch processing of the non-volatile memory or the like. All commands can be read and written (READ/WRITE).

Note The maintenance commands include processing in which the memory is operated, such as batch processing of the non-volatile memory. Be careful not to execute them unnecessarily in succession.

Modbus communication register address		Name	Description	R/W	Initial setting		NET-ID
Upper	Lower				Initial value	Unit	
384 (0180h)	385 (0181h)	Alarm reset	Resets the alarm being generated presently. Some alarms cannot be reset.	R/W	-	-	192 (00C0h)
388 (0184h)	389 (0185h)	Clear alarm history	Clears the alarm history.	R/W	-	-	194 (00C2h)
392 (0188h)	393 (0189h)	Clear communication error history	Clears the communication error history.	R/W	-	-	196 (00C4h)
394 (018Ah)	395 (018Bh)	P-PRESET execution	Presets the demand position.	R/W	-	-	197 (00C5h)
396 (018Ch)	397 (018Dh)	Configuration	Executes recalculation and setup of the parameter.	R/W	-	-	198 (00C6h)
398 (018Eh)	399 (018Fh)	Batch data initialization (excluding communication parameters)	Resets the parameters stored in the non-volatile memory to their initial values. (Excluding parameters related to communication setting)	R/W	-	-	199 (00C7h)
400 (0190h)	401 (0191h)	Read batch NV memory	Reads the parameters stored in the non-volatile memory to RAM. All operation data and parameters stored in RAM are overwritten.	R/W	-	-	200 (00C8h)
402 (0192h)	403 (0193h)	Write batch NV memory	Writes the parameters stored in RAM to the non-volatile memory. The non-volatile memory can be rewritten approximately 100,000 times.	R/W	-	-	201 (00C9h)
404 (0194h)	405 (0195h)	All data batch initialization (including communication parameters)	Resets all the parameters stored in the non-volatile memory to their initial values.	R/W	-	-	202 (00CAh)
410 (019Ah)	411 (019Bh)	Clear latch information	Clear the latch information.	R/W	-	-	205 (00CDh)
412 (019Ch)	413 (019Dh)	Clear sequence history	Clears the sequence history.	R/W	-	-	206 (00CEh)
414 (019Eh)	415 (019Fh)	Clear tripmeter 0/1	Clears the tripmeter 0 and the tripmeter 1.	R/W	-	-	207 (00CFh)
416 (01A0h)	417 (01A1h)	Clear ETO	Releases the ETO status.	R/W	-	-	208 (00D0h)
418 (01A2h)	419 (01A3h)	ZSG-PRESET	Sets the position of the ZSG-N output again.	R/W	-	-	209 (00D1h)
420 (01A4h)	421 (01A5h)	Clear ZSG-PRESET	Clears the position data of the ZSG-N output that was set again with the "ZSG-PRESET command."	R/W	-	-	210 (00D2h)
422 (01A6h)	423 (01A7h)	Clear information	Clears the information.	R/W	-	-	211 (00D3h)
424 (01A8h)	425 (01A9h)	Clear information history	Clears the information history.	R/W	-	-	212 (00D4h)

Modbus communication register address		Name	Description	R/W	Initial setting		NET-ID
Upper	Lower				Initial value	Unit	
428 (01ACh)	429 (01ADh)	Clear user energy consumption	Clears the user energy consumption.	R/W	–	–	214 (00D6h)
430 (01AEh)	431 (01AFh)	Clear tripmeter 0	Clears the tripmeter 0.	R/W	–	–	215 (00D7h)
432 (01B0h)	433 (01B1h)	Clear tripmeter 1	Clears the tripmeter 1.	R/W	–	–	216 (00D8h)
444 (01BCh)	445 (01BDh)	Reset communication	Resets the communication.	R/W	–	–	222 (00DEh)
446 (01BEh)	447 (01BFh)	Stop operation	Stops the operation. [Setting range] 1: Immediate stop 2: Deceleration rate stop (according to the operation profile during operation) 3: Follow QSTOP setting (current is not cut off) 4: Follow STOP setting	R/W	–	–	223 (00DFh)

9-1 How to execute the maintenance commands

■ To execute via Modbus communication

Reading or writing data can be executed. There are two types of execution methods. Use them selectively in accordance with the intended use.

● Write "1" to data (Recommended)

Write "1" to data, and when the data changes from "0" to "1," the command is executed.

When executing the same command again, once return to "0," and write "1." It can be used with safety because the command is not executed consecutively even if "1" is continued to write from the master.

● Write "2" to data

If "2" is written to data, the command is executed. It will automatically return to "1" after the execution. The data can be written consecutively because of no need to be returned to "1."

If commands which take time to write to the non-volatile memory such as "Write batch NV memory" command are executed consecutively, increase the length of the intervals between commands.



In the case of the stop operation, writing a value according to the stopping method executes the command. The value will automatically return to "0" after executed.

9-2 Reset communication

If the maintenance command "Reset communication" is executed, the re-setup of the parameters related to communication is performed after reading the signal status of the ID-SEL0 to ID-SEL3 inputs.

Parameters for which re-setup is performed

- RS-485 communication termination resistor
- Slave address (Modbus)
- Baudrate (Modbus)
- Byte & word order (Modbus)
- Communication parity (Modbus)
- Communication stop bit (Modbus)
- Transmission waiting time (Modbus)
- Silent interval (Modbus)
- CANopen Node-ID
- CANopen Bitrate

10 Monitor commands

These commands are used to monitor the demand position, demand velocity, alarm and information history, etc. All commands are used for read (READ).

Modbus communication register address		Name	Description	R/W	Initial setting		NET-ID	
Upper	Lower				Initial value	Unit		
128 (0080h)	129 (0081h)	Present alarm	Indicates the alarm code presently being generated.	R	–	–	64 (0040h)	
130 (0082h)	131 (0083h)	Alarm history 1	Indicates the latest alarm history. When an alarm is present, the code is also indicated in the alarm history 1.	R	–	–	65 (0041h)	
132 (0084h)	133 (0085h)	Alarm history 2	Indicates the alarm history.	R	–	–	66 (0042h)	
134 (0086h)	135 (0087h)	Alarm history 3		R	–	–	67 (0043h)	
136 (0088h)	137 (0089h)	Alarm history 4		R	–	–	68 (0044h)	
138 (008Ah)	139 (008Bh)	Alarm history 5		R	–	–	69 (0045h)	
140 (008Ch)	141 (008Dh)	Alarm history 6		R	–	–	70 (0046h)	
142 (008Eh)	143 (008Fh)	Alarm history 7		R	–	–	71 (0047h)	
144 (0090h)	145 (0091h)	Alarm history 8		R	–	–	72 (0048h)	
146 (0092h)	147 (0093h)	Alarm history 9		R	–	–	73 (0049h)	
148 (0094h)	149 (0095h)	Alarm history 10		Indicates the oldest alarm history.	R	–	–	74 (004Ah)
150 (0096h)	151 (0097h)	Target position (User-defined position unit)		Indicates the present target position. (User-defined position unit)	R	–	step	75 (004Bh)
152 (0098h)	153 (0099h)	Demand position (User-defined position unit)	Indicates the present demand position. (User-defined position unit)	R	–	step	76 (004Ch)	
154 (009Ah)	155 (009Bh)	Actual position (User-defined position unit)	Indicates the present actual position. (User-defined position unit)	R	–	step	77 (004Dh)	
156 (009Ch)	157 (009Dh)	Target velocity (User-defined velocity unit)	Indicates the present target velocity. (User-defined velocity unit)	R	–	r/min	78 (004Eh)	
158 (009Eh)	159 (009Fh)	Demand velocity (User-defined velocity unit)	Indicates the present demand velocity. (User-defined velocity unit)	R	–	r/min	79 (004Fh)	
160 (00A0h)	161 (00A1h)	Actual velocity (User-defined velocity unit)	Indicates the present actual velocity. (User-defined velocity unit)	R	–	r/min	80 (0050h)	
172 (00ACh)	173 (00ADh)	Present communication error	Indicates the communication error code received last time.	R	–	–	86 (0056h)	

Modbus communication register address		Name	Description	R/W	Initial setting		NET-ID
Upper	Lower				Initial value	Unit	
174 (00AEh)	175 (00AFh)	Communication error history 1	Indicates the latest communication error code history. When a communication error is present, the code is also indicated in the communication error history 1 at the same time.	R	–	–	87 (0057h)
176 (00B0h)	177 (00B1h)	Communication error history 2	Indicates the communication error code history.	R	–	–	88 (0058h)
178 (00B2h)	179 (00B3h)	Communication error history 3		R	–	–	89 (0059h)
180 (00B4h)	181 (00B5h)	Communication error history 4		R	–	–	90 (005Ah)
182 (00B6h)	183 (00B7h)	Communication error history 5		R	–	–	91 (005Bh)
184 (00B8h)	185 (00B9h)	Communication error history 6		R	–	–	92 (005Ch)
186 (00BAh)	187 (00BBh)	Communication error history 7		R	–	–	93 (005Dh)
188 (00BCh)	189 (00BDh)	Communication error history 8		R	–	–	94 (005Eh)
190 (00BEh)	191 (00BFh)	Communication error history 9		R	–	–	95 (005Fh)
192 (00C0h)	193 (00C1h)	Communication error history 10		Indicates the oldest communication error code history.	R	–	–
194 (00C2h)	195 (00C3h)	Present selected data number	Indicates the operation data number presently selected. The priority is in order of the NET selection number, the direct selection (D-SEL), and the M0 to M7 inputs.	R	–	–	97 (0061h)
196 (00C4h)	197 (00C5h)	Present operation data number	Indicates the operation data number presently being operated in stored data operation or continuous operation. In operation without using operation data, –1 is displayed. –1 is displayed also during stop.	R	–	–	98 (0062h)
198 (00C6h)	199 (00C7h)	Demand position (step)	Indicates the present demand position. (step)	R	–	step	99 (0063h)
200 (00C8h)	201 (00C9h)	Demand velocity (r/min)	Indicates the present demand velocity. (r/min)	R	–	r/min	100 (0064h)
202 (00CAh)	203 (00CBh)	Demand velocity (step/s)	Indicates the present demand velocity. (step/s)	R	–	step/s	101 (0065h)
204 (00CCh)	205 (00CDh)	Actual position (step)	Indicates the present actual position. (step)	R	–	step	102 (0066h)
206 (00CEh)	207 (00CFh)	Actual velocity (r/min)	Indicates the present actual velocity. (r/min)	R	–	r/min	103 (0067h)
208 (00D0h)	209 (00D1h)	Actual velocity (step/s)	Indicates the present actual velocity. (step/s)	R	–	step/s	104 (0068h)
210 (00D2h)	211 (00D3h)	Remaining dwell time	Indicates the remaining time in the drive-complete delay time or dwell. (ms)	R	–	ms	105 (0069h)
212 (00D4h)	213 (00D5h)	Direct I/O	Indicates the status of direct I/O. (Arrangement of bits ⇨ p.335)	R	–	–	106 (006Ah)

Modbus communication register address		Name	Description	R/W	Initial setting		NET-ID
Upper	Lower				Initial value	Unit	
214 (00D6h)	215 (00D7h)	Torque monitor	Indicates the output torque presently generated as a percentage of the rated torque.	R	–	1=0.1%	107 (006Bh)
216 (00D8h)	217 (00D9h)	Load factor monitor	Indicates the output torque presently generated as a percentage of the maximum torque in the continuous duty region.	R	–	1=0.1%	108 (006Ch)
218 (00DAh)	219 (00DBh)	Cumulative load monitor	Indicates the integrated value of the load during operation. (Internal unit) The load is accumulated regardless of the rotation direction of the motor. (Details of cumulative load monitor → p.475)	R	–	–	109 (006Dh)
220 (00DCh)	221 (00DDh)	Torque limiting value	Indicates the present torque limiting value. (1=0.1%)	R	–	1=0.1%	110 (006Eh)
224 (00E0h)	225 (00E1h)	Next data number	Indicates the operation data number specified in "Next data number" of the operation data in operation. The value is latched even after the operation is completed. When "Link" is set to "No Link" or "Next data number" is set to "Stop," –1 is displayed.	R	–	–	112 (0070h)
226 (00E2h)	227 (00E3h)	Loop origin data number	Indicates the operation data number that is the starting point of the loop in loop operation. When loop is not executed or stopped, –1 is displayed.	R	–	–	113 (0071h)
228 (00E4h)	229 (00E5h)	Loop count	Indicates the present number of loop times in loop operation. When operation other than loop is executed or loop is stopped, 0 is displayed.	R	–	–	114 (0072h)
230 (00E6h)	231 (00E7h)	Position deviation	Indicates the deviation between the demand position and the actual position. (User-defined position unit)	R	–	step	115 (0073h)
232 (00E8h)	233 (00E9h)	Position deviation in controller	Indicates the deviation between the demand position having input to the position controller and the actual position. (User-defined position unit)	R	–	step	116 (0074h)
234 (00EAh)	235 (00EBh)	Speed deviation	Indicates the deviation between the demand velocity and the actual velocity. (User-defined velocity unit)	R	–	r/min	117 (0075h)
236 (00ECh)	237 (00EDh)	Speed deviation in controller	Indicates the deviation between the demand velocity having input to the speed controller and the actual velocity. (User-defined velocity unit)	R	–	r/min	118 (0076h)
238 (00EEh)	239 (00EFh)	Settling time	Indicates the time from when the command is completed until the IN-POS output is turned ON. (ms)	R	–	ms	119 (0077h)
244 (00F4h)	245 (00F5h)	Tripmeter 1 (1=0.1 kRev)	Indicates the travel distance of the motor in revolutions. (1=0.1 krev) This can be cleared on the customer side.	R	–	1=0.1 krev	122 (007Ah)
246 (00F6h)	247 (00F7h)	Information status 1	Indicates the information status presently being generated.	R	–	–	123 (007Bh)
248 (00F8h)	249 (00F9h)	Driver temperature	Indicates the present driver temperature. (1=0.1 °C)	R	–	1=0.1 °C	124 (007Ch)

Modbus communication register address		Name	Description	R/W	Initial setting		NET-ID	
Upper	Lower				Initial value	Unit		
250 (00FAh)	251 (00FBh)	Motor temperature	Indicates the present motor temperature. (1=0.1 °C)	R	–	1=0.1 °C	125 (007Dh)	
252 (00FCh)	253 (00FDh)	Odometer	Indicates the cumulative travel distance of the motor in revolutions. (1=0.1 krev) This cannot be cleared on the customer side.	R	–	1=0.1 krev	126 (007Eh)	
254 (00FEh)	255 (00FFh)	Tripmeter 0	Indicates the travel distance of the motor in revolutions. (1=0.1 krev) This can be cleared on the customer side.	R	–	1=0.1 krev	127 (007Fh)	
256 (0100h)	257 (0101h)	Sequence history 1	Indicates the history of operation data numbers executed until now. –1 is always displayed when stopped. During operation, the value same as the "Present operation data number" is also displayed in the sequence history 1.	R	–	–	128 (0080h)	
258 (0102h)	259 (0103h)	Sequence history 2	Indicates the history of operation data numbers executed until now. –1 is always displayed when stopped.	R	–	–	129 (0081h)	
260 (0104h)	261 (0105h)	Sequence history 3		R	–	–	130 (0082h)	
262 (0106h)	263 (0107h)	Sequence history 4		R	–	–	131 (0083h)	
264 (0108h)	265 (0109h)	Sequence history 5		R	–	–	132 (0084h)	
266 (010Ah)	267 (010Bh)	Sequence history 6		R	–	–	133 (0085h)	
268 (010Ch)	269 (010Dh)	Sequence history 7		R	–	–	134 (0086h)	
270 (010Eh)	271 (010Fh)	Sequence history 8		R	–	–	135 (0087h)	
272 (0110h)	273 (0111h)	Sequence history 9		R	–	–	136 (0088h)	
274 (0112h)	275 (0113h)	Sequence history 10		R	–	–	137 (0089h)	
276 (0114h)	277 (0115h)	Sequence history 11		R	–	–	138 (008Ah)	
278 (0116h)	279 (0117h)	Sequence history 12		R	–	–	139 (008Bh)	
280 (0118h)	281 (0119h)	Sequence history 13		R	–	–	140 (008Ch)	
282 (011Ah)	283 (011Bh)	Sequence history 14		R	–	–	141 (008Dh)	
284 (011Ch)	285 (011Dh)	Sequence history 15		R	–	–	142 (008Eh)	
286 (011Eh)	287 (011Fh)	Sequence history 16		Indicates the oldest operation data number among the data executed until now. –1 is always displayed when stopped.	R	–	–	143 (008Fh)
288 (0120h)	289 (0121h)	Actual position 32-bit counter (User-defined position unit)		This is the actual position 32-bit counter. Counts independently of the WRAP function.	R	–	step	144 (0090h)

Modbus communication register address		Name	Description	R/W	Initial setting		NET-ID
Upper	Lower				Initial value	Unit	
290 (0122h)	291 (0123h)	Demand position 32-bit counter (User-defined position unit)	This is the demand position 32-bit counter. Counts independently of the WRAP function.	R	–	step	145 (0091h)
294 (0126h)	295 (0127h)	Loop count buffer	Indicates the present number of loop times in loop operation. The value is kept until the operation start signal is turned ON.	R	–	–	147 (0093h)
300 (012Ch)	301 (012Dh)	Corrected max software limit	Indicates the maximum value of the software limit.	R	–	step	150 (0096h)
302 (012Eh)	303 (012Fh)	Corrected min software limit	Indicates the minimum value of the software limit.	R	–	step	151 (0097h)
310 (0136h)	311 (0137h)	Main power supply current	Indicates the present current value of the main power supply. (1=0.001 A)	R	–	1=0.001 A	155 (009Bh)
312 (0138h)	313 (0139h)	Power consumption	Indicates the present power consumption. (1=0.1 W)	R	–	1=0.1W	156 (009Ch)
314 (013Ah)	315 (013Bh)	Energy consumption	Indicates the present energy consumption. (1=0.001 Wh)	R	–	1=0.001 Wh	157 (009Dh)
316 (013Ch)	317 (013Dh)	User energy consumption	Indicates the total energy consumption. (Wh) This can be cleared on the customer side.	R	–	Wh	158 (009Eh)
318 (013Eh)	319 (013Fh)	Total energy consumption	Indicates the total energy consumption. (Wh) This cannot be cleared on the customer side.	R	–	Wh	159 (009Fh)
322 (0142h)	323 (0143h)	Total uptime	Indicates the total time that has elapsed since the main power supply was turned on. (min)	R	–	min	161 (00A1h)
324 (0144h)	325 (0145h)	Number of boots	Indicates the total number of times that the driver was started.	R	–	–	162 (00A2h)
326 (0146h)	327 (0147h)	Inverter voltage	Indicates the inverter voltage of the driver. (1=0.1 V)	R	–	1=0.1V	163 (00A3h)
328 (0148h)	329 (0149h)	Main power supply voltage	Indicates the main power supply voltage. (1=0.1 V)	R	–	1=0.1V	164 (00A4h)
338 (0152h)	339 (0153h)	Continuous uptime	Indicates the time at which the main power supply is supplied continuously. (ms)	R	–	ms	169 (00A9h)
340 (0154h)	341 (0155h)	RS-485 communication reception byte counter	Indicates the number of bytes received.	R	–	–	170 (00AAh)
342 (0156h)	343 (0157h)	RS-485 communication transmission byte counter	Indicates the number of bytes transmitted.	R	–	–	171 (00ABh)
344 (0158h)	345 (0159h)	RS-485 communication normal reception frame counter (All)	Indicates the number of normal frames received.	R	–	–	172 (00ACh)
346 (015Ah)	347 (015Bh)	RS-485 communication normal reception frame counter (Only own address)	Indicates the number of normal frames received to own address.	R	–	–	173 (00ADh)
348 (015Ch)	349 (015Dh)	RS-485 communication Abnormal reception frame counter (All)	Indicates the number of abnormal frames received.	R	–	–	174 (00AEh)

Modbus communication register address		Name	Description	R/W	Initial setting		NET-ID
Upper	Lower				Initial value	Unit	
350 (015Eh)	351 (015Fh)	RS-485 communication transmission frame counter	Indicates the number of frames transmitted.	R	–	–	175 (00AFh)
352 (0160h)	353 (0161h)	RS-485 communication register write error counter	Indicates the number of times the register write error occurred.	R	–	–	176 (00B0h)
354 (0162h)	355 (0163h)	RS-485 communication valid frame/second	Indicates the number of valid frames per second.	R	–	–	177 (00B1h)
356 (0164h)	357 (0165h)	RS-485 communication processing time	Indicates the communication processing time for RS-485 communication.	R	–	ms	178 (00B2h)
358 (0166h)	359 (0167h)	RS-485 communication maximum processing time	Indicates the maximum communication processing time after turning on the power.	R	–	ms	179 (00B3h)
360 (0168h)	361 (0169h)	RS-485 communication interval	Indicates the communication interval for RS-485 communication.	R	–	ms	180 (00B4h)
362 (016Ah)	363 (016Bh)	RS-485 communication maximum interval	Indicates the maximum communication interval for RS-485 communication.	R	–	ms	181 (00B5h)
368 (0170h)	369 (0171h)	I/O status 1	Indicates the ON-OFF status of the internal I/O. (Arrangement of bits ⇨ p.336)	R	–	–	184 (00B8h)
370 (0172h)	371 (0173h)	I/O status 2		R	–	–	185 (00B9h)
372 (0174h)	373 (0175h)	I/O status 3		R	–	–	186 (00BAh)
374 (0176h)	375 (0177h)	I/O status 4		R	–	–	187 (00BBh)
376 (0178h)	377 (0179h)	I/O status 5		R	–	–	188 (00BCh)
378 (017Ah)	379 (017Bh)	I/O status 6		R	–	–	189 (00BDh)
380 (017Ch)	381 (017Dh)	I/O status 7		R	–	–	190 (00BEh)
382 (017Eh)	383 (017Fh)	I/O status 8		R	–	–	191 (00BFh)
2624 (0A40h)	2625 (0A41h)	Information time history 1	Indicates the history of the time when the latest information was generated. When information is present, the time when the present information was generated is indicated. (ms)	R	–	ms	1312 (0520h)
2626 (0A42h)	2627 (0A43h)	Information time history 2	Indicates the history of the time when information was generated. (ms)	R	–	ms	1313 (0521h)
2628 (0A44h)	2629 (0A45h)	Information time history 3		R	–	ms	1314 (0522h)
2630 (0A46h)	2631 (0A47h)	Information time history 4		R	–	ms	1315 (0523h)
2632 (0A48h)	2633 (0A49h)	Information time history 5		R	–	ms	1316 (0524h)
2634 (0A4Ah)	2635 (0A4Bh)	Information time history 6		R	–	ms	1317 (0525h)

Modbus communication register address		Name	Description	R/W	Initial setting		NET-ID
Upper	Lower				Initial value	Unit	
2636 (0A4Ch)	2637 (0A4Dh)	Information time history 7	Indicates the history of the time when information was generated. (ms)	R	–	ms	1318 (0526h)
2638 (0A4Eh)	2639 (0A4Fh)	Information time history 8		R	–	ms	1319 (0527h)
2640 (0A50h)	2641 (0A51h)	Information time history 9		R	–	ms	1320 (0528h)
2642 (0A52h)	2643 (0A53h)	Information time history 10		R	–	ms	1321 (0529h)
2644 (0A54h)	2645 (0A55h)	Information time history 11		R	–	ms	1322 (052Ah)
2646 (0A56h)	2647 (0A57h)	Information time history 12		R	–	ms	1323 (052Bh)
2648 (0A58h)	2649 (0A59h)	Information time history 13		R	–	ms	1324 (052Ch)
2650 (0A5Ah)	2651 (0A5Bh)	Information time history 14		R	–	ms	1325 (052Dh)
2652 (0A5Ch)	2653 (0A5Dh)	Information time history 15		R	–	ms	1326 (052Eh)
2654 (0A5Eh)	2655 (0A5Fh)	Information time history 16		Indicates the history of the time when the oldest information was generated. (ms)	R	–	ms
2656 (0A60h)	2657 (0A61h)	Information history 1	Indicates the latest information history. If information is present, the information status is also indicated on the information history 1. (Arrangement of bits ⇨ p.333)	R	–	–	1328 (0530h)
2658 (0A62h)	2659 (0A63h)			R			1329 (0531h)
2660 (0A64h)	2661 (0A65h)			R			1330 (0532h)
2662 (0A66h)	2663 (0A67h)			R			1331 (0533h)
2664 (0A68h)	2665 (0A69h)	Information history 2	Indicates the information history. (Arrangement of bits ⇨ p.333)	R	–	–	1332 (0534h)
2666 (0A6Ah)	2667 (0A6Bh)			R			1333 (0535h)
2668 (0A6Ch)	2669 (0A6Dh)			R			1334 (0536h)
2670 (0A6Eh)	2671 (0A6Fh)			R			1335 (0537h)
2672 (0A70h)	2673 (0A71h)	Information history 3	Indicates the information history. (Arrangement of bits ⇨ p.333)	R	–	–	1336 (0538h)
2674 (0A72h)	2675 (0A73h)			R			1337 (0539h)
2676 (0A74h)	2677 (0A75h)			R			1338 (053Ah)
2678 (0A76h)	2679 (0A77h)			R			1339 (053Bh)

Modbus communication register address		Name	Description	R/W	Initial setting		NET-ID
Upper	Lower				Initial value	Unit	
2680 (0A78h)	2681 (0A79h)	Information history 4	Indicates the information history. (Arrangement of bits ⇨ p.333)	R			1340 (053Ch)
2682 (0A7Ah)	2683 (0A7Bh)			R			1341 (053Dh)
2684 (0A7Ch)	2685 (0A7Dh)			R	-	-	1342 (053Eh)
2686 (0A7Eh)	2687 (0A7Fh)			R			1343 (053Fh)
2688 (0A80h)	2689 (0A81h)	Information history 5		R			1344 (0540h)
2690 (0A82h)	2691 (0A83h)			R			1345 (0541h)
2692 (0A84h)	2693 (0A85h)			R	-	-	1346 (0542h)
2694 (0A86h)	2695 (0A87h)			R			1347 (0543h)
2696 (0A88h)	2697 (0A89h)	Information history 6		R			1348 (0544h)
2698 (0A8Ah)	2699 (0A8Bh)			R			1349 (0545h)
2700 (0A8Ch)	2701 (0A8Dh)			R	-	-	1350 (0546h)
2702 (0A8Eh)	2703 (0A8Fh)			R			1351 (0547h)
2704 (0A90h)	2705 (0A91h)	Information history 7		R			1352 (0548h)
2706 (0A92h)	2707 (0A93h)			R			1353 (0549h)
2708 (0A94h)	2709 (0A95h)			R	-	-	1354 (054Ah)
2710 (0A96h)	2711 (0A97h)			R			1355 (054Bh)
2712 (0A98h)	2713 (0A99h)	Information history 8	R			1356 (054Ch)	
2714 (0A9Ah)	2715 (0A9Bh)		R			1357 (054Dh)	
2716 (0A9Ch)	2717 (0A9Dh)		R	-	-	1358 (054Eh)	
2718 (0A9Eh)	2719 (0A9Fh)		R			1359 (054Fh)	
2720 (0AA0h)	2721 (0AA1h)	Information history 9	R			1360 (0550h)	
2722 (0AA2h)	2723 (0AA3h)		R			1361 (0551h)	
2724 (0AA4h)	2725 (0AA5h)		R	-	-	1362 (0552h)	
2726 (0AA6h)	2727 (0AA7h)		R			1363 (0553h)	

Modbus communication register address		Name	Description	R/W	Initial setting		NET-ID
Upper	Lower				Initial value	Unit	
2728 (0AA8h)	2729 (0AA9h)	Information history 10	Indicates the information history. (Arrangement of bits ⇨ p.333)	R	-	-	1364 (0554h)
2730 (0AAAh)	2731 (0AABh)			R			1365 (0555h)
2732 (0AACCh)	2733 (0AADh)			R			1366 (0556h)
2734 (0AAEh)	2735 (0AAFh)			R			1367 (0557h)
2736 (0AB0h)	2737 (0AB1h)	Information history 11		R	-	-	1368 (0558h)
2738 (0AB2h)	2739 (0AB3h)			R			1369 (0559h)
2740 (0AB4h)	2741 (0AB5h)			R			1370 (055Ah)
2742 (0AB6h)	2743 (0AB7h)			R			1371 (055Bh)
2744 (0AB8h)	2745 (0AB9h)	Information history 12		R	-	-	1372 (055Ch)
2746 (0ABAh)	2747 (0ABBh)			R			1373 (055Dh)
2748 (0ABCh)	2749 (0ABDh)			R			1374 (055Eh)
2750 (0ABEh)	2751 (0ABFh)			R			1375 (055Fh)
2752 (0AC0h)	2753 (0AC1h)	Information history 13		R	-	-	1376 (0560h)
2754 (0AC2h)	2755 (0AC3h)			R			1377 (0561h)
2756 (0AC4h)	2757 (0AC5h)			R			1378 (0562h)
2758 (0AC6h)	2759 (0AC7h)		R	1379 (0563h)			
2760 (0AC8h)	2761 (0AC9h)	Information history 14	R	-	-	1380 (0564h)	
2762 (0ACAh)	2763 (0ACBh)		R			1381 (0565h)	
2764 (0ACCh)	2765 (0ACDh)		R			1382 (0566h)	
2766 (0ACEh)	2767 (0ACFh)		R			1383 (0567h)	
2768 (0AD0h)	2769 (0AD1h)	Information history 15	R	-	-	1384 (0568h)	
2770 (0AD2h)	2771 (0AD3h)		R			1385 (0569h)	
2772 (0AD4h)	2773 (0AD5h)		R			1386 (056Ah)	
2774 (0AD6h)	2775 (0AD7h)		R			1387 (056Bh)	

Modbus communication register address		Name	Description	R/W	Initial setting		NET-ID
Upper	Lower				Initial value	Unit	
2776 (0AD8h)	2777 (0AD9h)	Information history 16	Indicates the oldest information history. (Arrangement of bits ⇨ p.333)	R	-	-	1388 (056Ch)
2778 (0ADAh)	2779 (0ADBh)			R			1389 (056Dh)
2780 (0ADCh)	2781 (0ADDh)			R			1390 (056Eh)
2782 (0ADEh)	2783 (0ADFh)			R			1391 (056Fh)
2784 (0AE0h)	2785 (0AE1h)	Information status	Indicates the information status presently being generated. (Arrangement of bits ⇨ p.334)	R	-	-	1392 (0570h)
2786 (0AE2h)	2787 (0AE3h)			R			1393 (0571h)
2788 (0AE4h)	2789 (0AE5h)			R			1394 (0572h)
2790 (0AE6h)	2791 (0AE7h)			R			1395 (0573h)
2792 (0AE8h)	2793 (0AE9h)	Information count	Indicates the number of times that information was generated.	R	-	-	1396 (0574h)
2816 (0B00h)	2817 (0B01h)	Latch monitor status (USR-LAT0: POS-EDGE)	Indicates the status of the latch by the USR-LAT0 input (positive edge).	R	-	-	1408 (0580h)
2818 (0B02h)	2819 (0B03h)	Latch monitor demand position (USR-LAT0: POS-EDGE)	Indicates the demand position latched by the USR-LAT0 input (positive edge).	R	-	step	1409 (0581h)
2820 (0B04h)	2821 (0B05h)	Latch monitor actual position (USR-LAT0: POS-EDGE)	Indicates the actual position latched by the USR-LAT0 input (positive edge).	R	-	step	1410 (0582h)
2822 (0B06h)	2823 (0B07h)	Latch monitor target position (USR-LAT0: POS-EDGE)	Indicates the target position latched by the USR-LAT0 input (positive edge).	R	-	step	1411 (0583h)
2824 (0B08h)	2825 (0B09h)	Latch monitor operation number (USR-LAT0: POS-EDGE)	Indicates the operation number latched by the USR-LAT0 input (positive edge).	R	-	-	1412 (0584h)
2826 (0B0Ah)	2827 (0B0Bh)	Latch monitor number of loop (USR-LAT0: POS-EDGE)	Indicates the number of loop times latched by the USR-LAT0 input (positive edge).	R	-	-	1413 (0585h)
2828 (0B0Ch)	2829 (0B0Dh)	Latch monitor number of latch (USR-LAT0: POS-EDGE)	Indicates the number of times latched by the USR-LAT0 input (positive edge).	R	-	-	1414 (0586h)
2830 (0B0Eh)	2831 (0B0Fh)	Latch monitor number of continuous uptime (USR-LAT0: POS-EDGE)	Indicates the number of continuous uptime latched by the USR-LAT0 input (positive edge).	R	-	ms	1415 (0587h)
2832 (0B10h)	2833 (0B11h)	Latch monitor status (USR-LAT0: NEG-EDGE)	Indicates the status of the latch by the USR-LAT0 input (negative edge).	R	-	-	1416 (0588h)
2834 (0B12h)	2835 (0B13h)	Latch monitor demand position (USR-LAT0: NEG-EDGE)	Indicates the demand position latched by the USR-LAT0 input (negative edge).	R	-	step	1417 (0589h)
2836 (0B14h)	2837 (0B15h)	Latch monitor actual position (USR-LAT0: NEG-EDGE)	Indicates the actual position latched by the USR-LAT0 input (negative edge).	R	-	step	1418 (058Ah)
2838 (0B16h)	2839 (0B17h)	Latch monitor target position (USR-LAT0: NEG-EDGE)	Indicates the target position latched by the USR-LAT0 input (negative edge).	R	-	step	1419 (058Bh)

Modbus communication register address		Name	Description	R/W	Initial setting		NET-ID
Upper	Lower				Initial value	Unit	
2840 (0B18h)	2841 (0B19h)	Latch monitor operation number (USR-LAT0: NEG-EDGE)	Indicates the operation number latched by the USR-LAT0 input (negative edge).	R	–	–	1420 (058Ch)
2842 (0B1Ah)	2843 (0B1Bh)	Latch monitor number of loop (USR-LAT0: NEG-EDGE)	Indicates the number of loop times latched by the USR-LAT0 input (negative edge).	R	–	–	1421 (058Dh)
2844 (0B1Ch)	2845 (0B1Dh)	Latch monitor number of latch (USR-LAT0: NEG-EDGE)	Indicates the number of times latched by the USR-LAT0 input (negative edge).	R	–	–	1422 (058Eh)
2846 (0B1Eh)	2847 (0B1Fh)	Latch monitor number of continuous uptime (USR-LAT0: NEG-EDGE)	Indicates the number of continuous uptime latched by the USR-LAT0 input (negative edge).	R	–	ms	1423 (058Fh)
2848 (0B20h)	2849 (0B21h)	Latch monitor status (USR-LAT1: POS-EDGE)	Indicates the status of the latch by the USR-LAT1 input (positive edge).	R	–	–	1424 (0590h)
2850 (0B22h)	2851 (0B23h)	Latch monitor demand position (USR-LAT1: POS-EDGE)	Indicates the demand position latched by the USR-LAT1 input (positive edge).	R	–	step	1425 (0591h)
2852 (0B24h)	2853 (0B25h)	Latch monitor actual position (USR-LAT1: POS-EDGE)	Indicates the actual position latched by the USR-LAT1 input (positive edge).	R	–	step	1426 (0592h)
2854 (0B26h)	2855 (0B27h)	Latch monitor target position (USR-LAT1: POS-EDGE)	Indicates the target position latched by the USR-LAT1 input (positive edge).	R	–	step	1427 (0593h)
2856 (0B28h)	2857 (0B29h)	Latch monitor operation number (USR-LAT1: POS-EDGE)	Indicates the operation number latched by the USR-LAT1 input (positive edge).	R	–	–	1428 (0594h)
2858 (0B2Ah)	2859 (0B2Bh)	Latch monitor number of loop (USR-LAT1: POS-EDGE)	Indicates the number of loop times latched by the USR-LAT1 input (positive edge).	R	–	–	1429 (0595h)
2860 (0B2Ch)	2861 (0B2Dh)	Latch monitor number of latch (USR-LAT1: POS-EDGE)	Indicates the number of times latched by the USR-LAT1 input (positive edge).	R	–	–	1430 (0596h)
2862 (0B2Eh)	2863 (0B2Fh)	Latch monitor number of continuous uptime (USR-LAT1: POS-EDGE)	Indicates the number of continuous uptime latched by the USR-LAT1 input (positive edge).	R	–	ms	1431 (0597h)
2864 (0B30h)	2865 (0B31h)	Latch monitor status (USR-LAT1: NEG-EDGE)	Indicates the status of the latch by the USR-LAT1 input (negative edge).	R	–	–	1432 (0598h)
2866 (0B32h)	2867 (0B33h)	Latch monitor demand position (USR-LAT1: NEG-EDGE)	Indicates the demand position latched by the USR-LAT1 input (negative edge).	R	–	step	1433 (0599h)
2868 (0B34h)	2869 (0B35h)	Latch monitor actual position (USR-LAT1: NEG-EDGE)	Indicates the actual position latched by the USR-LAT1 input (negative edge).	R	–	step	1434 (059Ah)
2870 (0B36h)	2871 (0B37h)	Latch monitor target position (USR-LAT1: NEG-EDGE)	Indicates the target position latched by the USR-LAT1 input (negative edge).	R	–	step	1435 (059Bh)
2872 (0B38h)	2873 (0B39h)	Latch monitor operation number (USR-LAT1: NEG-EDGE)	Indicates the operation number latched by the USR-LAT1 input (negative edge).	R	–	–	1436 (059Ch)
2874 (0B3Ah)	2875 (0B3Bh)	Latch monitor number of loop (USR-LAT1: NEG-EDGE)	Indicates the number of loop times latched by the USR-LAT1 input (negative edge).	R	–	–	1437 (059Dh)

Modbus communication register address		Name	Description	R/W	Initial setting		NET-ID
Upper	Lower				Initial value	Unit	
2876 (0B3Ch)	2877 (0B3Dh)	Latch monitor number of latch (USR-LAT1: NEG-EDGE)	Indicates the number of times latched by the USR-LAT1 input (negative edge).	R	–	–	1438 (059Eh)
2878 (0B3Eh)	2879 (0B3Fh)	Latch monitor number of continuous uptime (USR-LAT1: NEG-EDGE)	Indicates the number of continuous uptime latched by the USR-LAT1 input (negative edge).	R	–	ms	1439 (059Fh)
2880 (0B40h)	2881 (0B41h)	Latch monitor status (IO event – low event)	Indicates the status of the latch by the low event.	R	–	–	1440 (05A0h)
2882 (0B42h)	2883 (0B43h)	Latch monitor demand position (IO event – low event)	Indicates the demand position latched by the low event.	R	–	step	1441 (05A1h)
2884 (0B44h)	2885 (0B45h)	Latch monitor actual position (IO event – low event)	Indicates the actual position latched by the low event.	R	–	step	1442 (05A2h)
2886 (0B46h)	2887 (0B47h)	Latch monitor target position (IO event – low event)	Indicates the target position latched by the low event.	R	–	step	1443 (05A3h)
2888 (0B48h)	2889 (0B49h)	Latch monitor operation number (IO event – low event)	Indicates the operation number latched by the low event.	R	–	–	1444 (05A4h)
2890 (0B4Ah)	2891 (0B4Bh)	Latch monitor number of loop (IO event – low event)	Indicates the number of loop times latched by the low event.	R	–	–	1445 (05A5h)
2892 (0B4Ch)	2893 (0B4Dh)	Latch monitor number of latch (IO event – low event)	Indicates the number of times latched by the low event.	R	–	–	1446 (05A6h)
2894 (0B4Eh)	2895 (0B4Fh)	Latch monitor number of continuous uptime (IO event – low event)	Indicates the number of continuous uptime latched by the low event.	R	–	ms	1447 (05A7h)
2896 (0B50h)	2897 (0B51h)	Latch monitor status (IO event – middle event)	Indicates the status of the latch by the middle event.	R	–	–	1448 (05A8h)
2898 (0B52h)	2899 (0B53h)	Latch monitor demand position (IO event – middle event)	Indicates the demand position latched by the middle event.	R	–	step	1449 (05A9h)
2900 (0B54h)	2901 (0B55h)	Latch monitor actual position (IO event – middle event)	Indicates the actual position latched by the middle event.	R	–	step	1450 (05AAh)
2902 (0B56h)	2903 (0B57h)	Latch monitor target position (IO event – middle event)	Indicates the target position latched by the middle event.	R	–	step	1451 (05ABh)
2904 (0B58h)	2905 (0B59h)	Latch monitor operation number (IO event – middle event)	Indicates the operation number latched by the middle event.	R	–	–	1452 (05ACh)
2906 (0B5Ah)	2907 (0B5Bh)	Latch monitor number of loop (IO event – middle event)	Indicates the number of loop times latched by the middle event.	R	–	–	1453 (05ADh)

Modbus communication register address		Name	Description	R/W	Initial setting		NET-ID
Upper	Lower				Initial value	Unit	
2908 (0B5Ch)	2909 (0B5Dh)	Latch monitor number of latch (IO event – middle event)	Indicates the number of times latched by the middle event.	R	–	–	1454 (05AEh)
2910 (0B5Eh)	2911 (0B5Fh)	Latch monitor number of continuous uptime (IO event – middle event)	Indicates the number of continuous uptime latched by the middle event.	R	–	ms	1455 (05AFh)
2912 (0B60h)	2913 (0B61h)	Latch monitor status (IO event – high event)	Indicates the status of the latch by the high event.	R	–	–	1456 (05B0h)
2914 (0B62h)	2915 (0B63h)	Latch monitor demand position (IO event – high event)	Indicates the demand position latched by the high event.	R	–	step	1457 (05B1h)
2916 (0B64h)	2917 (0B65h)	Latch monitor actual position (IO event – high event)	Indicates the actual position latched by the high event.	R	–	step	1458 (05B2h)
2918 (0B66h)	2919 (0B67h)	Latch monitor target position (IO event – high event)	Indicates the target position latched by the high event.	R	–	step	1459 (05B3h)
2920 (0B68h)	2921 (0B69h)	Latch monitor operation number (IO event – high event)	Indicates the operation number latched by the high event.	R	–	–	1460 (05B4h)
2922 (0B6Ah)	2923 (0B6Bh)	Latch monitor number of loop (IO event – high event)	Indicates the number of loop times latched by the high event.	R	–	–	1461 (05B5h)
2924 (0B6Ch)	2925 (0B6Dh)	Latch monitor number of latch (IO event – high event)	Indicates the number of times latched by the high event.	R	–	–	1462 (05B6h)
2926 (0B6Eh)	2927 (0B6Fh)	Latch monitor number of continuous uptime (IO event – high event)	Indicates the number of continuous uptime latched by the high event.	R	–	ms	1463 (05B7h)
2928 (0B70h)	2929 (0B71h)	Latch monitor status (STOP)	Indicates the status of the latch by the stop input.	R	–	–	1464 (05B8h)
2930 (0B72h)	2931 (0B73h)	Latch monitor demand position (STOP)	Indicates the demand position latched by the stop input.	R	–	step	1465 (05B9h)
2932 (0B74h)	2933 (0B75h)	Latch monitor actual position (STOP)	Indicates the actual position latched by the stop input.	R	–	step	1466 (05BAh)
2934 (0B76h)	2935 (0B77h)	Latch monitor target position (STOP)	Indicates the target position latched by the stop input.	R	–	step	1467 (05BBh)
2936 (0B78h)	2937 (0B79h)	Latch monitor operation number (STOP)	Indicates the operation number latched by the stop input.	R	–	–	1468 (05BCh)
2938 (0B7Ah)	2939 (0B7Bh)	Latch monitor number of loop (STOP)	Indicates the number of loop times latched by the stop input.	R	–	–	1469 (05BDh)
2940 (0B7Ch)	2941 (0B7Dh)	Latch monitor number of latch (STOP)	Indicates the number of times latched by the stop input.	R	–	–	1470 (05BEh)
2942 (0B7Eh)	2943 (0B7Fh)	Latch monitor number of continuous uptime (STOP)	Indicates the number of continuous uptime latched by the stop input.	R	–	ms	1471 (05BFh)
2944 (0B80h)	2945 (0B81h)	Latch monitor status (NEXT)	Indicates the status of the latch by the NEXT input.	R	–	–	1472 (05C0h)
2946 (0B82h)	2947 (0B83h)	Latch monitor demand position (NEXT)	Indicates the demand position latched by the NEXT input.	R	–	step	1473 (05C1h)

Modbus communication register address		Name	Description	R/W	Initial setting		NET-ID
Upper	Lower				Initial value	Unit	
2948 (0B84h)	2949 (0B85h)	Latch monitor actual position (NEXT)	Indicates the actual position latched by the NEXT input.	R	–	step	1474 (05C2h)
2950 (0B86h)	2951 (0B87h)	Latch monitor target position (NEXT)	Indicates the target position latched by the NEXT input.	R	–	step	1475 (05C3h)
2952 (0B88h)	2953 (0B89h)	Latch monitor operation number (NEXT)	Indicates the operation number latched by the NEXT input.	R	–	–	1476 (05C4h)
2954 (0B8Ah)	2955 (0B8Bh)	Latch monitor number of loop (NEXT)	Indicates the number of loop times latched by the NEXT input.	R	–	–	1477 (05C5h)
2956 (0B8Ch)	2957 (0B8Dh)	Latch monitor number of latch (NEXT)	Indicates the number of times latched by the NEXT input.	R	–	–	1478 (05C6h)
2958 (0B8Eh)	2959 (0B8Fh)	Latch monitor number of continuous uptime (NEXT)	Indicates the number of continuous uptime latched by the NEXT input.	R	–	ms	1479 (05C7h)
3168 (0C60h)	3169 (0C61h)	FFT Value (1st peak) *1	Indicates the target FFT analysis result level (1st peak) set in the "FFT target" parameter.	R	–	–	1584 (0630h)
3170 (0C62h)	3171 (0C63h)	FFT Frequency (1st peak) *1	Indicates the target FFT analysis result frequency (1st peak) set in the "FFT target" parameter.	R	–	Hz	1585 (0631h)
3172 (0C64h)	3173 (0C65h)	FFT Value (2nd peak) *1	Indicates the target FFT analysis result level (2nd peak) set in the "FFT target" parameter.	R	–	–	1586 (0632h)
3174 (0C66h)	3175 (0C67h)	FFT Frequency (2nd peak) *1	Indicates the target FFT analysis result frequency (2nd peak) set in the "FFT target" parameter.	R	–	Hz	1587 (0633h)
3176 (0C68h)	3177 (0C69h)	FFT Value(3rd peak) *1	Indicates the target FFT analysis result level (3rd peak) set in the "FFT target" parameter.	R	–	–	1588 (0634h)
3178 (0C6Ah)	3179 (0C6Bh)	FFT Frequency (3rd peak) *1	Indicates the target FFT analysis result frequency (3rd peak) set in the "FFT target" parameter.	R	–	Hz	1589 (0635h)
3180 (0C6Ch)	3181 (0C6Dh)	FFT Value (4th peak) *1	Indicates the target FFT analysis result level (4th peak) set in the "FFT target" parameter.	R	–	–	1590 (0636h)
3182 (0C6Eh)	3183 (0C6Fh)	FFT Frequency (4th peak) *1	Indicates the target FFT analysis result frequency (4th peak) set in the "FFT target" parameter.	R	–	Hz	1591 (0637h)
3238 (0CA6h)	3239 (0CA7h)	Continuous operating time *2	Indicates the elapsed time from starting operation. 0 is shown during stop.	R	–	ms	1619 (0653h)
3240 (0CA8h)	3241 (0CA9h)	Continuous operating time buffer *2	Indicates the elapsed time from starting operation. The value is kept until operation is started.	R	–	ms	1620 (0654h)

*1 It supports the software version 2.02 or later of the driver.

*2 It is effective for the driver version 3.00 or later.

■ Information status 1

Modbus communication register address	Description							
246 (00F6h)	bit 15	bit 14	bit 13	bit 12	bit 11	bit 10	bit 9	bit 8
	INFO-REBOOT	INFO-CONFIG	INFO-IOTEST	INFO-DSLMTD	INFO-PRESET	-	-	-
	bit 7	bit 6	bit 5	bit 4	bit 3	bit 2	bit 1	bit 0
	-	-	-	-	-	-	INFO-VOLT-L	INFO-VOLT-H
247 (00F7h)	bit 15	bit 14	bit 13	bit 12	bit 11	bit 10	bit 9	bit 8
	-	-	-	INFO-WATT	INFO-TRQ	INFO-LOAD	INFO-MTRTMP	INFO-DRVTMP
	bit 7	bit 6	bit 5	bit 4	bit 3	bit 2	bit 1	bit 0
	INFO-SET-G	INFO-MNT-G	-	-	-	INFO-485-G	INFO-START-G	INFO-USRIO-G

Information history

Modbus communication register address	Description							
2656 (0A60h) + (Revision number – 1) × 8	bit 15	bit 14	bit 13	bit 12	bit 11	bit 10	bit 9	bit 8
	INFO-REBOOT	INFO-CONFIG	INFO-IOTEST	INFO-DSLMTD	INFO-PRESET	–	–	–
	bit 7	bit 6	bit 5	bit 4	bit 3	bit 2	bit 1	bit 0
	–	–	–	–	–	–	INFO-VOLT-L	INFO-VOLT-H
2657 (0A61h) + (Revision number – 1) × 8	bit 15	bit 14	bit 13	bit 12	bit 11	bit 10	bit 9	bit 8
	–	–	–	INFO-WATT	INFO-TRQ	INFO-LOAD	INFO-MTRTMP	INFO-DRVTMP
	bit 7	bit 6	bit 5	bit 4	bit 3	bit 2	bit 1	bit 0
	INFO-SET-G	INFO-MNT-G	–	–	–	INFO-485-G	INFO-START-G	INFO-USRIO-G
2658 (0A62h) + (Revision number – 1) × 8	bit 15	bit 14	bit 13	bit 12	bit 11	bit 10	bit 9	bit 8
	–	–	–	–	–	–	–	–
	bit 7	bit 6	bit 5	bit 4	bit 3	bit 2	bit 1	bit 0
	INFO-STLTIME	–	–	–	INFO-CULD1	INFO-CULD0	–	INFO-TLC-TIME
2659 (0A63h) + (Revision number – 1) × 8	bit 15	bit 14	bit 13	bit 12	bit 11	bit 10	bit 9	bit 8
	–	INFO-SPD-ERR	INFO-SPD-L	INFO-SPD-H	–	–	–	INFO-POS-ERR
	bit 7	bit 6	bit 5	bit 4	bit 3	bit 2	bit 1	bit 0
	INFO-USRIO7	INFO-USRIO6	INFO-USRIO5	INFO-USRIO4	INFO-USRIO3	INFO-USRIO2	INFO-USRIO1	INFO-USRIO0
2660 (0A64h) + (Revision number – 1) × 8	bit 15	bit 14	bit 13	bit 12	bit 11	bit 10	bit 9	bit 8
	–	–	–	–	–	–	–	INFO-CAN-WNG
	bit 7	bit 6	bit 5	bit 4	bit 3	bit 2	bit 1	bit 0
	–	–	–	–	–	INFO-485-INTVL	INFO-485-PRCST	INFO-485-ERR
2661 (0A65h) + (Revision number – 1) × 8	bit 15	bit 14	bit 13	bit 12	bit 11	bit 10	bit 9	bit 8
	–	INFO-PCOUNT	INFO-PTIME	INFO-CPU-LOAD	–	INFO-ODO	INFO-TRIP1	INFO-TRIP0
	bit 7	bit 6	bit 5	bit 4	bit 3	bit 2	bit 1	bit 0
	INFO-MP-RVCRNT	INFO-MP-FWCRNT	–	–	–	INFO-WH-TOTAL	INFO-WH-USR	INFO-WH-BOOT
2662 (0A66h) + (Revision number – 1) × 8	bit 15	bit 14	bit 13	bit 12	bit 11	bit 10	bit 9	bit 8
	–	–	–	–	–	INFO-ENC-FAULT	INFO-OC-FAULT	INFO-CPU-FAULT
	bit 7	bit 6	bit 5	bit 4	bit 3	bit 2	bit 1	bit 0
	–	–	–	–	–	–	INFO-SOFTLMT-E	INFO-UNIT-E
2663 (0A67h) + (Revision number – 1) × 8	bit 15	bit 14	bit 13	bit 12	bit 11	bit 10	bit 9	bit 8
	–	–	–	–	–	–	INFO-RV-OT	INFO-FW-OT
	bit 7	bit 6	bit 5	bit 4	bit 3	bit 2	bit 1	bit 0
	INFO-IODRV-DIS	–	INFO-START-DP	INFO-START-DD	INFO-START-SD	INFO-START-FWRV	INFO-START-HOME	–



A bit that "–" is indicated will be indefinite (0 or 1) if read.

■ Information status

Modbus communication register address	Description							
2784 (0AE0h)	bit 15	bit 14	bit 13	bit 12	bit 11	bit 10	bit 9	bit 8
	INFO-REBOOT	INFO-CONFIG	INFO-IOTEST	INFO-DSLMTD	INFO-PRESET	-	-	-
	bit 7	bit 6	bit 5	bit 4	bit 3	bit 2	bit 1	bit 0
	-	-	-	-	-	-	INFO-VOLT-L	INFO-VOLT-H
2785 (0AE1h)	bit 15	bit 14	bit 13	bit 12	bit 11	bit 10	bit 9	bit 8
	-	-	-	INFO-WATT	INFO-TRQ	INFO-LOAD	INFO-MTRTMP	INFO-DRVTMP
	bit 7	bit 6	bit 5	bit 4	bit 3	bit 2	bit 1	bit 0
	INFO-SET-G	INFO-MNT-G	-	-	-	INFO-485-G	INFO-START-G	INFO-USRIO-G
2786 (0AE2h)	bit 15	bit 14	bit 13	bit 12	bit 11	bit 10	bit 9	bit 8
	-	-	-	-	-	-	-	-
	bit 7	bit 6	bit 5	bit 4	bit 3	bit 2	bit 1	bit 0
	INFO-STLTIME	-	-	-	INFO-CULD1	INFO-CULD0	-	INFO-TLC-TIME
2787 (0AE3h)	bit 15	bit 14	bit 13	bit 12	bit 11	bit 10	bit 9	bit 8
	-	INFO-SPD-ERR	INFO-SPD-L	INFO-SPD-H	-	-	-	INFO-POS-ERR
	bit 7	bit 6	bit 5	bit 4	bit 3	bit 2	bit 1	bit 0
	INFO-USRIO7	INFO-USRIO6	INFO-USRIO5	INFO-USRIO4	INFO-USRIO3	INFO-USRIO2	INFO-USRIO1	INFO-USRIO0
2788 (0AE4h)	bit 15	bit 14	bit 13	bit 12	bit 11	bit 10	bit 9	bit 8
	-	-	-	-	-	-	-	INFO-CAN-WNG
	bit 7	bit 6	bit 5	bit 4	bit 3	bit 2	bit 1	bit 0
	-	-	-	-	-	INFO-485-INTVL	INFO-485-PRCST	INFO-485-ERR
2789 (0AE5h)	bit 15	bit 14	bit 13	bit 12	bit 11	bit 10	bit 9	bit 8
	-	INFO-PCOUNT	INFO-PTIME	INFO-CPU-LOAD	-	INFO-ODO	INFO-TRIP1	INFO-TRIP0
	bit 7	bit 6	bit 5	bit 4	bit 3	bit 2	bit 1	bit 0
	INFO-MP-RVCRNT	INFO-MP-FWCRNT	-	-	-	INFO-WH-TOTAL	INFO-WH-USR	INFO-WH-BOOT
2790 (0AE6h)	bit 15	bit 14	bit 13	bit 12	bit 11	bit 10	bit 9	bit 8
	-	-	-	-	-	INFO-ENC-FAULT	INFO-OC-FAULT	INFO-CPU-FAULT
	bit 7	bit 6	bit 5	bit 4	bit 3	bit 2	bit 1	bit 0
	-	-	-	-	-	-	INFO-SOFTLMT-E	INFO-UNIT-E
2791 (0AE7h)	bit 15	bit 14	bit 13	bit 12	bit 11	bit 10	bit 9	bit 8
	-	-	-	-	-	-	INFO-RV-OT	INFO-FW-OT
	bit 7	bit 6	bit 5	bit 4	bit 3	bit 2	bit 1	bit 0
	INFO-IODRV-DIS	-	INFO-START-DP	INFO-START-DD	INFO-START-SD	INFO-START-FWRV	INFO-START-HOME	-



A bit that "-" is indicated will be indefinite (0 or 1) if read.

■ Direct I/O

The arrangement of bits for direct I/O is indicated.

Modbus communication register address	Description							
212 (00D4h)	bit 15	bit 14	bit 13	bit 12	bit 11	bit 10	bit 9	bit 8
	–	–	–	–	–	–	–	–
	bit 7	bit 6	bit 5	bit 4	bit 3	bit 2	bit 1	bit 0
	–	–	–	–	–	–	DOUT1	DOUT0
213 (00D5h)	bit 15	bit 14	bit 13	bit 12	bit 11	bit 10	bit 9	bit 8
	–	–	–	–	–	–	–	–
	bit 7	bit 6	bit 5	bit 4	bit 3	bit 2	bit 1	bit 0
	–	–	–	–	DIN3	DIN2	DIN1	DIN0

■ I/O status

The arrangement of bits for internal I/O is indicated.

● Input signals

Modbus communication register address	Description							
	bit 15	bit 14	bit 13	bit 12	bit 11	bit 10	bit 9	bit 8
368 (0170h)	–	–	–	–	–	–	ATL-EN	PLOOP-MODE
	bit 7	bit 6	bit 5	bit 4	bit 3	bit 2	bit 1	bit 0
	–	–	–	–	SPD-LMT	TRQ-LMT	–	HMI
369 (0171h)	bit 15	bit 14	bit 13	bit 12	bit 11	bit 10	bit 9	bit 8
	–	INFO-CLR	LAT-CLR	ETO-CLR	–	EL-PRST	P-PRESET	ALM-RST
	bit 7	bit 6	bit 5	bit 4	bit 3	bit 2	bit 1	bit 0
	BREAK-ATSQ	–	STOP	QSTOP	CLR	S-ON	FREE	Not used
370 (0172h)	bit 15	bit 14	bit 13	bit 12	bit 11	bit 10	bit 9	bit 8
	–	–	RV-PSH	FW-PSH	RV-SPD	FW-SPD	RV-POS	FW-POS
	bit 7	bit 6	bit 5	bit 4	bit 3	bit 2	bit 1	bit 0
	–	–	RV-JOG-P	FW-JOG-P	RV-JOG-H	FW-JOG-H	RV-JOG	FW-JOG
371 (0173h)	bit 15	bit 14	bit 13	bit 12	bit 11	bit 10	bit 9	bit 8
	M7	M6	M5	M4	M3	M2	M1	M0
	bit 7	bit 6	bit 5	bit 4	bit 3	bit 2	bit 1	bit 0
	–	–	–	HOME	NEXT	–	SSTART	START
372 (0174h)	bit 15	bit 14	bit 13	bit 12	bit 11	bit 10	bit 9	bit 8
	D-SEL15	D-SEL14	D-SEL13	D-SEL12	D-SEL11	D-SEL10	D-SEL9	D-SEL8
	bit 7	bit 6	bit 5	bit 4	bit 3	bit 2	bit 1	bit 0
	D-SEL7	D-SEL6	D-SEL5	D-SEL4	D-SEL3	D-SEL2	D-SEL1	D-SEL0
373 (0175h)	bit 15	bit 14	bit 13	bit 12	bit 11	bit 10	bit 9	bit 8
	–	–	–	–	ID-SEL3	ID-SEL2	ID-SEL1	ID-SEL0
	bit 7	bit 6	bit 5	bit 4	bit 3	bit 2	bit 1	bit 0
	SLIT	HOMES	RV-LS	FW-LS	RV-BLK	FW-BLK	USR-LAT-IN1	USR-LAT-IN0
374 (0176h)	bit 15	bit 14	bit 13	bit 12	bit 11	bit 10	bit 9	bit 8
	R31	R30	R29	R28	R27	R26	R25	R24
	bit 7	bit 6	bit 5	bit 4	bit 3	bit 2	bit 1	bit 0
	R23	R22	R21	R20	R19	R18	R17	R16
375 (0177h)	bit 15	bit 14	bit 13	bit 12	bit 11	bit 10	bit 9	bit 8
	R15	R14	R13	R12	R11	R10	R9	R8
	bit 7	bit 6	bit 5	bit 4	bit 3	bit 2	bit 1	bit 0
	R7	R6	R5	R4	R3	R2	R1	R0

● Output signals

Modbus communication register address	Description							
	bit 15	bit 14	bit 13	bit 12	bit 11	bit 10	bit 9	bit 8
376 (0178h)	DDBUF-FULL	–	–	–	DELAY-BSY	SEQ-BSY	–	OPE-BSY
	bit 7	bit 6	bit 5	bit 4	bit 3	bit 2	bit 1	bit 0
	–	–	RDY-DPROF-OPE	RDY-DD-OPE	RDY-SD-OPE	RDY-FWRV-OPE	RDY-HOME-OPE	–
377 (0179h)	bit 15	bit 14	bit 13	bit 12	bit 11	bit 10	bit 9	bit 8
	–	ZV	VA	TLC	–	IN-POS	ETO-MON	SYS-BSY
	bit 7	bit 6	bit 5	bit 4	bit 3	bit 2	bit 1	bit 0
	INFO	MOVE	SON-MON	–	SYS-RDY	ALM-B	ALM-A	CONST-OFF
378 (017Ah)	bit 15	bit 14	bit 13	bit 12	bit 11	bit 10	bit 9	bit 8
	–	STOP-LAT	NEXT-LAT	JUMP2-LAT	JUMP1-LAT	JUMPO-LAT	USR-LAT1	USR-LAT0
	bit 7	bit 6	bit 5	bit 4	bit 3	bit 2	bit 1	bit 0
	–	–	–	–	–	ELPRST-MON	ABSPEN	HOME-END
379 (017Bh)	bit 15	bit 14	bit 13	bit 12	bit 11	bit 10	bit 9	bit 8
	MAREA	–	–	WRAP-ZERO	ZSG-N	RV-SLS	FW-SLS	WRAP-OVF
	bit 7	bit 6	bit 5	bit 4	bit 3	bit 2	bit 1	bit 0
	AREA7	AREA6	AREA5	AREA4	AREA3	AREA2	AREA1	AREA0
380 (017Ch)	bit 15	bit 14	bit 13	bit 12	bit 11	bit 10	bit 9	bit 8
	D-END15	D-END14	D-END13	D-END12	D-END11	D-END10	D-END9	D-END8
	bit 7	bit 6	bit 5	bit 4	bit 3	bit 2	bit 1	bit 0
	D-END7	D-END6	D-END5	D-END4	D-END3	D-END2	D-END1	D-END0
381 (017Dh)	bit 15	bit 14	bit 13	bit 12	bit 11	bit 10	bit 9	bit 8
	M-ACT7	M-ACT6	M-ACT5	M-ACT4	M-ACT3	M-ACT2	M-ACT1	M-ACT0
	bit 7	bit 6	bit 5	bit 4	bit 3	bit 2	bit 1	bit 0
	M-CHG	–	–	–	–	ATL-MON	SLIP	PLOOP-MON
382 (017Eh)	bit 15	bit 14	bit 13	bit 12	bit 11	bit 10	bit 9	bit 8
	–	–	HWTAIN-MON	EDM-MON	–	–	–	–
	bit 7	bit 6	bit 5	bit 4	bit 3	bit 2	bit 1	bit 0
	–	–	–	MBC	–	–	COMM-PWR	MAIN-PWR
383 (017Fh)	bit 15	bit 14	bit 13	bit 12	bit 11	bit 10	bit 9	bit 8
	USR-OUT7	USR-OUT6	USR-OUT5	USR-OUT4	USR-OUT3	USR-OUT2	USR-OUT1	USR-OUT0
	bit 7	bit 6	bit 5	bit 4	bit 3	bit 2	bit 1	bit 0
	–	–	–	OL-DTCT	–	–	SPD-LMTD	TRQ-LMTD



A bit that "–" is indicated will be indefinite (0 or 1) if read.

11 Operation data R/W commands

The operation data is set with the operation data R/W commands. To set the operation data, there are two methods, "direct reference" and "offset reference." Although addresses are different, the stored area is the same. Use them selectively in accordance with the intended use.

11-1 Direct reference

Direct reference is a method that the register address (base address) of the operation data number to be a reference point is specified to input. Use the direct reference via Modbus communication.

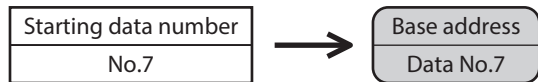

■ Base address of each operation data number

Modbus communication Base address		Operation data No.	Modbus communication Base address		Operation data No.	Modbus communication Base address		Operation data No.	Modbus communication Base address		Operation data No.
Dec	Hex		Dec	Hex		Dec	Hex		Dec	Hex	
6144	1800	No.0	8064	1F80	No.30	9984	2700	No.60	11904	2E80	No.90
6208	1840	No.1	8128	1FC0	No.31	10048	2740	No.61	11968	2EC0	No.91
6272	1880	No.2	8192	2000	No.32	10112	2780	No.62	12032	2F00	No.92
6336	18C0	No.3	8256	2040	No.33	10176	27C0	No.63	12096	2F40	No.93
6400	1900	No.4	8320	2080	No.34	10240	2800	No.64	12160	2F80	No.94
6464	1940	No.5	8384	20C0	No.35	10304	2840	No.65	12224	2FC0	No.95
6528	1980	No.6	8448	2100	No.36	10368	2880	No.66	12288	3000	No.96
6592	19C0	No.7	8512	2140	No.37	10432	28C0	No.67	12352	3040	No.97
6656	1A00	No.8	8576	2180	No.38	10496	2900	No.68	12416	3080	No.98
6720	1A40	No.9	8640	21C0	No.39	10560	2940	No.69	12480	30C0	No.99
6784	1A80	No.10	8704	2200	No.40	10624	2980	No.70	12544	3100	No.100
6848	1AC0	No.11	8768	2240	No.41	10688	29C0	No.71	12608	3140	No.101
6912	1B00	No.12	8832	2280	No.42	10752	2A00	No.72	12672	3180	No.102
6976	1B40	No.13	8896	22C0	No.43	10816	2A40	No.73	12736	31C0	No.103
7040	1B80	No.14	8960	2300	No.44	10880	2A80	No.74	12800	3200	No.104
7104	1BC0	No.15	9024	2340	No.45	10944	2AC0	No.75	12864	3240	No.105
7168	1C00	No.16	9088	2380	No.46	11008	2B00	No.76	12928	3280	No.106
7232	1C40	No.17	9152	23C0	No.47	11072	2B40	No.77	12992	32C0	No.107
7296	1C80	No.18	9216	2400	No.48	11136	2B80	No.78	13056	3300	No.108
7360	1CC0	No.19	9280	2440	No.49	11200	2BC0	No.79	13120	3340	No.109
7424	1D00	No.20	9344	2480	No.50	11264	2C00	No.80	13184	3380	No.110
7488	1D40	No.21	9408	24C0	No.51	11328	2C40	No.81	13248	33C0	No.111
7552	1D80	No.22	9472	2500	No.52	11392	2C80	No.82	13312	3400	No.112
7616	1DC0	No.23	9536	2540	No.53	11456	2CC0	No.83	13376	3440	No.113
7680	1E00	No.24	9600	2580	No.54	11520	2D00	No.84	13440	3480	No.114
7744	1E40	No.25	9664	25C0	No.55	11584	2D40	No.85	13504	34C0	No.115
7808	1E80	No.26	9728	2600	No.56	11648	2D80	No.86	13568	3500	No.116
7872	1EC0	No.27	9792	2640	No.57	11712	2DC0	No.87	13632	3540	No.117
7936	1F00	No.28	9856	2680	No.58	11776	2E00	No.88	13696	3580	No.118
8000	1F40	No.29	9920	26C0	No.59	11840	2E40	No.89	13760	35C0	No.119

Modbus communication Base address		Operation data No.	Modbus communication Base address		Operation data No.	Modbus communication Base address		Operation data No.	Modbus communication Base address		Operation data No.
Dec	Hex		Dec	Hex		Dec	Hex		Dec	Hex	
13824	3600	No.120	16000	3E80	No.154	18176	4700	No.188	20352	4F80	No.222
13888	3640	No.121	16064	3EC0	No.155	18240	4740	No.189	20416	4FC0	No.223
13952	3680	No.122	16128	3F00	No.156	18304	4780	No.190	20480	5000	No.224
14016	36C0	No.123	16192	3F40	No.157	18368	47C0	No.191	20544	5040	No.225
14080	3700	No.124	16256	3F80	No.158	18432	4800	No.192	20608	5080	No.226
14144	3740	No.125	16320	3FC0	No.159	18496	4840	No.193	20672	50C0	No.227
14208	3780	No.126	16384	4000	No.160	18560	4880	No.194	20736	5100	No.228
14272	37C0	No.127	16448	4040	No.161	18624	48C0	No.195	20800	5140	No.229
14336	3800	No.128	16512	4080	No.162	18688	4900	No.196	20864	5180	No.230
14400	3840	No.129	16576	40C0	No.163	18752	4940	No.197	20928	51C0	No.231
14464	3880	No.130	16640	4100	No.164	18816	4980	No.198	20992	5200	No.232
14528	38C0	No.131	16704	4140	No.165	18880	49C0	No.199	21056	5240	No.233
14592	3900	No.132	16768	4180	No.166	18944	4A00	No.200	21120	5280	No.234
14656	3940	No.133	16832	41C0	No.167	19008	4A40	No.201	21184	52C0	No.235
14720	3980	No.134	16896	4200	No.168	19072	4A80	No.202	21248	5300	No.236
14784	39C0	No.135	16960	4240	No.169	19136	4AC0	No.203	21312	5340	No.237
14848	3A00	No.136	17024	4280	No.170	19200	4B00	No.204	21376	5380	No.238
14912	3A40	No.137	17088	42C0	No.171	19264	4B40	No.205	21440	53C0	No.239
14976	3A80	No.138	17152	4300	No.172	19328	4B80	No.206	21504	5400	No.240
15040	3AC0	No.139	17216	4340	No.173	19392	4BC0	No.207	21568	5440	No.241
15104	3B00	No.140	17280	4380	No.174	19456	4C00	No.208	21632	5480	No.242
15168	3B40	No.141	17344	43C0	No.175	19520	4C40	No.209	21696	54C0	No.243
15232	3B80	No.142	17408	4400	No.176	19584	4C80	No.210	21760	5500	No.244
15296	3BC0	No.143	17472	4440	No.177	19648	4CC0	No.211	21824	5540	No.245
15360	3C00	No.144	17536	4480	No.178	19712	4D00	No.212	21888	5580	No.246
15424	3C40	No.145	17600	44C0	No.179	19776	4D40	No.213	21952	55C0	No.247
15488	3C80	No.146	17664	4500	No.180	19840	4D80	No.214	22016	5600	No.248
15552	3CC0	No.147	17728	4540	No.181	19904	4DC0	No.215	22080	5640	No.249
15616	3D00	No.148	17792	4580	No.182	19968	4E00	No.216	22144	5680	No.250
15680	3D40	No.149	17856	45C0	No.183	20032	4E40	No.217	22208	56C0	No.251
15744	3D80	No.150	17920	4600	No.184	20096	4E80	No.218	22272	5700	No.252
15808	3DC0	No.151	17984	4640	No.185	20160	4EC0	No.219	22336	5740	No.253
15872	3E00	No.152	18048	4680	No.186	20224	4F00	No.220	22400	5780	No.254
15936	3E40	No.153	18112	46C0	No.187	20288	4F40	No.221	22464	57C0	No.255



NET-ID of the base address is half the value of the Modbus communication base address.

■ Register address

The setting item of operation data is set with the operation data R/W command. The register address for the setting item is arranged based on the base address of the operation data number.

(Base address ⇨ p.338)

For example, in the case of the setting item "Position," adding 2 and 3 to the base address will be the upper address and the lower address, respectively.

Modbus communication register address	Name	Description	Initial setting		Update
			Initial value	Unit	
Base address +0 (upper)	Operation type	Selects the operation type. [Setting range] Refer to "3-4 Selecting the operation type" on p.63.	0	-	B
Base address +1 (lower)					
Base address +2 (upper)	Position	Sets the target position (travel amount). It is not used for continuous operation. [Setting range] -2,147,483,648 to 2,147,483,647 (User-defined position unit)	0	step	B
Base address +3 (lower)					
Base address +4 (upper)	Operating velocity	Sets the operating velocity. [Setting range] -4,000,000 to 4,000,000 (User-defined velocity unit)	0	r/min	B *2
Base address +5 (lower)					
Base address +6 (upper)	Acceleration rate	Sets the acceleration rate. [Setting range] 1 to 1,000,000,000 (User-defined velocity unit/s)	1,000	(r/min)/s	B
Base address +7 (lower)					
Base address +8 (upper)	Deceleration rate	Sets the deceleration rate. [Setting range] 1 to 1,000,000,000 (User-defined velocity unit/s)	1,000	(r/min)/s	B
Base address +9 (lower)					
Base address +10 (upper)	Torque limiting value	Sets the torque limiting value. [Setting range] 0 to 10,000 (1=0.1%) *1	10,000	1=0.1%	B *2
Base address +11 (lower)					
Base address +12 (upper)	Acceleration time	Sets the acceleration time. [Setting range] 1 to 1,000,000,000 ms	1,000	ms	B
Base address +13 (lower)					
Base address +14 (upper)	Deceleration time	Sets the deceleration time. [Setting range] 1 to 1,000,000,000 ms	1,000	ms	B
Base address +15 (lower)					
Base address +16 (upper)	Drive-complete delay time	Sets the waiting time generated after operation is completed. [Setting range] 0 to 65,535 ms	0	ms	B
Base address +17 (lower)					
Base address +18 (upper)	Link	Sets the mode for link operation. [Setting range] 0: No link 1: Manual sequential 2: Automatic sequential 3: Continuous sequential operation	0	-	B
Base address +19 (lower)					

Modbus communication register address	Name	Description	Initial setting		Update
			Initial value	Unit	
Base address +20 (upper)	Next data number	Sets the next data. [Setting range] -256: Stop -2: ↓↓(+2) -1: ↓(+1) 0 to 255: Operation data number	-1	-	B
Base address +21 (lower)					
Base address +22 (upper)	Area offset	Sets the distance from the center position of the range in which the MAREA output is turned ON to the target position of positioning operation. Sets the distance to the operation start position in the case of continuous operation. [Setting range] -2,147,483,648 to 2,147,483,647 (User-defined position unit)	0	step	B
Base address +23 (lower)					
Base address +24 (upper)	Area width	Sets the range in which the MAREA output is turned ON. [Setting range] -1: Disable 0 to 4,194,303 (User-defined position unit)	-1	step	B
Base address +25 (lower)					
Base address +26 (upper)	Loop count	Sets the number of times of loop. [Setting range] 0 to 100,000,000	0	-	B
Base address +27 (lower)					
Base address +28 (upper)	Loop offset	Offsets the position (travel amount) every time loop is executed. [Setting range] -4,194,304 to 4,194,303 (User-defined position unit)	0	step	B
Base address +29 (lower)					
Base address +30 (upper)	Loop end point	Sets to the operation data number in which loop is completed. [Setting range] 0: -(not the loop end point) 1: }L-End (loop end point)	0	-	B
Base address +31 (lower)					
Base address +32 (upper)	(Low) I/O event number	Sets the number of the operation I/O event to generate a low event. The condition to generate the event is set in the operation I/O event. [Setting range] -1: -(Disable) 0 to 31: Operation I/O event number	-1	-	B
Base address +33 (lower)					
Base address +34 (upper)	(Middle) I/O event number	Sets the number of the operation I/O event to generate a middle event. The condition to generate the event is set in the operation I/O event. [Setting range] -1: -(Disable) 0 to 31: Operation I/O event number	-1	-	B
Base address +35 (lower)					
Base address +36 (upper)	(High) I/O event number	Sets the number of the operation I/O event to generate a high event. The condition to generate the event is set in the operation I/O event. [Setting range] -1: -(Disable) 0 to 31: Operation I/O event number	-1	-	B
Base address +37 (lower)					

*1 The maximum torque limiting value varies depending on the motor. Refer to p.39 for the maximum value of each motor.

*2 "A: Update immediately" is applied in the case of continuous operation of FW/RV operation, (This is effective for drivers of version 3.00 or later.)

■ Setting example

As an example, this section explains how to set the following operation data to the operation data No.0 to No.2.

Setting item	Operation data No.0	Operation data No.1	Operation data No.2
Operation type	Absolute positioning	Incremental positioning (based on demand position)	Incremental positioning (based on actual position)
Position [step]	1,000	1,000	1,000
Operating velocity [r/min]	1,000	1,000	1,000

● Setting of operation data No.0

From the table on p.338, we can find that the base address of the operation data No.0 is "6144 (1800h)."
Based on this base address, the register address for the setting item is calculated from the table on p.340.

Base address 6144 (1800h)	Setting item	Modbus communication register address			Setting value
		Calculation method	Dec	Hex	
	Operation type	Upper: Base address +0	6144 + 0 = 6144	1800h	1
		Lower: Base address +1	6144 + 1 = 6145	1801h	
	Position	Upper: Base address +2	6144 + 2 = 6146	1802h	1,000
		Lower: Base address +3	6144 + 3 = 6147	1803h	
	Operating velocity	Upper: Base address +4	6144 + 4 = 6148	1804h	1,000
		Lower: Base address +5	6144 + 5 = 6149	1805h	

● Setting of operation data No.1

From the table on p.338, we can find that the base address of the operation data No.1 is "6208 (1840h)."
Based on this base address, the register address for the setting item is calculated from the table on p.340.

Base address 6208 (1840h)	Setting item	Modbus communication register address			Setting value
		Calculation method	Dec	Hex	
	Operation type	Upper: Base address +0	6208 + 0 = 6208	1840h	2
		Lower: Base address +1	6208 + 1 = 6209	1841h	
	Position	Upper: Base address +2	6208 + 2 = 6210	1842h	1,000
		Lower: Base address +3	6208 + 3 = 6211	1843h	
	Operating velocity	Upper: Base address +4	6208 + 4 = 6212	1844h	1,000
		Lower: Base address +5	6208 + 5 = 6213	1845h	

● Setting of operation data No.2

From the table on p.338, we can find that the base address of the operation data No.2 is "6272 (1880h)."
Based on this base address, the register address for the setting item is calculated from the table on p.340.

Base address 6272 (1880h)	Setting item	Modbus communication register address			Setting value
		Calculation method	Dec	Hex	
	Operation type	Upper: Base address +0	6272 + 0 = 6272	1880h	3
		Lower: Base address +1	6272 + 1 = 6273	1881h	
	Position	Upper: Base address +2	6272 + 2 = 6274	1882h	1,000
		Lower: Base address +3	6272 + 3 = 6275	1883h	
	Operating velocity	Upper: Base address +4	6272 + 4 = 6276	1884h	1,000
		Lower: Base address +5	6272 + 5 = 6277	1885h	

11-2 Offset reference

Offset reference is a method that an operating data number to be the starting point (starting data number) is set and an offset from the starting data number is specified to input. Set the the starting data number with the "DATA offset reference origin" parameter.

(Base address ⇒ p.338)

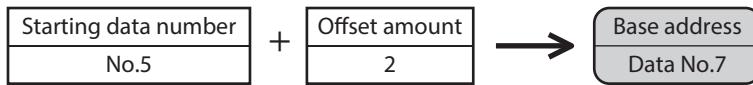

The offset reference can be used for Modbus communication conveniently because the address of the setting item is not necessary to change if only the data number of the starting point is changed. Use it to edit a large volume of operation data, on the touch screen, for example.

Related parameter

Modbus communication register address		Parameter name	Description	R/W	Initial setting		NET-ID
Upper	Lower				Initial value	Unit	
6142 (17FEh)	6143 (17FFh)	DATA offset reference origin	Sets the operation data number that is the starting point of offset reference. [Setting range] 0 to 255: Operation data number	R/W	0	–	3071 (0BFFh)



The setting value of the "DATA offset reference origin" parameter is stored in RAM.

12 Operation I/O event R/W commands

If a specified event (ON/OFF of I/O) is generated during operation of the motor, another operation can be started. This is called operation I/O event. This chapter explains the address to execute the operation I/O event.

12-1 Setting method

As with the setting of operation data, there are "direct reference" and "offset reference" in the operation I/O event. Direct reference is a method that an address of the event number to be a reference point (base address) is specified to access.

(Reference ⇨ Next section)

Offset reference is a method that an event number to be the starting point (starting event number) is set and an offset from the starting event number is specified to access. Set the starting event number with the "Event offset reference origin" parameter.

(Reference ⇨ p.346)



The setting value of the "Event offset reference origin" parameter is stored in RAM.

12-2 Direct reference

Direct reference is a method that an address of the operation I/O event number to be a reference point (base address) is specified to access.

■ Base address of operation I/O event

Modbus communication base address	Operation I/O event number	Modbus communication base address	Operation I/O event number
5120 (1400h)	0	5376 (1500h)	16
5136 (1410h)	1	5392 (1510h)	17
5152 (1420h)	2	5408 (1520h)	18
5168 (1430h)	3	5424 (1530h)	19
5184 (1440h)	4	5440 (1540h)	20
5200 (1450h)	5	5456 (1550h)	21
5216 (1460h)	6	5472 (1560h)	22
5232 (1470h)	7	5488 (1570h)	23
5248 (1480h)	8	5504 (1580h)	24
5264 (1490h)	9	5520 (1590h)	25
5280 (14A0h)	10	5536 (15A0h)	26
5296 (14B0h)	11	5552 (15B0h)	27
5312 (14C0h)	12	5568 (15C0h)	28
5328 (14D0h)	13	5584 (15D0h)	29
5344 (14E0h)	14	5600 (15E0h)	30
5360 (14F0h)	15	5616 (15F0h)	31



NET-ID of the base address is half the value of the Modbus communication base address.

■ Addresses of operation I/O event R/W commands

The setting items of operation I/O event are set with the operation I/O event R/W commands.

The addresses of the setting items are arranged based on the base address of the operation I/O event (base command code).

(Base address of operation I/O event ⇨ p.344)

For example, in the case of Modbus communication, if 4 and 5 are added to the base address, the setting item of "Dwell" will be the upper address and the lower address, respectively.

Modbus communication register address	Name	Description	Initial setting		Update
			Initial value	Unit	
Base address +0 (upper)	Event link	Sets the linked method after event trigger detection. [Setting range] 0: No link 1: Manual sequential 2: Automatic sequential 3: Continuous sequential operation	0	-	B
Base address +1 (lower)					
Base address +2 (upper)	Event jump destination	Sets the next data. [Setting range] -256: Stop -2: ↓↓(+2) -1: ↓(+1) 0 to 255: Operation data number	-256	-	B
Base address +3 (lower)					
Base address +4 (upper)	Event waiting time	Sets the waiting time generated after event trigger detection. [Setting range] 0 to 1,000,000 ms	0	ms	B
Base address +5 (lower)					
Base address +6 (upper)	Event trigger I/O	Sets I/O to be used as an event trigger. [Setting range] "2 Signals list" on p.151	0: Not used	-	B
Base address +7 (lower)					
Base address +8 (upper)	Event trigger type	Sets the timing to detect the event trigger. [Setting range] 0: Not event execution 1: ON (calculated cumulative: ms) 2: ON (continuous: ms) 3: OFF (calculated cumulative: ms) 4: OFF (continuous: ms) 5: ON (form: positive edge↑) 6: OFF(form: negative edge↓) 7 ON (cumulative: ms) 8: OFF (cumulative: ms)	0	-	B
Base address +9 (lower)					
Base address +10 (upper)	Event trigger counter	Sets the judgment time to detect the event trigger or the number of times of detection. [Setting range] 0 to 1,000,000 (1 = 1 ms or 1 = once)	0	-	B
Base address +11 (lower)					

12-3 Offset reference

Offset reference is a method that an event number to be the starting point (starting event number) is set and an offset from the starting event number is specified to access. Set the starting event number with the "Event offset reference origin" parameter.

Related parameter

Modbus communication register address		Parameter name	Description	R/W	Initial setting		NET-ID
Upper	Lower				Initial value	Unit	
5118 (13FEh)	5119 (13FFh)	Event offset reference origin	Sets the I/O event number that is the starting point of offset reference. [Setting range] 0 to 31: I/O event number	R/W	0	-	2559 (09FFh)

 The setting value of the "Event offset reference origin" parameter is stored in RAM.

■ Address of setting item

Modbus communication register address		Setting item
Upper	Lower	
5120 (1400h)	5121 (1401h)	Event link
5122 (1402h)	5123 (1403h)	Event jump destination
5124 (1404h)	5125 (1405h)	Event waiting time
5126 (1406h)	5127 (1407h)	Event trigger I/O
5128 (1408h)	5129 (1409h)	Event trigger type
5130 (140Ah)	5131 (140Bh)	Event trigger counter

■ Setting example

As an example, the setting address when the event No.0, No.1, and No.10 are set as the starting event is explained. The offset reference is not required to change the address of the setting item if only the event number of the starting point is changed.

This is a convenient access method to edit a large volume of operation data, on the touch screen, for example.

● Starting event No.0 (initial value)

Modbus communication base address	Operation I/O event number
5120 (1400h)	Starting event No. + 0 = 0
5136 (1410h)	Starting event No. + 1 = 1
...	...
5376 (1500h)	Starting event No. + 16 = 16
5392 (1510h)	Starting event No. + 17 = 17

● Starting event No.1

Modbus communication base address	Operation I/O event number
5120 (1400h)	Starting event No. + 0 = 1
5136 (1410h)	Starting event No. + 1 = 2
...	...
5376 (1500h)	Starting event No. + 16 = 17
5392 (1510h)	Starting event No. + 17 = 18

● Starting event No.10

Modbus communication base address	Operation I/O event number
5120 (1400h)	Starting event No.0 = 10
5136 (1410h)	Starting event No. + 1 = 11
...	...
5376 (1500h)	Starting event No. + 16 = 26
5392 (1510h)	Starting event No. + 17 = 27

13 Parameter R/W commands

These commands are used to write or read parameters. All commands can be read and written (READ/WRITE).

13-1 Basic setting and operation setting

Modbus communication register address		Name	Description	Update	Initial setting		NET-ID
Upper	Lower				Initial value	Unit	
544 (0220h)	545 (0221h)	Direct data operation zero velocity command action	When "0" is written to the operating velocity, selects whether to decelerate the motor to a stop or to change only the velocity to "0" in an operating status. [Setting range] 0: Deceleration stop command 1: Velocity zero command *1	A	0	–	272 (0110h)
546 (0222h)	547 (0223h)	Direct data operation trigger initial value	Sets the initial value of the trigger (lower 16 bits). [Setting range] –7: Operation data number update –6: Operation type update –5: Position update –4: Operating velocity update –3: Acceleration rate update –2: Deceleration rate update –1: Torque limiting value update 0: The trigger is used	A	0	–	273 (0111h)
548 (0224h)	549 (0225h)	Direct data operation data destination initial value	Sets the initial value of the data destination. [Setting range] 0: Execution memory 1: Buffer memory	A	0	–	274 (0112h)
550 (0226h)	551 (0227h)	Direct data operation operation parameter initial value reference data number	Sets the operation data number to be used as the initial value for direct data operation. [Setting range] 0 to 255: Operation data number	A	0	–	275 (0113h)

Modbus communication register address		Name	Description	Update	Initial setting		NET-ID
Upper	Lower				Initial value	Unit	
552 (0228h)	553 (0229h)	Direct data operation trigger automatic clear	Sets the movement when setting "Direct data operation trigger" which is set the trigger factor to transfer or update the data in the direct data operation memory area as execution data. When this parameter is set to enable, if direct data operation is started by writing to "Direct data operation trigger," the trigger (lower 16 bits) of "Direct data operation trigger" is automatically cleared to "0" regardless of whether it is successful or not. Therefore, if the same data is written, direct data operation can be started as many times as written. When this parameter is set to disable, "Direct data operation trigger" is not cleared to 0 even if it is written. Therefore, direct data operation is not started even if the same data is written in succession. To restart, one of the following is required. <ul style="list-style-type: none"> • Write "0" to "Direct data operation trigger" and then write the value for starting. • Write a different value to "Direct data operation trigger." [Setting range] 0: Disable 1: Enable	A	1	–	276 (0114h)
572 (023Ch)	573 (023Dh)	Direct data operation lifetime initial value *2	Sets the initial value for direct data operation lifetime. [Setting range] 0: Disable 1 to 32,767 ms	A	0	ms	286 (011Eh)
644 (0284h)	645 (0285h)	Starting velocity	Sets the starting velocity for operation. *3 [Setting range] 0 to 4,000,000 (User-defined velocity unit)	A	0	r/min	322 (0142h)
656 (0290h)	657 (0291h)	Permission of absolute positioning without setting absolute coordinates	Permits absolute positioning operation in a state where coordinates are not set. [Setting range] 0: Disable 1: Enable	A	0	–	328 (0148h)
658 (0292h)	659 (0293h)	Acceleration/ deceleration setting method *4	Selects the setting method for the acceleration rate and the deceleration rate. [Setting range] 0: Acceleration/deceleration 1: Changing velocity/stop (AZ compatible)	A	0	–	329 (0149h)
660 (0294h)	661 (0295h)	Torque limit setting at motor standstill	Selects the operating torque limit when the motor stops. [Setting range] 0: Follow the selection number 1: Maintain the previous operating torque limit (reset by excitation OFF)	A	1	–	330 (014Ah)
662 (0296h)	663 (0297h)	ATL function mode setting	Selects the setting method of the ATL function. [Setting Range] 0: Follow ATL-EN input 1: ATL function enabled	A	1	–	331 (014Bh)

Modbus communication register address		Name	Description	Update	Initial setting		NET-ID
Upper	Lower				Initial value	Unit	
902 (0386h)	903 (0387h)	Software overtravel action	Sets the operation when the demand position reaches the software limit. [Setting range] -1: Disable 0: Immediate stop 1: Deceleration stop (according to the operation profile during operation) 2: Follow QSTOP setting (current is not cut off) 3: Follow STOP setting 4: Immediate stop with alarm 5: Deceleration stop with alarm (according to the operation profile during operation) 6: Follow QSTOP setting with alarm (current is not cut off) 7: Follow STOP setting with alarm	A	6	–	451 (01C3h)
904 (0388h)	905 (0389h)	Max software limit	Sets the maximum value of the software limit. [Setting range] –2,147,483,648 to 2,147,483,647 (User-defined position unit)	A	0	step	452 (01C4h)
906 (038Ah)	907 (038Bh)	Min software limit	Sets the minimum value of the software limit. [Setting range] –2,147,483,648 to 2,147,483,647 (User-defined position unit)	A	0	step	453 (01C5h)
908 (038Ch)	909 (038Dh)	Home offset	Sets the amount of offset from the home when homing operation is completed or P-PRESET is executed. [Setting range] –2,147,483,648 to 2,147,483,647 (User-defined position unit)	A	0	step	454 (01C6h)
910 (038Eh)	911 (038Fh)	Valid position range	Sets the criterion of the software limit. [Setting range] 0: [Software limit] - [Home offset] (CiA402 compatible) 1: Software limit (AZ compatible)	A	0	–	455 (01C7h)
1022 (03FEh)	1023 (03FFh)	Driver operation mode	Operation can be simulated using a virtual motor without connecting a motor. [Setting range] 0: Use real motor 1: Virtual motor	D	0	–	511 (01FFh)
5072 (13D0h)	5073 (13D1h)	Timeout of waiting for motor rotation stop at standstill *2	Sets the timeout period from when the velocity demand becomes zero at standstill until the motor actually stops rotating. When the timeout occurs, the MOVE output is turned OFF. [Setting range] –1: No timeout setting 0 to 32,767 ms	A	1,000	ms	2536 (09E8h)

*1 Although the motor does not rotate because the velocity is "0," the output signals are in an operating status.

*2 It is effective for the driver version 3.00 or later.

*3 When combined with a gear, set the "Starting velocity" parameter so that the motor shaft speed is 300 r/min or lower.

*4 When the operation type is "Continuous operation (cyclic speed control)," the "Acceleration/deceleration setting method" parameter is not applied.

13-2 Unit setting, coordinate setting, mechanism setting, jog setting, homing setting

Modbus communication register address		Name	Description	Update	Initial setting		NET-ID
Upper	Lower				Initial value	Unit	
672 (02A0h)	673 (02A1h)	(JOG) Travel amount	Sets the travel amount for inching operation. [Setting range] 1 to 8,388,607 (User-defined position unit)	A	1	step	336 (0150h)
674 (02A2h)	675 (02A3h)	(JOG) Operating velocity	Sets the operating velocity for JOG operation and inching operation. [Setting range] 1 to 4,000,000 (User-defined velocity unit)	A	100	r/min	337 (0151h)
676 (02A4h)	677 (02A5h)	(JOG) Acceleration/ deceleration	Sets the acceleration/deceleration rate or the acceleration/deceleration time. [Setting range] 1 to 1,000,000,000 (User-defined acceleration unit)	A	1,000	ms	338 (0152h)
678 (02A6h)	679 (02A7h)	(JOG) Starting velocity	Sets the starting velocity. *1 [Setting range] 0 to 4,000,000 (User-defined velocity unit)	A	0	r/min	339 (0153h)
680 (02A8h)	681 (02A9h)	(JOG) Operating velocity (high)	Sets the operating velocity for high-speed JOG operation. [Setting range] 1 to 4,000,000 (User-defined velocity unit)	A	500	r/min	340 (0154h)
700 (02BCh)	701 (02BDh)	JOG/HOME command filter time constant	Sets the time constant for the command filter. [Setting range] 1 to 200 ms	A	1	ms	350 (015Eh)
702 (02BEh)	703 (02BFh)	JOG/HOME Torque limit value	Sets the torque limiting value. [Setting range] 0 to 10,000 (1=0.1%) *2	A	10,000	1=0.1%	351 (015Fh)
704 (02C0h)	705 (02C1h)	(HOME) Homing mode	Sets the homing method. [Setting range] 0: 2 sensors 1: 3 sensors 2: One-way rotation 3: Push	A	1	–	352 (0160h)
706 (02C2h)	707 (02C3h)	(HOME) Starting direction	Sets the starting direction for home detection. [Setting range] 0: Negative side 1: Positive side	A	1	–	353 (0161h)
708 (02C4h)	709 (02C5h)	(HOME) Acceleration/ deceleration	Sets the acceleration/deceleration rate or the acceleration/deceleration time. [Setting range] 1 to 1,000,000,000 (User-defined acceleration unit)	A	1,000	ms	354 (0162h)
710 (02C6h)	711 (02C7h)	(HOME) Starting velocity	Sets the starting velocity. *1 [Setting range] 1 to 4,000,000 (User-defined velocity unit)	A	30	r/min	355 (0163h)

Modbus communication register address		Name	Description	Update	Initial setting		NET-ID
Upper	Lower				Initial value	Unit	
712 (02C8h)	713 (02C9h)	(HOME) Operating velocity	Sets the operating velocity. [Setting range] 1 to 4,000,000 (User-defined velocity unit)	A	60	r/min	356 (0164h)
714 (02CAh)	715 (02CBh)	(HOME) Last velocity	Sets the operating velocity when finally positioning with the home. *1 [Setting range] 1 to 4,000,000 (User-defined velocity unit)	A	30	r/min	357 (0165h)
716 (02CCh)	717 (02CDh)	(HOME) SLIT detection	Sets whether to use the SLIT input together when returning to the home. [Setting range] 0: Disable 1: Enable	A	0	–	358 (0166h)
718 (02CEh)	719 (02CFh)	(HOME) ZSG signal detection	Sets whether to use the ZSG-N signal together when returning to the home. [Setting range] 0: Disable 2: ZSG	A	0	–	359 (0167h)
720 (02D0h)	721 (02D1h)	(HOME) Travel amount of additional operation after homing	Sets the travel amount for homing additional operation. [Setting range] –2,147,483,647 to 2,147,483,647 (User-defined position unit)	A	0	step	360 (0168h)
722 (02D2h)	723 (02D3h)	(HOME) Backward steps in 2 sensor homing	Sets the amount of backward steps after homing operation in 2-sensor mode. [Setting range] 0 to 8,388,607 (User-defined position unit)	A	18,000	step	361 (0169h)
724 (02D4h)	725 (02D5h)	(HOME) Operating amount in unidirectional homing	Sets the operating amount after homing operation in one-way rotation mode. [Setting range] 0 to 8,388,607 (User-defined position unit)	A	18,000	step	362 (016Ah)
726 (02D6h)	727 (02D7h)	(HOME) Torque limit value for push-homing	Sets the torque limiting value for push-motion homing. [Setting range] 0 to 1,000 (1=0.1%) *2	A	1,000	1=0.1%	363 (016Bh)
728 (02D8h)	729 (02D9h)	(HOME) Backward steps after first entry in push-homing	Sets the amount of backward steps after first detecting the mechanical end in push-motion homing operation. [Setting range] 0 to 8,388,607 (User-defined position unit)	A	0	step	364 (016Ch)
730 (02DAh)	731 (02DBh)	(HOME) Pushing time in push-homing	Sets the generation time of the TLC output that judges the completion of push motion. [Setting range] 1 to 65,535 ms	A	200	ms	365 (016Dh)
732 (02DCh)	733 (02DDh)	(HOME) Backward steps in push-homing	Sets the amount of backward steps after fixing the mechanical end position in push-motion homing operation. [Setting range] 0 to 8,388,607 (User-defined position unit)	A	18,000	step	366 (016Eh)

Modbus communication register address		Name	Description	Update	Initial setting		NET-ID
Upper	Lower				Initial value	Unit	
832 (0340h)	833 (0341h)	User-defined position unit setting	Sets the position unit. [Setting range] 0: Encoder setting is prioritized (Use [Control resolution] if not a mechanical product) 1: Control resolution (step) 10: Use mechanism unit (×1) 11: Use mechanism unit (×0.1) 12: Use mechanism unit (×0.01) 13: Use mechanism unit (×0.001) 23: 0.001 rev (driving shaft of gearbox) 24: 0.0001 rev (driving shaft of gearbox) 25: 0.00001 rev (driving shaft of gearbox) 26: 0.000001 rev (driving shaft of gearbox) 31: 0.1 deg (driving shaft of gearbox) 32: 0.01 deg (driving shaft of gearbox) 33: 0.001 deg (driving shaft of gearbox) 34: 0.0001 deg (driving shaft of gearbox)	C	0	–	416 (01A0h)
834 (0342h)	835 (0343h)	User-defined velocity unit setting	Sets the velocity unit. [Setting range] 0: Position unit is "Control resolution": r/min (motor shaft), others: position unit/s 1: Position unit/s 2: r/min (motor shaft) 11: 0.1 r/min (motor shaft) 12: 0.01 r/min (motor shaft) 20: 1 r/min (driving shaft of gearbox) 21: 0.1 r/min (driving shaft of gearbox) 22: 0.01 r/min (driving shaft of gearbox) 23: 0.001 r/min (driving shaft of gearbox) 24: 0.0001 r/min (driving shaft of gearbox) 25: 0.00001 r/min (driving shaft of gearbox)	C	0	–	417 (01A1h)
836 (0344h)	837 (0345h)	User-defined acceleration/deceleration unit setting (DD, FWRV, SD, HOME operation)	Sets the acceleration/deceleration unit. *3 [Setting range] 0: (User-defined velocity unit)/s 1: ms	A	1	–	418 (01A2h)
840 (0348h)	841 (0349h)	Motor rotation direction	Sets the rotation direction of the motor shaft. [Setting range] 0: Not invert 1: Invert	C	0	–	420 (01A4h)
842 (034Ah)	843 (034Bh)	Position/velocity coordinate direction	Sets directions for the position coordinate and the velocity coordinate. [Setting range] 0: Follow unit setting 1: Match the direction of velocity coordinate with position coordinate 2: Match the direction of position coordinate with velocity coordinate	C	2	–	421 (01A5h)
844 (034Ch)	845 (034Dh)	Torque coordinate direction	Selects the coordinate to be used as a reference with the torque monitor. [Setting range] 0: Based on position coordinate 1: Based on velocity coordinate	C	1	–	422 (01A6h)

Modbus communication register address		Name	Description	Update	Initial setting		NET-ID
Upper	Lower				Initial value	Unit	
848 (0350h)	849 (0351h)	Control resolution (numerator)	Sets the numerator of the control resolution. [Setting range] 500 to 67,108,863	C	36,000	–	424 (01A8h)
850 (0352h)	851 (0353h)	Control resolution (denominator)	Sets the denominator of the control resolution. [Setting range] 1 to 65,535	C	1	–	425 (01A9h)
856 (0358h)	857 (0359h)	Gear information (numerator)	Sets the numerator of the gear ratio. [Setting range] 1 to 1,000	C	1	–	428 (01ACh)
858 (035Ah)	859 (035Bh)	Gear information (denominator)	Sets the denominator of the gear ratio. [Setting range] 1 to 1,000	C	1	–	429 (01ADh)
860 (035Ch)	861 (035Dh)	Gear rotation direction	Sets the rotation direction of the driving shaft of the gearbox. [Setting range] 0: Not invert 1: Invert	C	0	–	430 (01AEh)
864 (0360h)	865 (0361h)	Mechanism information specifications	Sets the mechanism information specifications. [Setting range] 0: Encoder setting is prioritized (if not a mechanical product, no unit) 1: Encoder setting is prioritized (if not a mechanical product, linear motion [mm], setting: travel amount [mm/rev]) 2: Encoder setting is prioritized (if not a mechanical product, wheel [mm], setting: diameter [mm]) 5: Encoder setting is prioritized (if not a mechanical product, rotation [rev], setting: mechanism reduction ratio) 6: Encoder setting is prioritized (if not a mechanical product, rotation [deg], setting: mechanism reduction ratio) 8: No unit 9: Linear motion [mm], setting: travel amount [mm/rev] 10: Wheel [mm], setting: diameter [mm] 13: Rotation [rev], setting: mechanism reduction ratio 14: Rotation [deg], setting: mechanism reduction ratio	C	2	–	432 (01B0h)
866 (0362h)	867 (0363h)	Mechanism information (numerator)	Sets the numerator of mechanism information. [Setting range] 1 to 65,535	C	1	–	433 (01B1h)
868 (0364h)	866 (0365h)	Mechanism information (denominator)	Sets the denominator of mechanism information. [Setting range] 1 to 65,535	C	1	–	434 (01B2h)

Modbus communication register address		Name	Description	Update	Initial setting		NET-ID
Upper	Lower				Initial value	Unit	
870 (0366h)	871 (0367h)	Mechanism traveling direction	Sets the travel direction of the mechanism. [Setting range] 0: Not invert 1: Invert	C	0	–	435 (01B3h)
916 (0394h)	917 (0395h)	WRAP setting	Sets the WRAP setting. [Setting range] 1: 32-bit range (WRAP-type operation disabled/WRAP-ZERO output disabled) 2: Follows WRAP setting lower limit/WRAP setting upper limit	C	1	–	458 (01CAh)
918 (0396h)	919 (0397h)	WRAP setting lower limit	Sets the lower limit value of the WRAP setting. [Setting range] –536,870,912 to 0 (User-defined position unit)	C	0	step	459 (01CBh)
920 (0398h)	921 (0399h)	WRAP setting upper limit	Sets the upper limit value of the WRAP setting. [Setting range] 0 to 536,870,911 (User-defined position unit)	C	0	step	460 (01CCh)
922 (039Ah)	923 (039Bh)	The number of the WRAP-ZERO output in wrap range	Sets how often the WRAP-ZERO output is turned ON within the WRAP range. [Setting range] 1 to 536,870,911 divisions	C	1	–	461 (01CDh)

*1 When combined with a gear, set the "JOG starting speed" parameter and the "(HOME) Starting velocity" parameter and the "(HOME) Last velocity" parameters so that the motor shaft speed is 300 r/min or lower.

*2 The maximum torque limiting value varies depending on the motor. Refer to p.39 for the maximum value of each motor.

*3 The "User-defined acceleration/deceleration unit setting (DD,FWRV, SD, HOME operation)" parameter is not applied when the product is operated with the drive profile (CAN communication).

13-3 Communication setting (Modbus/CANopen)

Modbus communication register address		Name	Description	Update	Initial setting		NET-ID
Upper	Lower				Initial value	Unit	
958 (03BEh)	959 (03BFh)	Communication power supply lost action	<p>Selects the movement when the communication power supply is lost.</p> <p>[Setting range] -1: Disable 0: Immediate stop 1: Deceleration rate stop (according to the operation profile during operation) 2: Follow QSTOP setting (current is not cut off) 3: Follow STOP setting 4: Immediate stop with alarm 5: Deceleration stop with alarm (according to the operation profile during operation) 6: Follow QSTOP setting with alarm (current is not cut off) 7: Follow STOP setting with alarm</p>	A	-1	-	479 (01DFh)

Modbus communication register address		Name	Description	Update	Initial setting		NET-ID
Upper	Lower				Initial value	Unit	
990 (03DEh)	991 (03DFh)	RS-485 communication termination resistor	<p>Selects the setting of the termination resistor for RS-485 communication built in the driver.</p> <p>[Setting Range] –1: Enable 0: Disable 1: Follow communication ID (Enable when the active communication ID is 1) 2: Follow communication ID (Enable when the active communication ID is 2) 3: Follow communication ID (Enable when the active communication ID is 3) 4: Follow communication ID (Enable when the active communication ID is 4) 5: Follow communication ID (Enable when the active communication ID is 5) 6: Follow communication ID (Enable when the active communication ID is 6) 7: Follow communication ID (Enable when the active communication ID is 7) 8: Follow communication ID (Enable when the active communication ID is 8) 9: Follow communication ID (Enable when the active communication ID is 9) 10: Follow communication ID (Enable when the active communication ID is 10) 11: Follow communication ID (Enable when the active communication ID is 11) 12: Follow communication ID (Enable when the active communication ID is 12) 13: Follow communication ID (Enable when the active communication ID is 13) 14: Follow communication ID (Enable when the active communication ID is 14) 15: Follow communication ID (Enable when the active communication ID is 15) 16: Follow communication ID (Enable when the active communication ID is 16) 17: Follow communication ID (Enable when the active communication ID is 17) 18: Follow communication ID (Enable when the active communication ID is 18) 19: Follow communication ID (Enable when the active communication ID is 19) 20: Follow communication ID (Enable when the active communication ID is 20) 21: Follow communication ID (Enable when the active communication ID is 21) 22: Follow communication ID (Enable when the active communication ID is 22) 23: Follow communication ID (Enable when the active communication ID is 23) 24: Follow communication ID (Enable when the active communication ID is 24) 25: Follow communication ID (Enable when the active communication ID is 25) 26: Follow communication ID (Enable when the active communication ID is 26) 27: Follow communication ID (Enable when the active communication ID is 27) 28: Follow communication ID (Enable when the active communication ID is 28) 29: Follow communication ID (Enable when the active communication ID is 29) 30: Follow communication ID (Enable when the active communication ID is 30) 31: Follow communication ID (Enable when the active communication ID is 31)</p>	D *1	4	–	495 (01EFh)

Modbus communication register address		Name	Description	Update	Initial setting		NET-ID
Upper	Lower				Initial value	Unit	
994 (03E2h)	995 (03E3h)	Communication I/F mode selection	Sets the communication protocol. [Setting range] –1: Disable 2: Modbus RTU (RS-485 communication) 3: CANopen (CAN) 4: CANopen (CAN) & Modbus RTU (RS-485 communication)	D	4	–	497 (01F1h)
1536 (0600h)	1537 (0601h)	Indirect reference address setting (0)	Sets NET-ID of commands or parameters to be registered in the indirect reference addresses. [Setting range] 0 to 65,535 (0 to FFFFh)	A	0	–	768 (0300h)
1538 (0602h)	1539 (0603h)	Indirect reference address setting (1)		A	0	–	769 (0301h)
1540 (0604h)	1541 (0605h)	Indirect reference address setting (2)		A	0	–	770 (0302h)
1542 (0606h)	1543 (0607h)	Indirect reference address setting (3)		A	0	–	771 (0303h)
1544 (0608h)	1545 (0609h)	Indirect reference address setting (4)		A	0	–	772 (0304h)
1546 (060Ah)	1547 (060Bh)	Indirect reference address setting (5)		A	0	–	773 (0305h)
1548 (060Ch)	1549 (060Dh)	Indirect reference address setting (6)		A	0	–	774 (0306h)
1550 (060Eh)	1551 (060Fh)	Indirect reference address setting (7)		A	0	–	775 (0307h)
1552 (0610h)	1553 (0611h)	Indirect reference address setting (8)		A	0	–	776 (0308h)
1554 (0612h)	1555 (0613h)	Indirect reference address setting (9)		A	0	–	777 (0309h)
1556 (0614h)	1557 (0615h)	Indirect reference address setting (10)		A	0	–	778 (030Ah)
1558 (0616h)	1559 (0617h)	Indirect reference address setting (11)		A	0	–	779 (030Bh)
1560 (0618h)	1561 (0619h)	Indirect reference address setting (12)		A	0	–	780 (030Ch)
1562 (061Ah)	1563 (061Bh)	Indirect reference address setting (13)		A	0	–	781 (030Dh)
1564 (061Ch)	1565 (061Dh)	Indirect reference address setting (14)		A	0	–	782 (030Eh)
1566 (061Eh)	1567 (061Fh)	Indirect reference address setting (15)		A	0	–	783 (030Fh)
1568 (0620h)	1569 (0621h)	Indirect reference address setting (16)		A	0	–	784 (0310h)
1570 (0622h)	1571 (0623h)	Indirect reference address setting (17)		A	0	–	785 (0311h)
1572 (0624h)	1573 (0625h)	Indirect reference address setting (18)		A	0	–	786 (0312h)
1574 (0626h)	1575 (0627h)	Indirect reference address setting (19)		A	0	–	787 (0313h)
1576 (0628h)	1577 (0629h)	Indirect reference address setting (20)		A	0	–	788 (0314h)
1578 (062Ah)	1579 (062Bh)	Indirect reference address setting (21)	A	0	–	789 (0315h)	

Modbus communication register address		Name	Description	Update	Initial setting		NET-ID
Upper	Lower				Initial value	Unit	
1580 (062Ch)	1581 (062Dh)	Indirect reference address setting (22)	Sets NET-ID of commands or parameters to be registered in the indirect reference addresses. [Setting range] 0 to 65,535 (0 to FFFFh)	A	0	–	790 (0316h)
1582 (062Eh)	1583 (062Fh)	Indirect reference address setting (23)		A	0	–	791 (0317h)
1584 (0630h)	1585 (0631h)	Indirect reference address setting (24)		A	0	–	792 (0318h)
1586 (0632h)	1587 (0633h)	Indirect reference address setting (25)		A	0	–	793 (0319h)
1588 (0634h)	1589 (0635h)	Indirect reference address setting (26)		A	0	–	794 (031Ah)
1590 (0636h)	1591 (0637h)	Indirect reference address setting (27)		A	0	–	795 (031Bh)
1592 (0638h)	1593 (0639h)	Indirect reference address setting (28)		A	0	–	796 (031Ch)
1594 (063Ah)	1595 (063Bh)	Indirect reference address setting (29)		A	0	–	797 (031Dh)
1596 (063Ch)	1597 (063Dh)	Indirect reference address setting (30)		A	0	–	798 (031Eh)
1598 (063Eh)	1599 (063Fh)	Indirect reference address setting (31)		A	0	–	799 (031Fh)
1600 (0640h)	1601 (0641h)	Indirect reference address setting (32)		A	0	–	800 (0320h)
1602 (0642h)	1603 (0643h)	Indirect reference address setting (33)		A	0	–	801 (0321h)
1604 (0644h)	1605 (0645h)	Indirect reference address setting (34)		A	0	–	802 (0322h)
1606 (0646h)	1607 (0647h)	Indirect reference address setting (35)		A	0	–	803 (0323h)
1608 (0648h)	1609 (0649h)	Indirect reference address setting (36)		A	0	–	804 (0324h)
1610 (064Ah)	1611 (064Bh)	Indirect reference address setting (37)		A	0	–	805 (0325h)
1612 (064Ch)	1613 (064Dh)	Indirect reference address setting (38)		A	0	–	806 (0326h)
1614 (064Eh)	1615 (064Fh)	Indirect reference address setting (39)		A	0	–	807 (0327h)
1616 (0650h)	1617 (0651h)	Indirect reference address setting (40)		A	0	–	808 (0328h)
1618 (0652h)	1619 (0653h)	Indirect reference address setting (41)		A	0	–	809 (0329h)
1620 (0654h)	1621 (0655h)	Indirect reference address setting (42)		A	0	–	810 (032Ah)
1622 (0656h)	1623 (0657h)	Indirect reference address setting (43)		A	0	–	811 (032Bh)
1624 (0658h)	1625 (0659h)	Indirect reference address setting (44)		A	0	–	812 (032Ch)
1626 (065Ah)	1627 (065Bh)	Indirect reference address setting (45)		A	0	–	813 (032Dh)
1628 (065Ch)	1629 (065Dh)	Indirect reference address setting (46)		A	0	–	814 (032Eh)

Modbus communication register address		Name	Description	Update	Initial setting		NET-ID
Upper	Lower				Initial value	Unit	
1630 (065Eh)	1631 (065Fh)	Indirect reference address setting (47)	Sets NET-ID of commands or parameters to be registered in the indirect reference addresses. [Setting range] 0 to 65,535 (0 to FFFFh)	A	0	–	815 (032Fh)
1632 (0660h)	1633 (0661h)	Indirect reference address setting (48)		A	0	–	816 (0330h)
1634 (0662h)	1635 (0663h)	Indirect reference address setting (49)		A	0	–	817 (0331h)
1636 (0664h)	1637 (0665h)	Indirect reference address setting (50)		A	0	–	818 (0332h)
1638 (0666h)	1639 (0667h)	Indirect reference address setting (51)		A	0	–	819 (0333h)
1640 (0668h)	1641 (0669h)	Indirect reference address setting (52)		A	0	–	820 (0334h)
1642 (066Ah)	1643 (066Bh)	Indirect reference address setting (53)		A	0	–	821 (0335h)
1644 (066Ch)	1645 (066Dh)	Indirect reference address setting (54)		A	0	–	822 (0336h)
1646 (066Eh)	1647 (066Fh)	Indirect reference address setting (55)		A	0	–	823 (0337h)
1648 (0670h)	1649 (0671h)	Indirect reference address setting (56)		A	0	–	824 (0338h)
1650 (0672h)	1651 (0673h)	Indirect reference address setting (57)		A	0	–	825 (0339h)
1652 (0674h)	1653 (0675h)	Indirect reference address setting (58)		A	0	–	826 (033Ah)
1654 (0676h)	1655 (0677h)	Indirect reference address setting (59)		A	0	–	827 (033Bh)
1656 (0678h)	1657 (0679h)	Indirect reference address setting (60)		A	0	–	828 (033Ch)
1658 (067Ah)	1659 (067Bh)	Indirect reference address setting (61)		A	0	–	829 (033Dh)
1660 (067Ch)	1661 (067Dh)	Indirect reference address setting (62)		A	0	–	830 (033Eh)
1662 (067Eh)	1663 (067Fh)	Indirect reference address setting (63)		A	0	–	831 (033Fh)
1664 (0680h)	1665 (0681h)	Indirect reference address setting (64)		A	0	–	832 (0340h)
1666 (0682h)	1667 (0683h)	Indirect reference address setting (65)		A	0	–	833 (0341h)
1668 (0684h)	1669 (0685h)	Indirect reference address setting (66)		A	0	–	834 (0342h)
1670 (0686h)	1671 (0687h)	Indirect reference address setting (67)		A	0	–	835 (0343h)
1672 (0688h)	1673 (0689h)	Indirect reference address setting (68)	A	0	–	836 (0344h)	
1674 (068Ah)	1675 (068Bh)	Indirect reference address setting (69)	A	0	–	837 (0345h)	
1676 (068Ch)	1677 (068Dh)	Indirect reference address setting (70)	A	0	–	838 (0346h)	
1678 (068Eh)	1679 (068Fh)	Indirect reference address setting (71)	A	0	–	839 (0347h)	

Modbus communication register address		Name	Description	Update	Initial setting		NET-ID
Upper	Lower				Initial value	Unit	
1680 (0690h)	1681 (0691h)	Indirect reference address setting (72)	Sets NET-ID of commands or parameters to be registered in the indirect reference addresses. [Setting range] 0 to 65,535 (0 to FFFFh)	A	0	–	840 (0348h)
1682 (0692h)	1683 (0693h)	Indirect reference address setting (73)		A	0	–	841 (0349h)
1684 (0694h)	1685 (0695h)	Indirect reference address setting (74)		A	0	–	842 (034Ah)
1686 (0696h)	1687 (0697h)	Indirect reference address setting (75)		A	0	–	843 (034Bh)
1688 (0698h)	1689 (0699h)	Indirect reference address setting (76)		A	0	–	844 (034Ch)
1690 (069Ah)	1691 (069Bh)	Indirect reference address setting (77)		A	0	–	845 (034Dh)
1692 (069Ch)	1693 (069Dh)	Indirect reference address setting (78)		A	0	–	846 (034Eh)
1694 (069Eh)	1695 (069Fh)	Indirect reference address setting (79)		A	0	–	847 (034Fh)
1696 (06A0h)	1697 (06A1h)	Indirect reference address setting (80)		A	0	–	848 (0350h)
1698 (06A2h)	1699 (06A3h)	Indirect reference address setting (81)		A	0	–	849 (0351h)
1700 (06A4h)	1701 (06A5h)	Indirect reference address setting (82)		A	0	–	850 (0352h)
1702 (06A6h)	1703 (06A7h)	Indirect reference address setting (83)		A	0	–	851 (0353h)
1704 (06A8h)	1705 (06A9h)	Indirect reference address setting (84)		A	0	–	852 (0354h)
1706 (06AAh)	1707 (06ABh)	Indirect reference address setting (85)		A	0	–	853 (0355h)
1708 (06ACh)	1709 (06ADh)	Indirect reference address setting (86)		A	0	–	854 (0356h)
1710 (06AEh)	1711 (06AFh)	Indirect reference address setting (87)		A	0	–	855 (0357h)
1712 (06B0h)	1713 (06B1h)	Indirect reference address setting (88)		A	0	–	856 (0358h)
1714 (06B2h)	1715 (06B3h)	Indirect reference address setting (89)		A	0	–	857 (0359h)
1716 (06B4h)	1717 (06B5h)	Indirect reference address setting (90)		A	0	–	858 (035Ah)
1718 (06B6h)	1719 (06B7h)	Indirect reference address setting (91)		A	0	–	859 (035Bh)
1720 (06B8h)	1721 (06B9h)	Indirect reference address setting (92)		A	0	–	860 (035Ch)
1722 (06BAh)	1723 (06BBh)	Indirect reference address setting (93)		A	0	–	861 (035Dh)
1724 (06BCh)	1725 (06BDh)	Indirect reference address setting (94)		A	0	–	862 (035Eh)
1726 (06BEh)	1727 (06BFh)	Indirect reference address setting (95)		A	0	–	863 (035Fh)
1728 (06C0h)	1729 (06C1h)	Indirect reference address setting (96)		A	0	–	864 (0360h)

Modbus communication register address		Name	Description	Update	Initial setting		NET-ID
Upper	Lower				Initial value	Unit	
1730 (06C2h)	1731 (06C3h)	Indirect reference address setting (97)	Sets NET-ID of commands or parameters to be registered in the indirect reference addresses. [Setting range] 0 to 65,535 (0 to FFFFh)	A	0	–	865 (0361h)
1732 (06C4h)	1733 (06C5h)	Indirect reference address setting (98)		A	0	–	866 (0362h)
1734 (06C6h)	1735 (06C7h)	Indirect reference address setting (99)		A	0	–	867 (0363h)
1736 (06C8h)	1737 (06C9h)	Indirect reference address setting (100)		A	0	–	868 (0364h)
1738 (06CAh)	1739 (06CBh)	Indirect reference address setting (101)		A	0	–	869 (0365h)
1740 (06CCh)	1741 (06CDh)	Indirect reference address setting (102)		A	0	–	870 (0366h)
1742 (06CEh)	1743 (06CFh)	Indirect reference address setting (103)		A	0	–	871 (0367h)
1744 (06D0h)	1745 (06D1h)	Indirect reference address setting (104)		A	0	–	872 (0368h)
1746 (06D2h)	1747 (06D3h)	Indirect reference address setting (105)		A	0	–	873 (0369h)
1748 (06D4h)	1749 (06D5h)	Indirect reference address setting (106)		A	0	–	874 (036Ah)
1750 (06D6h)	1751 (06D7h)	Indirect reference address setting (107)		A	0	–	875 (036Bh)
1752 (06D8h)	1753 (06D9h)	Indirect reference address setting (108)		A	0	–	876 (036Ch)
1754 (06DAh)	1755 (06DBh)	Indirect reference address setting (109)		A	0	–	877 (036Dh)
1756 (06DCh)	1757 (06DDh)	Indirect reference address setting (110)		A	0	–	878 (036Eh)
1758 (06DEh)	1759 (06DFh)	Indirect reference address setting (111)		A	0	–	879 (036Fh)
1760 (06E0h)	1761 (06E1h)	Indirect reference address setting (112)		A	0	–	880 (0370h)
1762 (06E2h)	1763 (06E3h)	Indirect reference address setting (113)		A	0	–	881 (0371h)
1764 (06E4h)	1765 (06E5h)	Indirect reference address setting (114)		A	0	–	882 (0372h)
1766 (06E6h)	1767 (06E7h)	Indirect reference address setting (115)		A	0	–	883 (0373h)
1768 (06E8h)	1769 (06E9h)	Indirect reference address setting (116)		A	0	–	884 (0374h)
1770 (06EAh)	1771 (06EBh)	Indirect reference address setting (117)		A	0	–	885 (0375h)
1772 (06ECh)	1773 (06EDh)	Indirect reference address setting (118)	A	0	–	886 (0376h)	
1774 (06EEh)	1775 (06EFh)	Indirect reference address setting (119)	A	0	–	887 (0377h)	
1776 (06F0h)	1777 (06F1h)	Indirect reference address setting (120)	A	0	–	888 (0378h)	
1778 (06F2h)	1779 (06F3h)	Indirect reference address setting (121)	A	0	–	889 (0379h)	

Modbus communication register address		Name	Description	Update	Initial setting		NET-ID
Upper	Lower				Initial value	Unit	
1780 (06F4h)	1781 (06F5h)	Indirect reference address setting (122)	Sets NET-ID of commands or parameters to be registered in the indirect reference addresses. [Setting range] 0 to 65,535 (0 to FFFFh)	A	0	–	890 (037Ah)
1782 (06F6h)	1783 (06F7h)	Indirect reference address setting (123)		A	0	–	891 (037Bh)
1784 (06F8h)	1785 (06F9h)	Indirect reference address setting (124)		A	0	–	892 (037Ch)
1786 (06FAh)	1787 (06FBh)	Indirect reference address setting (125)		A	0	–	893 (037Dh)
1788 (06FCh)	1789 (06FDh)	Indirect reference address setting (126)		A	0	–	894 (037Eh)
1790 (06FEh)	1791 (06FFh)	Indirect reference address setting (127)		A	0	–	895 (037Fh)
4992 (1380h)	4993 (1381h)	Slave address (Modbus)	Sets the address number (slave address). [Setting range] –1: Follow ID-SEL input (ID = ID-SEL value + 1) 1 to 31: Slave addresses 1 to 31 Do not use 0.	D *1	–1	–	2496 (09C0h)
4994 (1382h)	4995 (1383h)	Baudrate (Modbus)	Sets the transmission rate. [Setting range] 0: 9,600 bps 1: 19,200 bps 2: 38,400 bps 3: 57,600 bps 4: 115,200 bps 5: 230,400 bps	D *1	5	–	2497 (09C1h)
4996 (1384h)	4997 (1385h)	Byte & word order (Modbus)	Sets the byte order of 32-bit data. Set when the arrangement of communication data is different from the master. (Setting example ⇨ p.215) [Setting range] 0: Even Address-High Word & Big-Endian 1: Even Address-Low Word & Big-Endian 2: Even Address-High Word & Little-Endian 3: Even Address-Low Word & Little-Endian	D *1	0	–	2498 (09C2h)
4998 (1386h)	4999 (1387h)	Communication parity (Modbus)	Sets the communication parity. [Setting range] 0: None 1: Even parity 2: Odd parity	D *1	1	–	2499 (09C3h)
5000 (1388h)	5001 (1389h)	Communication stop bit (Modbus)	Sets the communication stop bit. [Setting range] 0: 1 bit 1: 2 bits	D *1	0	–	2500 (09C4h)
5002 (138Ah)	5003 (138Bh)	Communication timeout (Modbus)	Sets the condition in which a communication timeout occurs in RS-485 communication. [Setting range] 0: Not monitored 1 to 10,000 ms	A	0	–	2501 (09C5h)

Modbus communication register address		Name	Description	Update	Initial setting		NET-ID
Upper	Lower				Initial value	Unit	
5004 (138Ch)	5005 (138Dh)	Communication error detection (Modbus)	A communication error alarm is generated when the RS-485 communication error has occurred by the number of times set here. [Setting range] 0: Disable 1 to 10 times	A	3	–	2502 (09C6h)
5006 (138Eh)	5007 (138Fh)	Transmission waiting time (Modbus)	This is a parameter to set the transmission waiting time. [Setting range] 0 to 10,000 (1=0.1 ms)	D *1	30	1=0.1 ms	2503 (09C7h)
5008 (1390h)	5009 (1391h)	Silent interval (Modbus)	Sets the silent interval. [Setting range] 0: Set automatically 1 to 100 (1=0.1 ms)	D *1	0	–	2504 (09C8h)
5010 (1392h)	5011 (1393h)	Slave error response mode (Modbus)	Sets the response when the slave error occurred. [Setting range] 0: Normal response 1: Exception response	A	1	–	2505 (09C9h)
5012 (1394h)	5013 (1395h)	Initial group ID (Modbus)	Sets the address of a group (address number of parent slave). [Setting range] –1: Disable (no group transmission) 1 to 31: Group ID Do not use 0.	C	–1	–	2506 (09CAh)
5056 (13C0h)	5057 (13C1h)	RS-485 communication frame monitor target ID	Sets the monitor axis in the RS-485 communication frame monitor of the support software. [Setting range] 1 to 127: Slave address 1 to 127	A	1	–	2528 (09E0h)
5080 (13D8h)	5081 (13D9h)	CANopen EDS *2	Selects the EDS file matched. [Setting range] 0: EDS Version 1.00 1: EDS Version 2.00	D	1	–	2540 (09ECh)
34304 (8600h)	34305 (8601h)	CANopen Node-ID	Sets the CANopen Node-ID. [Setting range] –1: Follow ID-SEL input (ID = ID-SEL + 1) 1 to 127: Node-ID 1 to 127	D *1	–1	–	17152 (4300h)
34306 (8602h)	34307 (8603h)	CANopen Bitrate	Sets the CANopen Bitrate. [Setting range] 0: 10kbps 1: 20kbps 2: 50kbps 3: 125kbps 4: 250kbps 5: 500kbps 6: 800kbps 7: 1000kbps	D *1	5	–	17153 (4301h)

*1 When writing is performed with the support software, the value written is immediately updated.

*2 It is effective for the driver version 3.00 or later.

13-4 Communication setting (Modbus/CANopen) (compatible)

Modbus communication register address		Name	Description	Update	Initial setting		NET-ID
Upper	Lower				Initial value	Unit	
4864 (1300h)	4865 (1301h)	Indirect reference address setting (0) (compatible)	Sets NET-ID of commands or parameters to be registered in the indirect reference addresses. [Setting range] 0 to 65,535 (0 to FFFFh)	A	0	–	2432 (0980h)
4866 (1302h)	4867 (1303h)	Indirect reference address setting (1) (compatible)		A	0	–	2433 (0981h)
4868 (1304h)	4869 (1305h)	Indirect reference address setting (2) (compatible)		A	0	–	2434 (0982h)
4870 (1306h)	4871 (1307h)	Indirect reference address setting (3) (compatible)		A	0	–	2435 (0983h)
4872 (1308h)	4873 (1309h)	Indirect reference address setting (4) (compatible)		A	0	–	2436 (0984h)
4874 (130Ah)	4875 (130Bh)	Indirect reference address setting (5) (compatible)		A	0	–	2437 (0985h)
4876 (130Ch)	4877 (130Dh)	Indirect reference address setting (6) (compatible)		A	0	–	2438 (0986h)
4878 (130Eh)	4879 (130Fh)	Indirect reference address setting (7) (compatible)		A	0	–	2439 (0987h)
4880 (1310h)	4881 (1311h)	Indirect reference address setting (8) (compatible)		A	0	–	2440 (0988h)
4882 (1312h)	4883 (1313h)	Indirect reference address setting (9) (compatible)		A	0	–	2441 (0989h)
4884 (1314h)	4885 (1315h)	Indirect reference address setting (10) (compatible)		A	0	–	2442 (098Ah)
4886 (1316h)	4887 (1317h)	Indirect reference address setting (11) (compatible)		A	0	–	2443 (098Bh)
4888 (1318h)	4889 (1319h)	Indirect reference address setting (12) (compatible)		A	0	–	2444 (098Ch)
4890 (131Ah)	4891 (131Bh)	Indirect reference address setting (13) (compatible)		A	0	–	2445 (098Dh)
4892 (131Ch)	4893 (131Dh)	Indirect reference address setting (14) (compatible)		A	0	–	2446 (098Eh)
4894 (131Eh)	4895 (131Fh)	Indirect reference address setting (15) (compatible)		A	0	–	2447 (098Fh)
4896 (1320h)	4897 (1321h)	Indirect reference address setting (16) (compatible)		A	0	–	2448 (0990h)
4898 (1322h)	4899 (1323h)	Indirect reference address setting (17) (compatible)		A	0	–	2449 (0991h)
4900 (1324h)	4901 (1325h)	Indirect reference address setting (18) (compatible)		A	0	–	2450 (0992h)
4902 (1326h)	4903 (1327h)	Indirect reference address setting (19) (compatible)		A	0	–	2451 (0993h)
4904 (1328h)	4905 (1329h)	Indirect reference address setting (20) (compatible)		A	0	–	2452 (0994h)
4906 (132Ah)	4907 (132Bh)	Indirect reference address setting (21) (compatible)		A	0	–	2453 (0995h)
4908 (132Ch)	4909 (132Dh)	Indirect reference address setting (22) (compatible)		A	0	–	2454 (0996h)
4910 (132Eh)	4911 (132Fh)	Indirect reference address setting (23) (compatible)	A	0	–	2455 (0997h)	

Modbus communication register address		Name	Description	Update	Initial setting		NET-ID
Upper	Lower				Initial value	Unit	
4912 (1330h)	4913 (1331h)	Indirect reference address setting (24) (compatible)	Sets NET-ID of commands or parameters to be registered in the indirect reference addresses. [Setting range] 0 to 65,535 (0 to FFFFh)	A	0	–	2456 (0998h)
4914 (1332h)	4915 (1333h)	Indirect reference address setting (25) (compatible)		A	0	–	2457 (0999h)
4916 (1334h)	4917 (1335h)	Indirect reference address setting (26) (compatible)		A	0	–	2458 (099Ah)
4918 (1336h)	4919 (1337h)	Indirect reference address setting (27) (compatible)		A	0	–	2459 (099Bh)
4920 (1338h)	4921 (1339h)	Indirect reference address setting (28) (compatible)		A	0	–	2460 (099Ch)
4922 (133Ah)	4923 (133Bh)	Indirect reference address setting (29) (compatible)		A	0	–	2461 (099Dh)
4924 (133Ch)	4925 (133Dh)	Indirect reference address setting (30) (compatible)		A	0	–	2462 (099Eh)
4926 (133Eh)	4927 (133Fh)	Indirect reference address setting (31) (compatible)		A	0	–	2463 (099Fh)

13-5 Modbus ID share mode setting

Modbus communication register address		Name	Description	Update	Initial setting		NET-ID
Upper	Lower				Initial value	Unit	
2432 (0980h)	2433 (0981h)	Share control global ID	Sets the communication ID used in the ID share mode. [Setting range] –1: ID share mode is not used 1 to 127: Communication ID to share	A	–1	–	1216 (04C0h)
2434 (0982h)	2435 (0983h)	Share control number	Sets the number of slave axes used in the ID share mode. [Setting range] 1 to 31	A	1	–	1217 (04C1h)
2436 (0984h)	2437 (0985h)	Share Control Local ID	Sets the ID for identifying the slave used in the ID share mode. [Setting range] 0: ID share mode is not used 1 to 31: ID for slave identification	A	0	–	1218 (04C2h)
2448 (0990h)	2449 (0991h)	Share Read data 0	Sets the NET-ID of data to be read in the ID share mode. [Setting range] Refer to p.285.	A	0	–	1224 (04C8h)
2450 (0992h)	2451 (0993h)	Share Read data 1		A	0	–	1225 (04C9h)
2452 (0994h)	2453 (0995h)	Share Read data 2		A	0	–	1226 (04CAh)
2454 (0996h)	2455 (0997h)	Share Read data 3		A	0	–	1227 (04CBh)
2456 (0998h)	2457 (0999h)	Share Read data 4		A	0	–	1228 (04CCh)
2458 (099Ah)	2459 (099Bh)	Share Read data 5		A	0	–	1229 (04CDh)

Modbus communication register address		Name	Description	Update	Initial setting		NET-ID
Upper	Lower				Initial value	Unit	
2460 (099Ch)	2461 (099Dh)	Share Read data 6	Sets the NET-ID of data to be read in the ID share mode. [Setting range] Refer to p.285.	A	0	–	1230 (04CEh)
2462 (099Eh)	2463 (099Fh)	Share Read data 7		A	0	–	1231 (04CFh)
2464 (09A0h)	2465 (09A1h)	Share Read data 8		A	0	–	1232 (04D0h)
2466 (09A2h)	2467 (09A3h)	Share Read data 9		A	0	–	1233 (04D1h)
2468 (09A4h)	2469 (09A5h)	Share Read data 10		A	0	–	1234 (04D2h)
2470 (09A6h)	2471 (09A7h)	Share Read data 11		A	0	–	1235 (04D3h)
2472 (09A8h)	2473 (09A9h)	Share Write data 0	Sets the NET-ID of data to be written in the ID share mode. [Setting range] Refer to p.285.	A	0	–	1236 (04D4h)
2474 (09AAh)	2475 (09ABh)	Share Write data 1		A	0	–	1237 (04D5h)
2476 (09ACh)	2477 (09ADh)	Share Write data 2		A	0	–	1238 (04D6h)
2478 (09AEh)	2479 (09AFh)	Share Write data 3		A	0	–	1239 (04D7h)
2480 (09B0h)	2481 (09B1h)	Share Write data 4		A	0	–	1240 (04D8h)
2482 (09B2h)	2483 (09B3h)	Share Write data 5		A	0	–	1241 (04D9h)
2484 (09B4h)	2485 (09B5h)	Share Write data 6		A	0	–	1242 (04DAh)
2486 (09B6h)	2487 (09B7h)	Share Write data 7		A	0	–	1243 (04DBh)
2488 (09B8h)	2489 (09B9h)	Share Write data 8		A	0	–	1244 (04DCh)
2490 (09BAh)	2491 (09BBh)	Share Write data 9		A	0	–	1245 (04DDh)
2492 (09BCh)	2493 (09BDh)	Share Write data 10		A	0	–	1246 (04DEh)
2494 (09BEh)	2495 (09BFh)	Share Write data 11	A	0	–	1247 (04DFh)	

13-6 Power removal setting, ETO setting, and alarm setting

Modbus communication register address		Name	Description	Update	Initial setting		NET-ID
Upper	Lower				Initial value	Unit	
770 (0302h)	771 (0303h)	Position deviation alarm (user setting)	Sets the condition in which the position deviation alarm is generated. *1 [Setting range] 0 to 10,000,000 (User-defined position unit)	A	108,000	step	385 (0181h)
778 (030Ah)	779 (030Bh)	Stopping method at alarm generation	Sets how to stop the motor when an alarm which motor excitation state is "Excitation" or "Non-excitation after deceleration" is generated. [Setting range] 0: Immediate stop 1: Deceleration rate stop (according to the operation profile during operation) 2: Follow QSTOP setting (the excitation state is according to the alarm specifications)	A	2	—	389 (0185h)
780 (030Ch)	781 (030Dh)	Stopping timeout at alarm generation	Sets the time-out period from when the alarm of "Non-excitation after deceleration" is generated until the excitation is turned off. [Setting range] 0 to 10,000 ms	A	3,000	ms	390 (0186h)
782 (030Eh)	783 (030Fh)	Overvoltage alarm (user setting)	Sets the condition in which the overvoltage alarm is generated. *1 [Setting range] 0: Disable *2 1 to 720 (1=0.1V)	A	0	1=0.1 V	391 (0187h)
784 (0310h)	785 (0311h)	Overvoltage alarm (main power supply voltage differential conditions)	Sets the condition in which the overvoltage alarm is generated. *1 [Setting range] 0: Disable *2 1 to 450 (1=0.1V)	A	0	1=0.1 V	392 (0188h)
800 (0320h)	801 (0321h)	Occur alarm at HWTO input OFF	Sets whether to generate an alarm of "HWTO input detection" when both the HWTO1 and HWTO2 inputs are turned OFF. [Setting range] 0: Disable 1: Enable	A	0	—	400 (0190h)
802 (0322h)	803 (0323h)	HWTO delay time of checking dual system	Sets a threshold from when either the HWTO1 input or the HWTO2 input is turned OFF until the other input is turned OFF. If the other input is not turned OFF even when the threshold is exceeded, an alarm is generated. [Setting range] 0 to 10: Disable 11 to 100 ms	A	0	—	401 (0191h)

Modbus communication register address		Name	Description	Update	Initial setting		NET-ID
Upper	Lower				Initial value	Unit	
816 (0330h)	817 (0331h)	ETO reset ineffective period	Sets the time from when the driver transitions to the ETO status until it can release the ETO status. [Setting range] 0 to 100 ms	A	0	ms	408 (0198h)
818 (0332h)	819 (0333h)	ETO reset action (ETO-CLR)	Sets the judgment criterion of the signal when the ETO status is released by the ETO-CLR input. [Setting range] 1: ON edge (Positive edge) 2: ON level	A	1	–	409 (0199h)
820 (0334h)	821 (0335h)	ETO reset action (ALM-RST)	Enables to release the ETO status by the ALM-RST input. [Setting range] 0: Disable 1: ON edge (Positive edge)	A	0	–	410 (019Ah)
822 (0336h)	823 (0337h)	ETO reset action (S-ON)	Enables to release the ETO status by the S-ON input. [Setting range] 0: Disable 1: ON edge (Positive edge)	A	1	–	411 (019Bh)
824 (0338h)	825 (0339h)	ETO reset action (STOP)	Enables to release the ETO status by the STOP input. [Setting range] 0: Disable 1: ON edge (Positive edge)	A	1	–	412 (019Ch)
5076 (13D4h)	5077 (13D5h)	User alarm action *3	Sets whether or not to excite the motor after stop when the user alarm is generated. [Setting range] 0: Non-excitation after deceleration 1: Excitation	A	0	–	2538 (09EAh)

*1 If a value larger than the condition to generate the alarm is set, an alarm will be generated base on the condition in which the alarm is generated.

*2 If it is set to "Disable," the condition in which the overvoltage alarm is generated is applied.

*3 It is effective for the driver version 3.00 or later.

13-7 I/O operation and function

Modbus communication register address		Name	Description	Update	Initial setting		NET-ID
Upper	Lower				Initial value	Unit	
3586 (0E02h)	3587 (0E03h)	FW-LS/RV-LS input action	Sets how to stop the motor when the FW-LS input or the RV-LS input is turned ON. [Setting range] –1: Only for homing sensor 0: Immediate stop 1: Deceleration rate stop (according to the operation profile during operation) 2: Follow QSTOP setting (current is not cut off) 3: Follow STOP setting 4: Immediate stop with alarm 5: Deceleration stop with alarm (according to the operation profile during operation) 6: Follow QSTOP setting with alarm (current is not cut off) 7: Follow STOP setting with alarm	A	4	–	1793 (0701h)
3588 (0E04h)	3589 (0E05h)	FW-BLK/RV-BLK input action	Sets how to stop the motor when the FW-BLK input or the RV-BLK input is turned ON. [Setting Range] 0: Immediate stop 1: Deceleration stop (according to the operation profile during operation) 2: Follow QSTOP setting (current is not cut off) 3: Follow STOP setting	A	1	–	1794 (0702h)
3590 (0E06h)	3591 (0E07h)	IN-POS positioning completion signal range	Sets the output range (one side) of the IN-POS output with the target position as a center. [Setting range] 0 to 65,535 (User-defined position unit)	A	18	step	1795 (0703h)
3594 (0E0Ah)	3595 (0E0Bh)	D-SEL drive start function	Sets whether to start operation when the D-SEL input is turned ON. [Setting range] 0: Operation data number selection only 1: Operation data number selection + START function	A	1	–	1797 (0705h)
3598 (0E0Eh)	3599 (0E0Fh)	ZSG signal width	Sets the output width of the ZSG-N output. [Setting range] 1 to 7200 (1=0.01°)	A	180	1=0.01°	1799 (0707h)
3600 (0E10h)	3601 (0E11h)	WRAP-ZERO signal width	Sets the output width of the WRAP-ZERO output. [Setting range] 1 to 10,000 (User-defined position unit)	A	10	step	1800 (0708h)
3602 (0E12h)	3603 (0E13h)	WRAP-ZERO signal base setting	Sets the criterion of the WRAP-ZERO output. [Setting range] 0: Based on actual position 1: Based on demand position	A	0	–	1801 (0709h)

Modbus communication register address		Name	Description	Update	Initial setting		NET-ID
Upper	Lower				Initial value	Unit	
3604 (0E14h)	3605 (0E15h)	MOVE minimum ON time	Sets the minimum time during which the MOVE output remains ON. The minimum ON time is guaranteed when the output time of the MOVE signal is short, such as when the operating time is short. [Setting range] 0 to 255 ms	A	0	ms	1802 (070Ah)
3610 (0E1Ah)	3611 (0E1Bh)	TRQ-LMT input torque limit value	Sets the torque to be limited by the TRQ-LMT input. Set the percentage of the torque based on the rated torque being 100%. [Setting range] 0 to 10,000 (1=0.1%)	A	500	1=0.1%	1805 (070Dh)
3612 (0E1Ch)	3613 (0E1Dh)	SPD-LMT speed limit type selection	Selects the setting method of the speed limit value. [Setting range] 0: Ratio 1: Value	A	0	–	1806 (070Eh)
3614 (0E1Eh)	3615 (0E1Fh)	SPD-LMT speed limit ratio	Sets the percentage of the speed limit based on the "Operating velocity" of the operation profile being 100%. This is enabled when the "SPD-LMT speed limit type selection" parameter is set to "Ratio." [Setting range] 1 to 100%	A	50	%	1807 (070Fh)
3616 (0E20h)	3617 (0E21h)	SPD-LMT speed limit value	Sets the value of the operating velocity. This is enabled when the "SPD-LMT speed limit type selection" parameter is set to "Value." [Setting range] 1 to 4,000,000 (User-defined velocity unit)	A	1,000	r/min	1808 (0710h)
3632 (0E30h)	3633 (0E31h)	VA mode selection	Selects the judgment criterion of the VA output. [Setting range] 0: Actual velocity attainment 1: Profile demand velocity attainment 2: Velocity attainment (actual velocity & profile demand velocity)	A	0	–	1816 (0718h)
3634 (0E32h)	3635 (0E33h)	VA detection speed range	Sets the output range (one side) of the VA output with the target speed as a center. [Setting range] 0 to 65,535 (User-defined velocity unit)	A	15	r/min	1817 (0719h)
3636 (0E34h)	3637 (0E35h)	MAREA output source	Sets the criterion to turn the MAREA output ON and the status of the MAREA output after operation. [Setting range] 0: Based on actual position (ON after operation) 1: Based on demand position (ON after operation) 2: Based on actual position (MAREA output OFF at completion) 3: Based on demand position (MAREA output OFF at completion)	A	0	–	1818 (071Ah)
3638 (0E36h)	3639 (0E37h)	Automatic S-ON for the FW/RV operation	Selects the setting that automatically turns the S-ON input ON in FW/RV operation. [Setting range] 0: Disable 1: Enable	A	0	–	1819 (071Bh)

Modbus communication register address		Name	Description	Update	Initial setting		NET-ID
Upper	Lower				Initial value	Unit	
3640 (0E38h)	3641 (0E39h)	Accept stored data override operation start by START input	Selects whether to start operation using the START input while operating. When the function of the D-SEL input is set to "Operation data number selection + START function," the D-SEL is also applied. [Setting range] 0: Disable 1: Enable	A	0	–	1820 (071Ch)
3642 (0E3Ah)	3643 (0E3Bh)	ZV detection speed range	Sets the output range (one side) of the ZV output with the operating velocity 0 as a center. [Setting range] 0 to 65,535 (User-defined velocity unit)	A	15	r/min	1821 (071Dh)
3680 (0E60h)	3681 (0E61h)	STOP input action	Sets how to stop the motor when the STOP input is turned ON. [Setting range] –3: Deceleration time stop (according to the Custom stopping time parameter) –2: Deceleration rate stop (according to the Custom stopping rate parameter) –1: Immediate stop 1: Deceleration stop (according to the operation profile during operation except for the torque limiting value) 2: Deceleration rate stop (according to the Quick stop rate parameter)	A	1	–	1840 (0730h)
3682 (0E62h)	3683 (0E63h)	STOP input stopping torque limiting value	Sets the torque limiting value when the STOP input is turned ON. [Setting range] 0: Use profile torque limit continuously 1 to 10,000 (1=0.1%)	A	0	1=0.1%	1841 (0731h)

Modbus communication register address		Name	Description	Update	Initial setting		NET-ID
Upper	Lower				Initial value	Unit	
3684 (0E64h)	3685 (0E65h)	QSTOP input action	<p>Sets how to stop the motor when the QSTOP input is turned ON.</p> <p>[Setting range] –3: Deceleration time stop (according to the Custom stopping time parameter) –2: Deceleration rate stop (according to the Custom stopping rate parameter) –1: Immediate stop 0: Immediate stop (current is cut off after stopping) 1: Deceleration stop (according to the operation profile during operation except for the torque limiting value) (current is cut off after stopping) 2: Deceleration rate stop (according to the Quick stop rate parameter) (current is cut off after stopping) 5: Deceleration stop (according to the operation profile during operation except for the torque limiting value) 6: Deceleration rate stop (according to the Quick stop rate parameter)</p>	A	2	–	1842 (0732h)
3686 (0E66h)	3687 (0E67h)	QSTOP input stopping torque limiting value	<p>Sets the torque limiting value when the QSTOP input is turned ON.</p> <p>[Setting range] 0: Use profile torque limit continuously 1 to 10,000 (1=0.1%)</p>	A	0	1=0.1%	1843 (0733h)
3688 (0E68h)	3689 (0E69h)	Quick stop rate	<p>Sets the deceleration rate when "Deceleration rate stop (according to the Quick stop rate parameter)" is selected in the "STOP input action" and "QSTOP input action" parameters.</p> <p>[Setting range] 1 to 1,000,000,000 (User-defined velocity unit/s)</p>	A	1,000	(r/min)/s	1844 (0734h)
3690 (0E6Ah)	3691 (0E6Bh)	Custom stopping rate	<p>Sets the deceleration rate when "Deceleration rate stop (according to the Custom stopping rate parameter)" is selected in the "STOP input action" and "QSTOP input action" parameters.</p> <p>[Setting range] 1 to 1,000,000,000 (User-defined velocity unit/s)</p>	A	1,000	(r/min)/s	1845 (0735h)
3692 (0E6Ch)	3693 (0E6Dh)	Custom stopping time	<p>Sets the deceleration time when "Deceleration time stop (according to the Custom stopping time parameter)" is selected in the "STOP input action" and "QSTOP input action" parameters.</p> <p>[Setting range] 1 to 1,000,000,000 ms</p>	A	1,000	ms	1846 (0736h)
3712 (0E80h)	3713 (0E81h)	AREA0 positive direction position/offset	<p>Sets the positive direction position or offset from the target position for the AREA0 output.</p> <p>[Setting range] –2,147,483,648 to 2,147,483,647 (User-defined position unit)</p>	A	0	step	1856 (0740h)

Modbus communication register address		Name	Description	Update	Initial setting		NET-ID
Upper	Lower				Initial value	Unit	
3714 (0E82h)	3715 (0E83h)	AREA0 negative direction position/detection range	Sets the negative direction position or distance from the offset position for the AREA0 output. [Setting range] –2,147,483,648 to 2,147,483,647 (User-defined position unit)	A	0	step	1857 (0741h)
3716 (0E84h)	3717 (0E85h)	AREA1 positive direction position/offset	Sets the positive direction position or offset from the target position for the AREA1 output. [Setting range] –2,147,483,648 to 2,147,483,647 (User-defined position unit)	A	0	step	1858 (0742h)
3718 (0E86h)	3719 (0E87h)	AREA1 negative direction position/detection range	Sets the negative direction position or distance from the offset position for the AREA1 output. [Setting range] –2,147,483,648 to 2,147,483,647 (User-defined position unit)	A	0	step	1859 (0743h)
3720 (0E88h)	3721 (0E89h)	AREA2 positive direction position/offset	Sets the positive direction position or offset from the target position for the AREA2 output. [Setting range] –2,147,483,648 to 2,147,483,647 (User-defined position unit)	A	0	step	1860 (0744h)
3722 (0E8Ah)	3723 (0E8Bh)	AREA2 negative direction position/detection range	Sets the negative direction position or distance from the offset position for the AREA2 output. [Setting range] –2,147,483,648 to 2,147,483,647 (User-defined position unit)	A	0	step	1861 (0745h)
3724 (0E8Ch)	3725 (0E8Dh)	AREA3 positive direction position/offset	Sets the positive direction position or offset from the target position for the AREA3 output. [Setting range] –2,147,483,648 to 2,147,483,647 (User-defined position unit)	A	0	step	1862 (0746h)
3726 (0E8Eh)	3727 (0E8Fh)	AREA3 negative direction position/detection range	Sets the negative direction position or distance from the offset position for the AREA3 output. [Setting range] –2,147,483,648 to 2,147,483,647 (User-defined position unit)	A	0	step	1863 (0747h)
3728 (0E90h)	3729 (0E91h)	AREA4 positive direction position/offset	Sets the positive direction position or offset from the target position for the AREA4 output. [Setting range] –2,147,483,648 to 2,147,483,647 (User-defined position unit)	A	0	step	1864 (0748h)
3730 (0E92h)	3731 (0E93h)	AREA4 negative direction position/detection range	Sets the negative direction position or distance from the offset position for the AREA4 output. [Setting range] –2,147,483,648 to 2,147,483,647 (User-defined position unit)	A	0	step	1865 (0749h)
3732 (0E94h)	3733 (0E95h)	AREA5 positive direction position/offset	Sets the positive direction position or offset from the target position for the AREA5 output. [Setting range] –2,147,483,648 to 2,147,483,647 (User-defined position unit)	A	0	step	1866 (074Ah)

Modbus communication register address		Name	Description	Update	Initial setting		NET-ID
Upper	Lower				Initial value	Unit	
3734 (0E96h)	3735 (0E97h)	AREA5 negative direction position/detection range	Sets the negative direction position or distance from the offset position for the AREA5 output. [Setting range] –2,147,483,648 to 2,147,483,647 (User-defined position unit)	A	0	step	1867 (074Bh)
3736 (0E98h)	3737 (0E99h)	AREA6 positive direction position/offset	Sets the positive direction position or offset from the target position for the AREA6 output. [Setting range] –2,147,483,648 to 2,147,483,647 (User-defined position unit)	A	0	step	1868 (074Ch)
3738 (0E9Ah)	3739 (0E9Bh)	AREA6 negative direction position/detection range	Sets the negative direction position or distance from the offset position for the AREA6 output. [Setting range] –2,147,483,648 to 2,147,483,647 (User-defined position unit)	A	0	step	1869 (074Dh)
3740 (0E9Ch)	3741 (0E9Dh)	AREA7 positive direction position/offset	Sets the positive direction position or offset from the target position for the AREA7 output. [Setting range] –2,147,483,648 to 2,147,483,647 (User-defined position unit)	A	0	step	1870 (074Eh)
3742 (0E9Eh)	3743 (0E9Fh)	AREA7 negative direction position/detection range	Sets the negative direction position or distance from the offset position for the AREA7 output. [Setting range] –2,147,483,648 to 2,147,483,647 (User-defined position unit)	A	0	step	1871 (074Fh)
3744 (0EA0h)	3745 (0EA1h)	AREA0 range setting mode	Sets the range setting mode for the AREA0 to AREA7 outputs. [Setting range] 0: Range setting with absolute value 1: Offset/width setting from the target position	A	0	–	1872 (0750h)
3746 (0EA2h)	3747 (0EA3h)	AREA1 range setting mode		A	0	–	1873 (0751h)
3748 (0EA4h)	3749 (0EA5h)	AREA2 range setting mode		A	0	–	1874 (0752h)
3750 (0EA6h)	3751 (0EA7h)	AREA3 range setting mode		A	0	–	1875 (0753h)
3752 (0EA8h)	3753 (0EA9h)	AREA4 range setting mode		A	0	–	1876 (0754h)
3754 (0EAAh)	3755 (0EABh)	AREA5 range setting mode		A	0	–	1877 (0755h)
3756 (0EACH)	3757 (0EADh)	AREA6 range setting mode		A	0	–	1878 (0756h)
3758 (0EAEh)	3759 (0EAFh)	AREA7 range setting mode		A	0	–	1879 (0757h)

Modbus communication register address		Name	Description	Update	Initial setting		NET-ID
Upper	Lower				Initial value	Unit	
3760 (0EB0h)	3761 (0EB1h)	AREA0 positioning standard	Sets the judgment criterion of position for the AREA0 to AREA7 outputs. [Setting range] 0: Based on actual position 1: Based on demand position	A	0	–	1880 (0758h)
3762 (0EB2h)	3763 (0EB3h)	AREA1 positioning standard		A	0	–	1881 (0759h)
3764 (0EB4h)	3765 (0EB5h)	AREA2 positioning standard		A	0	–	1882 (075Ah)
3766 (0EB6h)	3767 (0EB7h)	AREA3 positioning standard		A	0	–	1883 (075Bh)
3768 (0EB8h)	3769 (0EB9h)	AREA4 positioning standard		A	0	–	1884 (075Ch)
3770 (0EBAh)	3771 (0EBBh)	AREA5 positioning standard		A	0	–	1885 (075Dh)
3772 (0EBCh)	3773 (0EBDh)	AREA6 positioning standard		A	0	–	1886 (075Eh)
3774 (0EBEh)	3775 (0EBFh)	AREA7 positioning standard		A	0	–	1887 (075Fh)
3840 (0F00h)	3841 (0F01h)	D-SEL0 operation number selection	Sets the operation data number corresponding to the D-SEL input. [Setting range] 0 to 255: Operation data number	A	0	–	1920 (0780h)
3842 (0F02h)	3843 (0F03h)	D-SEL1 operation number selection		A	1	–	1921 (0781h)
3844 (0F04h)	3845 (0F05h)	D-SEL2 operation number selection		A	2	–	1922 (0782h)
3846 (0F06h)	3847 (0F07h)	D-SEL3 operation number selection		A	3	–	1923 (0783h)
3848 (0F08h)	3849 (0F09h)	D-SEL4 operation number selection		A	4	–	1924 (0784h)
3850 (0F0Ah)	3851 (0F0Bh)	D-SEL5 operation number selection		A	5	–	1925 (0785h)
3852 (0F0Ch)	3853 (0F0Dh)	D-SEL6 operation number selection		A	6	–	1926 (0786h)

Modbus communication register address		Name	Description	Update	Initial setting		NET-ID	
Upper	Lower				Initial value	Unit		
3854 (0F0Eh)	3855 (0F0Fh)	D-SEL7 operation number selection	Sets the operation data number corresponding to the D-SEL input. [Setting range] 0 to 255: Operation data number	A	7	–	1927 (0787h)	
3856 (0F10h)	3857 (0F11h)	D-SEL8 operation number selection		A	8	–	1928 (0788h)	
3858 (0F12h)	3859 (0F13h)	D-SEL9 operation number selection		A	9	–	1929 (0789h)	
3860 (0F14h)	3861 (0F15h)	D-SEL10 operation number selection		A	10	–	1930 (078Ah)	
3862 (0F16h)	3863 (0F17h)	D-SEL11 operation number selection		A	11	–	1931 (078Bh)	
3864 (0F18h)	3865 (0F19h)	D-SEL12 operation number selection		A	12	–	1932 (078Ch)	
3866 (0F1Ah)	3867 (0F1Bh)	D-SEL13 operation number selection		A	13	–	1933 (078Dh)	
3868 (0F1Ch)	3869 (0F1Dh)	D-SEL14 operation number selection		A	14	–	1934 (078Eh)	
3870 (0F1Eh)	3871 (0F1Fh)	D-SEL15 operation number selection		A	15	–	1935 (078Fh)	
3872 (0F20h)	3873 (0F21h)	D-END0 operation number selection		Sets the operation data number corresponding to the D-END output. [Setting range] 0 to 255: Operation data number	A	0	–	1936 (0790h)
3874 (0F22h)	3875 (0F23h)	D-END1 operation number selection			A	1	–	1937 (0791h)
3876 (0F24h)	3877 (0F25h)	D-END2 operation number selection			A	2	–	1938 (0792h)
3878 (0F26h)	3879 (0F27h)	D-END3 operation number selection			A	3	–	1939 (0793h)

Modbus communication register address		Name	Description	Update	Initial setting		NET-ID	
Upper	Lower				Initial value	Unit		
3880 (0F28h)	3881 (0F29h)	D-END4 operation number selection	Sets the operation data number corresponding to the D-END output. [Setting range] 0 to 255: Operation data number	A	4	–	1940 (0794h)	
3882 (0F2Ah)	3883 (0F2Bh)	D-END5 operation number selection		A	5	–	1941 (0795h)	
3884 (0F2Ch)	3885 (0F2Dh)	D-END6 operation number selection		A	6	–	1942 (0796h)	
3886 (0F2Eh)	3887 (0F2Fh)	D-END7 operation number selection		A	7	–	1943 (0797h)	
3888 (0F30h)	3889 (0F31h)	D-END8 operation number selection		A	8	–	1944 (0798h)	
3890 (0F32h)	3891 (0F33h)	D-END9 operation number selection		A	9	–	1945 (0799h)	
3892 (0F34h)	3893 (0F35h)	D-END10 operation number selection		A	10	–	1946 (079Ah)	
3894 (0F36h)	3895 (0F37h)	D-END11 operation number selection		A	11	–	1947 (079Bh)	
3896 (0F38h)	3897 (0F39h)	D-END12 operation number selection		A	12	–	1948 (079Ch)	
3898 (0F3Ah)	3899 (0F3Bh)	D-END13 operation number selection		A	13	–	1949 (079Dh)	
3900 (0F3Ch)	3901 (0F3Dh)	D-END14 operation number selection		A	14	–	1950 (079Eh)	
3902 (0F3Eh)	3903 (0F3Fh)	D-END15 operation number selection		A	15	–	1951 (079Fh)	
5074 (13D2h)	5075 (13D3h)	FW/RV operation control mode setting *		Selects the control mode in FW/RV operation. [Setting range] 0: Normal 1: Motion extension	A	1	–	2537 (09E9h)

* It is effective for the driver version 3.00 or later.

13-8 Direct-IN function selection (DIN)

Modbus communication register address		Name	Description	Update	Initial setting		NET-ID
Upper	Lower				Initial value	Unit	
4224 (1080h)	4225 (1081h)	DIN0 input function	Selects the input signals to be assigned to DIN0 to DIN3. [Setting range] ⇒ "2-1 Input signals list" on p.151	C	72: ID-SEL0	–	2112 (0840h)
4226 (1082h)	4227 (1083h)	DIN1 input function		C	73: ID-SEL1	–	2113 (0841h)
4228 (1084h)	4229 (1085h)	DIN2 input function		C	5: STOP	–	2114 (0842h)
4230 (1086h)	4231 (1087h)	DIN3 input function		C	1: FREE	–	2115 (0843h)
4256 (10A0h)	4257 (10A1h)	DIN0 inverting mode	Changes ON/OFF of DIN0 to DIN3. [Setting range] 0: Not invert 1: Invert	C	0	–	2128 (0850h)
4258 (10A2h)	4259 (10A3h)	DIN1 inverting mode		C	0	–	2129 (0851h)
4260 (10A4h)	4261 (10A5h)	DIN2 inverting mode		C	0	–	2130 (0852h)
4262 (10A6h)	4263 (10A7h)	DIN3 inverting mode		C	0	–	2131 (0853h)
4352 (1100h)	4353 (1101h)	DIN0 composite input function	When any of DIN0 to DIN3 is turned ON, an input signal assigned to the corresponding DIN0 to DIN3 composite input function is simultaneously turned ON. [Setting range] ⇒ "2-1 Input signals list" on p.151	C	0: Not used	–	2176 (0880h)
4354 (1102h)	4355 (1103h)	DIN1 composite input function		C	0: Not used	–	2177 (0881h)
4356 (1104h)	4357 (1105h)	DIN2 composite input function		C	0: Not used	–	2178 (0882h)
4358 (1106h)	4359 (1107h)	DIN3 composite input function		C	0: Not used	–	2179 (0883h)
4480 (1180h)	4481 (1181h)	DIN0 ON signal dead-time	The input signal is turned ON when the time having set is exceeded. This can be used for taking measures to eliminate noise or for adjusting the timing between devices. [Setting range] 0 to 250 ms	C	0	ms	2240 (08C0h)
4482 (1182h)	4483 (1183h)	DIN1 ON signal dead-time		C	0	ms	2241 (08C1h)
4484 (1184h)	4485 (1185h)	DIN2 ON signal dead-time		C	0	ms	2242 (08C2h)
4486 (1186h)	4487 (1187h)	DIN3 ON signal dead-time		C	0	ms	2243 (08C3h)
4512 (11A0h)	4513 (11A1h)	DIN0 1 shot signal	Automatically turns the signal, which was input to DIN0 to DIN3, to OFF (or ON) 250 μs after input. [Setting range] 0: Disable 1: Enable	C	0	–	2256 (08D0h)
4514 (11A2h)	4515 (11A3h)	DIN1 1 shot signal		C	0	–	2257 (08D1h)
4516 (11A4h)	4517 (11A5h)	DIN2 1 shot signal		C	0	–	2258 (08D2h)
4518 (11A6h)	4519 (11A7h)	DIN3 1 shot signal		C	0	–	2259 (08D3h)

13-9 Direct-OUT function selection (DOUT)

Modbus communication register address		Name	Description	Update	Initial setting		NET-ID
Upper	Lower				Initial value	Unit	
4288 (10C0h)	4289 (10C1h)	DOUT0 (normal) Output function	Selects the output signals to be assigned to DOUT0 and DOUT1.	C	241: COMM-PWR	–	2144 (0860h)
4290 (10C2h)	4291 (10C3h)	DOUT1 (normal) Output function	[Setting range] ⇒ "2-2 Output signals list" on p.154	C	130: ALM-B	–	2145 (0861h)
4320 (10E0h)	4321 (10E1h)	DOUT0 inverting mode	Changes ON/OFF of DOUT0 and DOUT1.	C	0	–	2160 (0870h)
4322 (10E2h)	4323 (10E3h)	DOUT1 inverting mode	[Setting range] 0: Not invert 1: Invert	C	0	–	2161 (0871h)
4384 (1120h)	4385 (1121h)	DOUT0 composite output function	Selects the output signals for logical operation with the signals of DOUT0 and DOUT1. When logical combination of the two signals has been established, the output is turned ON.	C	128: CONST-OFF	–	2192 (0890h)
4386 (1122h)	4387 (1123h)	DOUT1 composite output function	[Setting range] ⇒ "2-2 Output signals list" on p.154	C	128: CONST-OFF	–	2193 (0891h)
4416 (1140h)	4417 (1141h)	DOUT0 composite inverting mode	Changes ON/OFF of the composite output function.	C	0	–	2208 (08A0h)
4418 (1142h)	4419 (1143h)	DOUT1 composite inverting mode	[Setting range] 0: Not invert 1: Invert	C	0	–	2209 (08A1h)
4448 (1160h)	4449 (1161h)	DOUT0 composite logical combination	Sets the logical combination [logical conjunction or logical disjunction] of the composite output function.	C	1	–	2224 (08B0h)
4450 (1162h)	4451 (1163h)	DOUT1 composite logical combination	[Setting range] 0: AND 1 OR	C	1	–	2225 (08B1h)
4544 (11C0h)	4545 (11C1h)	DOUT0 OFF delay time	The output signal is turned OFF when the time having set is exceeded. This can be used for taking measures to eliminate noise or for adjusting the timing between devices.	C	0	ms	2272 (08E0h)
4546 (11C2h)	4547 (11C3h)	DOUT1 OFF delay time	[Setting range] 0 to 4,000 ms	C	0	ms	2273 (08E1h)

13-10 Remote-I/O function selection (R-I/O)

Modbus communication register address		Name	Description	Update	Initial setting		NET-ID
Upper	Lower				Initial value	Unit	
34816 (8800h)	34817 (8801h)	R-IN0 input function	Selects the input signals to be assigned to R-IN0 to R-IN31. [Setting range] ⇨ "2-1 Input signals list" on p.151	C	2: S-ON	–	17408 (4400h)
34818 (8802h)	34819 (8803h)	R-IN1 input function		C	24: PLOOP-MODE	–	17409 (4401h)
34820 (8804h)	34821 (8805h)	R-IN2 input function		C	18: TRQ-LMT	–	17410 (4402h)
34822 (8806h)	34823 (8807h)	R-IN3 input function		C	3: CLR	–	17411 (4403h)
34824 (8808h)	34825 (8809h)	R-IN4 input function		C	4: QSTOP	–	17412 (4404h)
34826 (880Ah)	34827 (880Bh)	R-IN5 input function		C	5: STOP	–	17413 (4405h)
34828 (880Ch)	34829 (880Dh)	R-IN6 input function		C	1: FREE	–	17414 (4406h)
34830 (880Eh)	34831 (880Fh)	R-IN7 input function		C	8: ALM-RST	–	17415 (4407h)
34832 (8810h)	34833 (8811h)	R-IN8 input function		C	80: D-SEL0	–	17416 (4408h)
34834 (8812h)	34835 (8813h)	R-IN9 input function		C	81: D-SEL1	–	17417 (4409h)
34836 (8814h)	34837 (8815h)	R-IN10 input function		C	82: D-SEL2	–	17418 (440Ah)
34838 (8816h)	34839 (8817h)	R-IN11 input function		C	83: D-SEL3	–	17419 (440Bh)
34840 (8818h)	34841 (8819h)	R-IN12 input function		C	84: D-SEL4	–	17420 (440Ch)
34842 (881Ah)	34843 (881Bh)	R-IN13 input function		C	85: D-SEL5	–	17421 (440Dh)
34844 (881Ch)	34845 (881Dh)	R-IN14 input function		C	86: D-SEL6	–	17422 (440Eh)
34846 (881Eh)	34847 (881Fh)	R-IN15 input function		C	87: D-SEL7	–	17423 (440Fh)
34848 (8820h)	34849 (8821h)	R-IN16 input function		C	52: FW-JOG-P	–	17424 (4410h)
34850 (8822h)	34851 (8823h)	R-IN17 input function		C	53: RV-JOG-P	–	17425 (4411h)
34852 (8824h)	34853 (8825h)	R-IN18 input function		C	58: FW-SPD	–	17426 (4412h)
34854 (8826h)	34855 (8827h)	R-IN19 input function		C	59: RV-SPD	–	17427 (4413h)
34856 (8828h)	34857 (8829h)	R-IN20 input function		C	36: HOME	–	17428 (4414h)
34858 (882Ah)	34859 (882Bh)	R-IN21 input function		C	0: Not used	–	17429 (4415h)
34860 (882Ch)	34861 (882Dh)	R-IN22 input function		C	32: START	–	17430 (4416h)
34862 (882Eh)	34863 (882Fh)	R-IN23 input function		C	33: SSTART	–	17431 (4417h)
34864 (8830h)	34865 (8831h)	R-IN24 input function	C	40: M0	–	17432 (4418h)	

Modbus communication register address		Name	Description	Update	Initial setting		NET-ID
Upper	Lower				Initial value	Unit	
34866 (8832h)	34867 (8833h)	R-IN25 input function	Selects the input signals to be assigned to R-IN0 to R-IN31. [Setting range] ⇒ "2-1 Input signals list" on p.151	C	41: M1	–	17433 (4419h)
34868 (8834h)	34869 (8835h)	R-IN26 input function		C	42: M2	–	17434 (441Ah)
34870 (8836h)	34871 (8837h)	R-IN27 input function		C	43: M3	–	17435 (441Bh)
34872 (8838h)	34873 (8839h)	R-IN28 input function		C	44: M4	–	17436 (441Ch)
34874 (883Ah)	34875 (883Bh)	R-IN29 input function		C	45: M5	–	17437 (441Dh)
34876 (883Ch)	34877 (883Dh)	R-IN30 input function		C	46: M6	–	17438 (441Eh)
34878 (883Eh)	34879 (883Fh)	R-IN31 input function		C	47: M7	–	17439 (441Fh)
34880 (8840h)	34881 (8841h)	R-OUT0 output function	Selects the output signals to be assigned to R-OUT0 to R-OUT31. [Setting range] ⇒ "2-2 Output signals list" on p.154	C	133: SON-MON	–	17440 (4420h)
34882 (8842h)	34883 (8843h)	R-OUT1 output function		C	192: PLOOP-MON	–	17441 (4421h)
34884 (8844h)	34885 (8845h)	R-OUT2 output function		C	224: TRQ-LMTD	–	17442 (4422h)
34886 (8846h)	34887 (8847h)	R-OUT3 output function		C	148: RDY-DD-OPE	–	17443 (4423h)
34888 (8848h)	34889 (8849h)	R-OUT4 output function		C	177: ABSPEN	–	17444 (4424h)
34890 (884Ah)	34891 (884Bh)	R-OUT5 output function		C	5: STOP_R	–	17445 (4425h)
34892 (884Ch)	34893 (884Dh)	R-OUT6 output function		C	1: FREE_R	–	17446 (4426h)
34894 (884Eh)	34895 (884Fh)	R-OUT7 output function		C	129: ALM-A	–	17447 (4427h)
34896 (8850h)	34897 (8851h)	R-OUT8 output function		C	136: SYS-BSY	–	17448 (4428h)
34898 (8852h)	34899 (8853h)	R-OUT9 output function		C	138: IN-POS	–	17449 (4429h)
34900 (8854h)	34901 (8855h)	R-OUT10 output function		C	145: RDY-HOME-OPE	–	17450 (442Ah)
34902 (8856h)	34903 (8857h)	R-OUT11 output function		C	146: RDY-FWRV-OPE	–	17451 (442Bh)
34904 (8858h)	34905 (8859h)	R-OUT12 output function		C	147: RDY-SD-OPE	–	17452 (442Ch)
34906 (885Ah)	34907 (885Bh)	R-OUT13 output function		C	134: MOVE	–	17453 (442Dh)
34908 (885Ch)	34909 (885Dh)	R-OUT14 output function		C	141: VA	–	17454 (442Eh)
34910 (885Eh)	34911 (885Fh)	R-OUT15 output function		C	140: TLC	–	17455 (442Fh)
34912 (8860h)	34913 (8861h)	R-OUT16 output function		C	135: INFO	–	17456 (4430h)
34914 (8862h)	34915 (8863h)	R-OUT17 output function		C	262: INFO-MNT-G	–	17457 (4431h)
34916 (8864h)	34917 (8865h)	R-OUT18 output function	C	264: INFO-DRVTMP	–	17458 (4432h)	

Modbus communication register address		Name	Description	Update	Initial setting		NET-ID
Upper	Lower				Initial value	Unit	
34918 (8866h)	34919 (8867h)	R-OUT19 output function	Selects the output signals to be assigned to R-OUT0 to R-OUT31. [Setting range] ⇒ "2-2 Output signals list" on p.154	C	265: INFO-MTRTMP	–	17459 (4433h)
34920 (8868h)	34921 (8869h)	R-OUT20 output function		C	267: INFO-TRQ	–	17460 (4434h)
34922 (886Ah)	34923 (886Bh)	R-OUT21 output function		C	268: INFO-WATT	–	17461 (4435h)
34924 (886Ch)	34925 (886Dh)	R-OUT22 output function		C	272: INFO-VOLT-H	–	17462 (4436h)
34926 (886Eh)	34927 (886Fh)	R-OUT23 output function		C	273: INFO-VOLT-L	–	17463 (4437h)
34928 (8870h)	34929 (8871h)	R-OUT24 output function		C	257: INFO-START-G	–	17464 (4438h)
34930 (8872h)	34931 (8873h)	R-OUT25 output function		C	256: INFO-USRIO-G	–	17465 (4439h)
34932 (8874h)	34933 (8875h)	R-OUT26 output function		C	128: CONST-OFF	–	17466 (443Ah)
34934 (8876h)	34935 (8877h)	R-OUT27 output function		C	128: CONST-OFF	–	17467 (443Bh)
34936 (8878h)	34937 (8879h)	R-OUT28 output function		C	128: CONST-OFF	–	17468 (443Ch)
34938 (887Ah)	34939 (887Bh)	R-OUT29 output function		C	128: CONST-OFF	–	17469 (443Dh)
34940 (887Ch)	34941 (887Dh)	R-OUT30 output function		C	288: USR-OUT0	–	17470 (443Eh)
34942 (887Eh)	34943 (887Fh)	R-OUT31 output function		C	289: USR-OUT1	–	17471 (443Fh)
35008 (88C0h)	35009 (88C1h)	R-OUT0 OFF delay time		Sets the OFF delay time for R-OUT0 to R-OUT31. [Setting range] 0 to 4,000 ms	C	0	ms
35010 (88C2h)	35011 (88C3h)	R-OUT1 OFF delay time	C		0	ms	17505 (4461h)
35012 (88C4h)	35013 (88C5h)	R-OUT2 OFF delay time	C		0	ms	17506 (4462h)
35014 (88C6h)	35015 (88C7h)	R-OUT3 OFF delay time	C		0	ms	17507 (4463h)
35016 (88C8h)	35017 (88C9h)	R-OUT4 OFF delay time	C		0	ms	17508 (4464h)
35018 (88CAh)	35019 (88CBh)	R-OUT5 OFF delay time	C		0	ms	17509 (4465h)
35020 (88CCh)	35021 (88CDh)	R-OUT6 OFF delay time	C		0	ms	17510 (4466h)
35022 (88CEh)	35023 (88CFh)	R-OUT7 OFF delay time	C		0	ms	17511 (4467h)
35024 (88D0h)	35025 (88D1h)	R-OUT8 OFF delay time	C		0	ms	17512 (4468h)
35026 (88D2h)	35027 (88D3h)	R-OUT9 OFF delay time	C		0	ms	17513 (4469h)
35028 (88D4h)	35029 (88D5h)	R-OUT10 OFF delay time	C		0	ms	17514 (446Ah)
35030 (88D6h)	35031 (88D7h)	R-OUT11 OFF delay time	C		0	ms	17515 (446Bh)
35032 (88D8h)	35033 (88D9h)	R-OUT12 OFF delay time	C		0	ms	17516 (446Ch)

Modbus communication register address		Name	Description	Update	Initial setting		NET-ID
Upper	Lower				Initial value	Unit	
35034 (88DAh)	35035 (88DBh)	R-OUT13 OFF delay time	Sets the OFF delay time for R-OUT0 to R-OUT31. [Setting range] 0 to 4,000 ms	C	0	ms	17517 (446Dh)
35036 (88DCh)	35037 (88DDh)	R-OUT14 OFF delay time		C	0	ms	17518 (446Eh)
35038 (88DEh)	35039 (88DFh)	R-OUT15 OFF delay time		C	0	ms	17519 (446Fh)
35040 (88E0h)	35041 (88E1h)	R-OUT16 OFF delay time		C	0	ms	17520 (4470h)
35042 (88E2h)	35043 (88E3h)	R-OUT17 OFF delay time		C	0	ms	17521 (4471h)
35044 (88E4h)	35045 (88E5h)	R-OUT18 OFF delay time		C	0	ms	17522 (4472h)
35046 (88E6h)	35047 (88E7h)	R-OUT19 OFF delay time		C	0	ms	17523 (4473h)
35048 (88E8h)	35049 (88E9h)	R-OUT20 OFF delay time		C	0	ms	17524 (4474h)
35050 (88EAh)	35051 (88EBh)	R-OUT21 OFF delay time		C	0	ms	17525 (4475h)
35052 (88ECh)	35053 (88EDh)	R-OUT22 OFF delay time		C	0	ms	17526 (4476h)
35054 (88EEh)	35055 (88EFh)	R-OUT23 OFF delay time		C	0	ms	17527 (4477h)
35056 (88F0h)	35057 (88F1h)	R-OUT24 OFF delay time		C	0	ms	17528 (4478h)
35058 (88F2h)	35059 (88F3h)	R-OUT25 OFF delay time		C	0	ms	17529 (4479h)
35060 (88F4h)	35061 (88F5h)	R-OUT26 OFF delay time		C	0	ms	17530 (447Ah)
35062 (88F6h)	35063 (88F7h)	R-OUT27 OFF delay time		C	0	ms	17531 (447Bh)
35064 (88F8h)	35065 (88F9h)	R-OUT28 OFF delay time		C	0	ms	17532 (447Ch)
35066 (88FAh)	35067 (88FBh)	R-OUT29 OFF delay time		C	0	ms	17533 (447Dh)
35068 (88FCh)	35069 (88FDh)	R-OUT30 OFF delay time		C	0	ms	17534 (447Eh)
35070 (88FEh)	35071 (88FFh)	R-OUT31 OFF delay time		C	0	ms	17535 (447Fh)

13-11 Adjustment and function

Modbus communication register address		Name	Description	Update	Initial setting		NET-ID
Upper	Lower				Initial value	Unit	
576 (0240h)	577 (0241h)	Load inertia setting mode selection	Selects the setting method of the load inertia. [Setting Range] –2: Automatic –1: "Load inertia setting" parameter is used 0: Small inertia (2 times) 1: Medium inertia (7.5 times) 2: Large inertia (20 times)	A	0	–	288 (0120h)
578 (0242h)	579 (0243h)	Load inertia setting	Sets the ratio of the load inertia to the motor rotor inertia. When the rotor inertia is equal to the load inertia, the ratio is 100%. [Setting range] 0 to 10,000%	A	0	–	289 (0121h)
584 (0248h)	585 (0249h)	Mechanical rigidity setting	Selects the rigidity of equipment. The motor response improves as the setting value increases. An excessively high value may cause the motor to vibrate or to generate noise. [Setting range] 0 to 15	A	4	–	292 (0124h)
594 (0252h)	595 (0253h)	Command filter setting	Selects the command filter to be activated for the operation command. [Setting range] 1: LPF (speed filter) 2: Moving average filter	B	1	–	297 (0129h)
596 (0254h)	597 (0255h)	Command filter time constant	Sets the time constant for the command filter to adjust the motor response. [Setting range] 0 to 200 ms	B	1	ms	298 (012Ah)
604 (025Ch)	605 (025Dh)	Motor response setting	Selects the setting method of the motor response in reaction to the command. [Setting Range] –1: Manual setting 0 to 8	A	4	–	302 (012Eh)
606 (025Eh)	607 (025Fh)	Position loop gain	Adjusts the motor response in reaction to the position deviation. Increasing the value will make the deviation between the demand position and the actual position smaller. An excessively large value may increase the motor overshoot or cause the motor vibration. [Setting range] 1 to 50 Hz	A	6	–	303 (012Fh)

Modbus communication register address		Name	Description	Update	Initial setting		NET-ID
Upper	Lower				Initial value	Unit	
608 (0260h)	609 (0261h)	Speed loop gain	Adjusts the motor response in reaction to the speed deviation. Increasing the value will make the deviation between the demand velocity and the actual velocity smaller. An excessively large value may increase the motor overshoot or cause the motor vibration. [Setting range] 1 to 500 Hz	A	56	–	304 (0130h)
610 (0262h)	611 (0263h)	Speed loop integral time constant	Decreases the deviation that cannot be adjusted with the speed loop gain. An excessively long value may slow the motor response. Too short value may cause the motor vibration. [Setting range] 1 to 10,000 (1=0.01 ms)	A	2,840	1=0.01 ms	305 (0131h)
620 (026Ch)	621 (026Dh)	Electronic damper	Sets the electronic damper function for vibration suppression set in the motor in advance. [Setting range] 0: Disable 1: Enable	A	1	–	310 (0136h)
628 (0274h)	629 (0275h)	Torque filter (LPF)	Changes the motor response at high frequencies. [Setting range] 0 to 4700 Hz	A	560	Hz	314 (013Ah)
630 (0276h)	631 (0277h)	Speed feed-forward	When the velocity is constant, the deviation between the demand position and the actual position can be reduced to shorten the settling time. If it is set to 100%, the deviation will be approximately 0%. However, an excessively high value may increase the motor overshoot or cause the motor vibration. [Setting range] 0 to 100%	A	80	%	315 (013Bh)
954 (03BAh)	955 (03BBh)	Electromagnetic brake automatic control	Sets the control method of the electromagnetic brake. When controlling the electromagnetic brake using the host controller, set to "0: Disable." [Setting range] 0: Disable 1: Automatic control 2: Automatic control with alarm detection	D	2	–	477 (01DDh)
4128 (1020h)	4129 (1021h)	Damping control frequency	Sets the frequency of vibration to be suppressed. [Setting range] 700 to 20000 (1=0.01 Hz)	A	10,000	1=0.01 Hz	2064 (0810h)
4130 (1022h)	4131 (1023h)	Damping control gain	Sets the gain for damping control (vibration suppression control). [Setting range] 0 to 100%	A	0	%	2065 (0811h)

Modbus communication register address		Name	Description	Update	Initial setting		NET-ID
Upper	Lower				Initial value	Unit	
4134 (1026h)	4135 (1027h)	Resonance suppression control A frequency	Sets the frequency of vibration to be suppressed. [Setting range] 100 to 3,200 Hz	A	1,000	Hz	2067 (0813h)
4136 (1028h)	4137 (1029h)	Resonance suppression control A gain	Sets the gain to suppress the vibration. Increasing the value causes the motor response to the deviation to lower. [Setting range] 0 to 100%	A	0	%	2068 (0814h)
4138 (102Ah)	4139 (102Bh)	Resonance suppression control A width	Sets the width of vibration to be suppressed. [Setting range] 30 to 120	A	30	–	2069 (0815h)
4140 (102Ch)	4141 (102Dh)	Resonance suppression control B frequency	Sets the frequency of vibration to be suppressed. [Setting range] 100 to 3,200 Hz	A	1,000	Hz	2070 (0816h)
4142 (102Eh)	4143 (102Fh)	Resonance suppression control B gain	Sets the gain to suppress the vibration. Increasing the value causes the motor response to the deviation to lower. [Setting range] 0 to 100%	A	0	%	2071 (0817h)
4144 (1030h)	4145 (1031h)	Resonance suppression control B width	Sets the width of vibration to be suppressed. [Setting range] 30 to 120	A	30	–	2072 (0818h)
4146 (1032h)	4147 (1033h)	Resonance suppression control C frequency	Sets the frequency of vibration to be suppressed. [Setting range] 100 to 3,200 Hz	A	1,000	Hz	2073 (0819h)
4148 (1034h)	4149 (1035h)	Resonance suppression control C gain	Sets the gain to suppress the vibration. Increasing the value causes the motor response to the deviation to lower. [Setting range] 0 to 100%	A	0	%	2074 (081Ah)
4150 (1036h)	4151 (1037h)	Resonance suppression control C width	Sets the width of vibration to be suppressed. [Setting range] 30 to 120	A	30	–	2075 (081Bh)
4152 (1038h)	4153 (1039h)	Resonance suppression control D frequency	Sets the frequency of vibration to be suppressed. [Setting range] 100 to 3,200 Hz	A	1,000	Hz	2076 (081Ch)
4154 (103Ah)	4155 (103Bh)	Resonance suppression control D gain	Sets the gain to suppress the vibration. Increasing the value causes the motor response to the deviation to lower. [Setting range] 0 to 100%	A	0	%	2077 (081Dh)
4156 (103Ch)	4157 (103Dh)	Resonance suppression control D width	Sets the width of vibration to be suppressed. [Setting range] 30 to 120	A	30	–	2078 (081Eh)

Modbus communication register address		Name	Description	Update	Initial setting		NET-ID
Upper	Lower				Initial value	Unit	
5060 (13C4h)	5061 (13C5h)	FFT target	Selects the target of FFT. [Setting range] 0: Torque 1: Velocity	A	0	–	2530 (09E2h)
5062 (13C6h)	5063 (13C7h)	Velocity detection monitor time constant	Sets the time constant of the velocity monitor. [Setting range] 1 to 100 ms	A	5	ms	2531 (09E3h)

13-12 Information setting

Modbus communication register address		Name	Description	Update	Initial setting		NET-ID
Upper	Lower				Initial value	Unit	
36352 (8E00h)	36353 (8E01h)	INFO action (assigned I/O status group information (INFO-USRIO-G))	Sets whether or not to apply to the group output, INFO output, and LED blinking when information is generated. [Setting range] 0: INFO action is not applied * 1: INFO action is applied * The information history is left.	A	1	–	18176 (4700h)
36354 (8E02h)	36355 (8E03h)	INFO action (start operation group information (INFO-START-G))		A	1	–	18177 (4701h)
36356 (8E04h)	36357 (8E05h)	INFO action (RS-485 communication group information (INFO-485-G))		A	1	–	18178 (4702h)
36364 (8E0Ch)	36365 (8E0Dh)	INFO action (maintenance group information (INFO-MNT-G))		A	1	–	18182 (4706h)
36366 (8E0Eh)	36367 (8E0Fh)	INFO action (setting group information (INFO-SET-G))		A	1	–	18183 (4707h)
36368 (8E10h)	36369 (8E11h)	INFO action (driver temperature information (INFO-DRVTMP))		A	1	–	18184 (4708h)
36370 (8E12h)	36371 (8E13h)	INFO action (motor temperature information (INFO-MTRTMP))		A	1	–	18185 (4709h)
36372 (8E14h)	36373 (8E15h)	INFO action (load factor information (INFO-LOAD))		A	1	–	18186 (470Ah)
36374 (8E16h)	36375 (8E17h)	INFO action (torque information (INFO-TRQ))		A	1	–	18187 (470Bh)
36376 (8E18h)	36377 (8E19h)	INFO action (power consumption information (INFO-WATT))		A	1	–	18188 (470Ch)
36384 (8E20h)	36385 (8E21h)	INFO action (upper voltage information (INFO-VOLT-H))		A	1	–	18192 (4710h)
36386 (8E22h)	36387 (8E23h)	INFO action (lower voltage information (INFO-VOLT-L))		A	1	–	18193 (4711h)

6 Address codes list

Modbus communication register address		Name	Description	Update	Initial setting		NET-ID
Upper	Lower				Initial value	Unit	
36406 (8E36h)	36407 (8E37h)	INFO action (preset execution information (INFO-PRESET))	Sets whether or not to apply to the group output, INFO output, and LED blinking when information is generated. [Setting range] 0: INFO action is not applied * 1: INFO action is applied * The information history is left.	A	1	—	18203 (471Bh)
36408 (8E38h)	36409 (8E39h)	INFO action (Operation start restricted mode information (INFO-DSLMTD))		A	1	—	18204 (471Ch)
36410 (8E3Ah)	36411 (8E3Bh)	INFO action (I/O test mode information (INFO-IOTEST))		A	1	—	18205 (471Dh)
36412 (8E3Ch)	36413 (8E3Dh)	INFO action (configuration request information (INFO-CONFIG))		A	1	—	18206 (471Eh)
36414 (8E3Eh)	36415 (8E3Fh)	INFO action (reboot request information (INFO-REBOOT))		A	1	—	18207 (471Fh)
36416 (8E40h)	36417 (8E41h)	INFO action (assigned I/O status 0 information (INFO-USRIO0))		A	1	—	18208 (4720h)
36418 (8E42h)	36419 (8E43h)	INFO action (assigned I/O status 1 information (INFO-USRIO1))		A	1	—	18209 (4721h)
36420 (8E44h)	36421 (8E45h)	INFO action (assigned I/O status 2 information (INFO-USRIO2))		A	1	—	18210 (4722h)
36422 (8E46h)	36423 (8E47h)	INFO action (assigned I/O status 3 information (INFO-USRIO3))		A	1	—	18211 (4723h)
36424 (8E48h)	36425 (8E49h)	INFO action (assigned I/O status 4 information (INFO-USRIO4))		A	1	—	18212 (4724h)
36426 (8E4Ah)	36427 (8E4Bh)	INFO action (assigned I/O status 5 information (INFO-USRIO5))		A	1	—	18213 (4725h)
36428 (8E4Ch)	36429 (8E4Dh)	INFO action (assigned I/O status 6 information (INFO-USRIO6))		A	1	—	18214 (4726h)
36430 (8E4Eh)	36431 (8E4Fh)	INFO action (assigned I/O status 7 information (INFO-USRIO7))		A	1	—	18215 (4727h)
36432 (8E50h)	36433 (8E51h)	INFO action (position deviation information (INFO-POS-ERR))		A	1	—	18216 (4728h)
36440 (8E58h)	36441 (8E59h)	INFO action (upper speed information (INFO-SPD-H))		A	1	—	18220 (472Ch)
36442 (8E5Ah)	36443 (8E5Bh)	INFO action (lower speed information (INFO-SPD-L))		A	1	—	18221 (472Dh)
36444 (8E5Ch)	36445 (8E5Dh)	INFO action (speed deviation information (INFO-SPD-ERR))	A	1	—	18222 (472Eh)	
36448 (8E60h)	36449 (8E61h)	INFO action (torque limiting time information (INFO-TLC-TIME))	A	1	—	18224 (4730h)	

Modbus communication register address		Name	Description	Update	Initial setting		NET-ID
Upper	Lower				Initial value	Unit	
36452 (8E64h)	36453 (8E65h)	INFO action (cumulative load 0 information (INFO-CULD0))	Sets whether or not to apply to the group output, INFO output, and LED blinking when information is generated. [Setting range] 0: INFO action is not applied * 1: INFO action is applied * The information history is left.	A	1	–	18226 (4732h)
36454 (8E66h)	36455 (8E67h)	INFO action (cumulative load 1 information (INFO-CULD1))		A	1	–	18227 (4733h)
36462 (8E6Eh)	36463 (8E6Fh)	INFO action (settling time information (INFO-STLTIME))		A	1	–	18231 (4737h)
36480 (8E80h)	36481 (8E81h)	INFO action (energy consumption information (INFO-WH-BOOT))		A	1	–	18240 (4740h)
36482 (8E82h)	36483 (8E83h)	INFO action (user energy consumption information (INFO-WH-USR))		A	1	–	18241 (4741h)
36484 (8E84h)	36485 (8E85h)	INFO action (total energy consumption information (INFO-WH-TOTAL))		A	1	–	18242 (4742h)
36492 (8E8Ch)	36493 (8E8Dh)	INFO action (positive direction main power supply current information (INFO-MP-FWCRNT))		A	1	–	18246 (4746h)
36494 (8E8Eh)	36495 (8E8Fh)	INFO action (negative direction main power supply current information (INFO-MP-RVCRNT))		A	1	–	18247 (4747h)
36496 (8E90h)	36497 (8E91h)	INFO action (tripmeter 0 information (INFO-TRIP0))		A	1	–	18248 (4748h)
36498 (8E92h)	36499 (8E93h)	INFO action (tripmeter 1 information (INFO-TRIP1))		A	1	–	18249 (4749h)
36500 (8E94h)	36501 (8E95h)	INFO action (odometer information (INFO-ODO))		A	1	–	18250 (474Ah)
36504 (8E98h)	36505 (8E99h)	INFO action (CPU load information (INFO-CPU-LOAD))		A	1	–	18252 (474Ch)
36506 (8E9Ah)	36507 (8E9Bh)	INFO action (total uptime information (INFO-PTIME))		A	1	–	18253 (474Dh)
36508 (8E9Ch)	36509 (8E9Dh)	INFO action (number of boots information (INFO-PCOUNT))		A	1	–	18254 (474Eh)
36512 (8EA0h)	36513 (8EA1h)	INFO action (RS-485 communication error information (INFO-485-ERR))		A	1	–	18256 (4750h)
36514 (8EA2h)	36515 (8EA3h)	INFO action (RS-485 communication processing time information (INFO-485-PRCST))		A	1	–	18257 (4751h)

Modbus communication register address		Name	Description	Update	Initial setting		NET-ID
Upper	Lower				Initial value	Unit	
36516 (8EA4h)	36517 (8EA5h)	INFO action (RS-485 communication interval information (INFO-485-INTVL))	Sets whether or not to apply to the group output, INFO output, and LED blinking when information is generated. [Setting range] 0: INFO action is not applied * 1: INFO action is applied * The information history is left.	A	1	–	18258 (4752h)
36528 (8EB0h)	36529 (8EB1h)	INFO action (CAN communication warning information (INFO-485-INTVL))		A	1	–	18264 (4758h)
36546 (8EC2h)	36547 (8EC3h)	INFO action (start homing error information (INFO-START-HOME))		A	1	–	18273 (4761h)
36548 (8EC4h)	36549 (8EC5h)	INFO action (start FW/RV operation error information (INFO-START-FWRV))		A	1	–	18274 (4762h)
36550 (8EC6h)	36551 (8EC7h)	INFO action (start stored data operation error information (INFO-START-SD))		A	1	–	18275 (4763h)
36552 (8EC8h)	36553 (8EC9h)	INFO action (start direct data operation error information (INFO-START-DD))		A	1	–	18276 (4764h)
36554 (8ECAh)	36555 (8ECBh)	INFO action (start drive profile error information (INFO-START-DP))		A	1	–	18277 (4765h)
36558 (8ECEh)	36559 (8ECFh)	INFO action (driving prohibited information (INFO-IDDRV-DIS))		A	1	–	18279 (4767h)
36560 (8ED0h)	36561 (8ED1h)	INFO action (forward operation prohibition information (INFO-FW-OT))		A	1	–	18280 (4768h)
36562 (8ED2h)	36563 (8ED3h)	INFO action (reverse operation prohibition information (INFO-RV-OT))		A	1	–	18281 (4769h)
36576 (8EE0h)	36577 (8EE1h)	INFO action (unit setting information (INFO-UNIT-E))		A	1	–	18288 (4770h)
36578 (8EE2h)	36579 (8EE3h)	INFO action (software limit setting information (INFO-SOFTLMT-E))		A	1	–	18289 (4771h)
36592 (8EF0h)	36593 (8EF1h)	INFO action (CPU fault information (INFO-CPU-FAULT))		A	1	–	18296 (4778h)
36594 (8EF2h)	36595 (8EF3h)	INFO action (over current fault information (INFO-CPU-FAULT))		A	1	–	18297 (4779h)
36596 (8EF4h)	36597 (8EF5h)	INFO action (encoder fault information (INFO-CPU-FAULT))		A	1	–	18298 (477Ah)

Modbus communication register address		Name	Description	Update	Initial setting		NET-ID
Upper	Lower				Initial value	Unit	
36616 (8F08h)	36617 (8F09h)	Information LED condition	Sets the LED status when information is generated. [Setting range] 0: Disable 1: Enable	A	1	–	18308 (4784h)
36618 (8F0Ah)	36619 (8F0Bh)	Information auto clear	When the condition to clear the information is satisfied, a bit output of the corresponding information is automatically turned OFF. [Setting range] 0: Disable 1: Enable	A	1	–	18309 (4785h)
36624 (8F10h)	36625 (8F11h)	INFO-USRIO0 output selection	Selects the output signals to be checked with the INFO-USRIO0 to INFO-USRIO7 outputs. [Setting range] ⇒ "2-2 Output signals list" on p.154	A	128: CONST-OFF	–	18312 (4788h)
36626 (8F12h)	36627 (8F13h)	INFO-USRIO1 output selection		A	128: CONST-OFF	–	18313 (4789h)
36628 (8F14h)	36629 (8F15h)	INFO-USRIO2 output selection		A	128: CONST-OFF	–	18314 (478Ah)
36630 (8F16h)	36631 (8F17h)	INFO-USRIO3 output selection		A	128: CONST-OFF	–	18315 (478Bh)
36632 (8F18h)	36633 (8F19h)	INFO-USRIO4 output selection		A	128: CONST-OFF	–	18316 (478Ch)
36634 (8F1Ah)	36635 (8F1Bh)	INFO-USRIO5 output selection		A	128: CONST-OFF	–	18317 (478Dh)
36636 (8F1Ch)	36637 (8F1Dh)	INFO-USRIO6 output selection		A	128: CONST-OFF	–	18318 (478Eh)
36638 (8F1Eh)	36639 (8F1Fh)	INFO-USRIO7 output selection		A	128: CONST-OFF	–	18319 (478Fh)
36640 (8F20h)	36641 (8F21h)	INFO-USRIO0 output inversion		Sets the ON/OFF inversion function to output signals to be checked with the INFO-USRIO0 to INFO-USRIO7 outputs. [Setting range] 0: Not invert 1: Invert	A	0	–
36642 (8F22h)	36643 (8F23h)	INFO-USRIO1 output inversion	A		0	–	18321 (4791h)
36644 (8F24h)	36645 (8F25h)	INFO-USRIO2 output inversion	A		0	–	18322 (4792h)
36646 (8F26h)	36647 (8F27h)	INFO-USRIO3 output inversion	A		0	–	18323 (4793h)
36648 (8F28h)	36649 (8F29h)	INFO-USRIO4 output inversion	A		0	–	18324 (4794h)
36650 (8F2Ah)	36651 (8F2Bh)	INFO-USRIO5 output inversion	A		0	–	18325 (4795h)
36652 (8F2Ch)	36653 (8F2Dh)	INFO-USRIO6 output inversion	A		0	–	18326 (4796h)
36654 (8F2Eh)	36655 (8F2Fh)	INFO-USRIO7 output inversion	A		0	–	18327 (4797h)

Modbus communication register address		Name	Description	Update	Initial setting		NET-ID
Upper	Lower				Initial value	Unit	
36656 (8F30h)	36657 (8F31h)	Driver temperature information (INFO-DRVTMP)	Sets the condition in which the driver temperature information is generated. [Setting range] 0: Disable 1 to 120 °C	A	0	°C	18328 (4798h)
36658 (8F32h)	36659 (8F33h)	Motor temperature information (INFO-MTRTMP)	Sets the condition in which the motor temperature information is generated. [Setting range] 0: Disable 1 to 120 °C	A	0	°C	18329 (4799h)
36660 (8F34h)	36661 (8F35h)	Position deviation information (INFO-POS-ERR)	Sets the condition in which the position deviation information is generated. [Setting range] 0: Disable 1 to 10,000,000 (User-defined position unit)	A	0	step	18330 (479Ah)
36674 (8F42h)	36675 (8F43h)	Upper speed information (INFO-SPD-H)	Sets the condition in which the upper speed information is generated. [Setting range] 0: Disable 1 to 4,000,000 (User-defined velocity unit)	A	0	r/min	18337 (47A1h)
36676 (8F44h)	36677 (8F45h)	Lower speed information (INFO-SPD-L)	Sets the condition in which the lower speed information is generated. [Setting range] 0: Disable 1 to 4,000,000 (User-defined velocity unit)	A	0	r/min	18338 (47A2h)
36678 (8F46h)	36679 (8F47h)	Speed deviation information (INFO-SPD-ERR)	Sets the condition in which the speed deviation information is generated. [Setting range] 0: Disable 1 to 4,000,000 (User-defined velocity unit)	A	0	r/min	18339 (47A3h)
36686 (8F4Eh)	36687 (8F4Fh)	Load factor information (INFO-LOAD)	Sets the condition in which the load factor information is generated. [Setting range] 0: Disable 1 to 10,000 (1=0.1%)	A	0	1=0.1%	18343 (47A7h)
36688 (8F50h)	36689 (8F51h)	Torque information (INFO-TRQ)	Sets the condition in which the torque information is generated. [Setting range] 0: Disable 1 to 10,000 (1=0.1%)	A	0	1=0.1%	18344 (47A8h)

Modbus communication register address		Name	Description	Update	Initial setting		NET-ID
Upper	Lower				Initial value	Unit	
36692 (8F54h)	36693 (8F55h)	Torque limiting time information (INFO-TLC-TIME)	Sets the condition in which the torque limiting time information is generated. [Setting range] 0: Disable 1 to 10,000 ms	A	0	ms	18346 (47AAh)
36694 (8F56h)	36695 (8F57h)	Settling time information (INFO-STLTIME)	Sets the condition in which the settling time information is generated. [Setting range] 0: Disable 1 to 10,000 ms	A	0	ms	18347 (47ABh)
36708 (8F64h)	36709 (8F65h)	Upper voltage information (INFO-VOLT-H)	Sets the condition in which the upper voltage information is generated. [Setting range] 0: Disable 1 to 1,000 (1=0.1 V)	A	0	1=0.1 V	18354 (47B2h)
36710 (8F66h)	36711 (8F67h)	Lower voltage information (INFO-VOLT-L)	Sets the condition in which the lower voltage information is generated. [Setting range] 0: Disable 1 to 1,000 (1=0.1 V)	A	0	1=0.1 V	18355 (47B3h)
36712 (8F68h)	36713 (8F69h)	Positive direction main power supply current information (INFO-MP-FWCRNT)	Sets the condition in which the positive direction main power supply current information is generated. [Setting range] 0: Disable 1 to 500 (1=0.1 A)	A	0	1=0.1 A	18356 (47B4h)
36714 (8F6Ah)	36715 (8F6Bh)	Negative direction main power supply current information (INFO-MP-RVCRNT)	Sets the condition in which the negative direction main power supply current information is generated. [Setting range] 0: Disable -500 to -1 (1=0.1 A)	A	0	1=0.1 A	18357 (47B5h)
36720 (8F70h)	36721 (8F71h)	Power consumption information (INFO-WATT)	Sets the condition in which the power consumption information is generated. [Setting range] 0: Disable 1 to 10,000 (1=0.1 W)	A	0	1=0.1 W	18360 (47B8h)
36722 (8F72h)	36723 (8F73h)	Energy consumption information (INFO-WH-BOOT)	Sets the condition in which the energy consumption information is generated. [Setting range] 0: Disable 1 to 2,147,483,647 (1=0.001 Wh)	A	0	1=0.001 Wh	18361 (47B9h)

Modbus communication register address		Name	Description	Update	Initial setting		NET-ID
Upper	Lower				Initial value	Unit	
36724 (8F74h)	36725 (8F75h)	User energy consumption information (INFO-WH-USR)	Sets the condition in which the user energy consumption information is generated. [Setting range] 0: Disable 1 to 2,147,483,647 (Wh)	A	0	Wh	18362 (47BAh)
36726 (8F76h)	36727 (8F77h)	Total energy consumption information (INFO-WH-TOTAL)	Sets the condition in which the total energy consumption information is generated. [Setting range] 0: Disable 1 to 2,147,483,647 (Wh)	A	0	Wh	18363 (47BBh)
36732 (8F7Ch)	36733 (8F7Dh)	Tripmeter 0 information (INFO-TRIP0)	Sets the condition in which the tripmeter 0 information is generated. [Setting range] 0: Disable 1 to 2,147,483,647 (1=0.1 krev)	A	0	1=0.1 krev	18366 (47BEh)
36734 (8F7Eh)	36735 (8F7Fh)	Tripmeter 1 information (INFO-TRIP1)	Sets the condition in which the tripmeter 1 information is generated. [Setting range] 0: Disable 1 to 2,147,483,647 (1=0.1 krev)	A	0	1=0.1 krev	18367 (47BFh)
36736 (8F80h)	36737 (8F81h)	Odometer information (INFO-ODO)	Sets the condition in which the odometer information is generated. [Setting range] 0: Disable 1 to 2,147,483,647 (1=0.1 krev)	A	0	1=0.1 krev	18368 (47C0h)
36738 (8F82h)	36739 (8F83h)	Cumulative load 0 information (INFO-CULD0)	Sets the condition in which the cumulative load 0 information is generated. [Setting range] 0 to 2,147,483,647	A	0	–	18369 (47C1h)
36740 (8F84h)	36741 (8F85h)	Cumulative load 1 information (INFO-CULD1)	Sets the condition in which the cumulative load 1 information is generated. [Setting range] 0 to 2,147,483,647	A	0	–	18370 (47C2h)
36742 (8F86h)	36743 (8F87h)	Cumulative load value auto clear	Clears the cumulative load when operation is started (at the ON edge of the MOVE output). [Setting range] 0: Disable 1: Enable	A	1	–	18371 (47C3h)
36744 (8F88h)	36745 (8F89h)	Cumulative load value count divisor	Sets the divisor of the cumulative load. [Setting range] 1 to 32,767	A	1	–	18372 (47C4h)

Modbus communication register address		Name	Description	Update	Initial setting		NET-ID
Upper	Lower				Initial value	Unit	
36750 (8F8Eh)	36751 (8F8Fh)	RS-485 communication error information (INFO-485-ERR)	Sets the condition in which the RS-485 communication error information is generated. [Setting range] 0: Disable 1 to 10 times	A	0	–	18375 (47C7h)
36752 (8F90h)	36753 (8F91h)	RS-485 communication processing time information (INFO-485-PRCST)	Sets the condition in which the RS-485 communication processing time information is generated. [Setting range] 0: Disable 1 to 10,000 ms	A	0	ms	18376 (47C8h)
36754 (8F92h)	36755 (8F93h)	RS-485 communication interval information (INFO-485-INTVL)	Sets the condition in which the RS-485 communication interval information is generated. [Setting range] 0: Disable 1 to 10,000 ms	A	0	ms	18377 (47C9h)
36776 (8FA8h)	36777 (8FA9h)	CPU load information (NIFO-CPU-LOAD)	Sets the condition in which the CPU load information is generated. [Setting range] 0: Disable 1 to 100%	A	0	%	18388 (47D4h)
36778 (8FAAh)	36779 (8FABh)	Total uptime information (INFO-PTIME)	Sets the condition in which the total uptime information is generated. [Setting range] 0: Disable 1 to 30,000,000 min	A	0	min	18389 (47D5h)
36780 (8FACH)	36781 (8FADh)	Number of boots information (INFO-PCOUNT)	Sets the condition in which the number of boots information is generated. [Setting range] 0: Disable 1 to 2,147,483,647 times	A	0	–	18390 (47D6h)

13-13 USB and LED functions

Modbus communication register address		Name	Description	Update	Initial setting		NET-ID
Upper	Lower				Initial value	Unit	
976 (03D0h)	977 (03D1h)	Number of times the GREEN LED blinks at booting	The COMM LED can blink in green when the main power supply is turned on. [Setting range] 0 to 9 times	A	0	–	488 (01E8h)
978 (03D2h)	979 (03D3h)	Number of times the RED LED blinks at booting	The COMM LED can blink in red when the main power supply is turned on. [Setting range] 0 to 9 times	A	0	–	489 (01E9h)
980 (03D4h)	981 (03D5h)	Number of times the BLUE LED blinks at booting	The COMM LED can blink in blue when the main power supply is turned on. [Setting range] 0 to 9 times	A	0	–	490 (01EAh)
996 (03E4h)	997 (03E5h)	USB-ID enable	Sets the USB-ID enable to fix the COM port. (⇒ p.399) [Setting range] 0: Disable 1: Enable	D	1	–	498 (01F2h)
998 (03E6h)	999 (03E7h)	USB-ID	This can be set when the "USB-ID enable" parameter is set to "Enable." Sets the ID to the COM port. (⇒ p.399) [Setting range] 0 to 999,999,999	D	0	–	499 (01F3h)
1000 (03E8h)	1001 (03E9h)	USB-PID	Sets the product ID to be displayed in the COM port. (⇒ p.400) [Setting range] 0 to 31	D	0	–	500 (01F4h)
1002 (03EAh)	1003 (03EBh)	LED-OUT mode	Sets the information to be indicated by the PWR/SYS LED and the COMM LED. [Setting range] Refer to the table below.	A	1	–	501 (01F5h)
1004 (03ECh)	1005 (03EDh)	LED-OUT-GREEN function (I/O status output)	Selects the output signal to be indicated by the green LED. * [Setting range] ⇒ "2-2 Output signals list" on p.154	A	128: CONST-OFF	–	502 (01F6h)
1006 (03EEh)	1007 (03EFh)	LED-OUT-GREEN inverting mode (I/O status output)	Sets whether to invert ON/OFF when the internal I/O is output with LED-OUT-GREEN. [Setting range] 0: Not invert 1: Invert	A	0	–	503 (01F7h)
1008 (03F0h)	1009 (03F1h)	LED-OUT-RED function (I/O status output)	Selects the output signal to be indicated by the red LED. * [Setting range] ⇒ "2-2 Output signals list" on p.154	A	128: CONST-OFF	–	504 (01F8h)

Modbus communication register address		Name	Description	Update	Initial setting		NET-ID
Upper	Lower				Initial value	Unit	
1010 (03F2h)	1011 (03F3h)	LED-OUT-RED inverting mode (I/O status output)	Sets whether to invert ON/OFF when the internal I/O is output with LED-OUT-RED. [Setting range] 0: Not invert 1: Invert	A	0	–	505 (01F9h)
1012 (03F4h)	1013 (03F5h)	LED-OUT-BLUE function (I/O status output)	Selects the output signal to be indicated by the blue LED. * [Setting range] ⇒ "2-2 Output signals list" on p.154	A	128: CONST-OFF	–	506 (01FAh)
1014 (03F6h)	1015 (03F7h)	LED-OUT-BLUE inverting mode (I/O status output)	Sets whether to invert ON/OFF when the internal I/O is output with LED-OUT-BLUE. [Setting range] 0: Not invert 1: Invert	A	0	–	507 (01FBh)
1016 (03F8h)	1017 (03F9h)	LED (PWR/C-DAT) color changing	The lighting colors of the PWR/SYS LED and the COMM LED can be changed. [Setting range] 0: Green 1: White	A	1	–	508 (01FCh)

* It operates only when the "LED-OUT mode" parameter is set to "0."

Setting value	LED status	
	PWR/SYS	COMM
–3	No LED output *	
–2	No LED output (Except when an alarm is present)	
–1	Normal operation	No LED output
0		I/O status
1		Normal operation

* The PWR/SYS LED is lit in red for maximum one second when the main power supply is turned on.

■ USB-ID

The USB-ID is a parameter to associate the USB port (COM port number) of a PC with the driver. The COM port number is used when the communication port is set with the support software. If multiple drivers are connected to a PC, the PC allocates empty COM ports to the drivers in the connected order. If the driver power is turned on again or if the UBS cable is removed and inserted, the allocated COM port numbers may be changed because the order of connection recognized by the PC is changed.

● When the USB-ID is not set

COM port number	Connection status
1	Connected
2	Connected
3	Empty
4	Connected
5	Empty
6	Empty

← COM port on the driver that the power was supplied first
 ← COM port on the driver that the power was supplied second
 ← COM port on the driver that the power was supplied third

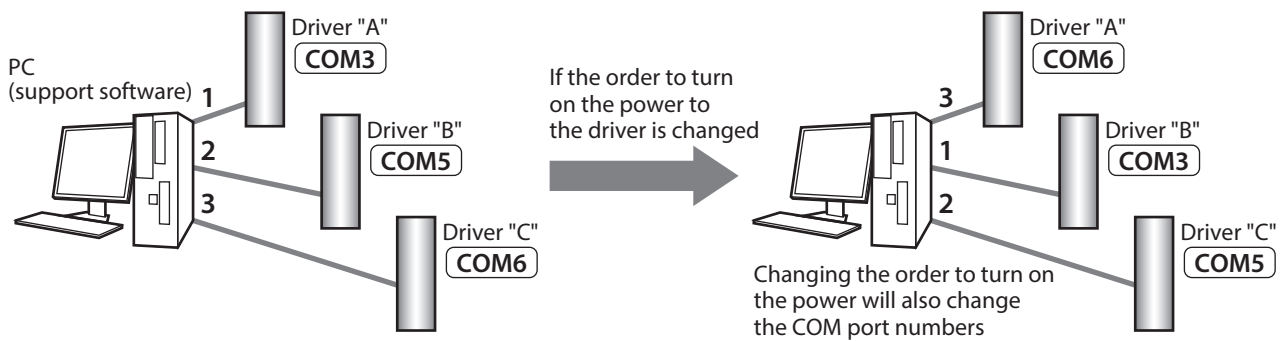

● When the USB-ID is set

If the "USB-ID" parameter is set, the same COM port numbers are always displayed regardless of the order of connection because the COM port number is fixed to each driver. (The USB-ID and the COM port number may not match because a PC associates with empty COM port numbers in descending order.)

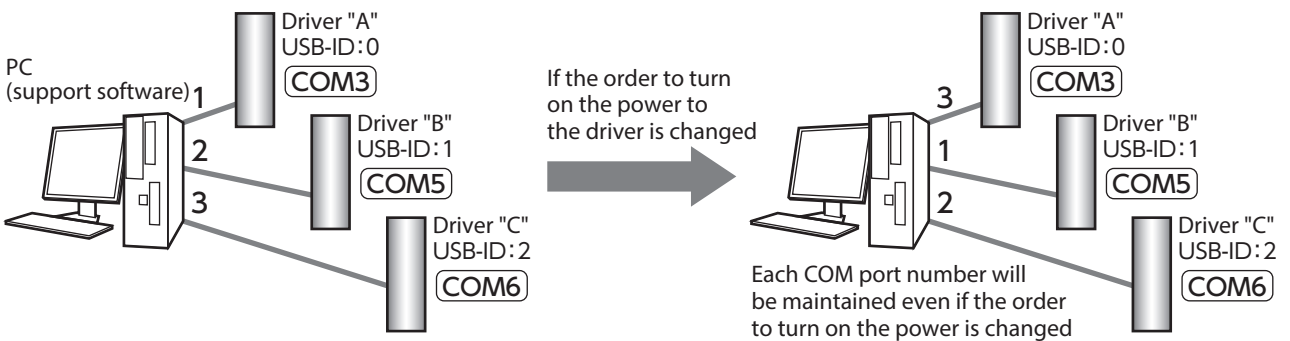

Note The COM port number set with the "USB-ID" parameter is disabled if the PC is changed.

■ USB-PID

Although the USB-ID can fix the COM port number to each driver, changing the PC will also change and disable the COM port numbers.

Meanwhile, the USB-PID is a parameter to set an ID number to the driver itself. Even if the PC or the COM port number is changed, the product can easily be distinguished using the support software because the ID number of the driver is not changed.

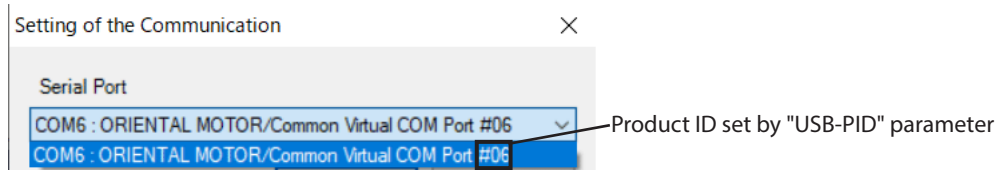

memo If USB-PID with the same number is set to multiple drivers, COM port numbers are allocated in the connected order.

13-14 User output function selection

Modbus communication register address		Name	Description	Update	Initial setting		NET-ID
Upper	Lower				Initial value	Unit	
35840 (8C00h)	35841 (8C01h)	User output (USR-OUT0) (IO) operation mode	Selects the operation mode of the user output. [Setting range] 0: Internal IO judgment 1: Value judgment (value X, value Y) = (value A, value B) 2: Value judgment (value X, value Y) = (value of NET-ID = A, value B) 3: Value judgment (value X, value Y) = (value A, value of NET-ID = B) 4: Value Judgment (value X, value Y) = (value of NET-ID = A, value of NET-ID = B)	C	0	–	17920 (4600h)
35842 (8C02h)	35843 (8C03h)	User output (USR-OUT1) (IO) operation mode		C	0	–	17921 (4601h)
35844 (8C04h)	35845 (8C05h)	User output (USR-OUT2) (IO) operation mode		C	0	–	17922 (4602h)
35846 (8C06h)	35847 (8C07h)	User output (USR-OUT3) (IO) operation mode		C	0	–	17923 (4603h)
35848 (8C08h)	35849 (8C09h)	User output (USR-OUT4) (IO) operation mode		C	0	–	17924 (4604h)
35850 (8C0Ah)	35851 (8C0Bh)	User output (USR-OUT5) (IO) operation mode		C	0	–	17925 (4605h)
35852 (8C0Ch)	35853 (8C0Dh)	User output (USR-OUT6) (IO) operation mode		C	0	–	17926 (4606h)
35854 (8C0Eh)	35855 (8C0Fh)	User output (USR-OUT7) (IO) operation mode		C	0	–	17927 (4607h)
35872 (8C20h)	35873 (8C21h)	User output (USR-OUT0) (IO) source A function	Selects the user output source A function (output signal) for USR-OUT0 to USR-OUT7. This is the setting when the operation mode is set to internal IO judgment. [Setting range] ⇨ "2-2 Output signals list" on p.154	C	128: CONST-OFF	–	17936 (4610h)
35874 (8C22h)	35875 (8C23h)	User output (USR-OUT1) (IO) source A function		C	128: CONST-OFF	–	17937 (4611h)
35876 (8C24h)	35877 (8C25h)	User output (USR-OUT2) (IO) source A function		C	128: CONST-OFF	–	17938 (4612h)
35878 (8C26h)	35879 (8C27h)	User output (USR-OUT3) (IO) source A function		C	128: CONST-OFF	–	17939 (4613h)
35880 (8C28h)	35881 (8C29h)	User output (USR-OUT4) (IO) source A function		C	128: CONST-OFF	–	17940 (4614h)
35882 (8C2Ah)	35883 (8C2Bh)	User output (USR-OUT5) (IO) source A function		C	128: CONST-OFF	–	17941 (4615h)
35884 (8C2Ch)	35885 (8C2Dh)	User output (USR-OUT6) (IO) source A function		C	128: CONST-OFF	–	17942 (4616h)
35886 (8C2Eh)	35887 (8C2Fh)	User output (USR-OUT7) (IO) source A function		C	128: CONST-OFF	–	17943 (4617h)

Modbus communication register address		Name	Description	Update	Initial setting		NET-ID
Upper	Lower				Initial value	Unit	
35904 (8C40h)	35905 (8C41h)	User output (USR-OUT0) (IO) source A inverting mode	Changes ON/OFF of the user output source A. This is the setting when the operation mode is set to internal IO judgment. [Setting range] 0: Not invert 1: Invert	C	0	–	17952 (4620h)
35906 (8C42h)	35907 (8C43h)	User output (USR-OUT1) (IO) source A inverting mode		C	0	–	17953 (4621h)
35908 (8C44h)	35909 (8C45h)	User output (USR-OUT2) (IO) source A inverting mode		C	0	–	17954 (4622h)
35910 (8C46h)	35911 (8C47h)	User output (USR-OUT3) (IO) source A inverting mode		C	0	–	17955 (4623h)
35912 (8C48h)	35913 (8C49h)	User output (USR-OUT4) (IO) source A inverting mode		C	0	–	17956 (4624h)
35914 (8C4Ah)	35915 (8C4Bh)	User output (USR-OUT5) (IO) source A inverting mode		C	0	–	17957 (4625h)
35916 (8C4Ch)	35917 (8C4Dh)	User output (USR-OUT6) (IO) source A inverting mode		C	0	–	17958 (4626h)
35918 (8C4Eh)	35919 (8C4Fh)	User output (USR-OUT7) (IO) source A inverting mode		C	0	–	17959 (4627h)
35936 (8C60h)	35937 (8C61h)	User output (USR-OUT0) (IO) source B function	Selects the user output source B function (output signal) for USR-OUT0 to USR-OUT7. This is the setting when the operation mode is set to internal IO judgment. [Setting range] ⇒ "2-2 Output signals list" on p.154	C	128: CONST-OFF	–	17968 (4630h)
35938 (8C62h)	35939 (8C63h)	User output (USR-OUT1) (IO) source B function		C	128: CONST-OFF	–	17969 (4631h)
35940 (8C64h)	35941 (8C65h)	User output (USR-OUT2) (IO) source B function		C	128: CONST-OFF	–	17970 (4632h)
35942 (8C66h)	35943 (8C67h)	User output (USR-OUT3) (IO) source B function		C	128: CONST-OFF	–	17971 (4633h)
35944 (8C68h)	35945 (8C69h)	User output (USR-OUT4) (IO) source B function		C	128: CONST-OFF	–	17972 (4634h)
35946 (8C6Ah)	35947 (8C6Bh)	User output (USR-OUT5) (IO) source B function		C	128: CONST-OFF	–	17973 (4635h)
35948 (8C6Ch)	35949 (8C6Dh)	User output (USR-OUT6) (IO) source B function		C	128: CONST-OFF	–	17974 (4636h)
35950 (8C6Eh)	35951 (8C6Fh)	User output (USR-OUT7) (IO) source B function		C	128: CONST-OFF	–	17975 (4637h)

Modbus communication register address		Name	Description	Update	Initial setting		NET-ID
Upper	Lower				Initial value	Unit	
35968 (8C80h)	35969 (8C81h)	User output (USR-OUT0) (IO) source B inverting mode	Changes ON/OFF of the user output source B. This is the setting when the operation mode is set to internal IO judgment. [Setting range] 0: Not invert 1: Invert	C	0	–	17984 (4640h)
35970 (8C82h)	35971 (8C83h)	User output (USR-OUT1) (IO) source B inverting mode		C	0	–	17985 (4641h)
35972 (8C84h)	35973 (8C85h)	User output (USR-OUT2) (IO) source B inverting mode		C	0	–	17986 (4642h)
35974 (8C86h)	35975 (8C87h)	User output (USR-OUT3) (IO) source B inverting mode		C	0	–	17987 (4643h)
35976 (8C88h)	35977 (8C89h)	User output (USR-OUT4) (IO) source B inverting mode		C	0	–	17988 (4644h)
35978 (8C8Ah)	35979 (8C8Bh)	User output (USR-OUT5) (IO) source B inverting mode		C	0	–	17989 (4645h)
35980 (8C8Ch)	35981 (8C8Dh)	User output (USR-OUT6) (IO) source B inverting mode		C	0	–	17990 (4646h)
35982 (8C8Eh)	35983 (8C8Fh)	User output (USR-OUT7) (IO) source B inverting mode		C	0	–	17991 (4647h)
36000 (8CA0h)	36001 (8CA1h)	User output (USR-OUT0) (IO) logical operation	Sets the logical combination of user output source A and user output source B. This is the setting when the operation mode is set to internal IO judgment. [Setting range] 0: AND 1 OR	C	1	–	18000 (4650h)
36002 (8CA2h)	36003 (8CA3h)	User output (USR-OUT1) (IO) logical operation		C	1	–	18001 (4651h)
36004 (8CA4h)	36005 (8CA5h)	User output (USR-OUT2) (IO) logical operation		C	1	–	18002 (4652h)
36006 (8CA6h)	36007 (8CA7h)	User output (USR-OUT3) (IO) logical operation		C	1	–	18003 (4653h)
36008 (8CA8h)	36009 (8CA9h)	User output (USR-OUT4) (IO) logical operation		C	1	–	18004 (4654h)
36010 (8CAAh)	36011 (8CABh)	User output (USR-OUT5) (IO) logical operation		C	1	–	18005 (4655h)
36012 (8CACH)	36013 (8CADh)	User output (USR-OUT6) (IO) logical operation		C	1	–	18006 (4656h)
36014 (8CAEh)	36015 (8CAFh)	User output (USR-OUT7) (IO) logical operation		C	1	–	18007 (4657h)

Modbus communication register address		Name	Description	Update	Initial setting		NET-ID	
Upper	Lower				Initial value	Unit		
36032 (8CC0h)	36033 (8CC1h)	User output (USR-OUT0) (value) ON condition	Selects the ON condition of the user output. This is the setting when the operation mode is set to value judgment.	C	0	–	18016 (4660h)	
36034 (8CC2h)	36035 (8CC3h)	User output (USR-OUT1) (value) ON condition	[Setting range] 0: (value of target NET-ID + value Y) = (value X) 1: (target NET-ID value + value Y) < (value X) 2: (value of target NET-ID + value Y) ≤ (value X) 3: (value X) < (value of target NET-ID + value Y) 4: (value X) ≤ (value of target NET-ID + value Y) 5: (value of target NET-ID) < (value X) or (value Y) < (value of target NET-ID) 6: (value of target NET-ID) ≤ (value X) or (value Y) ≤ (value of target NET-ID) 7: (value X) < (value of target NET-ID) <(value Y) 8: (value X) ≤ (value of target NET-ID) ≤ (value Y) 9: (value Y) = ((value of target NET-ID) And (value X)) 10: (value Y) = ((value of target NET-ID) Or (value X)) 11: ((value of target NET-ID) And (value X)) is not 0	C	0	–	18017 (4661h)	
36036 (8CC4h)	36037 (8CC5h)	User output (USR-OUT2) (value) ON condition		C	0	–	18018 (4662h)	
36038 (8CC6h)	36039 (8CC7h)	User output (USR-OUT3) (value) ON condition		C	0	–	18019 (4663h)	
36040 (8CC8h)	36041 (8CC9h)	User output (USR-OUT4) (value) ON condition		C	0	–	18020 (4664h)	
36042 (8CCAh)	36043 (8CCBh)	User output (USR-OUT5) (value) ON condition		C	0	–	18021 (4665h)	
36044 (8CCCh)	36045 (8CCDh)	User output (USR-OUT6) (value) ON condition		C	0	–	18022 (4666h)	
36046 (8CCEh)	36047 (8CCFh)	User output (USR-OUT7) (value) ON condition		C	0	–	18023 (4667h)	
36064 (8CE0h)	36065 (8CE1h)	User output (USR-OUT0) (value) target NET-ID		Sets the target NET-ID of the user output. This is the setting when the operation mode is set to value judgment. [Setting range] 0 to 65,535	C	0	–	18032 (4670h)
36066 (8CE2h)	36067 (8CE3h)	User output (USR-OUT1) (value) target NET-ID			C	0	–	18033 (4671h)
36068 (8CE4h)	36069 (8CE5h)	User output (USR-OUT2) (value) target NET-ID			C	0	–	18034 (4672h)
36070 (8CE6h)	36071 (8CE7h)	User output (USR-OUT3) (value) target NET-ID			C	0	–	18035 (4673h)
36072 (8CE8h)	36073 (8CE9h)	User output (USR-OUT4) (value) target NET-ID	C		0	–	18036 (4674h)	
36074 (8CEAh)	36075 (8CEBh)	User output (USR-OUT5) (value) target NET-ID	C		0	–	18037 (4675h)	
36076 (8CECh)	36077 (8CEDh)	User output (USR-OUT6) (value) target NET-ID	C		0	–	18038 (4676h)	
36078 (8CEEh)	36079 (8CEFh)	User output (USR-OUT7) (value) target NET-ID	C		0	–	18039 (4677h)	

Modbus communication register address		Name	Description	Update	Initial setting		NET-ID	
Upper	Lower				Initial value	Unit		
36096 (8D00h)	36097 (8D01h)	User output (USR-OUT0) (value) value A	Sets the value A of the user ID. This is the setting when the operation mode is set to value judgment. [Setting range] -2,147,483,648 to 2,147,483,647	A	0	-	18048 (4680h)	
36098 (8D02h)	36099 (8D03h)	User output (USR-OUT1) (value) value A		A	0	-	18049 (4681h)	
36100 (8D04h)	36101 (8D05h)	User output (USR-OUT2) (value) value A		A	0	-	18050 (4682h)	
36102 (8D06h)	36103 (8D07h)	User output (USR-OUT3) (value) value A		A	0	-	18051 (4683h)	
36104 (8D08h)	36105 (8D09h)	User output (USR-OUT4) (value) value A		A	0	-	18052 (4684h)	
36106 (8D0Ah)	36107 (8D0Bh)	User output (USR-OUT5) (value) value A		A	0	-	18053 (4685h)	
36108 (8D0Ch)	36109 (8D0Dh)	User output (USR-OUT6) (value) value A		A	0	-	18054 (4686h)	
36110 (8D0Eh)	36111 (8D0Fh)	User output (USR-OUT7) (value) value A		A	0	-	18055 (4687h)	
36128 (8D20h)	36129 (8D21h)	User output (USR-OUT0) (value) value B		Sets the value B of the user output. This is the setting when the operation mode is set to value judgment. [Setting range] -2,147,483,648 to 2,147,483,647	A	0	-	18064 (4690h)
36130 (8D22h)	36131 (8D23h)	User output (USR-OUT1) (value) value B			A	0	-	18065 (4691h)
36132 (8D24h)	36133 (8D25h)	User output (USR-OUT2) (value) value B	A		0	-	18066 (4692h)	
36134 (8D26h)	36135 (8D27h)	User output (USR-OUT3) (value) value B	A		0	-	18067 (4693h)	
36136 (8D28h)	36137 (8D29h)	User output (USR-OUT4) (value) value B	A		0	-	18068 (4694h)	
36138 (8D2Ah)	36139 (8D2Bh)	User output (USR-OUT5) (value) value B	A		0	-	18069 (4695h)	
36140 (8D2Ch)	36141 (8D2Dh)	User output (USR-OUT6) (value) value B	A		0	-	18070 (4696h)	
36142 (8D2Eh)	36143 (8D2Fh)	User output (USR-OUT7) (value) value B	A		0	-	18071 (4697h)	

13-15 Virtual input function selection (VIN)

Modbus communication register address		Name	Description	Update	Initial setting		NET-ID
Upper	Lower				Initial value	Unit	
35328 (8A00h)	35329 (8A01h)	Virtual input (VIR-IN0) function (link)	Selects the input signals to be assigned to VIR-IN0 to VIR-IN7.	C	0: Not used	–	17664 (4500h)
35330 (8A02h)	35331 (8A03h)	Virtual input (VIR-IN1) function (link)		C	0: Not used	–	17665 (4501h)
35332 (8A04h)	35333 (8A05h)	Virtual input (VIR-IN2) function (link)		C	0: Not used	–	17666 (4502h)
35334 (8A06h)	35335 (8A07h)	Virtual input (VIR-IN3) function (link)		C	0: Not used	–	17667 (4503h)
35336 (8A08h)	35337 (8A09h)	Virtual input (VIR-IN4) function (link)		C	0: Not used	–	17668 (4504h)
35338 (8A0Ah)	35339 (8A0Bh)	Virtual input (VIR-IN5) function (link)		C	0: Not used	–	17669 (4505h)
35340 (8A0Ch)	35341 (8A0Dh)	Virtual input (VIR-IN6) function (link)		C	0: Not used	–	17670 (4506h)
35342 (8A0Eh)	35343 (8A0Fh)	Virtual input (VIR-IN7) function (link)		C	0: Not used	–	17671 (4507h)
35392 (8A40h)	35393 (8A41h)	Virtual input (VIR-IN0) source A function	Selects the virtual input source A function (output signal) for VIR-IN0 to VIR-IN7. [Setting range] ⇒ "2-2 Output signals list" on p.154	C	128: CONST-OFF	–	17696 (4520h)
35394 (8A42h)	35395 (8A43h)	Virtual input (VIR-IN1) source A function		C	128: CONST-OFF	–	17697 (4521h)
35396 (8A44h)	35397 (8A45h)	Virtual input (VIR-IN2) source A function		C	128: CONST-OFF	–	17698 (4522h)
35398 (8A46h)	35399 (8A47h)	Virtual input (VIR-IN3) source A function		C	128: CONST-OFF	–	17699 (4523h)
35400 (8A48h)	35401 (8A49h)	Virtual input (VIR-IN4) source A function		C	128: CONST-OFF	–	17700 (4524h)
35402 (8A4Ah)	35403 (8A4Bh)	Virtual input (VIR-IN5) source A function		C	128: CONST-OFF	–	17701 (4525h)
35404 (8A4Ch)	35405 (8A4Dh)	Virtual input (VIR-IN6) source A function		C	128: CONST-OFF	–	17702 (4526h)
35406 (8A4Eh)	35407 (8A4Fh)	Virtual input (VIR-IN7) source A function		C	128: CONST-OFF	–	17703 (4527h)
35456 (8A80h)	35457 (8A81h)	Virtual input (VIR-IN0) source A inverting mode	Changes ON/OFF of the virtual input source A. [Setting range] 0: Not invert 1: Invert	C	0	–	17728 (4540h)
35458 (8A82h)	35459 (8A83h)	Virtual input (VIR-IN1) source A inverting mode		C	0	–	17729 (4541h)
35460 (8A84h)	35461 (8A85h)	Virtual input (VIR-IN2) source A inverting mode		C	0	–	17730 (4542h)
35462 (8A86h)	35463 (8A87h)	Virtual input (VIR-IN3) source A inverting mode		C	0	–	17731 (4543h)
35464 (8A88h)	35465 (8A89h)	Virtual input (VIR-IN4) source A inverting mode		C	0	–	17732 (4544h)
35466 (8A8Ah)	35467 (8A8Bh)	Virtual input (VIR-IN5) source A inverting mode		C	0	–	17733 (4545h)
35468 (8A8Ch)	35469 (8A8Dh)	Virtual input (VIR-IN6) source A inverting mode		C	0	–	17734 (4546h)
35470 (8A8Eh)	35471 (8A8Fh)	Virtual input (VIR-IN7) source A inverting mode		C	0	–	17735 (4547h)

Modbus communication register address		Name	Description	Update	Initial setting		NET-ID
Upper	Lower				Initial value	Unit	
35520 (8AC0h)	35521 (8AC1h)	Virtual input (VIR-IN0) source B function	Selects the virtual input source B function (output signal) for VIR-IN0 to VIR-IN7. [Setting range] ⇒ "2-2 Output signals list" on p.154	C	128: CONST-OFF	-	17760 (4560h)
35522 (8AC2h)	35523 (8AC3h)	Virtual input (VIR-IN1) source B function		C	128: CONST-OFF	-	17761 (4561h)
35524 (8AC4h)	35525 (8AC5h)	Virtual input (VIR-IN2) source B function		C	128: CONST-OFF	-	17762 (4562h)
35526 (8AC6h)	35527 (8AC7h)	Virtual input (VIR-IN3) source B function		C	128: CONST-OFF	-	17763 (4563h)
35528 (8AC8h)	35529 (8AC9h)	Virtual input (VIR-IN4) source B function		C	128: CONST-OFF	-	17764 (4564h)
35530 (8ACAh)	35531 (8ACBh)	Virtual input (VIR-IN5) source B function		C	128: CONST-OFF	-	17765 (4565h)
35532 (8ACCCh)	35533 (8ACDh)	Virtual input (VIR-IN6) source B function		C	128: CONST-OFF	-	17766 (4566h)
35534 (8ACEh)	35535 (8ACFh)	Virtual input (VIR-IN7) source B function		C	128: CONST-OFF	-	17767 (4567h)
35584 (8B00h)	35585 (8B01h)	Virtual input (VIR-IN0) source B inverting mode	Changes ON/OFF of the virtual input source B. [Setting range] 0: Not invert 1: Invert	C	0	-	17792 (4580h)
35586 (8B02h)	35587 (8B03h)	Virtual input (VIR-IN1) source B inverting mode		C	0	-	17793 (4581h)
35588 (8B04h)	35589 (8B05h)	Virtual input (VIR-IN2) source B inverting mode		C	0	-	17794 (4582h)
35590 (8B06h)	35591 (8B07h)	Virtual input (VIR-IN3) source B inverting mode		C	0	-	17795 (4583h)
35592 (8B08h)	35593 (8B09h)	Virtual input (VIR-IN4) source B inverting mode		C	0	-	17796 (4584h)
35594 (8B0Ah)	35595 (8B0Bh)	Virtual input (VIR-IN5) source B inverting mode		C	0	-	17797 (4585h)
35596 (8B0Ch)	35597 (8B0Dh)	Virtual input (VIR-IN6) source B inverting mode		C	0	-	17798 (4586h)
35598 (8B0Eh)	35599 (8B0Fh)	Virtual input (VIR-IN7) source B inverting mode		C	0	-	17799 (4587h)
35648 (8B40h)	35649 (8B41h)	Virtual input (VIR-IN0) logical operation	Sets the logical combination of virtual input source A and virtual input source B. [Setting range] 0: AND 1 OR	C	1	-	17824 (45A0h)
35650 (8B42h)	35651 (8B43h)	Virtual input (VIR-IN1) logical operation		C	1	-	17825 (45A1h)
35652 (8B44h)	35653 (8B45h)	Virtual input (VIR-IN2) logical operation		C	1	-	17826 (45A2h)
35654 (8B46h)	35655 (8B47h)	Virtual input (VIR-IN3) logical operation		C	1	-	17827 (45A3h)
35656 (8B48h)	35657 (8B49h)	Virtual input (VIR-IN4) logical operation		C	1	-	17828 (45A4h)
35658 (8B4Ah)	35659 (8B4Bh)	Virtual input (VIR-IN5) logical operation		C	1	-	17829 (45A5h)
35660 (8B4Ch)	35661 (8B4Dh)	Virtual input (VIR-IN6) logical operation		C	1	-	17830 (45A6h)
35662 (8B4Eh)	35663 (8B4Fh)	Virtual input (VIR-IN7) logical operation		C	1	-	17831 (45A7h)

Modbus communication register address		Name	Description	Update	Initial setting		NET-ID
Upper	Lower				Initial value	Unit	
35712 (8B80h)	35713 (8B81h)	Virtual input (VIR-IN0) ON signal dead time	Sets the ON signal dead-time for VIR-IN0 to VIR-IN7. (The input signal is turned ON when the time having set is exceeded.) [Setting range] 0 to 4,000 ms	C	0	ms	17856 (45C0h)
35714 (8B82h)	35715 (8B83h)	Virtual input (VIR-IN1) ON signal dead time		C	0	ms	17857 (45C1h)
35716 (8B84h)	35717 (8B85h)	Virtual input (VIR-IN2) ON signal dead time		C	0	ms	17858 (45C2h)
35718 (8B86h)	35719 (8B87h)	Virtual input (VIR-IN3) ON signal dead time		C	0	ms	17859 (45C3h)
35720 (8B88h)	35721 (8B89h)	Virtual input (VIR-IN4) ON signal dead time		C	0	ms	17860 (45C4h)
35722 (8B8Ah)	35723 (8B8Bh)	Virtual input (VIR-IN5) ON signal dead time		C	0	ms	17861 (45C5h)
35724 (8B8Ch)	35725 (8B8Dh)	Virtual input (VIR-IN6) ON signal dead time		C	0	ms	17862 (45C6h)
35726 (8B8Eh)	35727 (8B8Fh)	Virtual input (VIR-IN7) ON signal dead time		C	0	ms	17863 (45C7h)
35776 (8BC0h)	35777 (8BC1h)	Virtual input (VIR-IN0) 1 shot signal mode	Enables the 1-shot signal function for VIR-IN0 to VIR-IN7. (The input signal having been turned ON is automatically turned OFF after 250 μs.) [Setting range] 0: Disable 1: Enable	C	0	-	17888 (45E0h)
35778 (8BC2h)	35779 (8BC3h)	Virtual input (VIR-IN1) 1 shot signal mode		C	0	-	17889 (45E1h)
35780 (8BC4h)	35781 (8BC5h)	Virtual input (VIR-IN2) 1 shot signal mode		C	0	-	17890 (45E2h)
35782 (8BC6h)	35783 (8BC7h)	Virtual input (VIR-IN3) 1 shot signal mode		C	0	-	17891 (45E3h)
35784 (8BC8h)	35785 (8BC9h)	Virtual input (VIR-IN4) 1 shot signal mode		C	0	-	17892 (45E4h)
35786 (8BCAh)	35787 (8BCBh)	Virtual input (VIR-IN5) 1 shot signal mode		C	0	-	17893 (45E5h)
35788 (8BCCh)	35789 (8BCDh)	Virtual input (VIR-IN6) 1 shot signal mode		C	0	-	17894 (45E6h)
35790 (8BCEh)	35791 (8BCFh)	Virtual input (VIR-IN7) 1 shot signal mode		C	0	-	17895 (45E7h)

13-16 Data transfer

Modbus communication register address		Name	Description	Update	Initial setting		NET-ID
Upper	Lower				Initial value	Unit	
33792 (8400h)	33793 (8401h)	Data transfer (DTF0) trigger IO	Selects the output signal to be triggered data transfer. [Setting range] ⇒ "2-2 Output signals list" on p.154	C	0: Not used	-	16896 (4200h)
33794 (8402h)	33795 (8403h)	Data transfer (DTF1) trigger IO		C	0: Not used	-	16897 (4201h)
33796 (8404h)	33797 (8405h)	Data transfer (DTF2) trigger IO		C	0: Not used	-	16898 (4202h)
33798 (8406h)	33799 (8407h)	Data transfer (DTF3) trigger IO		C	0: Not used	-	16899 (4203h)
33800 (8408h)	33801 (8409h)	Data transfer (DTF4) trigger IO		C	0: Not used	-	16900 (4204h)

Modbus communication register address		Name	Description	Update	Initial setting		NET-ID
Upper	Lower				Initial value	Unit	
33802 (840Ah)	33803 (840Bh)	Data transfer (DTF5) trigger IO	Selects the output signal to be triggered data transfer. [Setting range] ⇒ "2-2 Output signals list" on p.154	C	0: Not used	–	16901 (4205h)
33804 (840Ch)	33805 (840Dh)	Data transfer (DTF6) trigger IO		C	0: Not used	–	16902 (4206h)
33806 (840Eh)	33807 (840Fh)	Data transfer (DTF7) trigger IO		C	0: Not used	–	16903 (4207h)
33808 (8410h)	33809 (8411h)	Data transfer (DTF8) trigger IO		C	0: Not used	–	16904 (4208h)
33810 (8412h)	33811 (8413h)	Data transfer (DTF9) trigger IO		C	0: Not used	–	16905 (4209h)
33812 (8414h)	33813 (8415h)	Data transfer (DTF10) trigger IO		C	0: Not used	–	16906 (420Ah)
33814 (8416h)	33815 (8417h)	Data transfer (DTF11) trigger IO		C	0: Not used	–	16907 (420Bh)
33816 (8418h)	33817 (8419h)	Data transfer (DTF12) trigger IO		C	0: Not used	–	16908 (420Ch)
33818 (841Ah)	33819 (841Bh)	Data transfer (DTF13) trigger IO		C	0: Not used	–	16909 (420Dh)
33820 (841Ch)	33821 (841Dh)	Data transfer (DTF14) trigger IO		C	0: Not used	–	16910 (420Eh)
33822 (841Eh)	33823 (841Fh)	Data transfer (DTF15) trigger IO		C	0: Not used	–	16911 (420Fh)
33824 (8420h)	33825 (8421h)	Data transfer (DTF16) trigger IO		C	0: Not used	–	16912 (4210h)
33826 (8422h)	33827 (8423h)	Data transfer (DTF17) trigger IO		C	0: Not used	–	16913 (4211h)
33828 (8424h)	33829 (8425h)	Data transfer (DTF18) trigger IO		C	0: Not used	–	16914 (4212h)
33830 (8426h)	33831 (8427h)	Data transfer (DTF19) trigger IO		C	0: Not used	–	16915 (4213h)
33832 (8428h)	33833 (8429h)	Data transfer (DTF20) trigger IO		C	0: Not used	–	16916 (4214h)
33834 (842Ah)	33835 (842Bh)	Data transfer (DTF21) trigger IO		C	0: Not used	–	16917 (4215h)
33836 (842Ch)	33837 (842Dh)	Data transfer (DTF22) trigger IO		C	0: Not used	–	16918 (4216h)
33838 (842Eh)	33839 (842Fh)	Data transfer (DTF23) trigger IO		C	0: Not used	–	16919 (4217h)
33840 (8430h)	33841 (8431h)	Data transfer (DTF24) trigger IO		C	0: Not used	–	16920 (4218h)
33842 (8432h)	33843 (8433h)	Data transfer (DTF25) trigger IO		C	0: Not used	–	16921 (4219h)
33844 (8434h)	33845 (8435h)	Data transfer (DTF26) trigger IO		C	0: Not used	–	16922 (421Ah)
33846 (8436h)	33847 (8437h)	Data transfer (DTF27) trigger IO		C	0: Not used	–	16923 (421Bh)
33848 (8438h)	33849 (8439h)	Data transfer (DTF28) trigger IO		C	0: Not used	–	16924 (421Ch)
33850 (843Ah)	33851 (843Bh)	Data transfer (DTF29) trigger IO		C	0: Not used	–	16925 (421Dh)

Modbus communication register address		Name	Description	Update	Initial setting		NET-ID	
Upper	Lower				Initial value	Unit		
33852 (843Ch)	33853 (843Dh)	Data transfer (DTF30) trigger IO	Selects the output signal to be triggered data transfer.	C	0: Not used	-	16926 (421Eh)	
33854 (843Eh)	33855 (843Fh)	Data transfer (DTF31) trigger IO	[Setting range] ⇒ "2-2 Output signals list" on p.154	C	0: Not used	-	16927 (421Fh)	
33856 (8440h)	33857 (8441h)	Data transfer (DTF0) trigger form		C	0	-	16928 (4220h)	
33858 (8442h)	33859 (8443h)	Data transfer (DTF1) trigger form		C	0	-	16929 (4221h)	
33860 (8444h)	33861 (8445h)	Data transfer (DTF2) trigger form		C	0	-	16930 (4222h)	
33862 (8446h)	33863 (8447h)	Data transfer (DTF3) trigger form		C	0	-	16931 (4223h)	
33864 (8448h)	33865 (8449h)	Data transfer (DTF4) trigger form		C	0	-	16932 (4224h)	
33866 (844Ah)	33867 (844Bh)	Data transfer (DTF5) trigger form		C	0	-	16933 (4225h)	
33868 (844Ch)	33869 (844Dh)	Data transfer (DTF6) trigger form		C	0	-	16934 (4226h)	
33870 (844Eh)	33871 (844Fh)	Data transfer (DTF7) trigger form		C	0	-	16935 (4227h)	
33872 (8450h)	33873 (8451h)	Data transfer (DTF8) trigger form		C	0	-	16936 (4228h)	
33874 (8452h)	33875 (8453h)	Data transfer (DTF9) trigger form		C	0	-	16937 (4229h)	
33876 (8454h)	33877 (8455h)	Data transfer (DTF10) trigger form		Selects the edge shape to be triggered.	C	0	-	16938 (422Ah)
33878 (8456h)	33879 (8457h)	Data transfer (DTF11) trigger form		[Setting range] 0: Positive-Edge 1: Negative-Edge 2: Double-Edge	C	0	-	16939 (422Bh)
33880 (8458h)	33881 (8459h)	Data transfer (DTF12) trigger form		C	0	-	16940 (422Ch)	
33882 (845Ah)	33883 (845Bh)	Data transfer (DTF13) trigger form		C	0	-	16941 (422Dh)	
33884 (845Ch)	33885 (845Dh)	Data transfer (DTF14) trigger form		C	0	-	16942 (422Eh)	
33886 (845Eh)	33887 (845Fh)	Data transfer (DTF15) trigger form		C	0	-	16943 (422Fh)	
33888 (8460h)	33889 (8461h)	Data transfer (DTF16) trigger form		C	0	-	16944 (4230h)	
33890 (8462h)	33891 (8463h)	Data transfer (DTF17) trigger form		C	0	-	16945 (4231h)	
33892 (8464h)	33893 (8465h)	Data transfer (DTF18) trigger form		C	0	-	16946 (4232h)	
33894 (8466h)	33895 (8467h)	Data transfer (DTF19) trigger form		C	0	-	16947 (4233h)	
33896 (8468h)	33897 (8469h)	Data transfer (DTF20) trigger form		C	0	-	16948 (4234h)	
33898 (846Ah)	33899 (846Bh)	Data transfer (DTF21) trigger form		C	0	-	16949 (4235h)	
33900 (846Ch)	33901 (846Dh)	Data transfer (DTF22) trigger form	C	0	-	16950 (4236h)		

Modbus communication register address		Name	Description	Update	Initial setting		NET-ID
Upper	Lower				Initial value	Unit	
33902 (846Eh)	33903 (846Fh)	Data transfer (DTF23) trigger form	Selects the edge shape to be triggered. [Setting range] 0: Positive-Edge 1: Negative-Edge 2: Double-Edge	C	0	–	16951 (4237h)
33904 (8470h)	33905 (8471h)	Data transfer (DTF24) trigger form		C	0	–	16952 (4238h)
33906 (8472h)	33907 (8473h)	Data transfer (DTF25) trigger form		C	0	–	16953 (4239h)
33908 (8474h)	33909 (8475h)	Data transfer (DTF26) trigger form		C	0	–	16954 (423Ah)
33910 (8476h)	33911 (8477h)	Data transfer (DTF27) trigger form		C	0	–	16955 (423Bh)
33912 (8478h)	33913 (8479h)	Data transfer (DTF28) trigger form		C	0	–	16956 (423Ch)
33914 (847Ah)	33915 (847Bh)	Data transfer (DTF29) trigger form		C	0	–	16957 (423Dh)
33916 (847Ch)	33917 (847Dh)	Data transfer (DTF30) trigger form		C	0	–	16958 (423Eh)
33918 (847Eh)	33919 (847Fh)	Data transfer (DTF31) trigger form		C	0	–	16959 (423Fh)
33920 (8480h)	33921 (8481h)	Data transfer (DTF0) transfer mode		Selects the transfer mode of data transfer. [Setting range] 0: Transfers the value of the argument NET-ID to the target NET-ID 1: Transfers the value of the argument NET-ID to the target NET-ID with AND-Logic synthesis 2: Transfers the value of the argument NET-ID to the target NET-ID with OR-Logic synthesis 3: Transfers the value of the argument NET-ID to the target NET-ID with CLR-Logic synthesis 4: Transfers the value of the argument NET-ID to the target NET-ID with Additive function 8: Transfers the value of the argument to the target NET-ID 9: Transfers the value of the argument to the target NET-ID with AND-Logic synthesis 10: Transfers the value of the argument to the target NET-ID with OR-Logic synthesis 11: Transfers the value of the argument to the target NET-ID with CLR-Logic synthesis 12: Transfers the value of the argument to the target NET-ID with Additive function	C	0	–
33922 (8482h)	33923 (8483h)	Data transfer (DTF1) transfer mode	C		0	–	16961 (4241h)
33924 (8484h)	33925 (8485h)	Data transfer (DTF2) transfer mode	C		0	–	16962 (4242h)
33926 (8486h)	33927 (8487h)	Data transfer (DTF3) transfer mode	C		0	–	16963 (4243h)
33928 (8488h)	33929 (8489h)	Data transfer (DTF4) transfer mode	C		0	–	16964 (4244h)
33930 (848Ah)	33931 (848Bh)	Data transfer (DTF5) transfer mode	C		0	–	16965 (4245h)
33932 (848Ch)	33933 (848Dh)	Data transfer (DTF6) transfer mode	C		0	–	16966 (4246h)
33934 (848Eh)	33935 (848Fh)	Data transfer (DTF7) transfer mode	C		0	–	16967 (4247h)
33936 (8490h)	33937 (8491h)	Data transfer (DTF8) transfer mode	C		0	–	16968 (4248h)
33938 (8492h)	33939 (8493h)	Data transfer (DTF9) transfer mode	C		0	–	16969 (4249h)
33940 (8494h)	33941 (8495h)	Data transfer (DTF10) transfer mode	C		0	–	16970 (424Ah)
33942 (8496h)	33943 (8497h)	Data transfer (DTF11) transfer mode	C		0	–	16971 (424Bh)
33944 (8498h)	33945 (8499h)	Data transfer (DTF12) transfer mode	C		0	–	16972 (424Ch)
33946 (849Ah)	33947 (849Bh)	Data transfer (DTF13) transfer mode	C		0	–	16973 (424Dh)
33948 (849Ch)	33949 (849Dh)	Data transfer (DTF14) transfer mode	C		0	–	16974 (424Eh)
33950 (849Eh)	33951 (849Fh)	Data transfer (DTF15) transfer mode	C	0	–	16975 (424Fh)	

Modbus communication register address		Name	Description	Update	Initial setting		NET-ID
Upper	Lower				Initial value	Unit	
33952 (84A0h)	33953 (84A1h)	Data transfer (DTF16) transfer mode	Selects the transfer mode of data transfer. [Setting range] 0: Transfers the value of the argument NET-ID to the target NET-ID 1: Transfers the value of the argument NET-ID to the target NET-ID with AND-Logic synthesis 2: Transfers the value of the argument NET-ID to the target NET-ID with OR-Logic synthesis 3: Transfers the value of the argument NET-ID to the target NET-ID with CLR-Logic synthesis 4: Transfers the value of the argument NET-ID to the target NET-ID with Additive function 8: Transfers the value of the argument to the target NET-ID 9: Transfers the value of the argument to the target NET-ID with AND-Logic synthesis 10: Transfers the value of the argument to the target NET-ID with OR-Logic synthesis 11: Transfers the value of the argument to the target NET-ID with CLR-Logic synthesis 12: Transfers the value of the argument to the target NET-ID with Additive function	C	0	–	16976 (4250h)
33954 (84A2h)	33955 (84A3h)	Data transfer (DTF17) transfer mode		C	0	–	16977 (4251h)
33956 (84A4h)	33957 (84A5h)	Data transfer (DTF18) transfer mode		C	0	–	16978 (4252h)
33958 (84A6h)	33959 (84A7h)	Data transfer (DTF19) transfer mode		C	0	–	16979 (4253h)
33960 (84A8h)	33961 (84A9h)	Data transfer (DTF20) transfer mode		C	0	–	16980 (4254h)
33962 (84AAh)	33963 (84ABh)	Data transfer (DTF21) transfer mode		C	0	–	16981 (4255h)
33964 (84ACh)	33965 (84ADh)	Data transfer (DTF22) transfer mode		C	0	–	16982 (4256h)
33966 (84AEh)	33967 (84AFh)	Data transfer (DTF23) transfer mode		C	0	–	16983 (4257h)
33968 (84B0h)	33969 (84B1h)	Data transfer (DTF24) transfer mode		C	0	–	16984 (4258h)
33970 (84B2h)	33971 (84B3h)	Data transfer (DTF25) transfer mode		C	0	–	16985 (4259h)
33972 (84B4h)	33973 (84B5h)	Data transfer (DTF26) transfer mode		C	0	–	16986 (425Ah)
33974 (84B6h)	33975 (84B7h)	Data transfer (DTF27) transfer mode		C	0	–	16987 (425Bh)
33976 (84B8h)	33977 (84B9h)	Data transfer (DTF28) transfer mode		C	0	–	16988 (425Ch)
33978 (84BAh)	33979 (84BBh)	Data transfer (DTF29) transfer mode		C	0	–	16989 (425Dh)
33980 (84BCh)	33981 (84BDh)	Data transfer (DTF30) transfer mode		C	0	–	16990 (425Eh)
33982 (84BEh)	33983 (84BFh)	Data transfer (DTF31) transfer mode	C	0	–	16991 (425Fh)	
33984 (84C0h)	33985 (84C1h)	Data transfer (DTF0) argument	Sets the value or NET-ID (data source) to be transferred in data transfer. [Setting range] –2,147,483,648 to 2,147,483,647	A	0	–	16992 (4260h)
33986 (84C2h)	33987 (84C3h)	Data transfer (DTF1) argument		A	0	–	16993 (4261h)
33988 (84C4h)	33989 (84C5h)	Data transfer (DTF2) argument		A	0	–	16994 (4262h)
33990 (84C6h)	33991 (84C7h)	Data transfer (DTF3) argument		A	0	–	16995 (4263h)
33992 (84C8h)	33993 (84C9h)	Data transfer (DTF4) argument		A	0	–	16996 (4264h)
33994 (84CAh)	33995 (84CBh)	Data transfer (DTF5) argument		A	0	–	16997 (4265h)
33996 (84CCh)	33997 (84CDh)	Data transfer (DTF6) argument		A	0	–	16998 (4266h)
33998 (84CEh)	33999 (84CFh)	Data transfer (DTF7) argument		A	0	–	16999 (4267h)
34000 (84D0h)	34001 (84D1h)	Data transfer (DTF8) argument		A	0	–	17000 (4268h)

Modbus communication register address		Name	Description	Update	Initial setting		NET-ID
Upper	Lower				Initial value	Unit	
34002 (84D2h)	34003 (84D3h)	Data transfer (DTF9) argument	Sets the value or NET-ID (data source) to be transferred in data transfer. [Setting range] -2,147,483,648 to 2,147,483,647	A	0	-	17001 (4269h)
34004 (84D4h)	34005 (84D5h)	Data transfer (DTF10) argument		A	0	-	17002 (426Ah)
34006 (84D6h)	34007 (84D7h)	Data transfer (DTF11) argument		A	0	-	17003 (426Bh)
34008 (84D8h)	34009 (84D9h)	Data transfer (DTF12) argument		A	0	-	17004 (426Ch)
34010 (84DAh)	34011 (84DBh)	Data transfer (DTF13) argument		A	0	-	17005 (426Dh)
34012 (84DCh)	34013 (84DDh)	Data transfer (DTF14) argument		A	0	-	17006 (426Eh)
34014 (84DEh)	34015 (84DFh)	Data transfer (DTF15) argument		A	0	-	17007 (426Fh)
34016 (84E0h)	34017 (84E1h)	Data transfer (DTF16) argument		A	0	-	17008 (4270h)
34018 (84E2h)	34019 (84E3h)	Data transfer (DTF17) argument		A	0	-	17009 (4271h)
34020 (84E4h)	34021 (84E5h)	Data transfer (DTF18) argument		A	0	-	17010 (4272h)
34022 (84E6h)	34023 (84E7h)	Data transfer (DTF19) argument		A	0	-	17011 (4273h)
34024 (84E8h)	34025 (84E9h)	Data transfer (DTF20) argument		A	0	-	17012 (4274h)
34026 (84EAh)	34027 (84EBh)	Data transfer (DTF21) argument		A	0	-	17013 (4275h)
34028 (84ECh)	34029 (84EDh)	Data transfer (DTF22) argument		A	0	-	17014 (4276h)
34030 (84EEh)	34031 (84EFh)	Data transfer (DTF23) argument		A	0	-	17015 (4277h)
34032 (84F0h)	34033 (84F1h)	Data transfer (DTF24) argument		A	0	-	17016 (4278h)
34034 (84F2h)	34035 (84F3h)	Data transfer (DTF25) argument		A	0	-	17017 (4279h)
34036 (84F4h)	34037 (84F5h)	Data transfer (DTF26) argument		A	0	-	17018 (427Ah)
34038 (84F6h)	34039 (84F7h)	Data transfer (DTF27) argument		A	0	-	17019 (427Bh)
34040 (84F8h)	34041 (84F9h)	Data transfer (DTF28) argument		A	0	-	17020 (427Ch)
34042 (84FAh)	34043 (84FBh)	Data transfer (DTF29) argument		A	0	-	17021 (427Dh)
34044 (84FCh)	34045 (84FDh)	Data transfer (DTF30) argument		A	0	-	17022 (427Eh)
34046 (84FEh)	34047 (84FFh)	Data transfer (DTF31) argument		A	0	-	17023 (427Fh)
34048 (8500h)	34049 (8501h)	Data transfer (DTF0) target NET-ID		Sets the NET-ID (data destination) to be transferred in data transfer. [Setting range] 0 to 65,535	A	0	-
34050 (8502h)	34051 (8503h)	Data transfer (DTF1) target NET-ID	A		0	-	17025 (4281h)

Modbus communication register address		Name	Description	Update	Initial setting		NET-ID
Upper	Lower				Initial value	Unit	
34052 (8504h)	34053 (8505h)	Data transfer (DTF2) target NET-ID	Sets the NET-ID (data destination) to be transferred in data transfer. [Setting range] 0 to 65,535	A	0	–	17026 (4282h)
34054 (8506h)	34055 (8507h)	Data transfer (DTF3) target NET-ID		A	0	–	17027 (4283h)
34056 (8508h)	34057 (8509h)	Data transfer (DTF4) target NET-ID		A	0	–	17028 (4284h)
34058 (850Ah)	34059 (850Bh)	Data transfer (DTF5) target NET-ID		A	0	–	17029 (4285h)
34060 (850Ch)	34061 (850Dh)	Data transfer (DTF6) target NET-ID		A	0	–	17030 (4286h)
34062 (850Eh)	34063 (850Fh)	Data transfer (DTF7) target NET-ID		A	0	–	17031 (4287h)
34064 (8510h)	34065 (8511h)	Data transfer (DTF8) target NET-ID		A	0	–	17032 (4288h)
34066 (8512h)	34067 (8513h)	Data transfer (DTF9) target NET-ID		A	0	–	17033 (4289h)
34068 (8514h)	34069 (8515h)	Data transfer (DTF10) target NET-ID		A	0	–	17034 (428Ah)
34070 (8516h)	34071 (8517h)	Data transfer (DTF11) target NET-ID		A	0	–	17035 (428Bh)
34072 (8518h)	34073 (8519h)	Data transfer (DTF12) target NET-ID		A	0	–	17036 (428Ch)
34074 (851Ah)	34075 (851Bh)	Data transfer (DTF13) target NET-ID		A	0	–	17037 (428Dh)
34076 (851Ch)	34077 (851Dh)	Data transfer (DTF14) target NET-ID		A	0	–	17038 (428Eh)
34078 (851Eh)	34079 (851Fh)	Data transfer (DTF15) target NET-ID		A	0	–	17039 (428Fh)
34080 (8520h)	34081 (8521h)	Data transfer (DTF16) target NET-ID		A	0	–	17040 (4290h)
34082 (8522h)	34083 (8523h)	Data transfer (DTF17) target NET-ID		A	0	–	17041 (4291h)
34084 (8524h)	34085 (8525h)	Data transfer (DTF18) target NET-ID		A	0	–	17042 (4292h)
34086 (8526h)	34087 (8527h)	Data transfer (DTF19) target NET-ID		A	0	–	17043 (4293h)
34088 (8528h)	34089 (8529h)	Data transfer (DTF20) target NET-ID		A	0	–	17044 (4294h)
34090 (852Ah)	34091 (852Bh)	Data transfer (DTF21) target NET-ID		A	0	–	17045 (4295h)
34092 (852Ch)	34093 (852Dh)	Data transfer (DTF22) target NET-ID		A	0	–	17046 (4296h)
34094 (852Eh)	34095 (852Fh)	Data transfer (DTF23) target NET-ID		A	0	–	17047 (4297h)
34096 (8530h)	34097 (8531h)	Data transfer (DTF24) target NET-ID		A	0	–	17048 (4298h)
34098 (8532h)	34099 (8533h)	Data transfer (DTF25) target NET-ID		A	0	–	17049 (4299h)
34100 (8534h)	34101 (8535h)	Data transfer (DTF26) target NET-ID		A	0	–	17050 (429Ah)

Modbus communication register address		Name	Description	Update	Initial setting		NET-ID
Upper	Lower				Initial value	Unit	
34102 (8536h)	34103 (8537h)	Data transfer (DTF27) target NET-ID	Sets the NET-ID (data destination) to be transferred in data transfer. [Setting range] 0 to 65,535	A	0	–	17051 (429Bh)
34104 (8538h)	34105 (8539h)	Data transfer (DTF28) target NET-ID		A	0	–	17052 (429Ch)
34106 (853Ah)	34107 (853Bh)	Data transfer (DTF29) target NET-ID		A	0	–	17053 (429Dh)
34108 (853Ch)	34109 (853Dh)	Data transfer (DTF30) target NET-ID		A	0	–	17054 (429Eh)
34110 (853Eh)	34111 (853Fh)	Data transfer (DTF31) target NET-ID		A	0	–	17055 (429Fh)

13-17 General purpose registers

Modbus communication register address		Name	Description	Update	Initial setting		NET-ID
Upper	Lower				Initial value	Unit	
2048 (0800h)	2049 (0801h)	General register 0 default value	Sets the initial value of the general register. [Setting range] –2,147,483,648 to 2,147,483,647	A	0	–	1024 (0400h)
2050 (0802h)	2051 (0803h)	General register 1 default value		A	0	–	1025 (0401h)
2052 (0804h)	2053 (0805h)	General register 2 default value		A	0	–	1026 (0402h)
2054 (0806h)	2055 (0807h)	General register 3 default value		A	0	–	1027 (0403h)
2056 (0808h)	2057 (0809h)	General register 4 default value		A	0	–	1028 (0404h)
2058 (080Ah)	2059 (080Bh)	General register 5 default value		A	0	–	1029 (0405h)
2060 (080Ch)	2061 (080Dh)	General register 6 default value		A	0	–	1030 (0406h)
2062 (080Eh)	2063 (080Fh)	General register 7 default value		A	0	–	1031 (0407h)
2064 (0810h)	2065 (0811h)	General register 8 default value		A	0	–	1032 (0408h)
2066 (0812h)	2067 (0813h)	General register 9 default value		A	0	–	1033 (0409h)
2068 (0814h)	2069 (0815h)	General register 10 default value		A	0	–	1034 (040Ah)
2070 (0816h)	2071 (0817h)	General register 11 default value		A	0	–	1035 (040Bh)
2072 (0818h)	2073 (0819h)	General register 12 default value		A	0	–	1036 (040Ch)
2074 (081Ah)	2075 (081Bh)	General register 13 default value		A	0	–	1037 (040Dh)
2076 (081Ch)	2077 (081Dh)	General register 14 default value		A	0	–	1038 (040Eh)
2078 (081Eh)	2079 (081Fh)	General register 15 default value		A	0	–	1039 (040Fh)

Modbus communication register address		Name	Description	Update	Initial setting		NET-ID
Upper	Lower				Initial value	Unit	
2080 (0820h)	2081 (0821h)	General register 16 default value	Sets the initial value of the general register. [Setting range] -2,147,483,648 to 2,147,483,647	A	0	-	1040 (0410h)
2082 (0822h)	2083 (0823h)	General register 17 default value		A	0	-	1041 (0411h)
2084 (0824h)	2085 (0825h)	General register 18 default value		A	0	-	1042 (0412h)
2086 (0826h)	2087 (0827h)	General register 19 default value		A	0	-	1043 (0413h)
2088 (0828h)	2089 (0829h)	General register 20 default value		A	0	-	1044 (0414h)
2090 (082Ah)	2091 (082Bh)	General register 21 default value		A	0	-	1045 (0415h)
2092 (082Ch)	2093 (082Dh)	General register 22 default value		A	0	-	1046 (0416h)
2094 (082Eh)	2095 (082Fh)	General register 23 default value		A	0	-	1047 (0417h)
2096 (0830h)	2097 (0831h)	General register 24 default value		A	0	-	1048 (0418h)
2098 (0832h)	2099 (0833h)	General register 25 default value		A	0	-	1049 (0419h)
2100 (0834h)	2101 (0835h)	General register 26 default value		A	0	-	1050 (041Ah)
2102 (0836h)	2103 (0837h)	General register 27 default value		A	0	-	1051 (041Bh)
2104 (0838h)	2105 (0839h)	General register 28 default value		A	0	-	1052 (041Ch)
2106 (083Ah)	2107 (083Bh)	General register 29 default value		A	0	-	1053 (041Dh)
2108 (083Ch)	2109 (083Dh)	General register 30 default value	A	0	-	1054 (041Eh)	
2110 (083Eh)	2111 (083Fh)	General register 31 default value	A	0	-	1055 (041Fh)	

13-18 Latch function

Modbus communication register address		Name	Description	Update	Initial setting		NET-ID
Upper	Lower				Initial value	Unit	
4160 (1040h)	4161 (1041h)	LAT-JUMP0 action	Selects the movement of the latch by the low event. [Setting range] 0: 1 shot 1: Continuous	A	0	–	2080 (0820h)
4162 (1042h)	4163 (1043h)	LAT-JUMP1 action	Indicates the movement of the latch by the middle event. [Setting range] 0: 1 shot 1: Continuous	A	0	–	2081 (0821h)
4164 (1044h)	4165 (1045h)	LAT-JUMP2 action	Selects the movement of the latch by the high event. [Setting range] 0: 1 shot 1: Continuous	A	0	–	2082 (0822h)
4166 (1046h)	4167 (1047h)	LAT-NEXT action	Selects the movement of the latch by the NEXT input. [Setting range] 0: 1 shot 1: Continuous	A	0	–	2083 (0823h)
4168 (1048h)	4169 (1049h)	LAT-STOP action	Selects the movement of the latch by the stop input. [Setting range] 0: 1 shot 1: Continuous	A	0	–	2084 (0824h)
4176 (1050h)	4177 (1051h)	USR-LAT0 action	Selects the movement of the latch by USR-LAT0. [Setting range] 0: 1 shot 1: Continuous	A	0	–	2088 (0828h)
4178 (1052h)	4179 (1053h)	USR-LAT1 action	Selects the movement of the latch by USR-LAT1. [Setting range] 0: 1 shot 1: Continuous	A	0	–	2089 (0829h)
4180 (1054h)	4181 (1055h)	USR-LAT0 source	Selects the input source of USR-LAT0. [Setting range] 0: IO for latch (USR-LAT-IN0) 1: Phase Z (ZSG-N)	A	0	–	2090 (082Ah)
4182 (1056h)	4183 (1057h)	USR-LAT1 source	Selects the input source of USR-LAT1. [Setting range] 0: IO for latch (USR-LAT-IN1) 1: Phase Z (ZSG-N)	A	0	–	2091 (082Bh)

13-19 CANopen objects

Modbus communication register address		Name	Description	Update	Initial setting		NET-ID
Upper	Lower				Initial value	Unit	
34320 (8610h)	34321 (8611h)	COB-ID SYNC message-generate	[Setting range] 0: CANopen device does not generate SYNC message 1: CANopen device generates SYNC message	D	0	–	17160 (4308h)
34322 (8612h)	34323 (8613h)	COB-ID SYNC message-11bit CAN-ID	[Setting range] 0001h to 0700h	D	0080h	–	17161 (4309h)
34324 (8614h)	34325 (8615h)	Communication cycle period	[Setting range] 0 to 1,000,000 us	D	0	us	17162 (430Ah)
34328 (8618h)	34329 (8619h)	Guard time	[Setting range] 0 to 65,535 ms	D	0	ms	17164 (430Ch)
34330 (861Ah)	34331 (861Bh)	Life time factor	[Setting range] 0 to 255	D	0	–	17165 (430Dh)
34334 (861Eh)	34335 (861Fh)	COB-ID EMCY-Valid	[Setting range] 0: PDO exists/is valid 1: PDO does not exist/is not valid	D	0	–	17167 (430Fh)
34336 (8620h)	34337 (8621h)	COB-ID EMCY-11bit CAN-ID (000: 80h + Node-ID)	[Setting range] 0000h to 0700h	D	0	–	17168 (4310h)
34340 (8624h)	34341 (8625h)	Consumer heartbeat time-time	[Setting range] 0 to 65,535 ms	D	0	ms	17170 (4312h)
34342 (8626h)	34343 (8627h)	Consumer heartbeat time-NodeID	[Setting range] 0 to 127	D	0	–	17171 (4313h)
34344 (8628h)	34345 (8629h)	Producer heartbeat time	[Setting range] 0 to 65,535 ms	D	0	ms	17172 (4314h)
34368 (8640h)	34369 (8641h)	RPDO1 COB-ID-Valid	[Setting range] 0: PDO exists/is valid 1: PDO does not exist/is not valid	D	0	–	17184 (4320h)
34370 (8642h)	34371 (8643h)	RPDO1 COB-ID-11bit CAN-ID (000: 200h + Node-ID)	[Setting range] 0000h to 0700h	D	0	–	17185 (4321h)
34372 (8644h)	34373 (8645h)	RPDO1 Transmission type	[Setting range] 00h: synchronous (reflected in Sync) FEh: event-driven (relected at receive timing/TPDO1-RTR internal issue/Node life time reset) FFh: event-driven (reflected at receive timing)	D	FFh	–	17186 (4322h)
34382 (864Eh)	34383 (864Fh)	RPDO1 Number of mapped	[Setting range] 0 to 4	D	1	–	17191 (4327h)
34384 (8650h)	34385 (8651h)	RPDO1 1st objects	[Setting range] 0000 0000h to 7FFF FFFFh	D	6040 0010h	–	17192 (4328h)
34386 (8652h)	34387 (8653h)	RPDO1 2nd objects	[Setting range] 0000 0000h to 7FFF FFFFh	D	0	–	17193 (4329h)
34388 (8654h)	34389 (8655h)	RPDO1 3rd objects	[Setting range] 0000 0000h to 7FFF FFFFh	D	0	–	17194 (432Ah)
34390 (8656h)	34391 (8657h)	RPDO1 4th objects	[Setting range] 0000 0000h to 7FFF FFFFh	D	0	–	17195 (432Bh)

Modbus communication register address		Name	Description	Update	Initial setting		NET-ID
Upper	Lower				Initial value	Unit	
34400 (8660h)	34401 (8661h)	RPDO2 COB-ID-Valid	[Setting range] 0: PDO exists/is valid 1: PDO does not exist/is not valid	D	0	–	17200 (4330h)
34402 (8662h)	34403 (8663h)	RPDO2 COB-ID-11bit CAN-ID (000: 300h + Node-ID)	[Setting range] 0000h to 0700h	D	0	–	17201 (4331h)
34404 (8664h)	34405 (8665h)	RPDO2 Transmission type	[Setting range] 00h: synchronous (reflected in Sync) FEh: event-driven (relected at receive timing/TPDO2- RTR internal issue/Node life time reset) FFh: event-driven (reflected at receive timing)	D	FFh	–	17202 (4332h)
34414 (866Eh)	34415 (866Fh)	RPDO2 Number of mapped	[Setting range] 0 to 4	D	2	–	17207 (4337h)
34416 (8670h)	34417 (8671h)	RPDO2 1st objects	[Setting range] 0000 0000h to 7FFF FFFFh	D	6040 0010h	–	17208 (4338h)
34418 (8672h)	34419 (8673h)	RPDO2 2nd objects	[Setting range] 0000 0000h to 7FFF FFFFh	D	6060 0008h	–	17209 (4339h)
34420 (8674h)	34421 (8675h)	RPDO2 3rd objects	[Setting range] 0000 0000h to 7FFF FFFFh	D	0	–	17210 (433Ah)
34422 (8676h)	34423 (8677h)	RPDO2 4th objects	[Setting range] 0000 0000h to 7FFF FFFFh	D	0	–	17211 (433Bh)
34432 (8680h)	34433 (8681h)	RPDO3 COB-ID-Valid	[Setting range] 0: PDO exists/is valid 1: PDO does not exist/is not valid	D	0	–	17216 (4340h)
34434 (8682h)	34435 (8683h)	RPDO3 COB-ID-11bit CAN-ID (000: 400h + Node-ID)	[Setting range] 0000h to 0700h	D	0	–	17217 (4341h)
34436 (8684h)	34437 (8685h)	RPDO3 Transmission type	[Setting range] 00h: synchronous (reflected in Sync) FEh: event-driven (relected at receive timing/TPDO3- RTR internal issue/Node life time reset) FFh: event-driven (reflected at receive timing)	D	FFh	–	17218 (4342h)
34446 (868Eh)	34447 (868Fh)	RPDO3 Number of mapped	[Setting range] 0 to 4	D	2	–	17223 (4347h)
34448 (8690h)	34449 (8691h)	RPDO3 1st objects	[Setting range] 0000 0000h to 7FFF FFFFh	D	6040 0010h	–	17224 (4348h)
34450 (8692h)	34451 (8693h)	RPDO3 2nd objects	[Setting range] 0000 0000h to 7FFF FFFFh	D	607A 0020h	–	17225 (4349h)
34452 (8694h)	34453 (8695h)	RPDO3 3rd objects	[Setting range] 0000 0000h to 7FFF FFFFh	D	0	–	17226 (434Ah)
34454 (8696h)	34455 (8697h)	RPDO3 4th objects	[Setting range] 0000 0000h to 7FFF FFFFh	D	0	–	17227 (434Bh)
34464 (86A0h)	34465 (86A1h)	RPDO4 COB-ID-Valid	[Setting range] 0: PDO exists/is valid 1: PDO does not exist/is not valid	D	0	–	17232 (4350h)
34466 (86A2h)	34467 (86A3h)	RPDO4 COB-ID-11bit CAN-ID (000: 500h + Node-ID)	[Setting range] 0000h to 0700h	D	0	–	17233 (4351h)

Modbus communication register address		Name	Description	Update	Initial setting		NET-ID
Upper	Lower				Initial value	Unit	
34468 (86A4h)	34469 (86A5h)	RPDO4 Transmission type	[Setting range] 00h: synchronous (reflected in Sync) FEh: event-driven (reflected at receive timing/TPDO4-RTR internal issue/Node life time reset) FFh: event-driven (reflected at receive timing)	D	FFh	–	17234 (4352h)
34478 (86AEh)	34479 (86AFh)	RPDO4 Number of mapped	[Setting range] 0 to 4	D	2	–	17239 (4357h)
34480 (86B0h)	34481 (86B1h)	RPDO4 1st objects	[Setting range] 0000 0000h to 7FFF FFFFh	D	6040 0010h	–	17240 (4358h)
34482 (86B2h)	34483 (86B3h)	RPDO4 2nd objects	[Setting range] 0000 0000h to 7FFF FFFFh	D	60FF 0020h	–	17241 (4359h)
34484 (86B4h)	34485 (86B5h)	RPDO4 3rd objects	[Setting range] 0000 0000h to 7FFF FFFFh	D	0	–	17242 (435Ah)
34486 (86B6h)	34487 (86B7h)	RPDO4 4th objects	[Setting range] 0000 0000h to 7FFF FFFFh	D	0	–	17243 (435Bh)
34496 (86C0h)	34497 (86C1h)	TPDO1 COB-ID-Valid	[Setting range] 0: PDO exists/is valid 1: PDO does not exist/is not valid	D	0	–	17248 (4360h)
34498 (86C2h)	34499 (86C3h)	TPDO1 COB-ID-RTR	[Setting range] 0: RTR allowed on this PDO 1: no RTR allowed on this PDO	D	1	–	17249 (4361h)
34500 (86C4h)	34501 (86C5h)	TPDO1 COB-ID-11bit CAN-ID (000: 180h + Node-ID)	[Setting range] 0000h to 0700h	D	0	–	17250 (4362h)
34502 (86C6h)	34503 (86C7h)	TPDO1 Transmission type	[Setting range] 00h: synchronous (acyclic) 01h to F0h: synchronous (cyclic every SYNC) F1h to FBh: reserved FCh: RTR-only (synchronous) FDh: RTR-only (event-driven) FEh to FFh: event-driven (when the value is changed/ when EVENT-TIME is elapsed)	D	FFh	–	17251 (4363h)
34504 (86C8h)	34505 (86C9h)	TPDO1 Inhibit time	[Setting range] 0 to 65,535 (1=100 us)	D	50	100 us	17252 (4364h)
34506 (86CAh)	34507 (86CBh)	TPDO1 Event timer	[Setting range] 0 to 65,535 ms	D	0	ms	17253 (4365h)
34510 (86CEh)	34511 (86CFh)	TPDO1 Number of mapped	[Setting range] 0 to 4	D	1	–	17255 (4367h)
34512 (86D0h)	34513 (86D1h)	TPDO1 1st objects	[Setting range] 0000 0000h to 7FFF FFFFh	D	6041 0010h	–	17256 (4368h)
34514 (86D2h)	34515 (86D3h)	TPDO1 2nd objects	[Setting range] 0000 0000h to 7FFF FFFFh	D	0	–	17257 (4369h)
34516 (86D4h)	34517 (86D5h)	TPDO1 3rd objects	[Setting range] 0000 0000h to 7FFF FFFFh	D	0	–	17258 (436Ah)
34518 (86D6h)	34519 (86D7h)	TPDO1 4th objects	[Setting range] 0000 0000h to 7FFF FFFFh	D	0	–	17259 (436Bh)
34528 (86E0h)	34529 (86E1h)	TPDO2 COB-ID-Valid	[Setting range] 0: PDO exists/is valid 1: PDO does not exist/is not valid	D	0	–	17264 (4370h)

Modbus communication register address		Name	Description	Update	Initial setting		NET-ID
Upper	Lower				Initial value	Unit	
34530 (86E2h)	34531 (86E3h)	TPDO2 COB-ID-RTR	[Setting range] 0: RTR allowed on this PDO 1: no RTR allowed on this PDO	D	1	–	17265 (4371h)
34532 (86E4h)	34533 (86E5h)	TPDO2 COB-ID-11bit CAN-ID (000: 280h + Node-ID)	[Setting range] 0000h to 0700h	D	0	–	17266 (4372h)
34534 (86E6h)	34535 (86E7h)	TPDO2 Transmission type	[Setting range] 00h: synchronous (acyclic) 01h to F0h: synchronous (cyclic every SYNC) F1h to FBh: reserved FCh: RTR-only (synchronous) FDh: RTR-only (event-driven) FEh to FFh: event-driven (when the value is changed/ when EVENT-TIME is elapsed)	D	FFh	–	17267 (4373h)
34536 (86E8h)	34537 (86E9h)	TPDO2 Inhibit time	[Setting range] 0 to 65,535 (1=100 us)	D	50	100 us	17268 (4374h)
34538 (86EAh)	34539 (86EBh)	TPDO2 Event timer	[Setting range] 0 to 65,535 ms	D	0	ms	17269 (4375h)
34542 (86EEh)	34543 (86EFh)	TPDO2 Number of mapped	[Setting range] 0 to 4	D	2	–	17271 (4377h)
34544 (86F0h)	34545 (86F1h)	TPDO2 1st objects	[Setting range] 0000 0000h to 7FFF FFFFh	D	6041 0010h	–	17272 (4378h)
34546 (86F2h)	34547 (86F3h)	TPDO2 2nd objects	[Setting range] 0000 0000h to 7FFF FFFFh	D	6061 0008h	–	17273 (4379h)
34548 (86F4h)	34549 (86F5h)	TPDO2 3rd objects	[Setting range] 0000 0000h to 7FFF FFFFh	D	0	–	17274 (437Ah)
34550 (86F6h)	34551 (86F7h)	TPDO2 4th objects	[Setting range] 0000 0000h to 7FFF FFFFh	D	0	–	17275 (437Bh)
34560 (8700h)	34561 (8701h)	TPDO3 COB-ID-Valid	[Setting range] 0: PDO exists/is valid 1: PDO does not exist/is not valid	D	0	–	17280 (4380h)
34562 (8702h)	34563 (8703h)	TPDO3 COB-ID-RTR	[Setting range] 0: RTR allowed on this PDO 1: no RTR allowed on this PDO	D	1	–	17281 (4381h)
34564 (8704h)	34565 (8705h)	TPDO3 COB-ID-11bit CAN-ID (000: 380h + Node-ID)	[Setting range] 0000h to 0700h	D	0	–	17282 (4382h)
34566 (8706h)	34567 (8707h)	TPDO3 Transmission type	[Setting range] 00h: synchronous (acyclic) 01h to F0h: synchronous (cyclic every SYNC) F1h to FBh: reserved FCh: RTR-only (synchronous) FDh: RTR-only (event-driven) FEh to FFh: event-driven (when the value is changed/ when EVENT-TIME is elapsed)	D	01h	–	17283 (4383h)
34568 (8708h)	34569 (8709h)	TPDO3 Inhibit time	[Setting range] 0 to 65,535 (1=100 us)	D	50	100 us	17284 (4384h)
34570 (870Ah)	34571 (870Bh)	TPDO3 Event timer	[Setting range] 0 to 65,535 ms	D	0	ms	17285 (4385h)
34574 (870Eh)	34575 (870Fh)	TPDO3 Number of mapped	[Setting range] 0 to 4	D	2	–	17287 (4387h)

Modbus communication register address		Name	Description	Update	Initial setting		NET-ID
Upper	Lower				Initial value	Unit	
34576 (8710h)	34577 (8711h)	TPDO3 1st objects	[Setting range] 0000 0000h to 7FFF FFFFh	D	6041 0010h	–	17288 (4388h)
34578 (8712h)	34579 (8713h)	TPDO3 2nd objects	[Setting range] 0000 0000h to 7FFF FFFFh	D	6064 0020h	–	17289 (4389h)
34580 (8714h)	34581 (8715h)	TPDO3 3rd objects	[Setting range] 0000 0000h to 7FFF FFFFh	D	0	–	17290 (438Ah)
34582 (8716h)	34583 (8717h)	TPDO3 4th objects	[Setting range] 0000 0000h to 7FFF FFFFh	D	0	–	17291 (438Bh)
34592 (8720h)	34593 (8721h)	TPDO4 COB-ID-Valid	[Setting range] 0: PDO exists/is valid 1: PDO does not exist/is not valid	D	0	–	17296 (4390h)
34594 (8722h)	34595 (8723h)	TPDO4 COB-ID-RTR	[Setting range] 0: RTR allowed on this PDO 1: no RTR allowed on this PDO	D	1	–	17297 (4391h)
34596 (8724h)	34597 (8725h)	TPDO4 COB-ID-11bit CAN-ID (000: 480h + Node-ID)	[Setting range] 0000h to 0700h	D	0	–	17298 (4392h)
34598 (8726h)	34599 (8727h)	TPDO4 Transmission type	[Setting range] 00h: synchronous (acyclic) 01h to F0h: synchronous (cyclic every SYNC) F1h to FBh: reserved FCh: RTR-only (synchronous) FDh: RTR-only (event-driven) FEh to FFh: event-driven (when the value is changed/ when EVENT-TIME is elapsed)	D	01h	–	17299 (4393h)
34600 (8728h)	34601 (8729h)	TPDO4 Inhibit time	[Setting range] 0 to 65,535 (1=100 us)	D	50	100 us	17300 (4394h)
34602 (872Ah)	34603 (872Bh)	TPDO4 Event timer	[Setting range] 0 to 65,535 ms	D	0	ms	17301 (4395h)
34606 (872Eh)	34607 (872Fh)	TPDO4 Number of mapped	[Setting range] 0 to 4	D	2	–	17303 (4397h)
34608 (8730h)	34609 (8731h)	TPDO4 1st objects	[Setting range] 0000 0000h to 7FFF FFFFh	D	6041 0010h	–	17304 (4398h)
34610 (8732h)	34611 (8733h)	TPDO4 2nd objects	[Setting range] 0000 0000h to 7FFF FFFFh	D	606C 0020h	–	17305 (4399h)
34612 (8734h)	34613 (8735h)	TPDO4 3rd objects	[Setting range] 0000 0000h to 7FFF FFFFh	D	0	–	17306 (439Ah)
34614 (8736h)	34615 (8737h)	TPDO4 4th objects	[Setting range] 0000 0000h to 7FFF FFFFh	D	0	–	17307 (439Bh)
34656 (8760h)	34657 (8761h)	Shutdown option code	[Setting range] 0: Disable drive function 1: Slow down with slow down ramp	A	0	–	17328 (43B0h)
34658 (8762h)	34659 (8763h)	Disable operation option code	[Setting range] 0: Disable drive function 1: Slow down with slow down ramp	A	1	–	17329 (43B1h)
34664 (8768h)	34665 (8769h)	Modes of operation	[Setting range] 0: non 1: Profile position mode 3: Profile velocity mode 6: Homing mode	A	3	–	17332 (43B4h)
34688 (8780h)	34689 (8781h)	Max torque	[Setting range] 0 to 10,000	A	10,000	–	17344 (43C0h)

Modbus communication register address		Name	Description	Update	Initial setting		NET-ID
Upper	Lower				Initial value	Unit	
34704 (8790h)	34705 (8791h)	Profile velocity	[Setting range] 1 to 4,000,000	A	1	–	17352 (43C8h)
34708 (8794h)	34709 (8795h)	Profile acceleration	[Setting range] 1 to 1,000,000,000	A	1,000	–	17354 (43CAh)
34710 (8796h)	34711 (8797h)	Profile deceleration	[Setting range] 1 to 1,000,000,000	A	1,000	–	17355 (43CBh)
34720 (87A0h)	34721 (87A1h)	Homing method	[Setting range] 37: Homing on current position 35: Homing on current position (obsolete) 1: Homing on negative limit switch and index pulse (Dir: –) 2: Homing on positive limit switch and index pulse (Dir: +) 8: Homing on home switch and index pulse (Dir: +) 12: Homing on home switch and index pulse (Dir: –) 17: Homing on negative limit switch without index pulse (Dir: –) 18: Homing on positive limit switch without index pulse (Dir: +) 24: Homing on home switch without index pulse (Dir: +) 28: Homing on home switch without index pulse (Dir: –) –1: Follow (HOME) Homing mode parameter	A	37	–	17360 (43D0h)

14 I/O signals assignment list

14-1 Input signals

To assign signals via industrial network, use the "assignment numbers" in the table instead of the signal names.

Assignment number	Signal name	Assignment number	Signal name	Assignment number	Signal name
0	Not used	52	FW-JOG-P	95	D-SEL15
1	FREE	53	RV-JOG-P	96	R0
2	S-ON	56	FW-POS	97	R1
3	CLR	57	RV-POS	98	R2
4	QSTOP	58	FW-SPD	99	R3
5	STOP	59	RV-SPD	100	R4
7	BREAK-ATSQ	60	FW-PSH	101	R5
8	ALM-RST	61	RV-PSH	102	R6
9	P-PRESET	64	USR-LAT-INO	103	R7
10	EL-PRST	65	USR-LAT-IN1	104	R8
11	USR-ALM	66	FW-BLK	105	R9
12	ETO-CLR	67	RV-BLK	106	R10
13	LAT-CLR	68	FW-LS	107	R11
14	INFO-CLR	69	RV-LS	108	R12
16	HMI	70	HOMES	109	R13
18	TRQ-LMT	71	SLIT	110	R14
19	SPD-LMT	72	ID-SEL0	111	R15
24	PLOOP-MODE	73	ID-SEL1	112	R16
25	ATL-EN	74	ID-SEL2	113	R17
32	START	75	ID-SEL3	114	R18
33	SSTART	80	D-SEL0	115	R19
35	NEXT	81	D-SEL1	116	R20
36	HOME	82	D-SEL2	117	R21
40	M0	83	D-SEL3	118	R22
41	M1	84	D-SEL4	119	R23
42	M2	85	D-SEL5	120	R24
43	M3	86	D-SEL6	121	R25
44	M4	87	D-SEL7	122	R26
45	M5	88	D-SEL8	123	R27
46	M6	89	D-SEL9	124	R28
47	M7	90	D-SEL10	125	R29
48	FW-JOG	91	D-SEL11	126	R30
49	RV-JOG	92	D-SEL12	127	R31
50	FW-JOG-H	93	D-SEL13		
51	RV-JOG-H	94	D-SEL14		

14-2 Output signals

To assign signals via industrial network, use the "assignment numbers" in the table instead of the signal names.

Assignment number	Signal name	Assignment number	Signal name	Assignment number	Signal name
1	FREE_R	66	FW-BLK_R	114	R18_R
2	S-ON_R	67	RV-BLK_R	115	R19_R
3	CLR_R	68	FW-LS_R	116	R20_R
4	QSTOP_R	69	RV-LS_R	117	R21_R
5	STOP_R	70	HOMES_R	118	R22_R
7	BREAK-ATSQ_R	71	SLIT_R	119	R23_R
8	ALM-RST_R	72	ID-SEL0_R	120	R24_R
9	P-PRESET_R	73	ID-SEL1_R	121	R25_R
10	EL-PRST_R	74	ID-SEL2_R	122	R26_R
11	USR-ALM_R	75	ID-SEL3_R	123	R27_R
12	ETO-CLR_R	80	D-SEL0_R	124	R28_R
13	LAT-CLR_R	81	D-SEL1_R	125	R29_R
14	INFO-CLR_R	82	D-SEL2_R	126	R30_R
16	HMI_R	83	D-SEL3_R	127	R31_R
18	TRQ-LMT_R	84	D-SEL4_R	128	CONST-OFF
19	SPD-LMT_R	85	D-SEL5_R	129	ALM-A
24	PLOOP-MODE_R	86	D-SEL6_R	130	ALM-B
25	ATL-EN_R	87	D-SEL7_R	131	SYS-RDY
32	START_R	88	D-SEL8_R	133	SON-MON
33	SSTART_R	89	D-SEL9_R	134	MOVE
35	NEXT_R	90	D-SEL10_R	135	INFO
36	HOME_R	91	D-SEL11_R	136	SYS-BSY
40	M0_R	92	D-SEL12_R	137	ETO-MON
41	M1_R	93	D-SEL13_R	138	IN-POS
42	M2_R	94	D-SEL14_R	140	TLC
43	M3_R	95	D-SEL15_R	141	VA
44	M4_R	96	R0_R	142	ZV
45	M5_R	97	R1_R	145	RDY-HOME-OPE
46	M6_R	98	R2_R	146	RDY-FWRV-OPE
47	M7_R	99	R3_R	147	RDY-SD-OPE
48	FW-JOG_R	100	R4_R	148	RDY-DD-OPE
49	RV-JOG_R	101	R5_R	149	RDY-DPROF-OPE
50	FW-JOG-H_R	102	R6_R	152	OPE-BSY
51	RV-JOG-H_R	103	R7_R	154	SEQ-BSY
52	FW-JOG-P_R	104	R8_R	155	DELAY-BSY
53	RV-JOG-P_R	105	R9_R	159	DDBUF-FULL
56	FW-POS_R	106	R10_R	160	AREA0
57	RV-POS_R	107	R11_R	162	AREA2
58	FW-SPD_R	108	R12_R	163	AREA3
59	RV-SPD_R	109	R13_R	164	AREA4
60	FW-PSH_R	110	R14_R	165	AREA5
61	RV-PSH_R	111	R15_R	166	AREA6
64	USR-LAT-IN0_R	112	R16_R	167	AREA7
65	USR-LAT-IN1_R	113	R17_R	168	WRAP-OVF

Assignment number	Signal name	Assignment number	Signal name	Assignment number	Signal name
169	FW-SLS	221	D-END13	292	INFO-USRIO4
170	RV-SLS	222	D-END14	293	INFO-USRIO5
171	ZSG-N	223	D-END15	294	INFO-USRIO6
172	WRAP-ZERO	224	TRQ-LMTD	295	INFO-USRIO7
175	MAREA	225	SPD-LMTD	296	INFO-POS-ERR
176	HOME-END	228	OL-DTCT	300	INFO-SPD-H
177	ABSPEN	232	USR-OUT0	301	INFO-SPD-L
178	ELPRST-MON	233	USR-OUT1	302	INFO-SPD-ERR
184	USR-LAT0	234	USR-OUT2	304	INFO-TLC-TIME
185	USR-LAT1	235	USR-OUT3	306	INFO-CULD0
186	JUMP0-LAT	236	USR-OUT4	307	INFO-CULD1
187	JUMP1-LAT	237	USR-OUT5	311	INFO-STLTIME
188	JUMP2-LAT	238	USR-OUT6	320	INFO-WH-BOOT
189	NEXT-LAT	239	USR-OUT7	321	INFO-WH-USR
190	STOP-LAT	240	MAIN-PWR	322	INFO-WH-TOTAL
192	PLOOP-MON	241	COMM-PWR	326	INFO-MP-FWCRNT
193	SLIP	244	MBC	327	INFO-MP-RVCRNT
194	ATL-MON	252	EDM-MON	328	INFO-TRIP0
199	M-CHG	253	HWTOIN-MON	329	INFO-TRIP1
200	M-ACT0	256	INFO-USRIO-G	330	INFO-ODO
201	M-ACT1	257	INFO-START-G	332	INFO-CPU-LOAD
202	M-ACT2	258	INFO-485-G	333	INFO-PTIME
203	M-ACT3	262	INFO-MNT-G	334	INFO-PCOUNT
204	M-ACT4	263	INFO-SET-G	336	INFO-485-ERR
205	M-ACT5	264	INFO-DRVTMP	337	INFO-485-PRCST
206	M-ACT6	265	INFO-MTRTMP	338	INFO-485-INTVL
207	M-ACT7	266	INFO-LOAD	344	INFO-CAN-WNG
208	D-END0	267	INFO-TRQ	353	INFO-START-HOME
209	D-END1	268	INFO-WATT	354	INFO-START-FWRV
210	D-END2	272	INFO-VOLT-H	355	INFO-START-SD
211	D-END3	273	INFO-VOLT-L	356	INFO-START-DD
212	D-END4	283	INFO-PRESET	357	INFO-START-DP
213	D-END5	284	INFO-DSLMTD	359	INFO-IODRV-DIS
214	D-END6	285	INFO-IOTEST	360	INFO-FW-OT
215	D-END7	286	INFO-CONFIG	361	INFO-RV-OT
216	D-END8	287	INFO-REBOOT	368	INFO-UNIT-E
217	D-END9	288	INFO-USRIO0	369	INFO-SOFTLMT-E
218	D-END10	289	INFO-USRIO1	376	INFO-CPU-FAULT
219	D-END11	290	INFO-USRIO2	377	INFO-OC-FAULT
220	D-END12	291	INFO-USRIO3	378	INFO-ENC-FAULT

7 Alarms and Information

This part explains alarm and information functions. It also describes functions useful for maintenance of equipment.

◆ Table of contents

1	Alarms	428
1-1	Alarm reset	428
1-2	Alarm history	428
1-3	Generation conditions of alarms	429
1-4	Alarms list	432
1-5	Timing chart	444
2	Information	448
2-1	Information output	448
2-2	Clearing information	450
2-3	Information history	450
2-4	Information list	451
2-5	Information status	461
2-6	LED indication for information	461



1 Alarms

This driver has the alarm function to protect from temperature rise, poor connection, error in operation, and others. If an alarm is generated, the ALM-A output is turned ON and the ALM-B output is turned OFF to stop the motor. At the same time, the PWR/SYS LED blinks in red.

The present alarm can be checked by counting the number of times the LED blinks, using the support software, or via communication.

1-1 Alarm reset

Before resetting an alarm, always remove the cause of the alarm and ensure safety, and perform one of the reset operations specified below.

(Timing chart ⇒ p.444)

- Turn the ALM-RST input ON. (The alarm will be reset at the ON edge of the input.)
- Execute the alarm reset via communication.
- Execute the alarm reset using the support software.
- Turn off the power supply and on it again.



Some alarms cannot be reset with the ALM-RST input, the support software, or communication. Check with "1-4 Alarms list" on p.432. To reset these alarms, turn off the power supply and turn on it again.

1-2 Alarm history

Up to 16 generated alarm items are stored in the non-volatile memory in order of the latest to oldest. The alarm history stored in the non-volatile memory can be read or cleared if one of the following is performed.

- Read the alarm history with the monitor command via communication.
- Clear the alarm history with the maintenance command via communication.
- Read and clear the alarm history using the support software.

1-3 Generation conditions of alarms

In the case of alarms shown in the table, an alarm will be generated if the generation condition is exceeded.

Alarm code	Alarm name	Generation condition	
		200 W or less	400 W
10h	Position deviation (rev)	300	
21h	Main circuit overhear (°C)	85	
22h	Overvoltage (V)	63	
25h	Undervoltage (V)	14	29
26h	Motor overhear (°C)	95	
31h	Overspeed	Figure below	

■ Overspeed alarm

The condition in which the overspeed alarm is generated varies depending on the motor excitation state and the main power supply input voltage.

● 60 W type motor

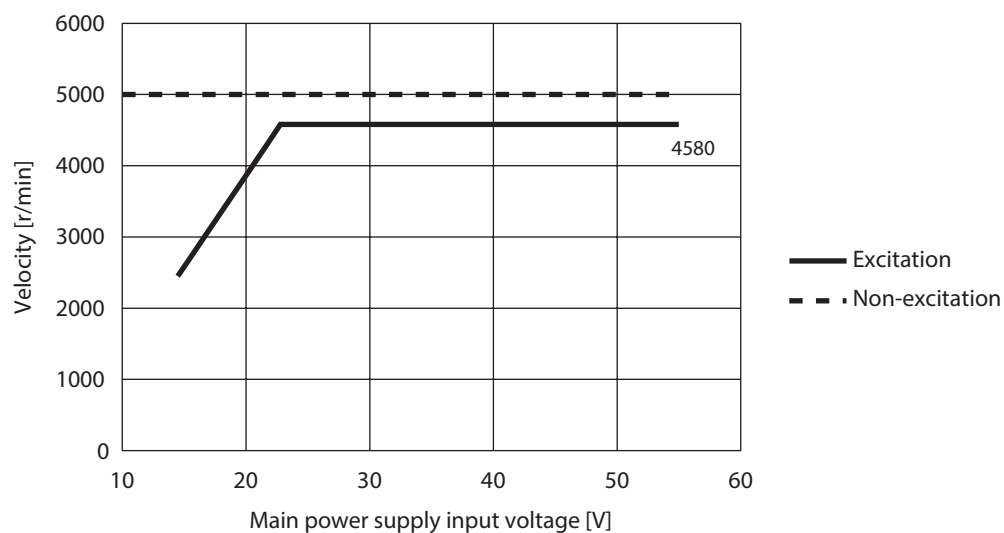

● 100 W type motor

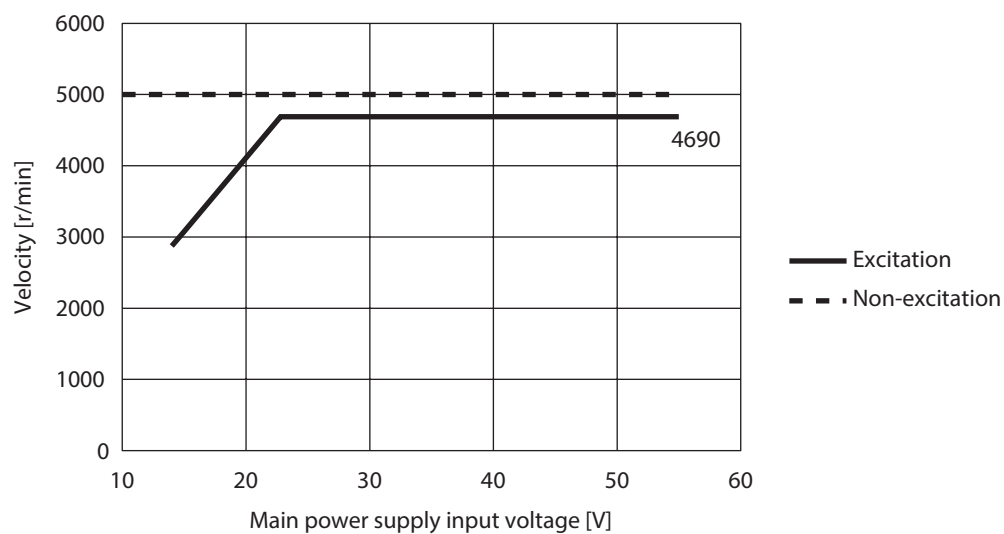

● 200 W type motor

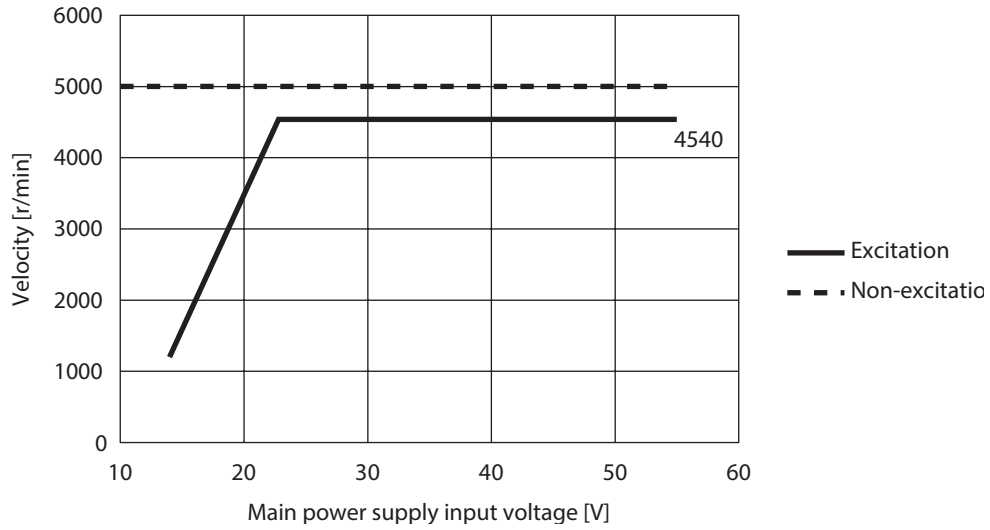

● 400 W type motor

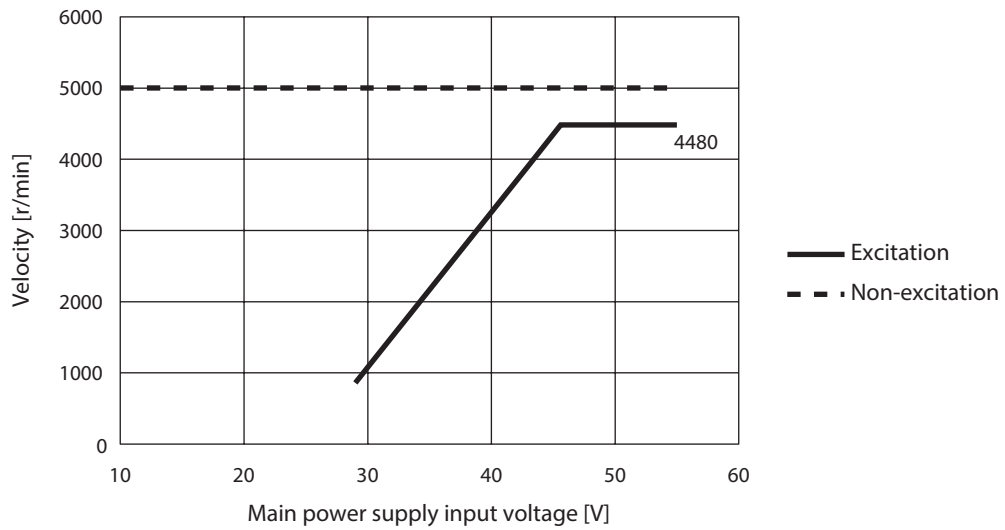

Overvoltage alarm

Setting the following parameters can change the condition in which the overvoltage alarm is generated.
Set according to the equipment used.

- Overvoltage alarm (user setting)
- Overvoltage alarm (main power supply voltage differential conditions)

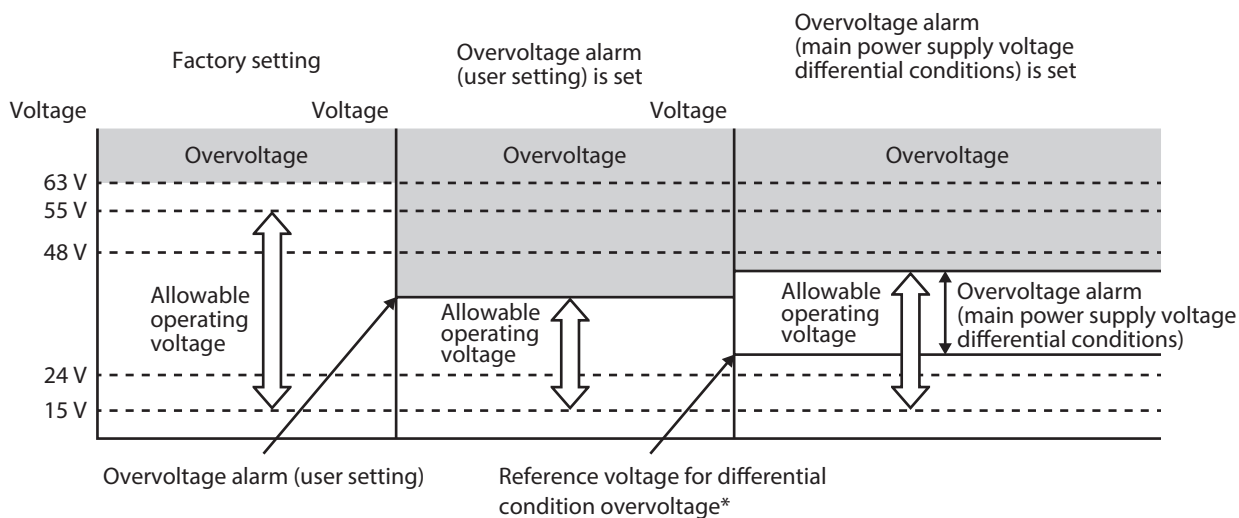

* It is the main power supply voltage when the main power supply is supplied to the driver.



- If a value exceeding 63 V is set, the overvoltage alarm is generated at 63 V.
- When both the overvoltage alarm (user setting) and the overvoltage alarm (main power supply voltage differential conditions) are set, the overvoltage alarm is generated at the lower voltage.

1-4 Alarms list

Alarm code	Number of LED blinks	Alarm type	Cause	Remedial action	Reset by the ALM-RST input	Motor excitation *1
10h	7	Position deviation	<ul style="list-style-type: none"> When the motor was in an excitation state, the deviation between the demand position and the actual position exceeded the value set in the "Position deviation alarm" parameter in the motor shaft. A load is large or the acceleration/deceleration time is too short against the load. The operating range of positioning push-motion SD operation was exceeded. 	<ul style="list-style-type: none"> Decrease the load. Set the acceleration/deceleration time longer. Reconsider the torque limiting value. 	Possible	Non-excitation after deceleration
20h	9	Overcurrent	The motor, the cable, and the driver output circuit were short-circuited.	Turn off the power supply, and check the motor, cable, and driver are not damaged before turning on the power again. If the alarm has still not reset, the motor, cable, or driver may be damaged. Contact your nearest Oriental Motor sales office.	Not possible	Non-excitation
21h	7	Main circuit overheat	The internal temperature of the driver reached the upper limit of the specification value.	Re-examine the ventilation condition.	Possible	Non-excitation after deceleration
22h	5	Overvoltage	<ul style="list-style-type: none"> The main power supply voltage exceeded the permissible value. A large load inertia was suddenly stopped. Vertical operation (elevating operation) was performed. The value set in the "Overvoltage alarm (user setting)" parameter was exceeded. The value set in the "Overvoltage alarm (main power supply voltage differential conditions)" parameter was exceeded. 	<ul style="list-style-type: none"> Check the input voltage of the main power supply. Decrease the load. Set the acceleration/deceleration time longer. Check the value set in the "Overvoltage alarm (user setting)" parameter. Check the value set in the "Overvoltage alarm (main power supply voltage differential conditions)" parameter. 	Possible	Non-excitation
25h	5	Undervoltage	The main power supply was shut off momentarily or the voltage became low.	Check the input voltage of the main power supply.	Possible	Non-excitation after deceleration
26h	7	Motor overheat	The detection temperature of the motor reached the upper limit of the specification value.	<ul style="list-style-type: none"> Check the heat radiation condition of the motor. Reconsider the ventilation condition. 	Possible	Non-excitation after deceleration

Alarm code	Number of LED blinks	Alarm type	Cause	Remedial action	Reset by the ALM-RST input	Motor excitation *1
28h	2	Encoder error	An error of the encoder was detected during operation.	Turn off the power supply, and check the connection of the encoder before turning on the power again.	Not possible	Non-excitation
29h	9	Internal circuit error	The CPU peripheral circuit is damaged.	Contact your nearest Oriental Motor sales office.	Not possible	Non-excitation
2Ah	2	Encoder communication error	An error occurred in communication between the driver and the encoder.	Turn off the power supply, and check the connection of the encoder before turning on the power again.	Not possible	Non-excitation
2Dh	2	Motor connection error *2	The motor and the driver are not connected properly.	Turn off the power supply, and check the connection between the motor and the driver before turning on the power supply again.	Not possible	Non-excitation
30h	7	Overload	A load exceeding the rated torque was applied for more than the specified time. Refer to p.442 for the specified time.	<ul style="list-style-type: none"> • Decrease the load. • Reconsider operating conditions such as the acceleration time and deceleration time. • If the alarm is generated at a low temperature, warm up. • Check if the motor power line is disconnected. 	Possible	Non-excitation after deceleration
31h	7	Overspeed	The actual velocity of the motor shaft exceeded the specification value.	<ul style="list-style-type: none"> • Decrease the load. • Reconsider operating conditions such as the acceleration time and deceleration time. 	Possible	Non-excitation
41h	9	EEPROM error	The data stored in the driver was damaged.	Initialize all parameters, and then turn on the main power supply again. If the alarm has still not reset, the driver may be damaged. Contact your nearest Oriental Motor sales office.	Not possible	Non-excitation
42h	2	Initial encoder error	An error of the encoder was detected when the main power supply was turned on.	Turn off the power supply, and check the connection of the encoder before turning on the power again.	Not possible	Non-excitation
44h	9	Encoder EEPROM error	The data stored in the encoder was damaged.	Turn off the power supply, and check the motor, cable, and driver are not damaged before turning on the power again. If the alarm has still not reset, the motor may be damaged. Contact your nearest Oriental Motor sales office.	Not possible	Non-excitation
45h	2	Motor combination error	A motor not allowed to combine with the driver was connected.	Check the motor model name and driver model name, and connect them in the correct combination.	Not possible	Non-excitation

Alarm code	Number of LED blinks	Alarm type	Cause	Remedial action	Reset by the ALM-RST input	Motor excitation *1
4Ah	7	Homing incomplete	Absolute positioning operation was started in a state where the coordinates had not been set.	Execute the position preset or homing operation.	Possible	Excitation
50h	9	Electromagnetic brake overcurrent	The motor, the cable, and the driver output circuit were short-circuited.	Turn off the power supply, and check the motor, cable, and driver are not damaged before turning on the power again. If the alarm has still not reset, the motor, cable, or driver may be damaged. Contact your nearest Oriental Motor sales office.	Not possible	Non-excitation
53h	3	HWTO input circuit error	<ul style="list-style-type: none"> The allowable time from when one of the HWTO input is turned OFF until when the other is turned OFF exceeded the value set in the "HWTO delay time of checking dual system" parameter. An error of the circuit corresponding to the phenomenon above was detected. 	<ul style="list-style-type: none"> Check the wiring of the HWTO input. Increase the value set in the "HWTO delay time of checking dual system" parameter. 	Not possible	Non-excitation
55h	2	Electromagnetic brake connection error	The electromagnetic brake is not connected properly.	Turn off the power supply, and check the connection of the electromagnetic brake before turning on the power again.	Not possible	Non-excitation
60h	3	±LS both sides active	Both the FW-LS input and the RV-LS input were detected.	Check the sensor logic installed and the "Inverting mode" parameter.	Possible	Excitation
61h	3	Reverse ±LS connection	The LS input opposite to the operating direction was detected while homing operation in 2-sensor mode or 3-sensor mode was performed.	Check the wiring of the sensor.	Possible	Excitation

Alarm code	Number of LED blinks	Alarm type	Cause	Remedial action	Reset by the ALM-RST input	Motor excitation *1
62h	4	Homing operation error	<ul style="list-style-type: none"> • An unanticipated load was applied while homing operation was performed. • The installation positions of the FW-LS and RV-LS sensors and the HOME sensor are near to each other. • Homing operation was executed in a state where both the FW-LS input and the RV-LS input were detected. • Position preset processing upon completion of homing operation was failed. • In homing operation in one-way rotation mode, the HOME sensor was exceeded while the motor decelerated to a stop. 	<ul style="list-style-type: none"> • Check the load. • Reconsider the sensor installation positions and the starting direction of motor operation. • Check the sensor logic installed and the "Inverting mode" parameter. • See that a load exceeding the maximum torque is not applied upon completion of homing operation. • Reconsider the specification of the HOME sensor and the "(HOME) Acceleration/deceleration" parameter. 	Possible	Excitation
63h	4	No HOMES	The HOMES input was not detected at a position between the FW-LS input and the RV-LS input while homing operation in 3-sensor mode was performed.	Install the HOME sensor at a position between the FW-LS and RV-LS sensors.	Possible	Excitation
64h	4	Z, SLIT signal error	The ZSG output and the SLIT input could not be detected during homing operation.	<ul style="list-style-type: none"> • Reconsider the connection status of the load and the position of the HOME sensor so that these signals should be ON while the HOMES input is ON. • When a signal is not used, set the "(HOME) ZSG signal detection" parameter or the "(HOME) SLIT detection" parameter to "Disable." 	Possible	Excitation
66h	4	Hardware overtravel	When the "FW-LS/RV-LS input action" parameter is set to "Immediate stop with alarm," "Deceleration stop with alarm," "Follow QSTOP setting with alarm," or "Follow STOP setting with alarm," the FW-LS input or the RV-LS input was detected.	Reset the alarm and then escape from the sensor by operating the motor or manually.	Possible	Excitation
67h	6	Software overtravel	When the "Software overtravel" parameter is set to "Immediate stop with alarm," "Deceleration stop with alarm," "Follow QSTOP setting with alarm," or "Follow STOP setting with alarm," the demand position reached the software limit.	<ul style="list-style-type: none"> • Reconsider the operation data. • Reset the alarm and then escape from the sensor by operating the motor or manually. 	Possible	Excitation

Alarm code	Number of LED blinks	Alarm type	Cause	Remedial action	Reset by the ALM-RST input	Motor excitation *1
68h	1	HWTO input detection	When the "Occur alarm at HWTO input OFF" parameter is set to "Enable," the HWTO1 input or the HWTO2 input was turned OFF.	Turn both the HWTO1 and HWTO2 inputs ON.	Possible	Non-excitation
6Ah	6	Homing additional operation error	The FW-LS input or the RV-LS input was detected while homing additional operation was performed.	Check the value set in the "(HOME) Travel amount of additional operation after homing" parameter.	Possible	Excitation
6Eh	1	User alarm *2	The USR-ALM input is turned on.	Turn the USR-ALM input OFF.	Possible	Non-excitation after deceleration *3
70h	6	Operation data error	<ul style="list-style-type: none"> • The motor was operated with the travel amount exceeding the specification value. • The motor was operated with the torque limiting value exceeding the specification value. • When the "WRAP setting" parameter is set to "32-bit range," operation using the WRAP function was executed. 	Check the operation data. (Sub code of operation data error ⇒p.440)	Possible	Excitation
71h	6	Unit setting error	<ul style="list-style-type: none"> • The control resolution exceeding the specification value was set. • The velocity unit exceeding the specification value was set. 	<ul style="list-style-type: none"> • Reconsider the setting of the user-defined position unit. • Reconsider the setting of the user-defined velocity unit. 	Not possible	Non-excitation
81h	8	Network bus error	<ul style="list-style-type: none"> • A CANopen error occurred. • When the "Communication power supply lost action" parameter is set to "Immediate stop with alarm," "Deceleration stop with alarm," "Follow QSTOP setting with alarm," or "Follow STOP setting with alarm," OFF (OFF edge) of the power supply for communication was detected. 	<ul style="list-style-type: none"> • Check for an appropriate error in CANopen. • Check if the power supply for communication is supplied properly. (Sub code of network bus error ⇒p.440) 	Possible	Excitation
84h	8	RS-485 communication error	The number of consecutive Modbus communication errors reached the value set in the "Communication error detection (Modbus)" parameter.	<ul style="list-style-type: none"> • Check the connection between the driver and the host controller. • Check the setting of RS-485 communication. • Check if the power supply for communication is supplied properly. 	Possible	Excitation

Alarm code	Number of LED blinks	Alarm type	Cause	Remedial action	Reset by the ALM-RST input	Motor excitation *1
85h	8	RS-485 communication timeout	<ul style="list-style-type: none"> The time set in the "Communication timeout (Modbus)" parameter has elapsed, and yet the communication could not be established with the host controller. The direct data operation lifetime was activated. *2 	<ul style="list-style-type: none"> Check the connection between the driver and the host controller. Check if the power supply for communication is supplied properly. 	Possible	Excitation
8Ch	8	Out of setting range	A parameter out of specification was detected in the CAN parameter when the power supply was turned on or communication was reset.	Set the parameter value in the range of the specification. (Sub code of out of setting range ⇒p.441)	Not possible	Non-excitation
F0h	Lighting	CPU error	CPU malfunctioned.	Turn on the power again.	Not possible	Non-excitation
F3h	6	CPU overload	A load of CPU was exceeded the permissible value.	<ul style="list-style-type: none"> Reconsider the extended function used. Reconsider the number of registrations of PDO. 	Not possible	Non-excitation

*1 An excitation state of the motor when an alarm is generated is as follows.

Non-excitation: If an alarm is generated, the motor current is cut off and the motor holding force is lost.

When an electromagnetic brake motor is used, the electromagnetic brake automatically actuates to hold the motor shaft.

Non-excitation after deceleration: If an alarm is generated, the motor will decelerates to a stop.

After decelerating to a stop, the motor current is cut off and the motor holding force is lost. When an electromagnetic brake motor is used, the electromagnetic brake automatically actuates to hold the motor shaft.

Excitation: If an alarm is generated, the motor will decelerates to a stop.

After decelerating to a stop, the motor current is not shut off and the motor excitation state is continued.

*2 It is effective for the driver version 3.00 or later.

*3 This is the initial setting. The excitation state after the motor stops can be set with the "User alarm action" parameter.



If a 400 W motor or a geared motor is connected to a driver older than the version 3.00, an alarm of "Motor combination error" will be generated.

■ Related parameters

Parameter name	Description	Initial setting	
		Initial value	Unit
Position deviation alarm (user setting)	Sets the condition in which the position deviation alarm is generated. * [Setting range] 0 to 10,000,000 (User-defined position unit)	108,000	step
Stopping method at alarm generation	Sets how to stop the motor when an alarm which motor excitation state is "Excitation" or "Non-excitation after deceleration" is generated. [Setting range] 0: Immediate Stop 1: Deceleration stop (according to the operation profile during operation) 2: Follow QSTOP setting (the excitation state is according to the alarm specifications)	2	–
Stopping timeout at alarm generation	Sets the time-out period from when the alarm of "Non-excitation after deceleration" is generated until the excitation is turned off. [Setting range] 0 to 10,000 ms	3,000	ms
Overvoltage alarm (user setting)	Sets the condition in which the overvoltage alarm is generated. * [Setting range] 0: Disable 1 to 720 (1 = 0.1 V)	0	1=0.1V
Overvoltage alarm (main power supply voltage differential conditions)	Sets the condition in which the overvoltage alarm is generated. * [Setting range] 0: Disable 1 to 450 (1=0.1 V)	0	1=0.1V
User alarm action *2	Sets whether or not to excite the motor after stop when the user alarm is generated. [Setting range] 0: Non-excitation after deceleration 1: Excitation	0	–

*1 If a value larger than the "Generation conditions of alarms" of page 429 is set, an alarm is generated base on the "Generation conditions of alarms."

*2 It is effective for the driver version 3.00 or later.

■ Items that can be checked in the alarm history

Item	Description
Code	This is an alarm code.
Alarm message	This is the description of the alarm.
Sub code	This is our code for checking. However, when the operation data error (alarm code 70h) or the network bus error (alarm code 81h) occurs, the cause of the alarm can be checked by a customer if the sub code is used. (Refer to the next section.)
Driver temperature	This is the driver temperature when an alarm is generated.
Motor temperature	This is the motor temperature when an alarm is generated.
Inverter voltage	This is the inverter voltage when an alarm was generated.
Main power supply voltage	This is the main power supply voltage when an alarm was generated.
Main power supply current	This is the main power supply current when an alarm is generated.
Physical I/O input	Indicates the input status of the direct I/O when an alarm was generated in hexadecimal.
R-I/O input	Indicates the input status of the remote I/O when an alarm was generated in hexadecimal.
R-I/O output	Indicates the output status of the remote I/O when an alarm was generated in hexadecimal.
Continuous uptime	This is the time period from when the main power supply was turned on until an alarm was generated.
Continuous operating time	This is the elapsed time from when operation was started until an alarm was generated.
Total operating time (within continuous uptime)	This is the total (cumulative) operating time since the main power supply was turned on first time until an alarm was generated.
Total uptime	This is the total (cumulative) uptime since the main power supply was turned on first time until an alarm was generated.
Number of boots	This is the number of boots when an alarm was generated.
Actual position	This is the actual position when an alarm was generated.
Demand velocity	This is the demand velocity when an alarm was generated.
Torque	This is the torque when an alarm was generated.
Torque limiting value	This is the torque limiting value when an alarm was generated.
Motor model	This is the motor model when an alarm was generated.
Motor serial number	This is the motor serial number connected when an alarm was generated.



If an alarm is generated immediately after the main power is turned on, the detected information such as temperature may be indefinite.

● **Sub code of operation data error (alarm code 70h)**

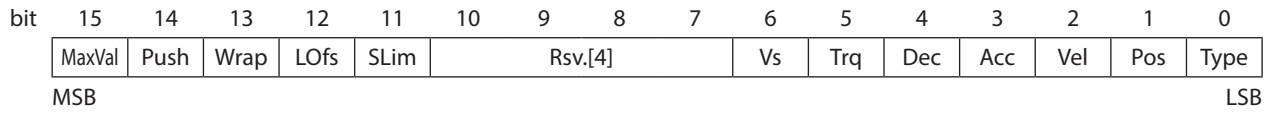
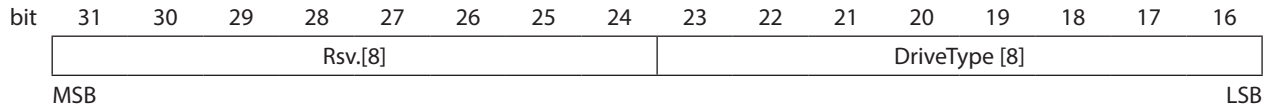

bit	Code	Description
24 to 31	Rsv.	This is a reserved function. The value is indefinite.
16 to 23	DriveType	Indicates the operation type when an alarm was generated.
15	MaxVal	Operation was executed with the operation profile exceeding the specification value.
14	Push	The torque limiting value was exceeded the specification value when push-motion operation was executed.
13	Wrap	When the "WRAP setting" parameter is set to "32-bit range," operation using the WRAP function was executed.
12	LOfs	The offset value of the loop was exceeded the specification value.
11	SLim	Positioning operation that the target position exceeded the software limit was executed.
7 to 10	Rsv.	This is a reserved function. The value is indefinite.
6	Vs	Operation was executed at the starting velocity exceeding the specification value.
5	Trq	Operation was executed with the torque limiting value exceeding the specification value.
4	Dec	Operation was executed with the deceleration rate exceeding the specification value.
3	Acc	Operation was executed with the acceleration rate exceeding the specification value.
2	Vel	Operation was executed at the operating velocity exceeding the specification value.
1	Pos	Operation was executed with the positioning travel amount exceeding the specification value.
0	Type	Operation was executed with the operation type out of the specification.

● **Sub code of network bus error (alarm code 81h)**

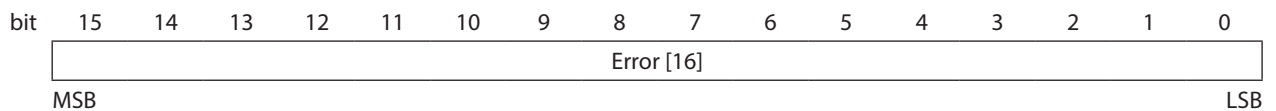
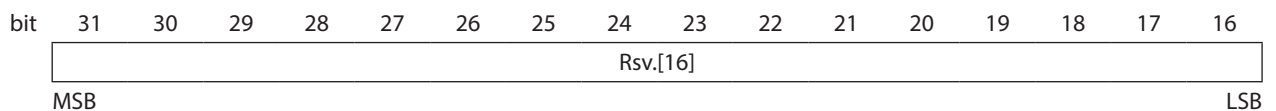

bit	Code	Description
16 to 31	Rsv.	This is a reserved function. The value is indefinite.
0 to 15	Error	Indicates the description of the error. 0000h: Communication power loss 0002h: Abort connection 8110h: CAN overrun 8120h: Passive error mode 8130h: Node guarding error 8140h: Recovery from bus off 8210h: PDO length error

- Sub code of out of setting range (alarm code 8Ch)

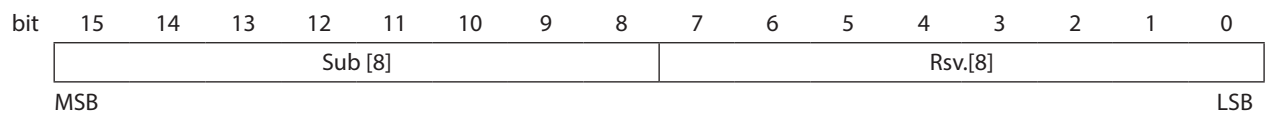
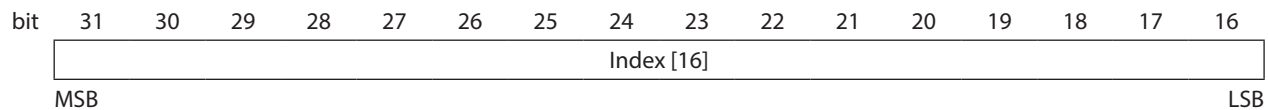

bit	Code	Description
16 to 31	Index	Indicates the Index of the CANopen Object that was out of range.
8 to 15	Sub	Indicates the Sub-index of the CANopen Object that was out of range.
0 to 7	Rsv.	This is a reserved function. The value is indefinite.

■ **Characteristics of overload alarm**

The time when the overload alarm is detected varies according to the load factor of the motor.
Refer to p.477 for a load factor.

● **60 W type motor**

Overload detection time (reference)

Load factor	Overload detection time (reference)
100%	Not detected
117%	About 53 seconds
140%	About 16 seconds
160%	About 10 seconds
180%	About 7 seconds
200%	About 5 seconds

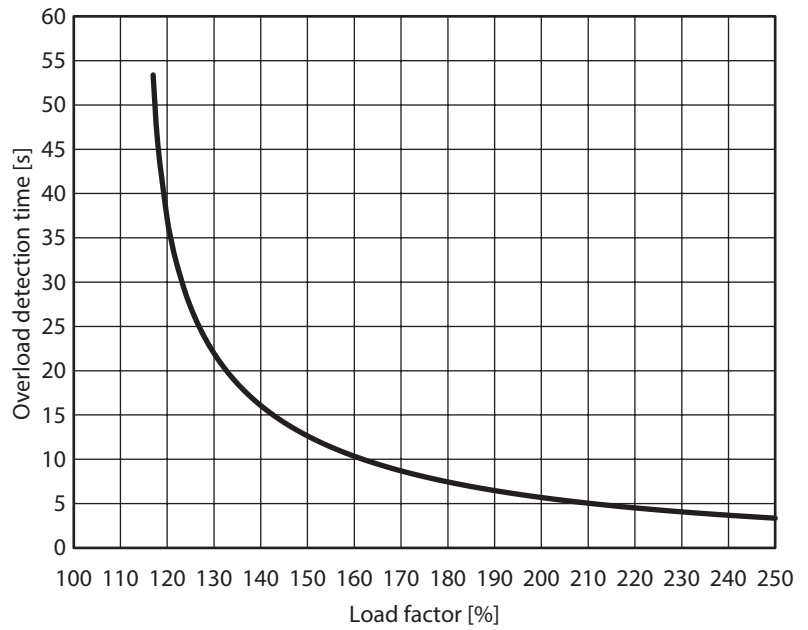

● **100 W type motor**

Overload detection time (reference)

Load factor	Overload detection time (reference)
100%	Not detected
121%	About 57 seconds
140%	About 18 seconds
160%	About 11 seconds
180%	About 8 seconds
200%	About 6 seconds

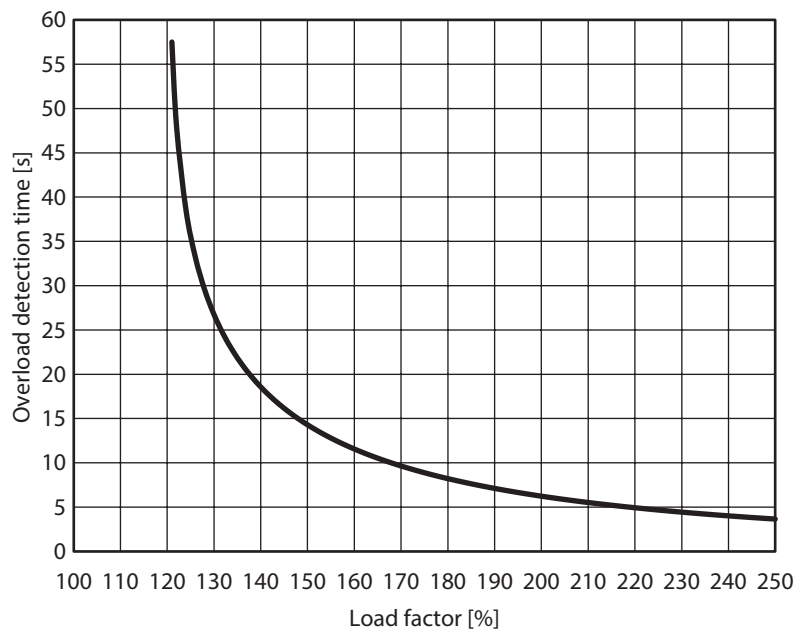

● 200 W type motor

Overload detection time (reference)

Load factor	Overload detection time (reference)
100%	Not detected
111%	About 11 seconds
130%	About 3.5 seconds
150%	About 2.1 seconds
170%	About 1.5 seconds
200%	About 1.0 seconds

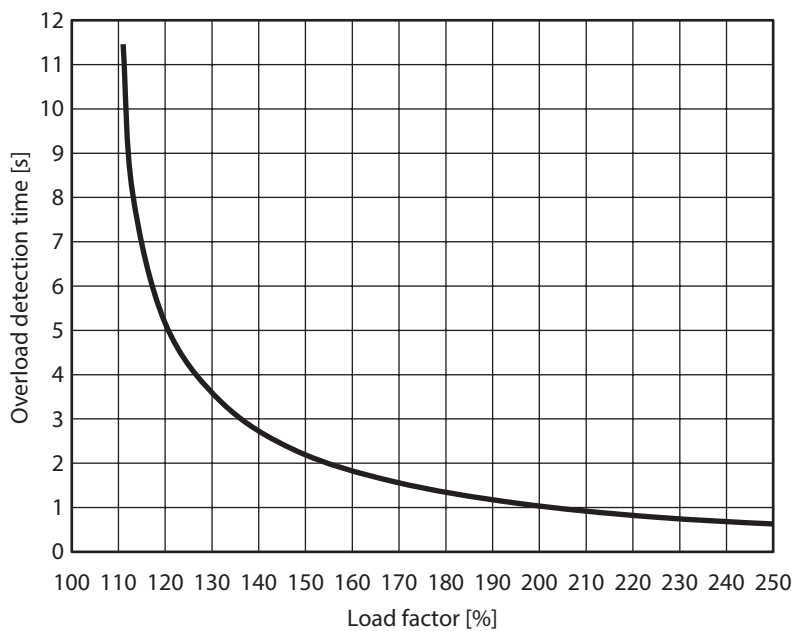

● 400 W type motor

Overload detection time (reference)

Load factor	Overload detection time (reference)
100%	Not detected
108%	About 12 seconds
130%	About 3.2 seconds
150%	About 2.0 seconds
170%	About 1.4 seconds
200%	About 0.9 seconds

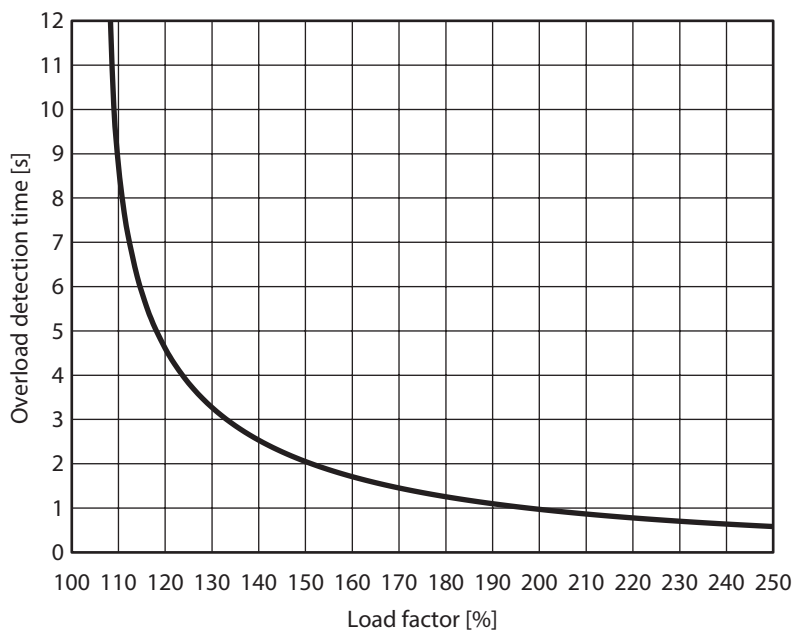

1-5 Timing chart

■ When an alarm which motor excitation state is "Excitation" is generated.

1. If an error occurs, the ALM-B output and the RDY-DD-OPE output are turned OFF.
At the same time, the motor stops according to the value set in the "Stopping method alarm generation" parameter.
Some alarms will stop the motor according to the "FW-LS/RV-LS input action" parameter, "Software overtravel action" parameter, or "Communication power supply lost action" parameter.
2. Remove the cause of the alarm and then turn the ALM-RST input ON.
The alarm is reset, and the ALM-B output and the RDY-DD-OPE output are turned ON.
3. Check the ALM-B output has been turned ON and then turn the ALM-RST input OFF.

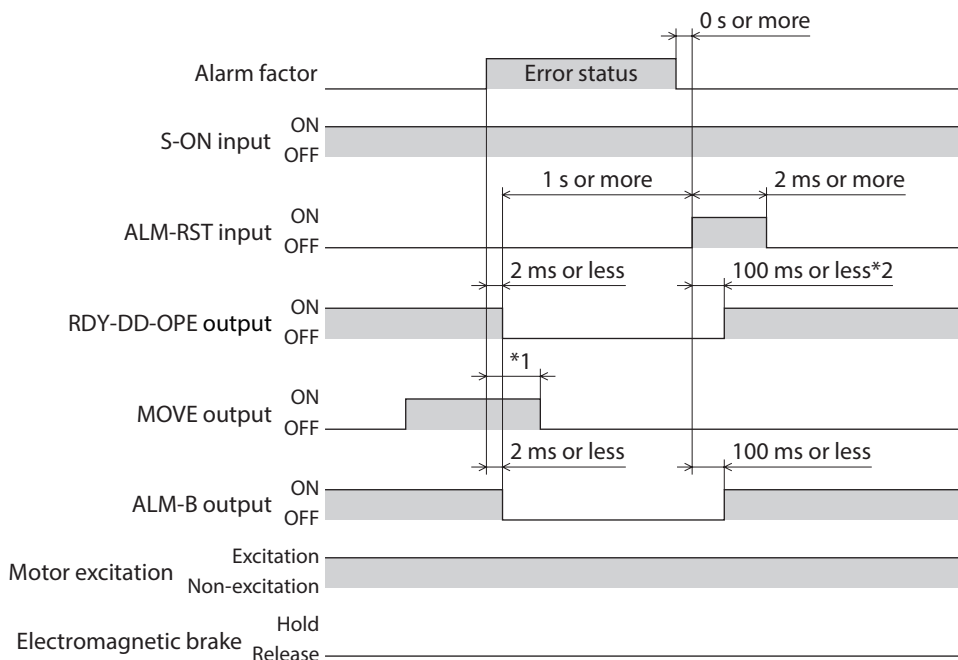
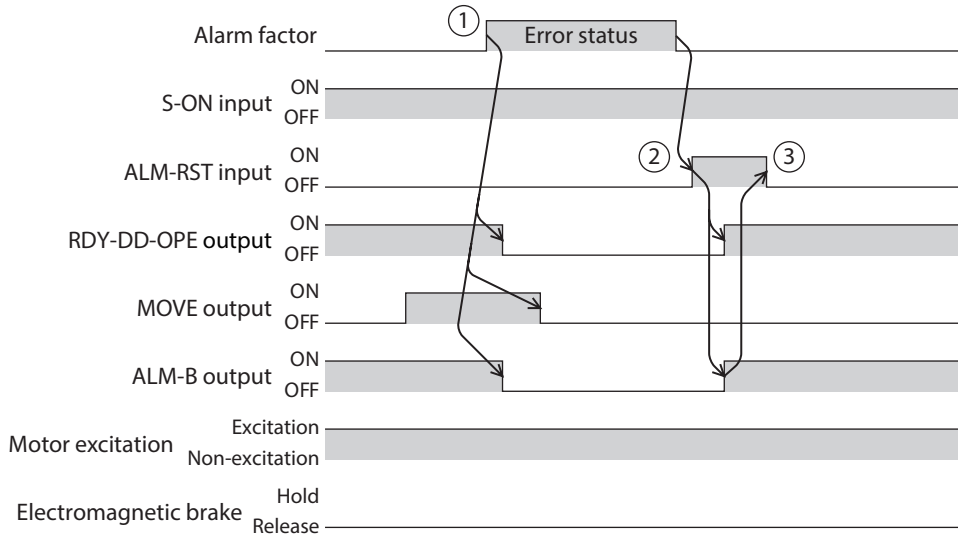

*1 It varies depending on the driving condition.

*2 It is when the MOVE input is being OFF.

■ When an alarm which motor excitation state is "Non-excitation" is generated.

1. If an error occurs, the ALM-B output, the MOVE output, and the RDY-DD-OPE output are turned OFF. At the same time, the motor puts into a non-excitation state.
2. Remove the cause of the alarm and then turn the ALM-RST input ON. The alarm is reset, and the ALM-B output and the RDY-DD-OPE output are turned ON.
3. Check the ALM-B output has been turned ON and then turn the ALM-RST input OFF.

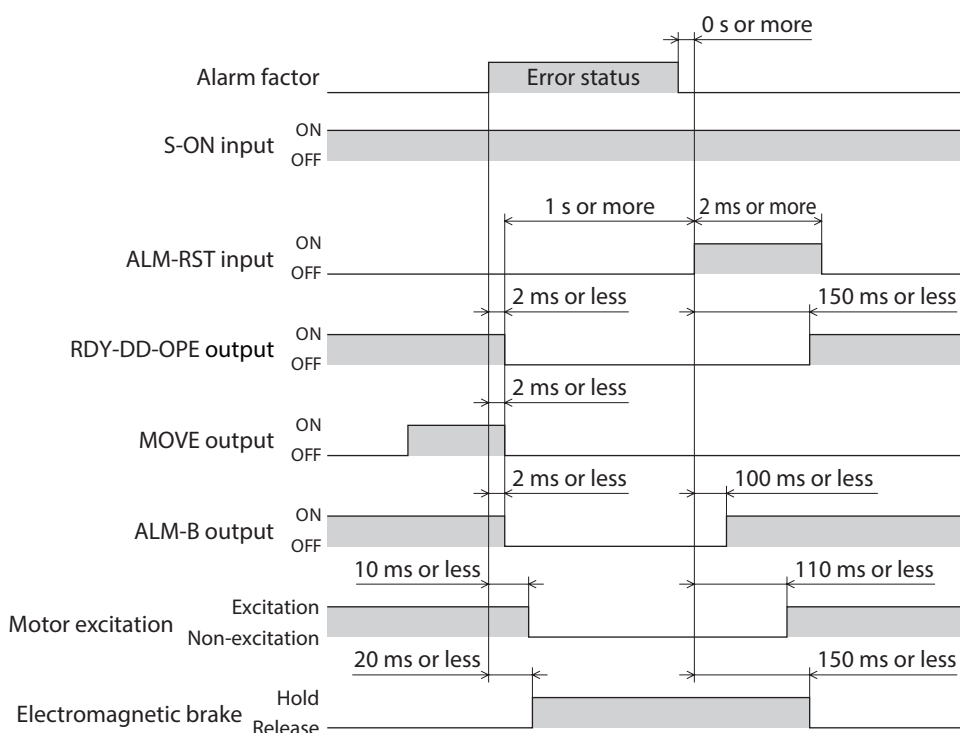
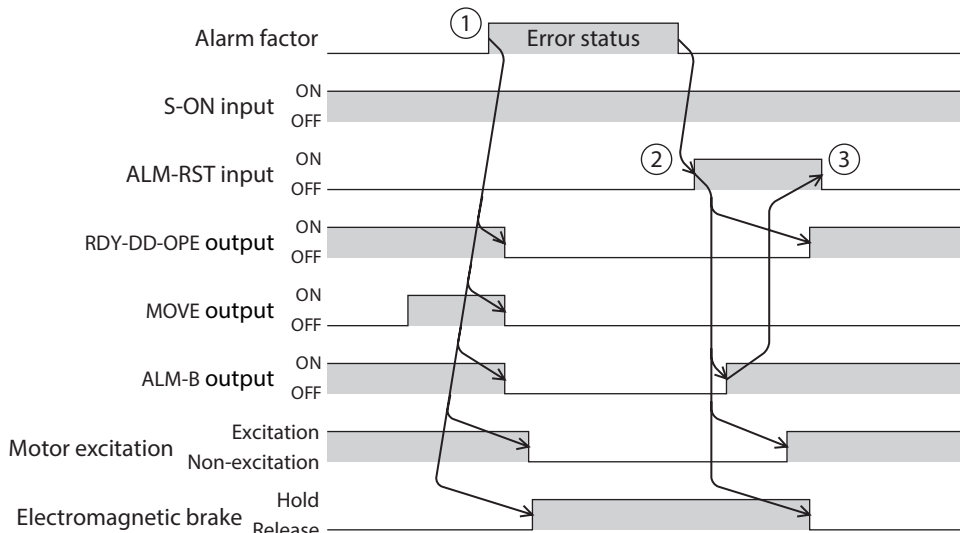

■ **When an alarm which motor excitation state is "Non-excitation after deceleration" is generated.**

1. If an error occurs, the ALM-B output and the RDY-DD-OPE output are turned OFF.
At the same time, the motor stops according to the value set in the "Stopping method alarm generation" parameter.
2. When the motor stops, it puts into a non-excitation state.
3. Remove the cause of the alarm and then turn the ALM-RST input ON.
The alarm is reset, and the ALM-B output and the RDY-DD-OPE output are turned ON.
4. Check the ALM-B output has been turned ON and then turn the ALM-RST input OFF.

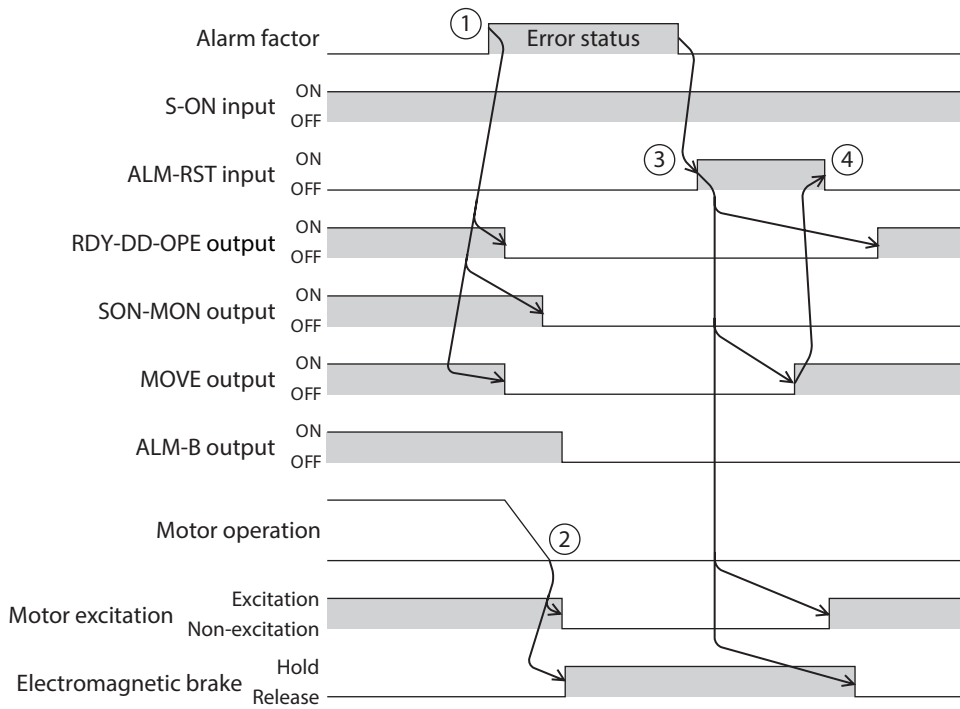

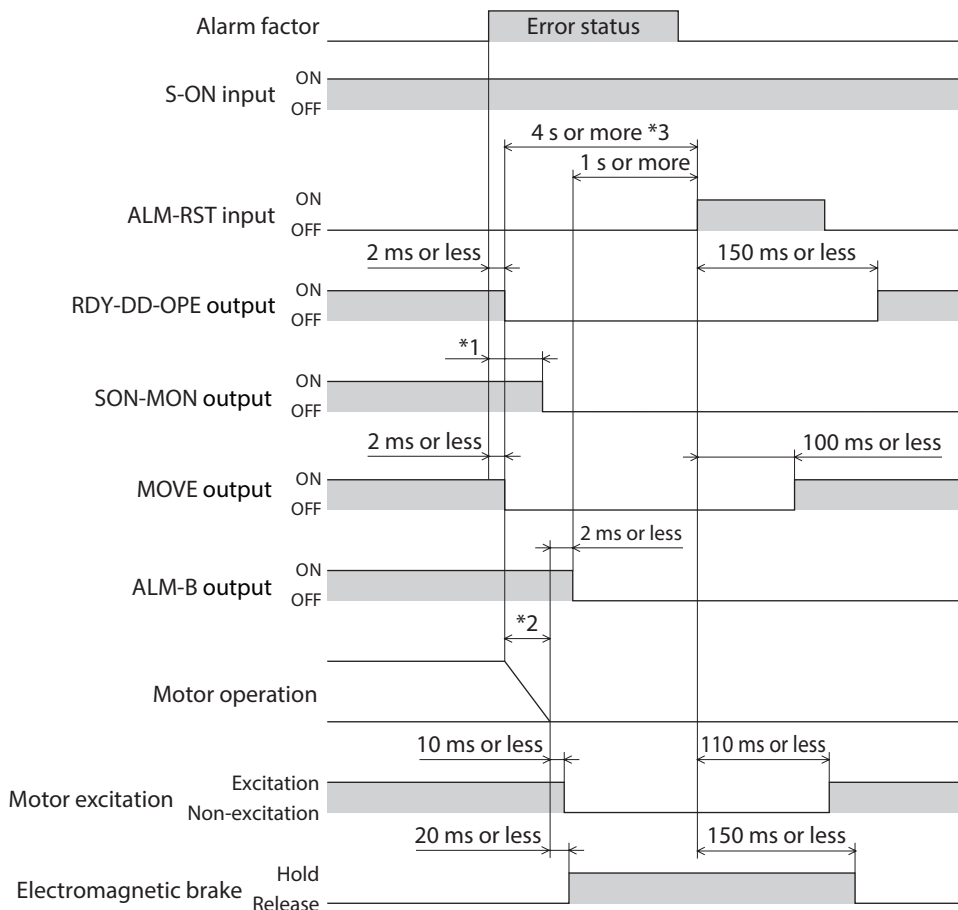

- *1 It varies depending on the driving condition.
- *2 It varies depending on the driving condition.
When a value set in the "Stopping timeout at alarm generation" parameter is exceeded, the motor puts into a non-excitation state even if it is not stopped.
- *3 It varies depending on the driving condition or the value set in the "Stopping timeout at alarm generation" parameter.

2 Information

The driver is equipped with a function to generate information output before an alarm is generated. If information is generated, a bit output of the corresponding information is turned ON. At the same time, the PWR/SYS LED blinks in blue. This function can be utilized for periodic maintenance of equipment by setting a suitable value in the parameter of each information. For example, utilizing the "Motor temperature information" parameter can prevent equipment malfunction or production stoppage due to motor overheat.



The motor continues to operate during information unlike in the case of an alarm.

2-1 Information output

There are three types of information outputs as shown below.

- **Information bit output**

If information is generated, a bit output (INFO-** output) of the corresponding information is turned ON.

- **Information group output**

If any of bit outputs of information in the group is turned ON, an information group output (INFO-**-G output) is turned ON.

When all bit outputs of information in the group are turned OFF, the group output is turned OFF.

- **Information output (INFO output)**

If any of bit outputs of information is turned ON, the INFO output is turned ON.

When all bit outputs of information are turned OFF, the INFO output is turned OFF.

Example: When the "Total uptime" information was generated

- INFO output = ON
- INFO-MNT-G output = ON
- INFO-PTIME output = ON

Relationship for each information output

Information output	Group output signal		Bit output signal	
	Description	Name	Description	Name
INFO	Assigned I/O status	INFO-USRIO-G	Assigned I/O status 0	INFO-USRIO0
			Assigned I/O status 1	INFO-USRIO1
			Assigned I/O status 2	INFO-USRIO2
			Assigned I/O status 3	INFO-USRIO3
			Assigned I/O status 4	INFO-USRIO4
			Assigned I/O status 5	INFO-USRIO5
			Assigned I/O status 6	INFO-USRIO6
			Assigned I/O status 7	INFO-USRIO7
	Start operation	INFO-START-G	Start homing operation error	INFO-START-HOME
			Start FW/RV operation error	INFO-START-FWRV
			Start stored data operation error	INFO-START-SD
			Start direct data operation error	INFO-START-DD
			Start drive profile error	INFO-START-DP
			I/O operation disabled	INFO-IODRV-DIS

Information output	Group output signal		Bit output signal	
	Description	Name	Description	Name
INFO	RS-485 communication	INFO-485-G	RS-485 communication error	INFO-485-ERR
			RS-485 communication processing time	INFO-485-PRCST
			RS-485 communication interval	INFO-485-INTVL
	Maintenance	INFO-MNT-G	Cumulative load 0	INFO-CULD0
			Cumulative load 1	INFO-CULD1
			User energy consumption	INFO-WH-USR
			Total energy consumption	INFO-WH-TOTAL
			Tripmeter 0	INFO-TRIP0
			Tripmeter 1	INFO-TRIP1
			Odometer	INFO-ODO
			Total uptime	INFO-PTIME
			Number of boots	INFO-PCOUNT
	Setting	INFO-SET-G	Unit setting	INFO-UNIT-E
			Software limit setting	INFO-SOFTLMT-E
	There is no corresponding group output.		Driver temperature	INFO-DRVTMP
			Motor temperature	INFO-MTRTMP
			Load factor	INFO-LOAD
			Torque	INFO-TRQ
			Power consumption	INFO-WATT
			Upper voltage	INFO-VOLT-H
			Lower voltage	INFO-VOLT-L
			Preset execution	INFO-PRESET
			Operation start restricted mode	INFO-DSLMTD
			I/O test mode	INFO-IOTEST
			Configuration request	INFO-CONFIG
			Reboot request	INFO-REBOOT
			Position deviation	INFO-POS-ERR
			Upper speed	INFO-SPD-H
			Lower speed	INFO-SPD-L
			Speed deviation	INFO-SPD-ERR
			Torque limiting time	INFO-TLC-TIME
			Settling time	INFO-STLTIME
			Energy consumption	INFO-WH-BOOT
			Positive direction main power supply current	INFO-MP-FWCRNT
Negative direction main power supply current			INFO-MP-RVCRNT	
CPU load			INFO-CPU-LOAD	
CAN communication warning			INFO-CAN-WNG	
Forward operation prohibition			INFO-FW-OT	
Reverse operation prohibition			INFO-RV-OT	
CPU error			INFO-CPU-FAULT	
Overcurrent error	INFO-OC-FAULT			
Encoder error	INFO-ENC-FAULT			

2-2 Clearing information

How to clear the information can be set with the "Information auto clear" parameter.

- **When the "Information auto clear" parameter is set to "1: Enable" (factory setting)**
The generated information will automatically be cleared if the condition to clear information is satisfied.
- **When the "Information auto clear" parameter is set to "0: Disable"**
Even if the condition to clear information is satisfied, the information is kept generated. The information can be cleared if one of the following is performed in a state where the condition to clear information is satisfied.
 - Execute the Clear information with the maintenance command via communication.
 - Execute the Clear information on the information monitor of the support software.
 - Turn the INFO-CLR input ON.
 - Turn on the main power supply again.

■ Related parameter

Parameter name	Description	Initial setting	
		Initial value	Unit
Information auto clear	When the condition to clear the information is satisfied, a bit output of the corresponding information is automatically turned OFF. [Setting range] 0: Disable 1: Enable	1	–

2-3 Information history

Up to 16 generated information items are stored in RAM in order of the latest to oldest. Information items stored as the information history are the information status and generation time.

The information history stored can be read or cleared when one of the following is performed.

- Read the information history with the monitor command via communication.
- Clear the information history with the maintenance command via communication.
- Read or clear the information history using the support software.

Note Information history is stored in RAM, so they are cleared when the main power supply of the driver is turned off.

2-4 Information list

Information item	Information bit output signal	Cause	Reset condition
Driver temperature	INFO-DRVTMP	The internal temperature of the driver increased to the value set in the "Driver temperature information" parameter or higher.	The internal temperature of the driver fell below the value set in the "Driver temperature information" parameter.
Motor temperature	INFO-MTRTMP	The detection temperature of the encoder increased to the value set in the "Motor temperature information" parameter or higher.	The detection temperature of the encoder fell below the value set in the "Motor temperature information" parameter.
Load factor	INFO-LOAD	The load factor of the motor increased to the value set in the "Load factor information" parameter or more.	The load factor of the motor fell below the value set in the "Load factor information" parameter.
Torque	INFO-TRQ	The detection torque of the motor increased to the value set in the "Torque information" parameter or more.	The detection torque of the motor fell below the value set in the "Torque information" parameter.
Power consumption	INFO-WATT	The power consumption increased to the value set in the "Power consumption information" parameter or more.	The power consumption fell below the value set in the "Power consumption information" parameter.
Upper voltage	INFO-VOLT-H	The inverter voltage increased to the value set in the "Upper voltage information" parameter or more.	The inverter voltage fell below the value set in the "Upper voltage information" parameter.
Lower voltage	INFO-VOLT-L	The main power supply voltage decreased to the value set in the "Lower voltage information" parameter or less.	The main power supply voltage exceeded the value set in the "Lower voltage information" parameter.
Preset execution	INFO-PRESET	Preset was executed by the position preset or homing operation.	Preset was completed.
Operation start restricted mode	INFO-DSLMTD	<ul style="list-style-type: none"> "Remote operation" was executed with the support software. Configuration was executed. Data was written to the driver from the support software. "Reset" was executed with the support software. 	<ul style="list-style-type: none"> Remote operation was canceled. Configuration was completed. Writing data was completed. Data was restored to the factory setting.
I/O test mode	INFO-IOTEST	<ul style="list-style-type: none"> "I/O test" was executed with the support software. Configuration was executed. 	<ul style="list-style-type: none"> The I/O test mode was canceled. Configuration was completed.
Configuration request	INFO-CONFIG	The parameter that required executing the configuration was changed.	Configuration was executed.
Reboot request	INFO-REBOOT	A parameter required the main power supply to turn on again was changed.	The main power supply was turned on again.
Assigned I/O status 0	INFO-USRIO0	The I/O signal set in the "INFO-USRIO0 output selection" parameter was turned ON.	The I/O signal set in the "INFO-USRIO0 output selection" parameter was turned OFF.
Assigned I/O status 1	INFO-USRIO1	The I/O signal set in the "INFO-USRIO1 output selection" parameter was turned ON.	The I/O signal set in the "INFO-USRIO1 output selection" parameter was turned OFF.
Assigned I/O status 2	INFO-USRIO2	The I/O signal set in the "INFO-USRIO2 output selection" parameter was turned ON.	The I/O signal set in the "INFO-USRIO2 output selection" parameter was turned OFF.
Assigned I/O status 3	INFO-USRIO3	The I/O signal set in the "INFO-USRIO3 output selection" parameter was turned ON.	The I/O signal set in the "INFO-USRIO3 output selection" parameter was turned OFF.

Information item	Information bit output signal	Cause	Reset condition
Assigned I/O status 4	INFO-USRIO4	The I/O signal set in the "INFO-USRIO4 output selection" parameter was turned ON.	The I/O signal set in the "INFO-USRIO4 output selection" parameter was turned OFF.
Assigned I/O status 5	INFO-USRIO5	The I/O signal set in the "INFO-USRIO5 output selection" parameter was turned ON.	The I/O signal set in the "INFO-USRIO5 output selection" parameter was turned OFF.
Assigned I/O status 6	INFO-USRIO6	The I/O signal set in the "INFO-USRIO6 output selection" parameter was turned ON.	The I/O signal set in the "INFO-USRIO6 output selection" parameter was turned OFF.
Assigned I/O status 7	INFO-USRIO7	The I/O signal set in the "INFO-USRIO7 output selection" parameter was turned ON.	The I/O signal set in the "INFO-USRIO7 output selection" parameter was turned OFF.
Position deviation	INFO-POS-ERR	The deviation between the demand position and the actual position increased to the value set in the "Position deviation information" parameter or more.	The deviation between the demand position and the actual position fell below the value set in the "Position deviation information" parameter.
Upper speed	INFO-SPD-H	The actual velocity of the motor increased to the value set in the "Upper speed information" parameter or more.	The actual velocity of the motor fell below the value set in the "Upper speed information" parameter.
Lower speed	INFO-SPD-L	When the demand velocity reaches the target velocity, the actual velocity of the motor decreased to the value set in the "Lower speed information" parameter or less.	<ul style="list-style-type: none"> • The actual velocity of the motor exceeded the value set in the "Lower speed information" parameter. • The target velocity was changed.
Speed deviation	INFO-SPD-ERR	The deviation between the demand velocity and the actual velocity increased to the value set in the "Speed deviation information" parameter or more.	The deviation between the demand velocity and the actual velocity fell below the value set in the "Speed deviation information" parameter.
Torque limiting time	INFO-TLC-TIME	The ON time of the TLC output increased to the value set in the "Torque limiting time information" parameter or more.	The TLC output was turned OFF.
Cumulative load 0	INFO-CULD0	The cumulative load increased to the value set in the "Cumulative load 0 information" parameter or more.	The cumulative load fell below the value set in the "Cumulative load 0 information" parameter.
Cumulative load 1	INFO-CULD1	The cumulative load increased to the value set in the "Cumulative load 1 information" parameter or more.	The cumulative load fell below the value set in the "Cumulative load 1 information" parameter.
Settling time	INFO-STLTIME	The settling time increased to the value set in the "Settling time information" parameter or more.	<ul style="list-style-type: none"> • Operation was started. • The settling time fell below the value set in the "Settling time information" parameter.
Energy consumption	INFO-WH-BOOT	The energy consumption increased to the value set in the "Energy consumption information" parameter or more.	<ul style="list-style-type: none"> • A value larger than the energy consumption was set to the "Energy consumption information" parameter again. • The main power supply was turned on again.
User energy consumption	INFO-WH-USR	The user energy consumption increased to the value set in the "User energy consumption information" parameter or more.	<ul style="list-style-type: none"> • A value larger than the user energy consumption was set to the "User energy consumption information" parameter again. • The user energy consumption was cleared using the support software or via communication.

Information item	Information bit output signal	Cause	Reset condition
Total energy consumption	INFO-WH-TOTAL	The total energy consumption increased to the value set in the "Total energy consumption information" parameter or more.	A value larger than the total energy consumption was set again to the "Total energy consumption information" parameter.
Positive direction main power supply current	INFO-MP-FWCRNT	The main power supply current increased to the value set in the "Positive direction main power supply current information" parameter or more.	The main power supply current fell below the value set in the "Positive direction main power supply current information" parameter.
Negative direction main power supply current	INFO-MP-RVCRNT	The main power supply current decreased to the value set in the "Negative direction main power supply current information" parameter or less.	The main power supply current exceeded the value set in the "Negative direction main power supply current information" parameter.
Tripmeter 0	INFO-TRIP0	The travel distance of the motor increased to the value set in the "Tripmeter 0 information" parameter or more.	<ul style="list-style-type: none"> • A value larger than the travel distance of the motor was set to the "Tripmeter 0 information" parameter again. • The tripmeter 0 was cleared using the support software or via communication.
Tripmeter 1	INFO-TRIP1	The travel distance of the motor increased to the value set in the "Tripmeter 1 information" parameter or more.	<ul style="list-style-type: none"> • A value larger than the travel distance of the motor was set to the "Tripmeter 1 information" parameter again. • The tripmeter 1 was cleared using the support software or via communication.
Odometer	INFO-ODO	The cumulative travel distance of the motor increased to the value set in the "Odometer information" parameter or more.	A value larger than the cumulative travel distance of the motor was set to the "Odometer information" parameter again.
CPU load	INFO-CPU-LOAD	The CPU load increased to the value set in the "CPU load information" parameter or more.	The CPU load fell below the value set in the "CPU load information" parameter.
Total uptime	INFO-PTIME	The total operation time of the driver increased to the value set in the "Total uptime information" parameter or more.	A value larger than the total operation time of the driver was set to the "Total uptime information" parameter again.
Number of boots	INFO-PCOUNT	The number of times of starting the driver increased to the value set in the "Number of boots information" parameter or more.	A value larger than the number of times of starting the driver was set to the "Number of boots information" parameter again.
RS-485 communication error	INFO-485-ERR	The RS-485 communication error was consecutively detected equal to or more than the value set in the "RS-485 communication error information" parameter.	RS-485 communication was performed properly.
RS-485 communication processing time	INFO-485-PRCST	The communication processing time of RS-485 communication increased to the value set in the "RS-485 communication processing time information" parameter or more.	The communication processing time of RS-485 communication fell below the value set in the "RS-485 communication processing time information" parameter.
RS-485 communication interval	INFO-485-INTVL	The communication interval of RS-485 communication increased to the value set in the "RS-485 communication interval information" parameter or more.	The communication interval of RS-485 communication fell below the value set in the "RS-485 communication interval information" parameter.

Information item	Information bit output signal	Cause	Reset condition
CAN communication warning	INFO-CAN-WNG	The value of the CAN communication transmission or reception error counter was exceeded 96.	The value of the CAN communication transmission or reception error counter was decreased to 96 or below.
Start homing operation error	INFO-START-HOME	Homing operation was executed when the RDY-HOME-OPE output was OFF.	Operation was started properly.
Start FW/RV operation error	INFO-START-FWRV	<ul style="list-style-type: none"> FW/RV operation was executed in the direction having prohibited by the FW-BLK input or the RV-BLK input. FW/RV operation was executed in the direction having prohibited by the FW-LS input or the RV-LS input. FW/RV operation was executed in the direction having stopped by the software limit. FW/RV operation was executed when the RDY-FWRV-OPE output was OFF. 	Operation was started properly.
Start stored data operation error	INFO-START-SD	<ul style="list-style-type: none"> Stored data operation was executed in the direction having prohibited by the FW-BLK input or the RV-BLK input. Stored data operation was executed in the direction having prohibited by the FW-LS input or the RV-LS input. Stored data operation was executed in the direction having stopped by the software limit. Stored data operation was executed when the RDY-SD-OPE output was OFF. 	Operation was started properly.
Start direct data operation error	INFO-START-DD	<ul style="list-style-type: none"> Direct data operation was executed in the direction having prohibited by the FW-BLK input or the RV-BLK input. Direct data operation was executed in the direction having prohibited by the FW-LS input or the RV-LS input. Direct data operation was executed in the direction having stopped by the software limit. Direct data operation was executed when the RDY-DD-OPE output was OFF. 	Operation was started properly.
Start drive profile error	INFO-START-DP	<ul style="list-style-type: none"> Drive profile was executed in the direction having prohibited by the FW-BLK input or the RV-BLK input. Drive profile was executed in the direction having prohibited by the FW-LS input or the RV-LS input. Drive profile was executed in the direction having stopped by the software limit. Drive profile was executed when the RDY-DPROF-OPE output was OFF. 	Operation was started properly.
I/O operation disabled	INFO-IODRV-DIS	An operation start signal is being ON when "I/O test" or "remote operation" of the support software was completed.	All operation start signal were turned OFF.

Information item	Information bit output signal	Cause	Reset condition
Forward operation prohibition	INFO-FW-OT	<ul style="list-style-type: none"> • Either the FW-LS input or the FW-BLK input was turned ON. • The demand position exceeded "Corrected max software limit." 	<ul style="list-style-type: none"> • Both the FW-LS input and the FW-BLK input were turned OFF. • The demand position fell in the range of "Corrected max software limit."
Reverse operation prohibition	INFO-RV-OT	<ul style="list-style-type: none"> • Either the RV-LS input or the RV-BLK input was turned ON. • The demand position exceeded "Corrected min software limit." 	<ul style="list-style-type: none"> • Both the RV-LS input and the RV-BLK input were turned OFF. • The demand position fell in the range of "Corrected min software limit."
Unit setting	INFO-UNIT-E	<ul style="list-style-type: none"> • The control resolution exceeding the specification value was set. • The velocity unit exceeding the specification value was set. 	<ul style="list-style-type: none"> • The control resolution was set in the range of the specification. • The velocity unit was set in the range of the specification.
Software limit setting	INFO-SOFTLMT-E	"Corrected max software limit" or "Corrected min software limit" was set outside the WRAP setting range.	"Corrected max software limit" and "Corrected min software limit" were set within the WRAP setting range.
CPU error	INFO-CPU-FAULT	The CPU overload alarm was generated.	The power supply was turned on again.
Overcurrent error	INFO-OC-FAULT	An alarm of overcurrent or electromagnetic brake overcurrent was generated.	The power supply was turned on again.
Encoder error	INFO-ENC-FAULT	An alarm of encoder error, encoder communication error, initial encoder error, or encoder EEPROM error was generated.	The power supply was turned on again.

■ Related parameters

Parameter name	Description	Initial setting	
		Initial value	Unit
INFO action (assigned I/O status group information (INFO-USRIO-G))	Sets whether or not to apply to the group output, INFO output, and LED blinking when information is generated. [Setting range] 0: INFO action is not applied * 1: INFO action is applied * The information history is left.	1	-
INFO action (start operation group information (INFO-START-G))			
INFO action (RS-485 communication group information (INFO-485-G))			
INFO action (maintenance group information (INFO-MNT-G))			
INFO action (setting group information (INFO-SET-G))			
INFO action (driver temperature information (INFO-DRVTMP))			
INFO action (motor temperature information (INFO-MTRTMP))			
INFO action (load factor information (INFO-LOAD))			
INFO action (torque information (INFO-TRQ))			
INFO action (power consumption information (INFO-WATT))			
INFO action (upper voltage information (INFO-VOLT-H))			
INFO action (lower voltage information (INFO-VOLT-L))			
INFO action (preset execution information (INFO-PRESET))			
INFO action (Operation start restricted mode information (INFO-DSLMTD))			
INFO action (I/O test mode information (INFO-IOTEST))			
INFO action (configuration request information (INFO-CONFIG))			
INFO action (reboot request information (INFO-REBOOT))			
INFO action (assigned I/O status 0 information (INFO-USRIO0))			
INFO action (assigned I/O status 1 information (INFO-USRIO1))			
INFO action (assigned I/O status 2 information (INFO-USRIO2))			
INFO action (assigned I/O status 3 information (INFO-USRIO3))			
INFO action (assigned I/O status 4 information (INFO-USRIO4))			
INFO action (assigned I/O status 5 information (INFO-USRIO5))			
INFO action (assigned I/O status 6 information (INFO-USRIO6))			
INFO action (assigned I/O status 7 information (INFO-USRIO7))			
INFO action (position deviation information (INFO-POS-ERR))			

Parameter name	Description	Initial setting	
		Initial value	Unit
INFO action (upper speed information (INFO-SPD-H))	Sets whether or not to apply to the group output, INFO output, and LED blinking when information is generated. [Setting range] 0: INFO action is not applied * 1: INFO action is applied * The information history is left.	1	-
INFO action (lower speed information (INFO-SPD-L))			
INFO action (speed deviation information (INFO-SPD-ERR))			
INFO action (torque limiting time information (INFO-TLC-TIME))			
INFO action (cumulative load 0 information (INFO-CULD0))			
INFO action (cumulative load 1 information (INFO-CULD1))			
INFO action (settling time information (INFO-STLTIME))			
INFO action (energy consumption information (INFO-WH-BOOT))			
INFO action (user energy consumption information (INFO-WH-USR))			
INFO action (total energy consumption information (INFO-WH-TOTAL))			
INFO action (positive direction main power supply current information (INFO-MP-FWCRNT))			
INFO action (negative direction main power supply current information (INFO-MP-RVCRNT))			
INFO action (tripmeter 0 information (INFO-TRIP0))			
INFO action (tripmeter 1 information (INFO-TRIP1))			
INFO action (odometer information (INFO-ODO))			
INFO action (CPU load information (INFO-CPU-LOAD))			
INFO action (total uptime information (INFO-PTIME))			
INFO action (number of boots information (INFO-PCOUNT))			
INFO action (RS-485 communication error information (INFO-485-ERR))			
INFO action (RS-485 communication processing time information (INFO-485-PRCST))			
INFO action (RS-485 communication interval information (INFO-485-INTVL))			
INFO action (CAN communication warning information (INFO-CAN-WNG))			
INFO action (start homing error information (INFO-START-HOME))			
INFO action (start FW/RV operation error information (INFO-START-FWRV))			
INFO action (start stored data operation error information (INFO-START-SD))			

Parameter name	Description	Initial setting	
		Initial value	Unit
INFO action (start direct data operation error information (INFO-START-DD))	Sets whether or not to apply to the group output, INFO output, and LED blinking when information is generated. [Setting range] 0: INFO action is not applied * 1: INFO action is applied * The information history is left.	1	-
INFO action (start drive profile error information (INFO-START-DP))			
INFO action (driving prohibited information (INFO-IDDRV-DIS))			
INFO action (forward operation prohibition information (INFO-FW-OT))			
INFO action (reverse operation prohibition information (INFO-RV-OT))			
INFO action (unit setting information (INFO-UNIT-E))			
INFO action (software limit setting information (INFO-SOFTLMT-E))			
INFO action (CPU fault information (INFO-CPU-FAULT))			
INFO action (over current fault information (INFO-OC-FAULT))			
INFO action (encoder fault information (INFO-ENC-FAULT))			
INFO-USRIO0 output selection			
INFO-USRIO1 output selection			
INFO-USRIO2 output selection			
INFO-USRIO3 output selection			
INFO-USRIO4 output selection			
INFO-USRIO5 output selection			
INFO-USRIO6 output selection			
INFO-USRIO7 output selection			
INFO-USRIO0 output inversion	Sets the ON/OFF inversion function to output signals to be checked with the INFO-USRIO0 to INFO-USRIO7 outputs. [Setting range] 0: Not invert 1: Invert	0	-
INFO-USRIO1 output inversion		0	-
INFO-USRIO2 output inversion		0	-
INFO-USRIO3 output inversion		0	-
INFO-USRIO4 output inversion		0	-
INFO-USRIO5 output inversion		0	-
INFO-USRIO6 output inversion		0	-
INFO-USRIO7 output inversion		0	-
Driver temperature information (INFO-DRVTMP)	Sets the condition in which the driver temperature information is generated. [Setting range] 0: Disable 1 to 120 °C	0	°C
Motor temperature information (INFO-MTRTMP)	Sets the condition in which the motor temperature information is generated. [Setting range] 0: Disable 1 to 120 °C	0	°C
Position deviation information (INFO-POS-ERR)	Sets the condition in which the position deviation information is generated. [Setting range] 0: Disable 1 to 10,000,000 (User-defined position unit)	0	step

Parameter name	Description	Initial setting	
		Initial value	Unit
Upper speed information (INFO-SPD-H)	Sets the condition in which the upper speed information is generated. [Setting range] 0: Disable 1 to 4,000,000 (User-defined position unit)	0	r/min
Lower speed information (INFO-SPD-L)	Sets the condition in which the lower speed information is generated. [Setting range] 0: Disable 1 to 4,000,000 (User-defined position unit)	0	r/min
Speed deviation information (INFO-SPD-ERR)	Sets the condition in which the speed deviation information is generated. [Setting range] 0: Disable 1 to 4,000,000 (User-defined position unit)	0	r/min
Load factor information (INFO-LOAD)	Sets the condition in which the load factor information is generated. [Setting range] 0: Disable 1 to 10,000 (1=0.1%)	0	1=0.1%
Torque information (INFO-TRQ)	Sets the condition in which the torque information is generated. [Setting range] 0: Disable 1 to 10,000 (1=0.1%)	0	1=0.1%
Torque limiting time information (INFO-TLC-TIME)	Sets the condition in which the torque limiting time information is generated. [Setting range] 0: Disable 1 to 10,000 ms	0	ms
Settling time information (INFO-STLTIME)	Sets the condition in which the settling time information is generated. [Setting range] 0: Disable 1 to 10,000 ms	0	ms
Upper voltage information (INFO-VOLT-H)	Sets the condition in which the upper voltage information is generated. [Setting range] 0: Disable 1 to 1,000 (1=0.1 V)	0	1=0.1 V
Lower voltage information (INFO-VOLT-L)	Sets the condition in which the lower voltage information is generated. [Setting range] 0: Disable 1 to 1,000 (1=0.1 V)	0	1=0.1 V
Positive direction main power supply current information (INFO-MP-FWCRNT)	Sets the condition in which the positive direction main power supply current information is generated. [Setting range] 0: Disable 1 to 500 (1=0.1 A)	0	1=0.1 A
Negative direction main power supply current information (INFO-MP-RVCRNT)	Sets the condition in which the negative direction main power supply current information is generated. [Setting range] 0: Disable -500 to -1 (1=0.1 A)	0	1=0.1 A

Parameter name	Description	Initial setting	
		Initial value	Unit
Power consumption information (INFO-WATT)	Sets the condition in which the power consumption information is generated. [Setting range] 0: Disable 1 to 10,000 (1=0.1 W)	0	1=0.1 W
Energy consumption information (INFO-WH-BOOT)	Sets the condition in which the energy consumption information is generated. [Setting range] 0: Disable 1 to 2,147,483,647 (1=0.001 Wh)	0	1=0.001 Wh
User energy consumption information (INFO-WH-USR)	Sets the condition in which the user energy consumption information is generated. [Setting range] 0: Disable 1 to 2,147,483,647 (Wh)	0	Wh
Total energy consumption information (INFO-WH-TOTAL)	Sets the condition in which the total energy consumption information is generated. [Setting range] 0: Disable 1 to 2,147,483,647 (Wh)	0	Wh
Tripmeter 0 information (INFO-TRIP0)	Sets the condition in which the tripmeter 0 information is generated. [Setting range] 0: Disable 1 to 2,147,483,647 (1=0.1 krev)	0	1=0.1 krev
Tripmeter 1 information (INFO-TRIP1)	Sets the condition in which the tripmeter 1 information is generated. [Setting range] 0: Disable 1 to 2,147,483,647 (1=0.1 krev)	0	1=0.1 krev
Odometer information (INFO-ODO)	Sets the condition in which the odometer information is generated. [Setting range] 0: Disable 1 to 2,147,483,647 (1=0.1 krev)	0	1=0.1 krev
Cumulative load 0 information (INFO-CULD0)	Sets the condition in which the cumulative load 0 information is generated. [Setting range] 0 to 2,147,483,647	0	–
Cumulative load 1 information (INFO-CULD1)	Sets the condition in which the cumulative load 1 information is generated. [Setting range] 0 to 2,147,483,647	0	–
Cumulative load value auto clear	Clears the cumulative load when operation is started (at the ON edge of the MOVE output). [Setting range] 0: Disable 1: Enable	1	–
Cumulative load value count divisor	Sets the divisor of the cumulative load. [Setting range] 1 to 32,767	1	–
RS-485 communication error information (INFO-485-ERR)	Sets the condition in which the RS-485 communication error information is generated. [Setting range] 0: Disable 1 to 10 times	0	–

Parameter name	Description	Initial setting	
		Initial value	Unit
RS-485 communication processing time information (INFO-485-PRCST)	Sets the condition in which the RS-485 communication processing time information is generated. [Setting range] 0: Disable 1 to 10,000 ms	0	ms
RS-485 communication interval information (INFO-485-INTVL)	Sets the condition in which the RS-485 communication interval information is generated. [Setting range] 0: Disable 1 to 10,000 ms	0	ms
CPU load information (INFO-CPU-LOAD)	Sets the condition in which the CPU load information is generated. [Setting range] 0: Disable 1 to 100%	0	%
Total uptime information (INFO-PTIME)	Sets the condition in which the total uptime information is generated. [Setting range] 0: Disable 1 to 30,000,000 min	0	min
Number of boots information (INFO-PCOUNT)	Sets the condition in which the number of boots information is generated. [Setting range] 0: Disable 1 to 2,147,483,647	0	–

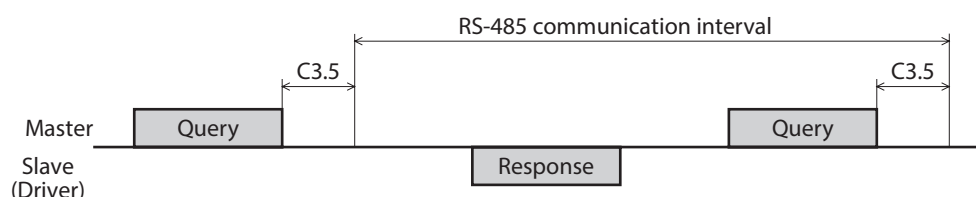

2-5 Information status

The information presently being generated can be checked using the "information status."
If information is generated, a bit corresponding to the information status is turned ON.
Refer to p.334 for bit arrangements of the information status.

2-6 LED indication for information

If information is generated, the PWR/SYS LED blinks in blue.
Changing the "Information LED condition" parameter can make the setting that the LED does not blink.

■ Related parameter

Parameter name	Description	Initial setting	
		Initial value	Unit
Information LED condition	Sets the LED status when information is generated. [Setting range] 0: Disable 1: Enable	1	–

8 Extended function

◆Table of contents

1	Gain tuning	464
1-1	Setting of load inertia.....	464
1-2	Setting of motor response.....	464
2	Vibration suppression	467
2-1	Command filter.....	467
2-2	Resonance suppression	469
2-3	Damping control	470
2-4	Electronic damper	470
3	Virtual input	471
4	User output	472
5	Data transfer	474
6	Cumulative load	475
7	Load factor monitor.....	477
8	Actual velocity monitor	478
9	Latch function.....	479
10	Driver simulation mode	482
10-1	Use this function for the following	482
10-2	Monitor	482
10-3	Operation.....	482
10-4	Alarm	483
11	LED of driver.....	484
11-1	Changing the lighting color of LED.....	484
11-2	Changing the lighting conditions of LED.....	485
11-3	Changing the LED blinking condition when the main power supply is turned on.....	486

1 Gain tuning

The motor response in reaction to the command can be adjusted according to the load inertia and the mechanical rigidity.

1-1 Setting of load inertia

Set the load inertia according to the load inertia of equipment.

Related parameters

Parameter name	Description	Initial setting	
		Initial value	Unit
Load inertia setting mode selection	Selects the setting method of the load inertia. [Setting range] -2: Automatic -1: "Load inertia setting" parameter is used 0: Small inertia (2 times) 1: Medium inertia (7.5 times) 2: Large inertia (20 times)	0	–
Load inertia setting	Sets the ratio of the load inertia to the motor rotor inertia. When the rotor inertia is equal to the load inertia, the ratio is 100%. [Setting range] 0 to 10000%	0	–

1-2 Setting of motor response

Set the motor response in reaction to the command.

Related parameter

Parameter name	Description	Initial setting	
		Initial value	Unit
Motor response setting	Selects the setting method of the motor response in reaction to the command. [Setting Range] -1: Manual setting 0 to 8	4	–

■ When setting "0" to "8" to the "Motor response setting" parameter

The table below shows each gain setting when "0" to "8" is set in the "Motor response setting" parameter.

Motor response setting	Position loop gain [Hz]	Speed loop gain [Hz]	Speed loop integral time constant [ms]	Speed feed-forward [%]	Torque filter [Hz]	Mechanical rigidity setting
0	1	14	51.00	80	300	0
1	2	22	51.00	80	300	1
2	3	32	48.20	80	320	2
3	5	46	33.80	80	460	3
4	6	56	28.40	80	560	4
5	7	68	23.40	80	680	5
6	8	82	19.40	80	820	6
7	10	100	15.80	80	1000	7
8	12	120	13.20	80	1200	8

■ When setting "-1: Manual setting" to the "Motor response setting" parameter

Related parameters

Parameter name	Description	Initial setting	
		Initial value	Unit
Mechanical rigidity setting	Selects the rigidity of equipment. The motor response improves as the setting value increases. An excessively high value may cause the motor to vibrate or to generate noise. [Setting range] 0 to 15	4	—
Position loop gain	Adjusts the motor response in reaction to the position deviation. Increasing the value will make the deviation between the demand position and the actual position smaller. An excessively large value may increase the motor overshoot or cause the motor vibration. [Setting range] 1 to 50 Hz	6	—
Speed loop gain	Adjusts the motor response in reaction to the speed deviation. Increasing the value will make the deviation between the demand velocity and the actual velocity smaller. An excessively large value may increase the motor overshoot or cause the motor vibration. [Setting range] 1 to 500 Hz	56	—
Speed loop integral time constant	Decreases the deviation that cannot be adjusted with the speed loop gain. An excessively long value may slow the motor response. Too short value may cause the motor vibration. [Setting range] 1 to 10,000 (1=0.01 ms)	2,840	1=0.01 ms
Electronic damper	Sets the electronic damper function for vibration suppression set in the motor in advance. [Setting range] 0: Disable 1: Enable	1	—
Torque filter (LPF)	Changes the motor response at high frequencies. [Setting range] 0 to 4700 Hz	560	Hz
Speed feed-forward	When the speed is constant, the deviation between the demand position and the actual position can be reduced to shorten the settling time. If it is set to 100%, the deviation will be approximately 0%. However, an excessively high value may increase the motor overshoot or cause the motor vibration. [Setting range] 0 to 100%	80	%



The above parameters are enabled only when the "Motor response setting" parameter is set to "-1: Manual setting."



Generally speaking, the order of rigidity arranged from low to high is as follows.
Belt and pulley - Rack and pinion - Ball screw - Rigid body (index table, gear, etc.)

■ **Control devices block diagram (position control)**

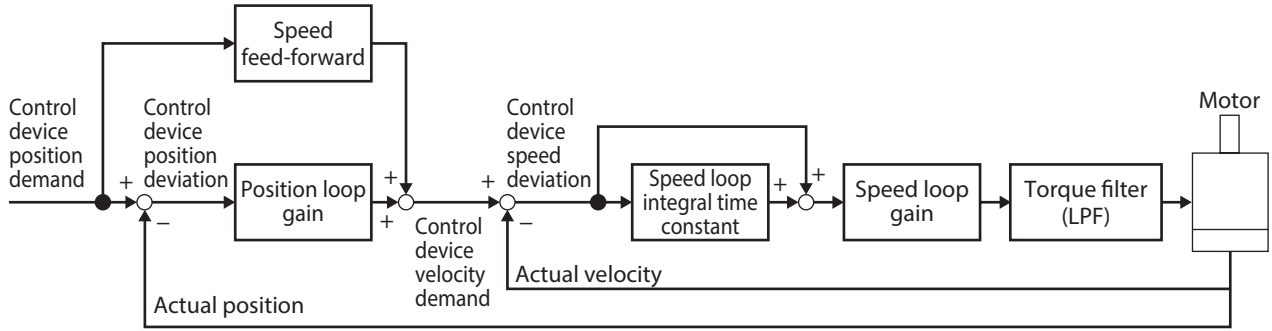

Name	Description
Control device position demand	Indicates the position demand of the control device (after command filter).
Actual position	Indicates the actual position.
Control device position deviation	Indicates the position deviation of the control device (after command filter).
Control device velocity demand	Indicates the velocity demand of the control device (after command filter).
Actual velocity	Indicates the actual velocity.
Control device speed deviation	Indicates the speed deviation of the control device (after command filter).

■ **Control devices block diagram (speed control)**

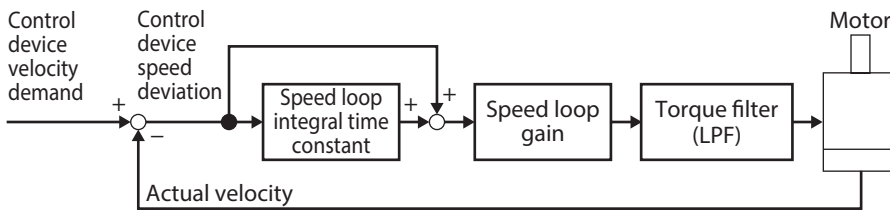

Name	Description
Control device velocity demand	Indicates the velocity demand of the control device (after command filter).
Actual velocity	Indicates the actual velocity.
Control device speed deviation	Indicates the speed deviation of the control device (after command filter).

2 Vibration suppression

2-1 Command filter

Using the command filter to adjust the motor response can suppress the motor vibration. There are two types of command filters, LPF (speed filter) and moving average filter.

Related parameters

Parameter name	Description	Initial setting	
		Initial value	Unit
Command filter setting	Select the command filter to be activated for the operation command. [Setting range] 1: LPF (speed filter) 2: Moving average filter	1	–
Command filter time constant	Sets the time constant for the command filter to adjust the motor response. [Setting range] 0 to 200 ms	1	ms

■ LPR (Speed filter)

Select "LPF (speed filter)" in the "Command filter setting" parameter, and set the "Command filter time constant" parameter.

Increasing a value in the "Command filter time constant" parameter can suppress the motor vibration at low speed operation and make the motor movement at starting/stopping smoother. However, setting an excessively high time constant reduces the synchronization performance in response to the command. Set an appropriate value according to a load or an application.

● When the "Command filter time constant" parameter is set to 0 ms

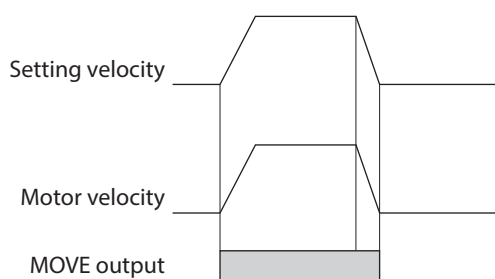

● When the "Command filter time constant" parameter is set to 200 ms

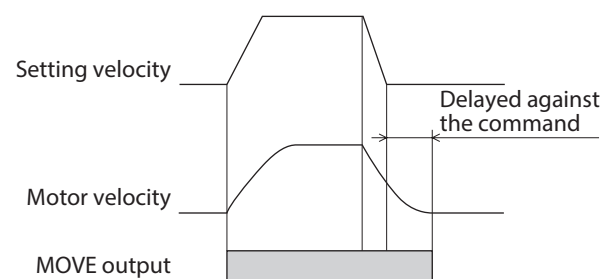

■ Moving average filter

Select "Moving average filter" in the "Command filter setting" parameter, and set the "Command filter time constant" parameter.

The motor response can be adjusted. In addition, the positioning time can be shortened by suppressing the residual vibration in positioning operation.

The optimal value for the "Command filter time constant" parameter varies depending on a load or operating condition. Set an appropriate value according to a load or operating condition.

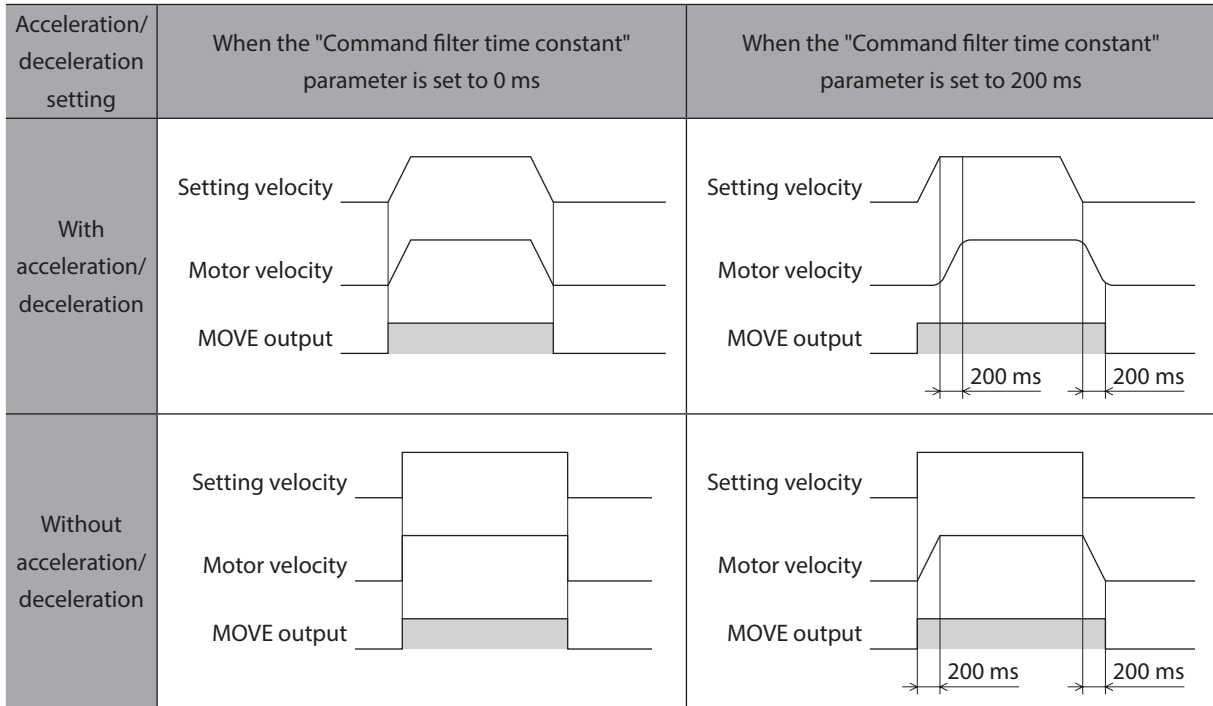

■ Command filter and deviation monitor

Deviation monitor	Description
Position deviation	Indicates the deviation between the demand position before the command filter and the actual position.
Control device position deviation	Indicates the deviation between the demand position after the command filter and the actual position. Refer to p.466 for details.
Speed deviation	Indicates the deviation between the demand velocity before the command filter and the actual velocity.
Control device speed deviation	Indicates the deviation between the demand velocity after the command filter and the actual velocity. Refer to p.466 for details.

2-2 Resonance suppression

Set the filter for suppressing the motor resonance.

Related parameters

Parameter name	Description	Initial setting	
		Initial value	Unit
Resonance suppression control A frequency	Sets the frequency of vibration to be suppressed. [Setting range] 100 to 3,200 Hz	1,000	Hz
Resonance suppression control A gain	Sets the gain to suppress the vibration. Increasing the value causes the motor response to the deviation to lower. [Setting range] 0 to 100%	0	%
Resonance suppression control A width	Sets the width of vibration to be suppressed. [Setting range] 30 to 120	30	–
Resonance suppression control B frequency	Sets the frequency of vibration to be suppressed. [Setting range] 100 to 3,200 Hz	1,000	Hz
Resonance suppression control B gain	Sets the gain to suppress the vibration. Increasing the value causes the motor response to the deviation to lower. [Setting range] 0 to 100%	0	%
Resonance suppression control B width	Sets the width of vibration to be suppressed. [Setting range] 30 to 120	30	–
Resonance suppression control C frequency	Sets the frequency of vibration to be suppressed. [Setting range] 100 to 3,200 Hz	1,000	Hz
Resonance suppression control C gain	Sets the gain to suppress the vibration. Increasing the value causes the motor response to the deviation to lower. [Setting range] 0 to 100%	0	%
Resonance suppression control C width	Sets the width of vibration to be suppressed. [Setting range] 30 to 120	30	–
Resonance suppression control D frequency	Sets the frequency of vibration to be suppressed. [Setting range] 100 to 3,200 Hz	1,000	Hz
Resonance suppression control D gain	Sets the gain to suppress the vibration. Increasing the value causes the motor response to the deviation to lower. [Setting range] 0 to 100%	0	%
Resonance suppression control D width	Sets the width of vibration to be suppressed. [Setting range] 30 to 120	30	–

2-3 Damping control

Even when the motor is installed in a machine with low rigidity, residual vibration during positioning can be suppressed to shorten the positioning time.
(The optimal value varies depending on the equipment or operating condition.)

Related parameters

Parameter name	Description	Initial setting	
		Initial value	Unit
Damping control frequency	Sets the frequency of vibration to be suppressed. [Setting range] 700 to 20,000 (1=0.01 Hz)	10,000	1=0.01 Hz
Damping control gain	Sets the gain for damping control (vibration suppression control). [Setting range] 0 to 100%	0	%

2-4 Electronic damper

Whether to enable or disable the electronic damper function for vibration suppression having set in the motor beforehand can be set.
(Depending on a coupling and a load, the setting to disable may be more effective for vibration suppression.)

Related parameter

Parameter name	Description	Initial setting	
		Initial value	Unit
Electronic damper	Sets the electronic damper function for vibration suppression set in the motor in advance. [Setting range] 0: Disable 1: Enable	1	–

3 Virtual input

The virtual input (VIR-IN) is a function that uses the output signal assigned to the virtual input source to configure the input to the set input signal. Assign two output signals (A and B) to one virtual input. VIR-IN is input after the logical combination of A and B is established.

No wiring is required and this function can be used together with direct I/O because of the input method to use the internal I/O. Up to 8 virtual inputs can be set.

Related parameters

Parameter name	Description	Initial setting	
		Initial value	Unit
Virtual input function (link)	Selects the input signals to be assigned to VIR-IN0 to VIR-IN7. [Setting range] ⇒ "2-1 Input signals list" on p.151	0: Not used	–
Virtual input source A function	Selects the virtual input source A function (output signal) for VIR-IN0 to VIR-IN7. [Setting range] ⇒ "2-2 Output signals list" on p.154	128: CONST-OFF	–
Virtual input source A inverting mode	Changes ON/OFF of the virtual input source A. [Setting range] 0: Not invert 1: Invert	0	–
Virtual input source B function	Selects the virtual input source B function (output signal) for VIR-IN0 to VIR-IN7. [Setting range] ⇒ "2-2 Output signals list" on p.154	128: CONST-OFF	–
Virtual input source B inverting mode	Changes ON/OFF of the virtual input source B. [Setting range] 0: Not invert 1: Invert	0	–
Virtual input logical operation	Sets the logical combination of virtual input source A and virtual input source B. [Setting range] 0: AND 1 OR	1	–
Virtual input ON signal dead time	Sets the ON signal dead-time for VIR-IN0 to VIR-IN7. (The input signal is turned ON when the time having set is exceeded.) [Setting range] 0 to 4,000 ms	0	ms
Virtual input 1 shot signal	Enables the 1-shot signal function for VIR-IN0 to VIR-IN7. (The input signal having been turned ON is automatically turned OFF after 250 μs.) [Setting range] 0: Disable 1: Enable	0	–

Setting example: When the TLC output is turned ON using VIR-IN0, turn the STOP input ON to stop the motor.

	Virtual input function (link)	Virtual input source A function	Virtual input source A inverting mode	Virtual input source B function	Virtual input source B inverting mode	Virtual input logical operation	Virtual input ON signal dead time	Virtual input 1 shot signal mode
VIR-IN0	STOP	TLC	Not invert	CONST-OFF	Not invert	OR	0	Enable

4 User output

The user output (USR-OUT) is a function that controls the output based on a logical conjunction or logical disjunction of two types of output signals and the comparison result with the internal monitor group.
 Up to 8 user outputs can be set.
 The output condition of the user output can be selected from the following two items.

■ Internal IO judgment

Assign two types of signals (A and B) to a single user output. USR-OUT is output after the logical combination of A and B is established.

■ Value judgment

Set the ON condition to a single user output. USR-OUT is output after the ON condition is established.

Related parameters

Parameter name	Description	Initial setting	
		Initial value	Unit
User output operation mode	Selects the operation mode of the user output. [Setting range] 0: Internal IO judgment 1: Value judgment (value X, value Y) = (value A, value B) 2: Value judgment (value X, value Y) = (value of NET-ID=A, value B) 3: Value judgment (value X, value Y) = (value A, value of NET-ID=B) 4: Value Judgment (value X, value Y) = (value of NET-ID=A, value of NET-ID=B)	0	–
User output (IO) source A function	Selects the user output source A function (output signal) for USR-OUT0 to USR-OUT7. [Setting range] ⇨ "2-2 Output signals list" on p.154	128: CONST-OFF	–
User output (IO) source A inverting mode	Changes ON/OFF of the user output source A. [Setting range] 0: Not invert 1: Invert	0	–
User output (IO) source B function	Selects the user output source B function (output signal) for USR-OUT0 to USR-OUT7. [Setting range] ⇨ "2-2 Output signals list" on p.154	128: CONST-OFF	–
User output (IO) source B inverting mode	Changes ON/OFF of the user output source B. [Setting range] 0: Not invert 1: Invert	0	–
User output (IO) logical operation	Sets the logical combination of user output source A and user output source B. [Setting range] 0: AND 1 OR	1	–

Parameter name	Description	Initial setting	
		Initial value	Unit
User output (value) ON condition	Selects the ON condition of the user output. [Setting range] 0: (value of target NET-ID + value Y) = (value X) 1: (target NET-ID value + value Y) < (value X) 2: (value of target NET-ID + value Y) ≤ (value X) 3: (value X) < (value of target NET-ID + value Y) 4: (value X) ≤ (value of target NET-ID + value Y) 5: (value of target NET-ID) < (value X) or (value Y) < (value of target NET-ID) 6: (value of target NET-ID) ≤ (value X) or (value Y) ≤ (value of target NET-ID) 7: (value X) < (value of target NET-ID) < (value Y) 8: (value X) ≤ (value of target NET-ID) ≤ (value Y) 9: (value Y) = ((value of target NET-ID) And (value X)) 10: (value Y) = ((value of target NET-ID) Or (value X)) 11: ((value of target NET-ID) And (value X)) is not 0	0	–
User output (value) target NET-ID	Sets the target NET-ID of the user output. [Setting range] 0 to 65,535	0	–
User output (value) value A	Sets the value A of the user ID. [Setting range] –2,147,483,648 to 2,147,483,647	0	–
User output (value) value B	Sets the value B of the user output. [Setting range] –2,147,483,648 to 2,147,483,647	0	–

Setting example: Using **USR-OUT0**, if the **IN-POS** output and the **RDY-SD-OPE** outputs are turned ON, **USR-OUT0** is output.

Output signal	User output operation mode	User output (IO) source A function	User output (IO) source A inverting mode	User output (IO) source B function	User output (IO) source B inverting mode	User output (IO) logical operation
USR-OUT0	Internal IO judgment	IN-POS	0: Not invert	RDY-SD-OPE	0: Not invert	0: AND

5 Data transfer

The data transfer (DTF) is a function that transfers the data (value) to a specified NET-ID using internal I/O.

Related parameters

Parameter name	Description	Initial setting	
		Initial value	Unit
Data transfer trigger IO	Selects the output signal to be triggered data transfer. [Setting range] ⇒ "2-2 Output signals list" on p.154	0: Not used	–
Data transfer trigger form	Selects the edge shape to be triggered. [Setting range] 0: Positive-Edge 1: Negative-Edge 2: Double-Edge	0	–
Data transfer transfer mode	Selects the transfer mode of data transfer. [Setting range] 0: Transfers the value of the argument NET-ID to the target NET-ID 1: Transfers the value of the argument NET-ID to the target NET-ID with AND-Logic synthesis 2: Transfers the value of the argument NET-ID to the target NET-ID with OR-Logic synthesis 3: Transfers the value of the argument NET-ID to the target NET-ID with CLR-Logic synthesis 4: Transfers the value of the argument NET-ID to the target NET-ID with Additive function 8: Transfers the value of the argument to the target NET-ID 9: Transfers the value of the argument to the target NET-ID with AND-Logic synthesis 10: Transfers the value of the argument to the target NET-ID with OR-Logic synthesis 11: Transfers the value of the argument to the target NET-ID with CLR-Logic synthesis 12: Transfers the value of the argument to the target NET-ID with Additive function	0	–
Data transfer argument	Sets the value or NET-ID (data source) to be transferred in data transfer. [Setting range] –2,147,483,648 to 2,147,483,647	0	–
Data transfer target NET-ID	Sets the NET-ID (data destination) to be transferred in data transfer. [Setting range] 0 to 65,535	0	–



When an alarm of "CPU overload" is generated, the data transfer function is disabled.

6 Cumulative load

The driver obtains the load factor in the motor operation pattern as an area, and it can notify as information if the integrated area (load) exceeds a certain value. This is a useful function that can be used as a guide for the motor life and the aged deterioration of equipment.

■ How to consider the cumulative load

As the operating time of equipment passes, a friction force and load will be increased by adhesion of rusts or foreign particles, deterioration of greases and others.

Estimating this kind of load increase (cumulative load) and setting to the information can prevent the equipment from stopping due to aging problems. Set a value having enough allowance because the load increases at starting or stopping.

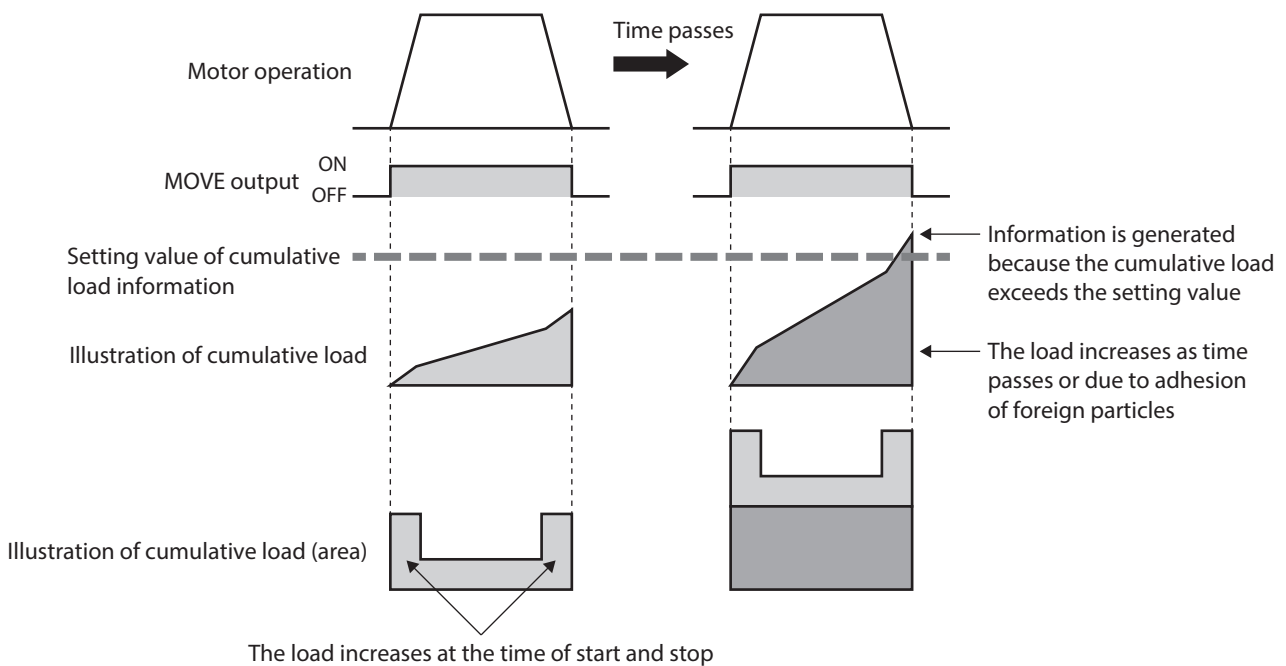

■ How to use

1. Open the status monitor window of the support software during operation to check the cumulative load in the normal operation pattern.
Use this value having enough allowance and estimate the maximum value of the cumulative load.
2. Set the maximum value determined in the step 1 to the information.
3. Equipment starts operating, and when the cumulative load of the motor increases to reach "5,000," the information is generated.
Perform maintenance on the equipment.



The information is cleared when the main power supply of the driver is turned off because the cumulative load is stored in RAM.

■ "Cumulative load value count divisor" parameter

The upper limit to count the cumulative load is 2,147,483,647.

If the operating time is long, the cumulative load may increase, making it difficult to manage or exceeding the upper limit.

In this case, use the "Cumulative load value count divisor" parameter. The "Cumulative load value count divisor" parameter is a divisor used to divide the count value of the cumulative load. Dividing by the cumulative load value count divisor makes it easier to manage the count value.

- When the "Cumulative load value count divisor" parameter is "1"

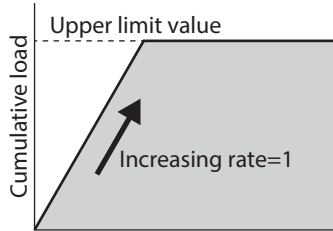

The upper limit value has been reached while operation is continued to perform, and the cumulative load cannot be counted

- When the "Cumulative load value count divisor" parameter is "5"

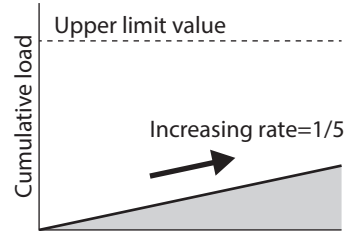

Increase slows down because the count value of the cumulative load is divided by "5"

■ "Cumulative load value auto clear" parameter

- If the "Cumulative load value auto clear" parameter is set to "Enable" (initial value: Enable), the cumulative load is cleared to 0 each time the MOVE output is turned ON. The cumulative load can be reset for each operation.
- If the "Cumulative load value auto clear" parameter is set to "Disable," the cumulative load is not reset even if the MOVE output is turned ON, and it is continued to integrate. The cumulative load can be monitored for a certain period of time or under a certain condition. When this parameter is set to "Disable," reset the cumulative load with the LAT-CLR input.

- When the "Cumulative load value auto clear" parameter is enabled

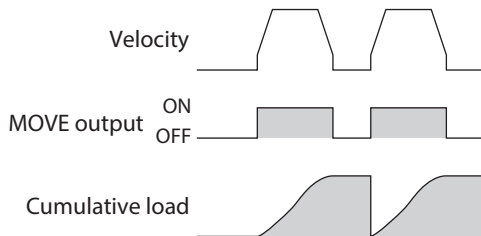

- When the "Cumulative load value auto clear" parameter is disabled

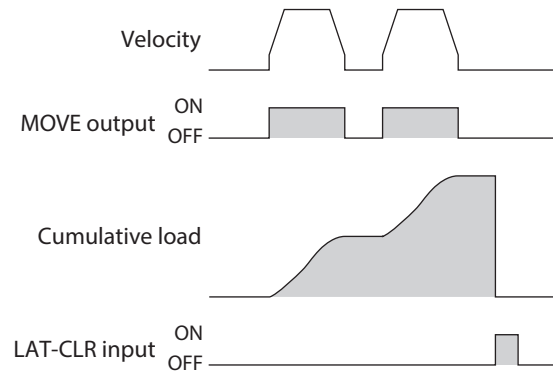

7 Load factor monitor

There are two methods to monitor the load factor of the motor.

- Torque monitor: This indicates the output torque presently generated as a percentage of the rated torque being 100%.
- Load factor monitor: This indicates the output torque presently generated as a percentage of the maximum torque in the continuous duty region being 100%.

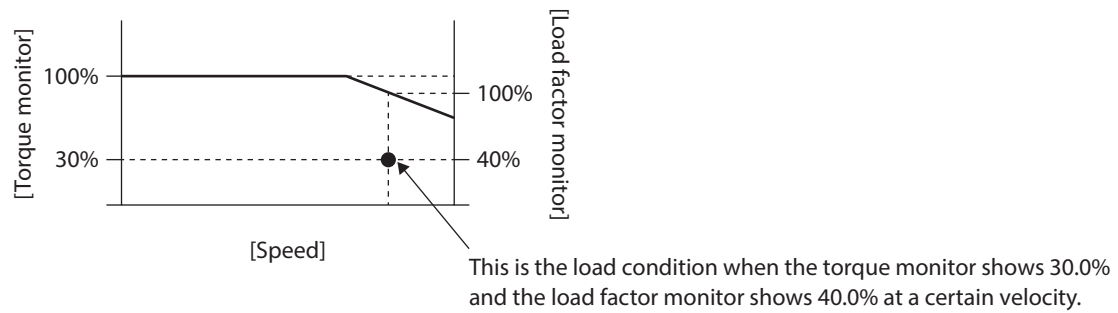

8 Actual velocity monitor

The filter time constant (LPF) of the actual velocity can be changed.

Related parameter

Parameter name	Description	Initial setting	
		Initial value	Unit
Actual velocity monitor time constant	Sets the time constant of the actual velocity monitor. [Setting range] 1 to 100 ms	5	ms

Related monitor commands

Name	Description	Initial setting	
		Initial value	Unit
Actual velocity (User-defined velocity unit)	Indicates the present actual velocity. (User-defined velocity unit)	–	r/min
Actual velocity (r/min)	Indicates the present actual velocity. (r/min)	–	r/min
Actual velocity (step/s)	Indicates the present actual velocity. (step/s)	–	step/s

9 Latch function

The latch function is a function that saves the instantaneous operation information in the driver when the operation is switched by an event jump or the operation is stopped. For example, if operation is switched by the NEXT input during continuous operation, the operation information at the moment of switching is latched. A trigger to generate a latch, such as the event jump or the NEXT input, is called "latch trigger." The operation information saved by the latch function is maintained until it is cleared. The latched operation information can be used for maintenance of the equipment and checking the operation situation.

■ Information to be latched

- Demand position: Demand position when the latch trigger is generated
- Actual position: Actual position when the latch trigger is generated
- Target position: Target position of operation for the transition destination when latched by the event jump or the NEXT input.
Target position of operation having stopped when latched by operation stop.
Target position at which the latch trigger is generated when latched by the user latch input.
- Operation data number: Operation data number when latched
- Number of loop times: When latched while loop operation is executed, the number of loop times when latched is saved.
- Number of latch times: The number of times latched is saved.
- Latch time: Continuous uptime when latched is saved.

memo All information having latched is cleared if the power supply is turned on again.

■ Types of latch trigger

● User latch input

- When the USR-LAT-IN0 input or the USR-LAT-IN1 input is input
- When the ZSG-N output is turned ON

memo

- The input source of the user latch input can be changed using the parameter.
- The user latch input saves the latch information by both ON edge and OFF edge.

Related parameters

Parameter name	Description	Initial setting	
		Initial value	Unit
USR-LAT0 source	Selects the input source of USR-LAT0. [Setting range] 0: IO for latch (USR-LAT-IN0) 1: Phase Z (ZSG-N)	0	—
USR-LAT1 source	Selects the input source of USR-LAT1. [Setting range] 0: IO for latch (USR-LAT-IN1) 1: Phase Z (ZSG-N)	0	—

● Event jump [(Low) I/O event number, (Middle) I/O event number, (High) I/O event number], NEXT input

- During stored data operation, when the event jump [(Low) I/O event number, (Middle) I/O event number, (High) I/O event number] is generated to switch the operation.
- During stored data operation, when the NEXT input is input to switch the operation.

● Stop of operation

- When operation is stopped by the S-ON input, the FREE input, the CLR input, the QSTOP input, or the STOP input.
- When operation is stopped by the Quick stop event or the Halt event.
- When operation is stopped by software overtravel or hardware overtravel.
- When operation was stopped by alarm generation.
- When operation is stopped by the FW-BLK input while operation in the forward direction is executed.
- When operation is stopped by the RV-BLK input while operation in the reverse direction is executed.
- When operation is stopped by "Stop operation" of the maintenance command.
- When the power supply for communication is lost and operation is stopped.

■ Operation of latch trigger

There are two types of latch trigger operation, "1 shot" and "Continuous."
It can be set for each latch trigger.

- 1 shot: The latched value is maintained until the LAT-CLR input is turned from OFF to ON.
- Continuous: The value is overwritten each time the latch trigger is generated.

Related parameters

Parameter name	Description	Initial setting	
		Initial value	Unit
LAT-JUMP0 action	Selects the movement of the latch by the low event. [Setting range] 0: 1 shot 1: Continuous	0	–
LAT-JUMP1 action	Indicates the movement of the latch by the middle event. [Setting range] 0: 1 shot 1: Continuous	0	–
LAT-JUMP2 action	Selects the movement of the latch by the high event. [Setting range] 0: 1 shot 1: Continuous	0	–
LAT-NEXT action	Selects the movement of the latch by the NEXT input. [Setting range] 0: 1 shot 1: Continuous	0	–
LAT-STOP action	Selects the movement of the latch by the stop input. [Setting range] 0: 1 shot 1: Continuous	0	–
USR-LAT0 action	Selects the movement of the latch by USR-LAT0. [Setting range] 0: 1 shot 1: Continuous	0	–
USR-LAT1 action	Selects the movement of the latch by USR-LAT1. [Setting range] 0: 1 shot 1: Continuous	0	–

■ Related I/O signals

● Input signals

- LAT-CLR input
- USR-LAT-IN0 input
- USR-LAT-IN1 input

● Output signals

- USR-LAT0 output
- USR-LAT1 output
- JUMP0-LAT output
- JUMP1-LAT output
- JUMP2-LAT output
- NEXT-LAT output
- STOP-LAT output
- ZSG-N output

10 Driver simulation mode

Using the driver simulation mode can simulate coordinates and I/O status without connecting a motor.

In the driver simulation mode, the PWR/SYS LED is lit as follows.

Repeating "Green light → Red light → Green and red are simultaneously lit (yellow) → No light"

Note

- In the driver simulation mode, the motor does not operate regardless of whether or not the motor is connected.
- In the driver simulation mode, the driver functions and I/O signals may differ from those in the normal state.

memo

Even if a motor and a driver are connected, the motor is in a non-excitation state during the simulation.
When an electromagnetic brake motor is used, the motor output shaft is held by the electromagnetic brake.

Related parameter

Parameter name	Description	Initial setting	
		Initial value	Unit
Driver operation mode	Operation can be simulated using a virtual motor without connecting a motor. [Setting range] 0: Use real motor 1: Virtual motor	0	–

10-1 Use this function for the following

- To check the driver command information
- To check the wiring
- To check the operation data and parameters
- To check the input signal status.
- To check the output signal status.
- Verification when an error occurs in the system

10-2 Monitor

In the driver simulation mode, the following monitor values are indefinite.

- Cumulative load
- Torque
- Load factor
- Position deviation
- Speed deviation
- Control device position deviation
- Control device speed deviation
- Settling time
- ATL torque limiting value

10-3 Operation

The driver simulation mode is in a state where an external load does not exist.

The output torque and actual velocity of the motor are calculated values using a virtual motor as a model.

Therefore, exercise caution when simulating the operation based on the output torque such as push-motion operation.

Also, in homing operation, external sensors cannot be detected because the motor does not rotate. When homing operation is simulated, it is necessary to turn the sensor input ON intentionally.

10-4 Alarm

In the driver simulation mode, an alarm of "Initial encoder error" is not generated.

11 LED of driver

Various driver status can be checked by the lighting state or the number of blinks of LEDs on the driver.



When each color is lit on the LED together, the colors are overlapped.
Refer to the "Operating Manual Installation and Connection Edition" for LED indication of the driver.

11-1 Changing the lighting color of LED

The lighting colors of the PWR/SYS LED and the COMM LED can be changed.

Related parameter

Parameter name	Description	Initial setting	
		Initial value	Unit
LED (PWR/C-DAT) color changing	The lighting colors of the PWR/SYS LED and the COMM LED can be changed. [Setting range] 0: Green 1: White	1	–

11-2 Changing the lighting conditions of LED

The function of the COMM LED can be changed to ON/OFF indication of the output signal. There is a method of use, for instance, that the LED is lit in white when a specific output signal is ON or in red when OFF.

Related parameters

Parameter name	Description	Initial setting																				
		Initial value	Unit																			
LED-OUT mode	Sets the information to be indicated by the PWR/SYS LED and the COMM LED. [Setting range] <table border="1" style="margin-left: 20px;"> <thead> <tr> <th rowspan="2">Setting value</th> <th colspan="2">LED status</th> </tr> <tr> <th>PWR/SYS</th> <th>COMM</th> </tr> </thead> <tbody> <tr> <td>-3</td> <td colspan="2">No LED output *1</td> </tr> <tr> <td>-2</td> <td colspan="2">No LED output (Except when an alarm is present)*1</td> </tr> <tr> <td>-1</td> <td rowspan="2">Normal operation</td> <td>No LED output</td> </tr> <tr> <td>0</td> <td>I/O status</td> </tr> <tr> <td>1</td> <td></td> <td>Normal operation</td> </tr> </tbody> </table>	Setting value	LED status		PWR/SYS	COMM	-3	No LED output *1		-2	No LED output (Except when an alarm is present)*1		-1	Normal operation	No LED output	0	I/O status	1		Normal operation	1	–
Setting value	LED status																					
	PWR/SYS	COMM																				
-3	No LED output *1																					
-2	No LED output (Except when an alarm is present)*1																					
-1	Normal operation	No LED output																				
0		I/O status																				
1		Normal operation																				
LED-OUT-GREEN function	Selects the output signal to be indicated by the green LED. *2 [Setting range] ⇨ "2-2 Output signals list" on p.154	128: CONST-OFF	–																			
LED-OUT-GREEN inverting mode	Sets whether to invert ON/OFF when the internal I/O is output with LED-OUT-GREEN. [Setting range] 0: Not invert 1: Invert	0	–																			
LED-OUT-RED function	Selects the output signal to be indicated by the red LED. *2 [Setting range] ⇨ "2-2 Output signals list" on p.154	128: CONST-OFF	–																			
LED-OUT-RED inverting mode	Sets whether to invert ON/OFF when the internal I/O is output with LED-OUT-RED. [Setting range] 0: Not invert 1: Invert	0	–																			
LED-OUT-BLUE function	Selects the output signal to be indicated by the blue LED. *2 [Setting range] ⇨ "2-2 Output signals list" on p.154	128: CONST-OFF	–																			
LED-OUT-BLUE inverting mode	Sets whether to invert ON/OFF when the internal I/O is output with LED-OUT-BLUE. [Setting range] 0: Not invert 1: Invert	0	–																			

*1 The PWR/SYS LED is lit in red for maximum one second when the main power supply is turned on.

*2 It operates only when the "LED-OUT mode" parameter is set to "0."

11-3 Changing the LED blinking condition when the main power supply is turned on

The COMM LED can blink when the main power supply is turned on.

Related parameters

Parameter name	Description	Initial setting	
		Initial value	Unit
Number of times the GREEN LED blinks at booting	The COMM LED can blink in green when the main power supply is turned on. [Setting range] 0 to 9 times	0	–
Number of times the RED LED blinks at booting	The COMM LED can blink in red when the main power supply is turned on. [Setting range] 0 to 9 times	0	–
Number of times the BLUE LED blinks at booting	The COMM LED can blink in blue when the main power supply is turned on. [Setting range] 0 to 9 times	0	–

9 Appendix

◆ Table of contents

1	Relation between operation types and operation data/parameters.....	488
---	---	-----



1 Relation between operation types and operation data/parameters

Parameter name	Drive profile	Direct data operation	Stored data operation	FW/RV operation						Homing operation			
				JOG operation	High-speed JOG operation	Inching operation	Continuous operation (position control)	Continuous operation (speed control)	Continuous operation (push-motion)	2-sensor mode	3-sensor mode	One-way rotation mode	Push mode
Operation data	-	○	○	-	-	-	○	○	○	-	-	-	-
Operation I/O event	-	-	○	-	-	-	-	-	-	-	-	-	-
Command filter setting	○	○	○	○	○	○	○	○	○	○	○	○	○
Command filter time constant	○	○	○	-	-	-	○	○	○	-	-	-	-
Starting velocity	○	○	○	-	-	-	○	○	○	-	-	-	-
Permission of absolute positioning without setting absolute coordinates	○	○	○	-	-	-	-	-	-	-	-	-	-
Acceleration/deceleration setting method	○	○	○	-	-	-	○	○	○	-	-	-	-
Automatic S-ON for the FW/RV operation	-	-	-	○	○	○	○	○	○	-	-	-	-
Accept stored data override operation start by START input	-	-	○	-	-	-	-	-	-	-	-	-	-
User-defined position unit setting	○	○	○	-	-	○	-	-	-	○	○	○	○
User-defined velocity unit setting	○	○	○	○	○	○	○	○	○	○	○	○	○
User acceleration/deceleration unit setting	-	○	○	○	○	○	○	○	○	○	○	○	○
(JOG) Travel amount	-	-	-	○	-	○	-	-	-	-	-	-	-
(JOG) Operating velocity	-	-	-	○	○	○	-	-	-	-	-	-	-
(JOG) Acceleration/deceleration	-	-	-	○	○	○	-	-	-	-	-	-	-
(JOG) Starting velocity	-	-	-	○	○	○	-	-	-	-	-	-	-
(JOG) Operating velocity (high)	-	-	-	-	○	-	-	-	-	-	-	-	-
JOG/HOME command filter time constant	-	-	-	○	○	○	-	-	-	○	○	○	○
JOG/HOME Torque limit value	-	-	-	○	○	○	-	-	-	○	○	○	○
(HOME) Homing mode	-	-	-	-	-	-	-	-	-	○	○	○	○
(HOME) Starting direction	-	-	-	-	-	-	-	-	-	○	○	○	○
(HOME) Acceleration/deceleration	-	-	-	-	-	-	-	-	-	○	○	○	○
(HOME) Starting velocity	-	-	-	-	-	-	-	-	-	○	○	○	○
(HOME) Operating velocity	-	-	-	-	-	-	-	-	-	○	○	○	○
(HOME) Last velocity	-	-	-	-	-	-	-	-	-	○	○	○	○
(HOME) SLIT detection	-	-	-	-	-	-	-	-	-	○	○	○	○

Parameter name	Drive profile	Direct data operation	Stored data operation	FW/RV operation						Homing operation			
				JOG operation	High-speed JOG operation	Inching operation	Continuous operation (position control)	Continuous operation (speed control)	Continuous operation (push-motion)	2-sensor mode	3-sensor mode	One-way rotation mode	Push mode
(HOME) ZSG signal detection	-	-	-	-	-	-	-	-	-	○	○	○	○
(HOME) Travel amount of additional operation after homing	-	-	-	-	-	-	-	-	-	○	○	○	○
(HOME) Backward steps in 2 sensor homing	-	-	-	-	-	-	-	-	-	○	-	-	-
(HOME) Operating amount in unidirectional homing	-	-	-	-	-	-	-	-	-	-	-	○	-
(HOME) Torque limit value for push-homing	-	-	-	-	-	-	-	-	-	-	-	-	○
(HOME) Backward steps after first entry in push-homing	-	-	-	-	-	-	-	-	-	-	-	-	○
(HOME) Pushing time in push-homing	-	-	-	-	-	-	-	-	-	-	-	-	○
(HOME) Backward steps in push-homing	-	-	-	-	-	-	-	-	-	-	-	-	○

■ Revision record

Revision number	Revised contents
First edition	
Second edition	<ul style="list-style-type: none">• Added 400 W• Update according to design change of driver firmware version 3.00
Third edition	Added 60 W

- Unauthorized reproduction or copying of all or part of this manual is prohibited.
If a new copy is required to replace an original manual that has been damaged or lost, please contact your nearest Oriental Motor branch or sales office.
- Oriental Motor shall not be liable whatsoever for any problems relating to industrial property rights arising from use of any information, circuit, equipment or device provided or referenced in this manual.
- Characteristics, specifications and dimensions are subject to change without notice.
- While we make every effort to offer accurate information in the manual, we welcome your input. Should you find unclear descriptions, errors or omissions, please contact the nearest office.
- **Orientalmotor** is a registered trademark or trademark of Oriental Motor Co., Ltd., in Japan and other countries.
Modbus is a registered trademark of Schneider Automation Inc.
CiA® and CANopen® are registered trademarks of CAN in Automation e.V.
Other product names and company names mentioned in this manual may be registered trademarks or trademarks of their respective companies and are hereby acknowledged. The third-party products mentioned in this manual are recommended products, and references to their names shall not be construed as any form of performance guarantee. Oriental Motor is not liable whatsoever for the performance of these third-party products.

© Copyright ORIENTAL MOTOR CO., LTD. 2021

Published in July 2022

- Please contact your nearest Oriental Motor office for further information.

ORIENTAL MOTOR U.S.A. CORP.
Technical Support Tel:800-468-3982
8:30am EST to 5:00pm PST (M-F)
www.orientalmotor.com

ORIENTAL MOTOR (EUROPA) GmbH
Schiessstraße 44, 40549 Düsseldorf, Germany
Technical Support Tel:00 800/22 55 66 22
www.orientalmotor.de

ORIENTAL MOTOR (UK) LTD.
Unit 5 Faraday Office Park, Rankine Road,
Basingstoke, Hampshire RG24 8QB UK
Tel:+44-1256347090
www.oriental-motor.co.uk

ORIENTAL MOTOR (FRANCE) SARL
Tel:+33-1 47 86 97 50
www.orientalmotor.fr

ORIENTAL MOTOR ITALIA s.r.l.
Tel:+39-02-93906347
www.orientalmotor.it

ORIENTAL MOTOR ASIA PACIFIC PTE. LTD.
Singapore
Tel:1800-842-0280
www.orientalmotor.com.sg

ORIENTAL MOTOR (MALAYSIA) SDN. BHD.
Tel:1800-806-161
www.orientalmotor.com.my

ORIENTAL MOTOR (THAILAND) CO., LTD.
Tel:1800-888-881
www.orientalmotor.co.th

ORIENTAL MOTOR (INDIA) PVT. LTD.
Tel:1800-120-1995 (For English)
1800-121-4149 (For Hindi)
www.orientalmotor.co.in

TAIWAN ORIENTAL MOTOR CO., LTD.
Tel:0800-060708
www.orientalmotor.com.tw

SHANGHAI ORIENTAL MOTOR CO., LTD.
Tel:400-820-6516
www.orientalmotor.com.cn

INA ORIENTAL MOTOR CO., LTD.
Korea
Tel:080-777-2042
www.inaom.co.kr

ORIENTAL MOTOR CO., LTD.
4-8-1 Higashiueno, Taito-ku, Tokyo
110-8536 Japan
Tel:+81-3-6744-0361
www.orientalmotor.co.jp