

SH Geared Type

Motor Frame Size 28 mm (1.10 in.)

PK Series



20 mm (0.79 in.)

28 mm (1.10 in.)

35 mm (1.38 in.)

42 mm (1.65 in.)

50 mm (1.97 in.)

56.4 mm (2.22 in.)

60 mm (2.36 in.)

85 mm (3.35 in.)

90 mm (3.54 in.)

Specifications (RoHS)

Motor Specifications

Model	Connection Type	Rated Current	Voltage	Resistance	Inductance	Rotor Inertia J		Lead Wires (Pins)	Corresponding DC-Input Motor & Driver Package
		A/phase	VDC	Ω/phase	mH/phase	kg·m ²	oz·in ²		
PK223PA-SG□ PK223PB-SG□ PK223PAR15S□	Bipolar (Series)	0.67	3.8	5.6	4	9×10 ⁻⁷	0.049	6	CMK223□P-SG□/ CMK223PR15S□
	Unipolar	0.95	2.66	2.8	1				

- Wirings and connections → Page A-288
- Encoder specifications → Page A-17
- Enter **A** (single shaft) or **B** (double shaft) in the box (□) within the model name.
- Enter the gear ratio in the box (■) within the model name.
- Product Number Code → Page A-278
- Backlash value is approximately 1 to 2°.

Note

- Direction of rotation of the motor and that of the gear output shaft are the same for the gear ratios 7.2 and 36. It is opposite for 9, 10 and 18 gear ratios.

Gearmotor Specifications

Model	Gear Ratio	Holding Torque*		Step Angle	Permissible Speed r/min
		N·m	oz·in		
PK223P□-SG7.2 PK223PAR15S7.2	7.2	0.3	42	0.25°	250
PK223P□-SG9 PK223PAR15S9	9	0.3	42	0.2°	200
PK223P□-SG10 PK223PAR15S10	10	0.3	42	0.18°	180
PK223P□-SG18 PK223PAR15S18	18	0.4	56	0.1°	100
PK223P□-SG36 PK223PAR15S36	36	0.4	56	0.05°	50

- Enter **A** (Single shaft) or **B** (double shaft) in the box (□) within the model name.

* Holding torque is the same regardless of the connection type due to the permissible torque limit of the gearhead.

Dimensions Unit = mm (in.)

The dimension of a motor with an encoder can be found on page A-19 or at www.orientalmotor.com.

Model	Mass kg (lb.)	DXF
PK223PA-SG□ PK223PB-SG□	0.16 (0.35)	B335

- Enter the gear ratio in the box (□) within the model name.
- Lead wire and connector are not supplied with the connector-coupled motor and must be purchased separately.
- Connection cable is available as an accessory (sold separately).
- Screws (Included)
M2.5 Length 8 mm (0.31 in.)...4 pieces
- Applicable Connector
Connector housing: 51065-0600 (MOLEX)
Contact: 50212-8100 (MOLEX)
Crimp tool: 57176-5000 (MOLEX)

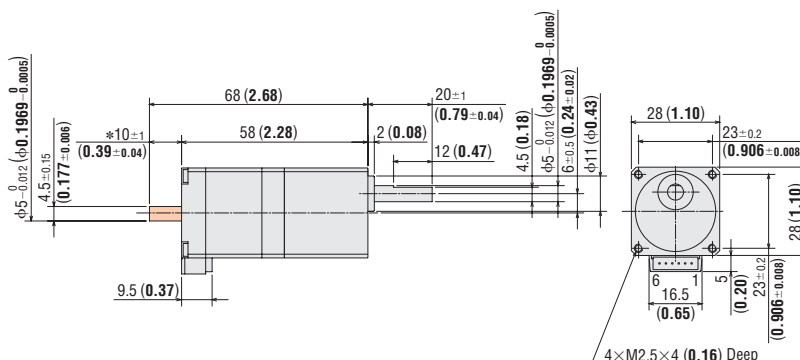

* The length of machining on the double shaft model is 10±0.25 (0.394±0.010).

- These dimensions are for the double shaft models. For the single shaft models, ignore the orange (■) area.

Speed – Torque Characteristics

PK223P□-SG■/PK223PAR15S■

Bipolar (Series) 24 VDC

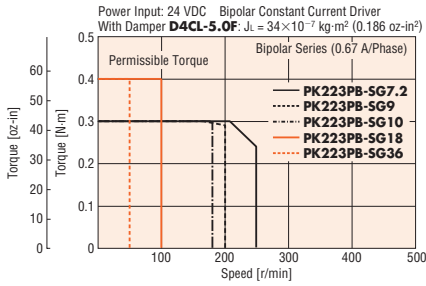

PK223P□-SG■/PK223PAR15S■

Bipolar (Series) 48 VDC

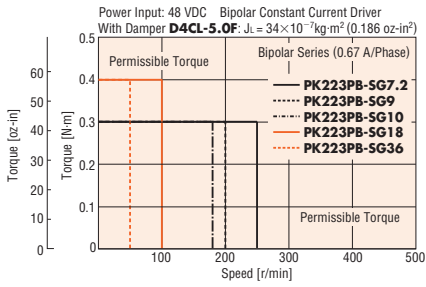

- Enter **A** (single shaft) or **B** (double shaft) in the box (□) within the model name.
- Enter the gear ratio in the box (■) within the model name.

Note

- Pay attention to heat dissipation from motor as there will be a considerable amount of heat under certain conditions. Be sure to keep the temperature of the motor case under 100°C (212°F).

Accessories (Sold separately)

The connection cable is available as an accessory.

- Connection cable → Page A-409

PK223P□-SG■/PK223PAR15S■

Unipolar

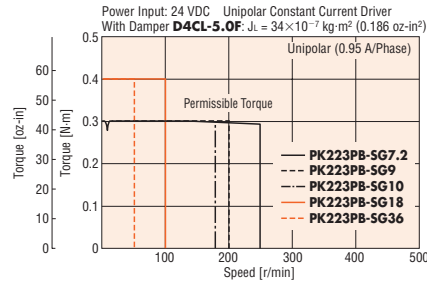

Introduction	
AR	0.36° / Geared
AS	AC Input Motor & Driver
RK	0.72° / Geared
UMK	0.9°/1.8°
AR	0.36° / Geared
ASX	DC Input Motor & Driver
CRK	0.36°/0.72° / Geared
CMK	0.9°/1.8° / Geared
RBK	1.8° / Geared
PK	0.36°
PK	0.72°
PK	0.9°
PK/PV	1.8°
PK	Geared
SCX10 / EMP400 / SG8030J	Controllers
	Accessories

SH Geared Type

Motor Frame Size 42 mm (1.65 in.)

PK Series



- 20 mm (0.79 in.)
- 28 mm (1.10 in.)
- 35 mm (1.38 in.)
- 42 mm (1.65 in.)
- 50 mm (1.97 in.)
- 56.4 mm (2.22 in.)
- 60 mm (2.36 in.)
- 85 mm (3.35 in.)
- 90 mm (3.54 in.)

Specifications (RoHS)

Motor Specifications

Model • Single Shaft • Double Shaft • with Encoder	Connection Type	Rated Current A/phase	Voltage VDC	Resistance Ω/phase	Inductance mH/phase	Rotor Inertia J		Lead Wires	Corresponding DC-Input Motor & Driver Package CMK Series
						kg-m ²	oz-in ²		
PK243A1A-SG PK243B1A-SG PK243A1AR-S	Bipolar (Series)	0.67	5.6	8.4	10	35×10 ⁻⁷	0.191	6	CMK243□PA-SG/ CMK243PAR□S
	Unipolar	0.95	4.0	4.2	2.5				
PK243A2A-SG PK243B2A-SG	Bipolar (Series)	0.28	13	48	60	35×10 ⁻⁷	0.191	6	-
	Unipolar	0.4	9.6	24	15				

- Wirings and connections → Page A-288
- Encoder specifications → Page A-17
- Enter **A** (single shaft) or **B** (double shaft) in the box (□) within the model name.
Enter the gear ratio in the box (■) within the model name.
Enter the encoder code (**15**, **16**, **25** or **26**) in the box (□) within the model name.
Product Number Code → Page A-278
- Backlash value is approximately 1 to 2°.

Note

- Direction of rotation of the motor and that of the gear output shaft are the same for the gear ratios 3.6, 7.2, 9 and 10.
It is opposite for 18 and 36 gear ratios.

Gearmotor Specifications

Model • Single Shaft/Double Shaft • with Encoder	Gear Ratio	Holding Torque*		Step Angle	Permissible Speed r/min
		N-m	lb-in		
PK243□1A-SG3.6, PK243□2A-SG3.6 PK243A1AR□S3.6	3.6	0.2	1.77	0.5°	500
PK243□1A-SG7.2, PK243□2A-SG7.2 PK243A1AR□S7.2	7.2	0.4	3.5	0.25°	250
PK243□1A-SG9, PK243□2A-SG9 PK243A1AR□S9	9	0.5	4.4	0.2°	200
PK243□1A-SG10, PK243□2A-SG10 PK243A1AR□S10	10	0.56	4.9	0.18°	180
PK243□1A-SG18, PK243□2A-SG18 PK243A1AR□S18	18	0.8	7.0	0.1°	100
PK243□1A-SG36, PK243□2A-SG36 PK243A1AR□S36	36	0.8	7.0	0.05°	50

- Enter **A** (Single shaft) or **B** (double shaft) in the box (□) within the model name.
Enter the encoder code (**15**, **16**, **25** or **26**) in the box (□) within the model name.
- * Holding torque is the same regardless of the connection type due to the permissible torque limit of the gearhead.

Dimensions Unit = mm (in.)

The dimension of a motor with an encoder can be found on page A-19 or at www.orientalmotor.com.

Model	Mass kg (lb.)	DXF
PK243A□A-SG PK243B□A-SG	0.35 (0.77)	B091U

- Enter the winding specification in the box (□) within the model name.
- Enter the gear ratio in the box (■) within the model name.
- Screws (Included)
No.4-40 UNC Length 10 mm (0.39 in.)...4 pieces

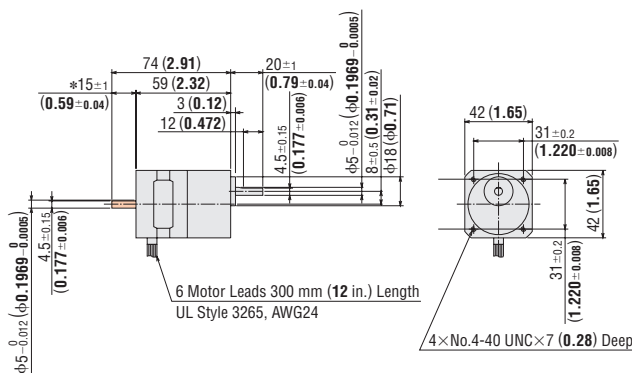

* The length of machining on the double shaft model is 15±0.25 (0.591±0.010).

- These dimensions are for the double shaft models. For the single shaft models, ignore the orange (■) area.

Speed – Torque Characteristics

PK243 1A-SG / PK243A1AR S

Bipolar (Series) 24 VDC

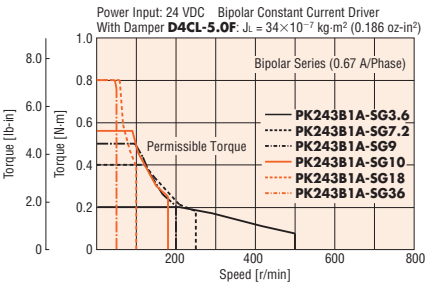

PK243 1A-SG / PK243A1AR S

Unipolar

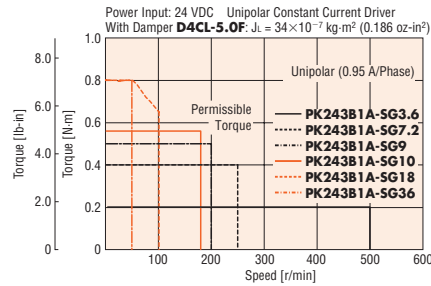

PK243 1A-SG / PK243A1AR S

Bipolar (Series) 48 VDC

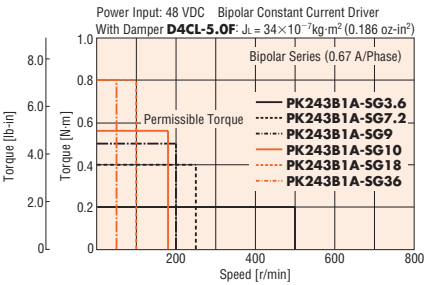

PK243 2A-SG

Bipolar (Series) 24 VDC

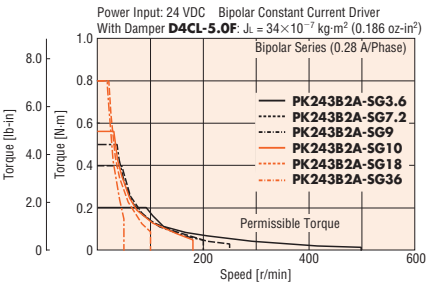

PK243 2A-SG

Unipolar

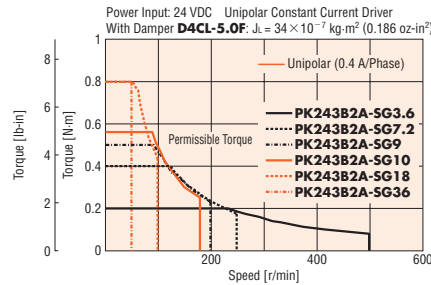

PK243 2A-SG

Bipolar (Series) 48 VDC

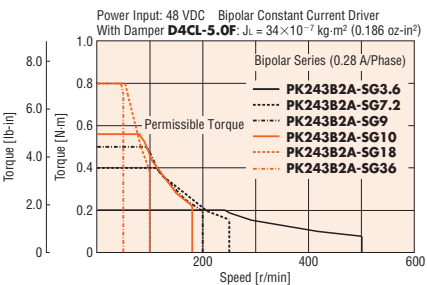

- Enter **A** (single shaft) or **B** (double shaft) in the box (□) within the model name.
- Enter the gear ratio in the box (■) within the model name.
- Enter the encoder code (**15**, **16**, **25** or **26**) in the box (▢) within the model name.

Note

- Pay attention to heat dissipation from motor as there will be a considerable amount of heat under certain conditions. Be sure to keep the temperature of the motor case under 100°C (212°F).

Introduction	
AR	AC Input Motor & Driver
AR	0.36° / Geared
AS	0.72° / Geared
RK	0.9° / 1.8°
UMK	0.36° / Geared
AR	0.36° / Geared
ASX	0.36° / Geared
CRK	0.36° / 0.72° / Geared
CMK	0.9° / 1.8° / Geared
RBK	1.8° / Geared
PK	0.36°
PK	0.72°
PK	0.9°
PK/PV	1.8°
PK	Geared
SCX10 / EMP400 / SG80301	Controllers
	Accessories

SH Geared Type

Motor Frame Size 60 mm (2.36 in.)

PK Series



20 mm (0.79 in.)

28 mm (1.10 in.)

35 mm (1.38 in.)

42 mm (1.65 in.)

50 mm (1.97 in.)

56.4 mm (2.22 in.)

60 mm (2.36 in.)

85 mm (3.35 in.)

90 mm (3.54 in.)

Specifications (RoHS)

Motor Specifications

Model	Connection Type	Rated Current	Voltage	Resistance	Inductance	Rotor Inertia J		Lead Wires (Pins)	Corresponding DC-Input Motor & Driver Package
		A/phase	VDC	Ω/phase	mH/phase	kg·m ²	oz·in ²		
PK264A1A-SG <input type="checkbox"/> PK264B1A-SG <input type="checkbox"/>	Bipolar (Series)	0.71	8.1	11.4	21.6	120×10 ⁻⁷	0.66	6	-
	Unipolar	1	5.7	5.7	5.4				
PK264A2A-SG <input type="checkbox"/> PK264B2A-SG <input type="checkbox"/> PK264A2AR <input type="checkbox"/> S <input type="checkbox"/>	Bipolar (Series)	1.4	3.9	2.8	5.6	120×10 ⁻⁷	0.66	6	CMK264 <input type="checkbox"/> PA-SG <input type="checkbox"/> CMK264PAR <input type="checkbox"/> S <input type="checkbox"/>
	Unipolar	2	2.8	1.4	1.4				

- Wirings and connections → Page A-288
Encoder specifications → Page A-17
- Enter **A** (single shaft) or **B** (double shaft) in the box (□) within the model name.
Enter the gear ratio in the box (■) within the model name.
Enter the encoder code (**15**, **16**, **25** or **26**) in the box (□) within the model name.
Product Number Code → Page A-278
- Backlash value is approximately 1 to 2°.

Note

- Direction of rotation of the motor and that of the gear output shaft are the same for the gear ratios 3.6, 7.2, 9 and 10.
It is opposite for 18 and 36 gear ratios.

Gearmotor Specifications

Model •Single Shaft/Double Shaft	Gear Ratio	Holding Torque*		Step Angle	Permissible Speed r/min
		N·m	lb·in		
PK264 <input type="checkbox"/> 1A-SG3.6, PK264 <input type="checkbox"/> 2A-SG3.6 PK264A2AR <input type="checkbox"/> S3.6	3.6	1	8.8	0.5°	500
PK264 <input type="checkbox"/> 1A-SG7.2, PK264 <input type="checkbox"/> 2A-SG7.2 PK264A2AR <input type="checkbox"/> S7.2	7.2	2	17.7	0.25°	250
PK264 <input type="checkbox"/> 1A-SG9, PK264 <input type="checkbox"/> 2A-SG9 PK264A2AR <input type="checkbox"/> S9	9	2.5	22	0.2°	200
PK264 <input type="checkbox"/> 1A-SG10, PK264 <input type="checkbox"/> 2A-SG10 PK264A2AR <input type="checkbox"/> S10	10	2.7	23	0.18°	180
PK264 <input type="checkbox"/> 1A-SG18, PK264 <input type="checkbox"/> 2A-SG18 PK264A2AR <input type="checkbox"/> S18	18	3	26	0.1°	100
PK264 <input type="checkbox"/> 1A-SG36, PK264 <input type="checkbox"/> 2A-SG36 PK264A2AR <input type="checkbox"/> S36	36	4	35	0.05°	50

- Enter **A** (Single shaft) or **B** (double shaft) in the box (□) within the model name.
Enter the encoder code (**15**, **16**, **25** or **26**) in the box (□) within the model name.
- *Holding torque is the same regardless of the connection type due to the permissible torque limit of the gearhead.

Dimensions Unit = mm (in.)

The dimension of a motor with an encoder can be found on page A-19 or at www.orientalmotor.com.

Model	Mass kg (lb.)	DXF
PK264A <input type="checkbox"/> A-SG <input type="checkbox"/>	0.75 (1.7)	B092U
PK264B <input type="checkbox"/> A-SG <input type="checkbox"/>		

- Enter the winding specification in the box (□) within the model name.
Enter the gear ratio in the box (■) within the model name.
- Screws (Included)
No.8-32 UNC Length 15.8 mm (0.62 in.)...4 pieces

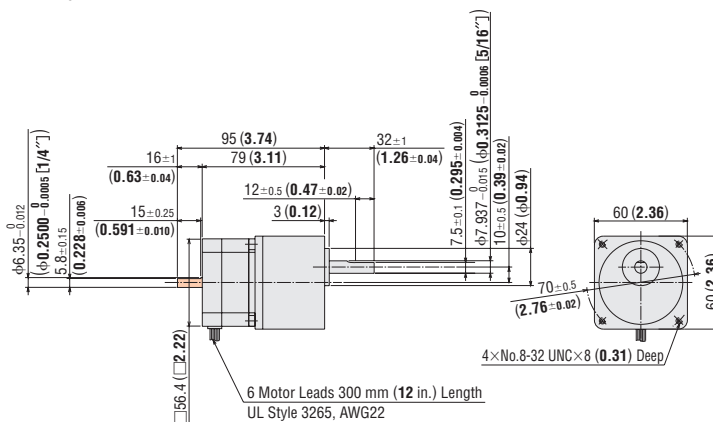

- These dimensions are for the double shaft models. For the single shaft models, ignore the orange (■) area.

Speed – Torque Characteristics

PK264 1A-SG

Bipolar (Series) 24 VDC

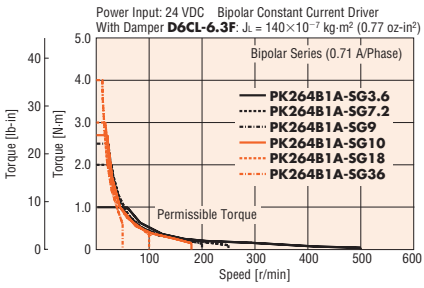

PK264 1A-SG

Unipolar

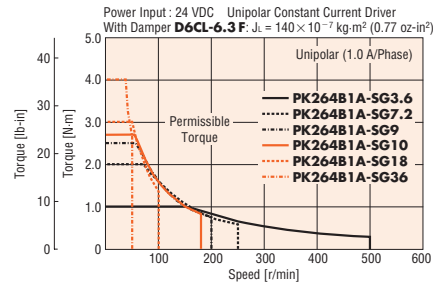

PK264 1A-SG

Bipolar (Series) 48 VDC

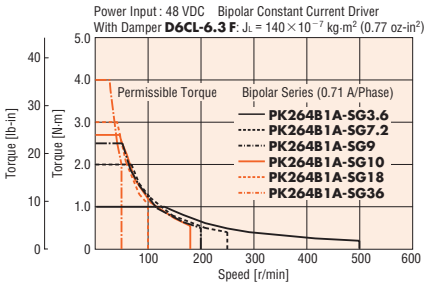

PK264 2A-SG / PK264A2AR S

Bipolar (Series) 24 VDC

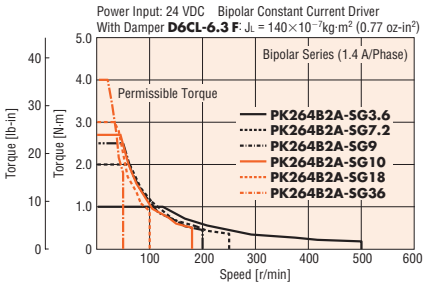

PK264 2A-SG / PK264A2AR S

Unipolar

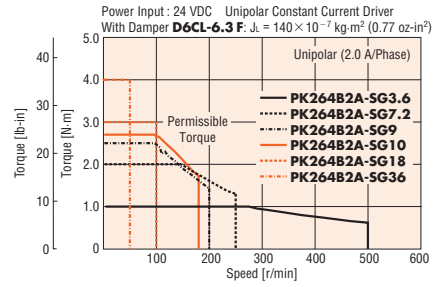

PK264 2A-SG / PK264A2AR S

Bipolar (Series) 48 VDC

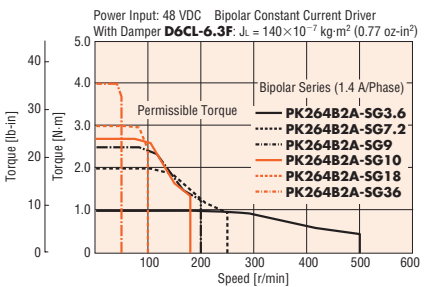

- Enter **A** (single shaft) or **B** (double shaft) in the box (□) within the model name.
- Enter the gear ratio in the box (■) within the model name.
- Enter the encoder code (**15**, **16**, **25** or **26**) in the box (□) within the model name.

Note

- Pay attention to heat dissipation from motor as there will be a considerable amount of heat under certain conditions. Be sure to keep the temperature of the motor case under 100°C (212°F).

Introduction	
AR	0.36° / Geared
AS	AC Input Motor & Driver
RK	0.72° / Geared
UMK	0.9°/1.8°
AR	0.36° / Geared
ASX	0.36° / Geared
CRK	0.36°/0.72° / Geared
CMK	0.9°/1.8° / Geared
RBK	1.8° / Geared
PK	0.36°
PK	0.72°
PK	0.9°
PK/PV	1.8°
PK	Geared
SCX10 / EMP400 / SG80301	Controllers
	Accessories

SH Geared Type

Motor Frame Size 90 mm (3.54 in.)

PK Series



20 mm (0.79 in.)
28 mm (1.10 in.)
35 mm (1.38 in.)
42 mm (1.65 in.)
50 mm (1.97 in.)
56.4 mm (2.22 in.)
60 mm (2.36 in.)
85 mm (3.35 in.)
90 mm (3.54 in.)

Specifications (RoHS)

Motor Specifications

Model • Single Shaft • Double Shaft	Connection Type	Rated Current	Voltage	Resistance	Inductance	Rotor Inertia J		Lead Wires
		A/phase	VDC	Ω/phase	mH/phase	kg·m ²	oz·in ²	
PK296A1A-SG <input type="checkbox"/> PK296B1A-SG <input type="checkbox"/>	Bipolar (Series)	1	4.4	4.4	30.8	1400×10 ⁻⁷	7.7	6
	Unipolar	1.5	3.3	2.2	7.7			
PK296A2A-SG <input type="checkbox"/> PK296B2A-SG <input type="checkbox"/>	Bipolar (Series)	2.1	2	0.96	6	1400×10 ⁻⁷	7.7	6
	Unipolar	3	1.4	0.48	1.5			

- Wiring and connections → Page A-288
Enter the gear ratio in the box () within the model name.
- Backlash value is approximately 1 to 2°.

Note

- Direction of rotation of the motor and that of the gear output shaft are the same for the gear ratios 3.6, 7.2, 9, 10 and 18.
It is opposite for 36 gear ratios.

Gearmotor Specifications

Model • Single Shaft • Double Shaft	Gear Ratio	Holding Torque*		Step Angle	Permissible Speed r/min
		N·m	lb·in		
PK296A1A-SG3.6 , PK296A2A-SG3.6 PK296B1A-SG3.6 , PK296B2A-SG3.6	3.6	2.5	22	0.5°	500
PK296A1A-SG7.2 , PK296A2A-SG7.2 PK296B1A-SG7.2 , PK296B2A-SG7.2	7.2	5	44	0.25°	250
PK296A1A-SG9 , PK296A2A-SG9 PK296B1A-SG9 , PK296B2A-SG9	9	6.3	55	0.2°	200
PK296A1A-SG10 , PK296A2A-SG10 PK296B1A-SG10 , PK296B2A-SG10	10	7	61	0.18°	180
PK296A1A-SG18 , PK296A2A-SG18 PK296B1A-SG18 , PK296B2A-SG18	18	9	79	0.1°	100
PK296A1A-SG36 , PK296A2A-SG36 PK296B1A-SG36 , PK296B2A-SG36	36	12	106	0.05°	50

*Holding torque is the same regardless of the connection type due to the permissible torque limit of the gearhead.

Dimensions Unit = mm (in.)

Model	L1	L2	Mass kg (lb.)	DXF
PK296A <input type="checkbox"/> A-SG <input type="checkbox"/>	126 (4.96)	—	2.8 (6.2)	B242U
PK296B <input type="checkbox"/> A-SG <input type="checkbox"/>		160 (6.3)		

- Enter the winding specification in the box () within the model name.
Enter the gear ratio in the box () within the model name.
- Screws (Included)
1/4-20 UNC, Length 19 mm (0.75 in.)—4 pieces

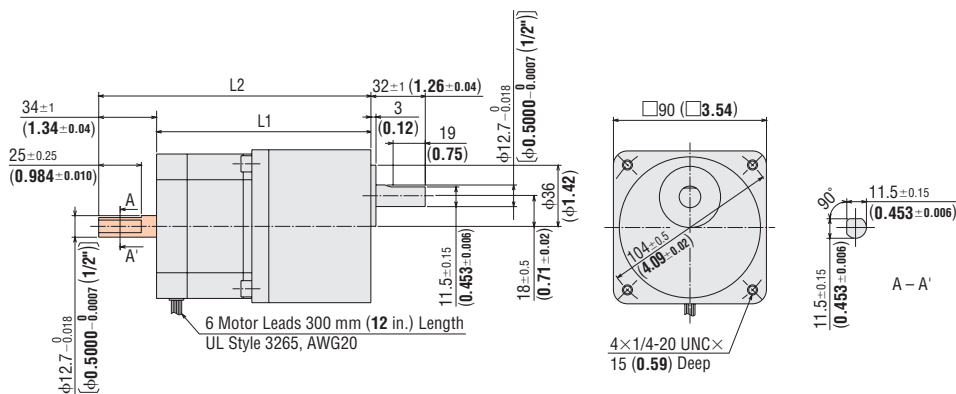

These dimensions are for the double shaft models. For the single shaft models, ignore the orange () area.

Speed – Torque Characteristics

PK296 1A-SG

Bipolar (Series) 24 VDC

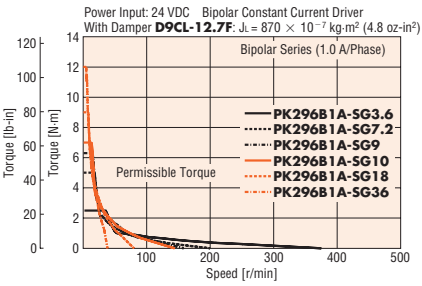

PK296 1A-SG

Unipolar

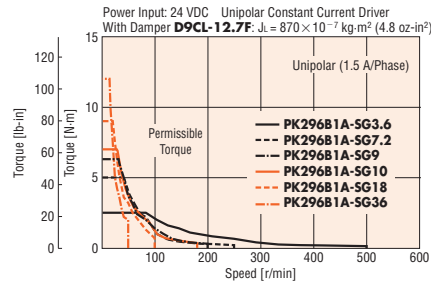

PK296 1A-SG

Bipolar (Series) 48 VDC

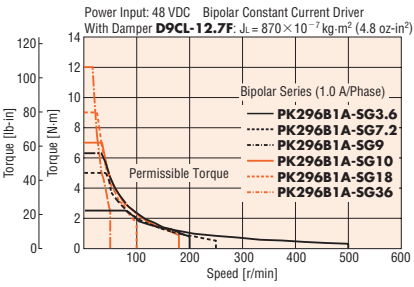

PK296 2A-SG

Bipolar (Series) 24 VDC

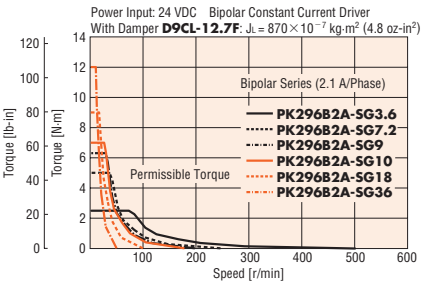

PK296 2A-SG

Unipolar

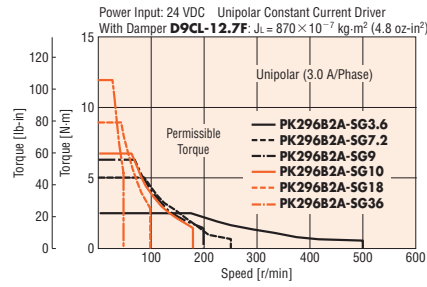

PK296 2A-SG

Bipolar (Series) 48 VDC

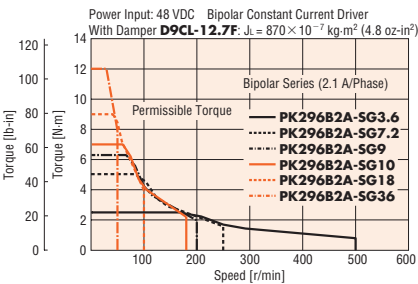

- Enter **A** (single shaft) or **B** (double shaft) in the box () within the model name.
- Enter the gear ratio in the box () within the model name.

Note

- Pay attention to heat dissipation from motor as there will be a considerable amount of heat under certain conditions. Be sure to keep the temperature of the motor case under 100°C (212°F).

Introduction	
AR	0.36° / Geared
AS	AC Input Motor & Driver
RK	0.72° / Geared
UMK	0.9°/1.8°
AR	0.36° / Geared
ASX	0.36° / Geared
CRK	0.36°/0.72° / Geared
CMK	0.9°/1.8° / Geared
RBK	1.8° / Geared
PK	0.36°
PK	0.72°
PK	0.9°
PK/PV	1.8°
PK	Geared
SCX10 / EMP400 / SG8030J	Controllers
	Accessories

TH Geared Type

Motor Frame Size 28 mm (1.10 in.), 42 mm (1.65 in.)

PK Series

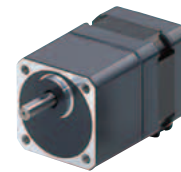

20 mm (0.79 in.)
28 mm (1.10 in.)
35 mm (1.38 in.)
42 mm (1.65 in.)
50 mm (1.97 in.)
56.4 mm (2.22 in.)
60 mm (2.36 in.)
85 mm (3.35 in.)
90 mm (3.54 in.)

Specifications

Motor Specifications (RoHS)



Motor Frame Size	Model	Connection Type	Rated Current	Rotor Inertia J		Motor Lead Wires (Pins)	Corresponding Motor & Driver Package
mm (in.)	• Single Shaft/Double Shaft • with TTL Type Encoder • with Differential Type Encoder		A/phase	kg-m ²	oz-in ²		CRK Series (Pulse/Built-In Program)
28 (1.10)	PK523P □-T□	New Pentagon (Bipolar)	0.35	9×10 ⁻⁷	0.049	5	CRK523P □P-T□ CRK523P □KP-T□
42 (1.65)	PK543 □W-T□ PK543AWR27T □ PK543AWR27LT □		0.75	35×10 ⁻⁷	0.191		CRK543 □P-T□ CRK543 □KP-T□ CRK543APR27T □ CRK543RKPT □

- Wirings and connections → Page A-288, Encoder specifications → Page A-17
- See the page for the corresponding motor and driver package for speed-torque characteristics and dimensions.
- The dimensions of a motor with an encoder can be found on page A-20.
- The motor connection cable is available as an accessory.
- Enter the encoder code (**17**, **18**, **27** or **28**) in the box (□) within the model name.
Enter the **A** (single shaft) or **B** (double shaft) in the box (□) within the model name.
Product Number Code → Page A-278

- *1 Adopted for motor frame size 28 mm (1.10 in.) products.
- *2 Adopted for motor frame size 42 mm (1.65 in.) products.
- *3 CE Marking is applied to a corresponding motor and driver package product.

Gearmotor Specifications

Model		Gear Ratio	Maximum Holding Torque		Basic Step Angle	Backlash arc minute (degrees)	Permissible Speed Range
• Single Shaft/Double Shaft	• with TTL Type Encoder • with Differential Type Encoder		N-m	PK523 : oz-in PK543 : lb-in			
PK523P □-T7.2	—	7.2	0.2	28	0.1°	60 (1)	0~416
PK523P □-T10	—	10	0.3	42	0.072°		0~300
PK523P □-T20	—	20	0.4	56	0.036°		0~150
PK523P □-T30	—	30	0.5	71	0.024°		0~100
PK543 □W-T3.6	PK543AWR27T3.6 PK543AWR27LT3.6	3.6	0.35	3	0.2°	45 (0.75)	0~500
PK543 □W-T7.2	PK543AWR27T7.2 PK543AWR27LT7.2	7.2	0.7	6.1	0.1°	25 (0.42)	0~250
PK543 □W-T10	PK543AWR27T10 PK543AWR27LT10	10	1	8.8	0.072°		0~180
PK543 □W-T20	PK543AWR27T20 PK543AWR27LT20	20	1.5	13.2	0.036°	15 (0.25)	0~90
PK543 □W-T30	PK543AWR27T30 PK543AWR27LT30	30			0.024°		0~60

- Enter **A** (single shaft) or **B** (double shaft) in the box (□) within the model name.

Introduction of Stepping Motor and Driver Packages

Stepping motor and driver packages are available. Packages are outfitted with drivers specifically designed to obtain the motor's maximum performance.

AC Input Motor and Driver Package

RK Series → Page A-78



DC Input Motor and Driver Package

CRK Series → Page A-168

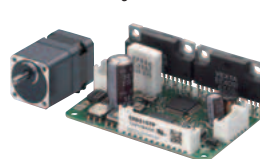

Pulse Input



Built-In Controller

TH Geared Type

Motor Frame Size 60 mm (2.36 in.), 90 mm (3.54 in.)

PK Series



Specifications

Motor Specifications



Motor Frame Size mm (in.)	Model • Single Shaft/Double Shaft • with TTL Type Encoder • with Differential Type Encoder	Connection Type	Rated Current		Rotor Inertia J		Motor Lead Wires (Pins)	Corresponding Motor & Driver Package RK Series CRK Series (Pulse/Built-In Program)
			A/phase		kg·m ²	oz·in ²		
60 (2.36)	PK564□W-T□ PK564AWR27T□ PK564AWR27LT□	New Pentagon (Bipolar)	1.4		175×10 ⁻⁷	0.96	5	CRK564□P-T□ CRK564□KP-T□ CRK564APR27T□ CRK564RKPT□
					1400×10 ⁻⁷	7.7		
90 (3.54)	PK596□E-T□ PK596□E1-T□ PK596AER27T□ PK596AE1R27T□							RK596□□E-T□ RK596A□ER27T□

- Wirings and connections → Page A-288, Encoder specifications → Page A-17
- See the page for the corresponding motor and driver package for speed-torque characteristics and dimensions.
- The dimensions of a motor with an encoder can be found on page A-20.
- Enter the **A** (single shaft) or **B** (double shaft) in the box (□) within the model name.
Enter the gear ratio in the box (□) within the model name.
Enter the **A** (single-phase 100-115 VAC) or **C** (single-phase 200-230 VAC) in the box (□) with in the model name.
- *CE Marking is applied to a corresponding motor and driver package product.

Gearmotor Specifications

Model • Single Shaft/Double Shaft • with TTL Type Encoder • with Differential Type Encoder	Gear Ratio	Maximum Holding Torque		Basic Step Angle	Backlash arc minute (degrees)	Permissible Speed Range r/min
		N·m	PK564: oz·in PK596: lb·in			
PK564□W-T3.6 PK564AWR27T3.6 PK564AWR27LT3.6	3.6	1.25	11	0.2°	35 (0.59)	0~500
PK564□W-T7.2 PK564AWR27T7.2 PK564AWR27LT7.2	7.2	2.5	22	0.1°	15 (0.25)	0~250
PK564□W-T10 PK564AWR27T10 PK564AWR27LT10	10	3	26	0.072°		0~180
PK564□W-T20 PK564AWR27T20 PK564AWR27LT20	20	3.5	30	0.036°	10 (0.17)	0~90
PK564□W-T30 PK564AWR27T30 PK564AWR27LT30	30	4	35	0.024°		0~60
PK596□E-T3.6 PK596AER27T3.6	3.6	4.5	39	0.2°	25 (0.42)	0~500
PK596□E-T7.2 PK596AER27T7.2	7.2	9	79	0.1°	15 (0.25)	0~250
PK596□E1-T10 PK596AE1R27T10	10			0.072°		0~180
PK596□E1-T20 PK596AE1R27T20	20	12	106	0.036°	10 (0.17)	0~90
PK596□E1-T30 PK596AE1R27T30	30			0.024°		0~60

- Enter **A** (single shaft) or **B** (double shaft) in the box (□) within the model name.

Introduction of Stepping Motor and Driver Packages

Stepping motor and driver packages are available. Packages are outfitted with drivers specifically designed to obtain the motor's maximum performance.

AC Input Motor and Driver Package

RK Series → Page A-78



DC Input Motor and Driver Package

CRK Series → Page A-168

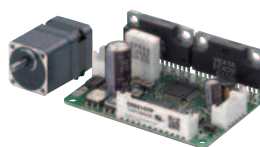

Pulse Input



Built-In Controller

Introduction
AR ^{DCSTEP} / Geared AS
0.36° / Geared / 0.72° / Geared
AC Input Motor & Driver
RK
0.9°/1.8°
UMK
0.36° / Geared / 0.72° / Geared
AR ^{DCSTEP} / Geared ASX
0.36° / Geared / 0.72° / Geared
CRK
0.9°/1.8° / Geared
CMK
1.8° / Geared
RBK
0.36° / Geared
PK
0.72° / Geared
PK
0.9° / Geared
PK
1.8° / Geared
PK/PV
Geared
PK
Controllers SCX10 EMP400 /SG8030J
Accessories

PS Geared Type

Motor Frame Size 28 mm (1.10 in.), 42 mm (1.65 in.)

PK Series



Specifications

Motor Specifications RoHS



Motor Frame Size mm (in.)	Model • Single Shaft/Double Shaft • with TTL Type Encoder • with Differential Type Encoder	Connection Type	Rated Current		Rotor Inertia J		Motor Lead Wires (Pins)	Corresponding Motor & Driver Package CRK Series (Pulse/Built-In Program)
			A/phase		kg-m ²	oz-in ²		
28 (1.10)	PK523P □- PS □	New Pentagon (Bipolar)	0.35		9×10 ⁻⁷	0.049	5	CRK523P □- P-PS □ CRK523P □- KP-PS □
42 (1.65)	PK545 □- W-PS □ PK545AWR27PS □ PK545AWR27LPS □		0.75		68×10 ⁻⁷	0.37		CRK545 □- P-PS □ CRK545 □- KP-PS □ CRK545APR27PS □ CRK545RKPPS □
	PK543 □- W-PS □ PK543AWR27PS □ PK543AWR27LPS □				35×10 ⁻⁷	0.191		CRK543 □- P-PS □ CRK543 □- KP-PS □ CRK543APR27PS □ CRK543RKPPS □

- Wirings and connections → Page A-288, Encoder specifications → Page A-17
- See the page for the corresponding motor and driver package for speed-torque characteristics and dimensions.
- The dimensions of a motor with an encoder can be found on page A-20.
- Enter the **A** (single shaft) or **B** (double shaft) in the box (□) within the model name.
A number indicating the gear ratio is entered when the box (■) is located within the model name.
- *1 Adopted for motor frame size 28 mm (1.10 in.) products.
- *2 Adopted for motor frame size 42 mm (1.65 in.) products.
- *3 CE Marking is applied to a corresponding motor and driver package product.

Gearmotor Specifications

Model		Gear Ratio	Maximum Holding Torque		Basic Step Angle	Backlash arc minute (degrees)	Permissible Speed Range r/min
• Single Shaft/Double Shaft	• with TTL Type Encoder • with Differential Type Encoder		N·m	PK52: oz-in PK54: lb-in			
PK523P □- PS5	—	5	0.2	28	0.144°	35 (0.59)	0~600
PK523P □- PS7	—	7.2	0.3	42	0.1°		0~416
PK523P □- PS10	—	10	0.4	56	0.072°		0~300
PK545 □- W-PS5	PK545AWR27PS5 PK545AWR27LPS5	5	1	8.8	0.144°	25 (0.42)	0~600
PK545 □- W-PS7	PK545AWR27PS7 PK545AWR27LPS7	7.2	1.5	13.2	0.1°		0~416
PK545 □- W-PS10	PK545AWR27PS10 PK545AWR27LPS10	10			0.072°		0~300
PK543 □- W-PS25	PK543AWR27PS25 PK543AWR27LPS25	25	2.5	22	0.0288°		0~120
PK543 □- W-PS36	PK543AWR27PS36 PK543AWR27LPS36	36	3	26	0.02°		0~83
PK543 □- W-PS50	PK543AWR27PS50 PK543AWR27LPS50	50			0.0144°		0~60

- Enter **A** (single shaft) or **B** (double shaft) in the box (□) within the model name.

Introduction of Stepping Motor and Driver Packages

Stepping motor and driver packages are available. Packages are outfitted with drivers specifically designed to obtain the motor's maximum performance.

AC Input
Motor and Driver Package

RK Series → Page A-78

DC Input
Motor and Driver Package

CRK Series → Page A-168

PS Geared Type

Motor Frame Size 60 mm (2.36 in.), 90 mm (3.54 in.)

PK Series



Specifications

Motor Specifications

Motor Frame Size mm (in.)	Model • Single Shaft/Double Shaft • with TTL Type Encoder • with Differential Type Encoder	Connection Type	Rated Current A/phase	Rotor Inertia J		Motor Lead Wires (Pins)	Corresponding Motor & Driver Package RK Series CRK Series (Pulse/Built-In Program)
				kg·m ²	oz·in ²		
60 (2.36)	PK566□W-PS□ PK566AWR27PS□ PK566AWR27LPS□	New Pentagon (Bipolar)	1.4	280×10 ⁻⁷	1.53	5	CRK566□P-PS□ CRK566□KP-PS□ CRK566APR27PS□ CRK566RKPPS□
	PK564□W-PS□ PK564AWR27PS□ PK564AWR27LPS□			175×10 ⁻⁷	0.96		CRK564□P-PS□ CRK564□KP-PS□ CRK564APR27PS□ CRK564RKPPS□
90 (3.54)	PK599□E-PS□ PK599AER27PS□		2700×10 ⁻⁷	14.8	5	RK599□E-PS□ RK599A□ER27PS□	
	PK596□E-PS□ PK596AER27PS□		1400×10 ⁻⁷	7.7		RK596□E-PS□ RK596A□ER27PS□	

- Wirings and connections → Page A-288, Encoder specifications → Page A-17
- See the page for the corresponding motor and driver package for speed-torque characteristics and dimensions.
- The dimensions of a motor with an encoder can be found on page A-20.
- Enter the **A** (single shaft) or **B** (double shaft) in the box (□) within the model name.
A number indicating the gear ratio is entered when the box (□) is located within the model name.
Enter the **A** (single-phase 100-115 VAC) or **C** (single-phase 200-230 VAC) in the box (□) with in the model name.
- *CE Marking is applied to a corresponding motor and driver package product.

Gearmotor Specifications

Model • Single Shaft/Double Shaft • with TTL Type Encoder • with Differential Type Encoder	Gear Ratio	Maximum Holding Torque		Basic Step Angle	Backlash arc minute (degrees)	Permissible Speed Range r/min
		N·m	lb·in			
PK566□W-PS5 PK566AWR27PS5 PK566AWR27LPS5	5	3.5	30	0.144°	15 (0.25)	0~600
PK566□W-PS7 PK566AWR27PS7 PK566AWR27LPS7	7.2	4	35	0.1°		0~416
PK566□W-PS10 PK566AWR27PS10 PK566AWR27LPS10	10	5	44	0.072°		0~300
PK564□W-PS25 PK564AWR27PS25 PK564AWR27LPS25	25	8	70	0.0288°		0~120
PK564□W-PS36 PK564AWR27PS36 PK564AWR27LPS36	36			0.02°		0~83
PK564□W-PS50 PK564AWR27PS50 PK564AWR27LPS50	50			0.0144°		0~60
PK599□E-PS5 PK599AER27PS5	5	14	123	0.144°		0~600
PK599□E-PS7 PK599AER27PS7	7.2	20	177	0.1°		0~416
PK599□E-PS10 PK599AER27PS10	10			0.072°		0~300
PK596□E-PS25 PK596AER27PS25	25			0.0288°		0~120
PK596□E-PS36 PK596AER27PS36	36	37	320	0.02°	0~83	
PK596□E-PS50 PK596AER27PS50	50			0.0144°	0~60	

- Enter **A** (single shaft) or **B** (double shaft) in the box (□) within the model name.

Introduction of Stepping Motor and Driver Packages

Stepping motor and driver packages are available. Packages are outfitted with drivers specifically designed to obtain the motor's maximum performance.

AC Input
Motor and Driver Package

RK Series → Page A-78

DC Input
Motor and Driver Package

CRK Series → Page A-168

PS Geared Type

Motor Frame Size 28 mm (1.10 in.)

PK Series

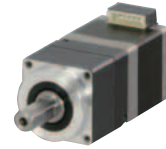

Specifications

Motor Specifications (RoHS)

Model • Single Shaft/Double Shaft • with Encoder	Connection Type	Rated Current A/phase	Voltage VDC	Resistance Ω/phase	Inductance mH/phase	Rotor Inertia J		Motor Lead Wires (Pins)	Corresponding Motor & Driver Package
						kg·m ²	oz·in ²		RBK Series
PK223PD □- PS5	Bipolar	1.5	1.8	1.2	0.74	9×10 ⁻⁷	0.049	4	RBK223P □- P-PS ■
PK223PD □- PS10									

- Wirings and connections → Page A-288
- See the page for the corresponding motor and driver package for speed-torque characteristics and dimensions.
- Enter the **A** (single shaft) or **B** (double shaft) in the box (□) within the model name.
Enter the gear ratio in the box (■) within the model name.

Note

- Direction of rotation of the motor and that of the gear output shaft are the same.

Gearmotor Specifications

Model • Single Shaft/Double Shaft • with Encoder	Gear Ratio	Holding Torque*		Maximum Torque		Basic Step Angle	Backlash arc minute (degrees)	Permissible Speed Range r/min
		N·m	oz·in	N·m	oz·in			
PK223PD □- PS5	5	0.3	42	0.5	71	0.36°	35 (0.59)	600
PK223PD □- PS10	10	0.5	71					300

* Holding torque is the same regardless of the connection type due to the permissible torque limit of the gearhead.

- Enter **A** (single shaft) or **B** (double shaft) in the box (□) within the model name.

Dimensions Unit = mm (in.)

Model	Mass kg (lb.)	DXF
PK223PDA-PS ■	0.11	B975
PK223PDB-PS ■	(0.24)	

- Enter the gear ratio in the box (■) within the model name.
- Lead wires are not supplied with the connector-coupled motor and must be purchased separately.
The connection cable is available as an accessory (sold separately).
- Applicable Connector
Connector housing: 51065-0600 (MOLEX)
Contact: 50212-8100 (MOLEX)
Crimp tool: 57176-5000 (MOLEX)

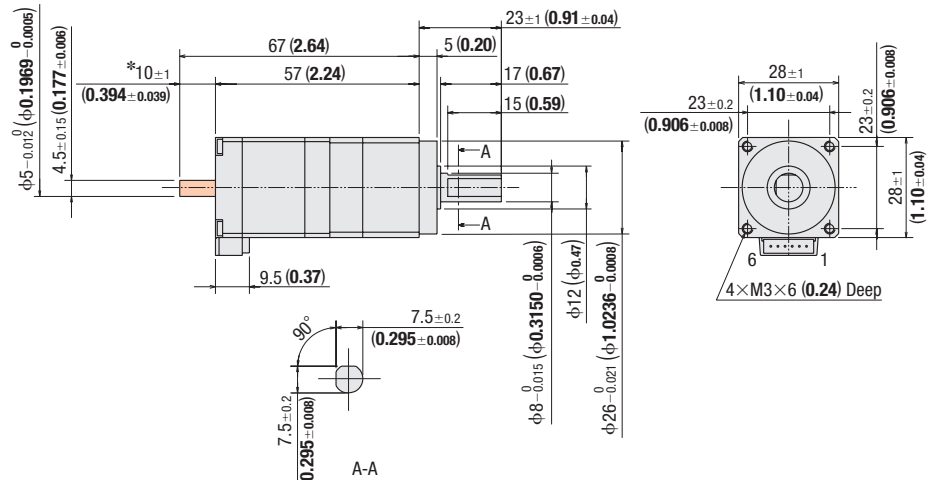

* The length of machining on the double shaft model is 10±0.25 (0.394±0.010).

- These dimensions are for the double shaft models. For the single shaft models, ignore the orange (■) area.

Speed – Torque Characteristics

PK223PD

Bipolar 24 VDC

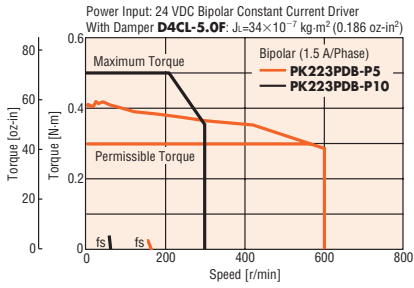

PK223PD

Bipolar 36 VDC

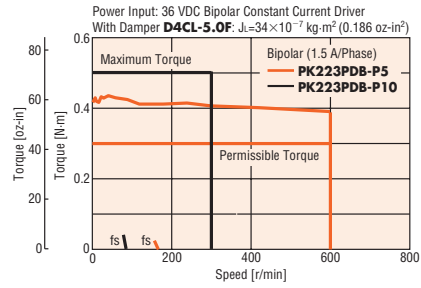

Note

- Pay attention to heat dissipation from motor as there will be a considerable amount of heat under certain conditions. Be sure to keep the temperature of the motor case under 100°C (212°F).

Accessories (Sold separately)

The connection cable is available as an accessory.

- Connection Cable → Page A-409

Introduction	
AR	DC Input Motor & Driver
AS	0.36° / Geared / 0.72° / Geared
UMK	0.9°/1.8°
AR	0.36° / Geared / 0.72° / Geared
ASX	DC Input Motor & Driver
CRK	0.36° / Geared / 0.72° / Geared
CMK	0.9°/1.8° / Geared
RBK	1.8° / Geared
PK	0.36°
PK	0.72°
PK	0.9°
PK/PV	1.8°
PK	Geared
SCX10 / EMP400 / SG8030J	Controllers
	Accessories

PL Geared Type

Motor Frame Size 42 mm (1.65 in.)

PK Series



Specifications

Motor Specifications RoHS

Model • Single Shaft/Double Shaft • with Encoder	Connection Type	Rated Current A/phase	Voltage VDC	Resistance Ω/phase	Inductance mH/phase	Rotor Inertia J		Motor Lead Wires (Pins)	Corresponding Motor & Driver Package RBK Series
						kg·m ²	oz·in ²		
PK244PD <input type="checkbox"/> - P5 PK244PDAR <input type="checkbox"/> - P5	Bipolar	1.5	2.14	1.43	1.5	57×10 ⁻⁷	0.31	4	RBK244P <input type="checkbox"/> - P <input type="checkbox"/> RBK244PAR <input type="checkbox"/> - P <input type="checkbox"/>
PK244PD <input type="checkbox"/> - P10 PK244PDAR <input type="checkbox"/> - P10									
PK244PD <input type="checkbox"/> - P36 PK244PDAR <input type="checkbox"/> - P36			1.2	0.8	0.47				

● Wirings and Connections → Page A-288

Encoder Specifications → Page A-17

- Enter **A** (single shaft) or **B** (double shaft) in the box () within the model name.
- Enter the encoder code (**15**, **16**, **25** or **26**) in the box () within the model name.
- Enter the gear ratio in the box () within the model name.
- Product Number Code → Page A-278

Note

- Direction of rotation of the motor and that of the gear output shaft are the same.

Gearmotor Specifications

Model • Single Shaft/Double Shaft • with Encoder	Gear Ratio	Holding Torque*		Basic Step Angle	Backlash arc minute (degrees)	Permissible Speed Range r/min
		N·m	lb·in			
PK244PD <input type="checkbox"/> - P5 PK244PDAR <input type="checkbox"/> - P5	5	1	8.8	0.36°	35 (0.59)	360
PK244PD <input type="checkbox"/> - P10 PK244PDAR <input type="checkbox"/> - P10	10	1.5	13.2	0.18°		180
PK244PD <input type="checkbox"/> - P36 PK244PDAR <input type="checkbox"/> - P36	36	3	26	0.05°		50

*Holding torque is the same regardless of the connection type due to the permissible torque limit of the gearhead.

- Enter **A** (single shaft) or **B** (double shaft) in the box () within the model name.
- Enter the encoder code (**15**, **16**, **25** or **26**) in the box () within the model name.

20 mm
(0.79 in.)

28 mm
(1.10 in.)

35 mm
(1.38 in.)

42 mm
(1.65 in.)

50 mm
(1.97 in.)

56.4 mm
(2.22 in.)

60 mm
(2.36 in.)

85 mm
(3.35 in.)

90 mm
(3.54 in.)

Dimensions Unit = mm (in.)

The dimension of a motor with an encoder can be found on page A-19 or at www.orientalmotor.com.

Model	L1	L2	Mass kg (lb.)	DXF
PK244PDA-P5	66.5 (2.62)	—	0.48 (1.06)	B331
PK244PDB-P5		81.5 (3.21)		
PK244PDA-P10		—		
PK244PDB-P10	81.5 (3.21)			
PK244PDA-P36	90 (3.54)	—	0.6 (1.32)	
PK244PDB-P36		105 (4.13)		

- Lead wire and connector are not supplied with the connector-coupled motor and must be purchased separately. The connection cable is available as an accessory (sold separately).
- Applicable Connector
Connector housing: 51103-0600 (MOLEX)
Contact: 50351-8100 (MOLEX)
Crimp tool: 57295-5000 (MOLEX)

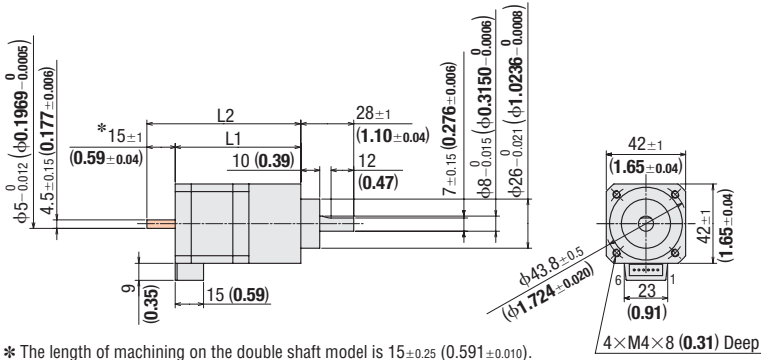

- These dimensions are for the double shaft models. For the single shaft models, ignore the orange () area.

Speed – Torque Characteristics

PK244PD

Bipolar 24 VDC

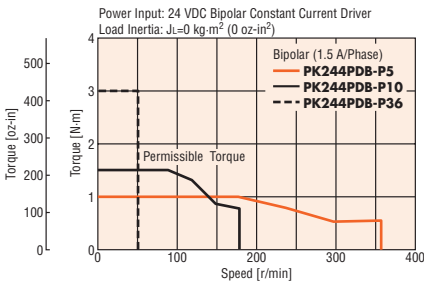

PK244PD

Bipolar 36 VDC

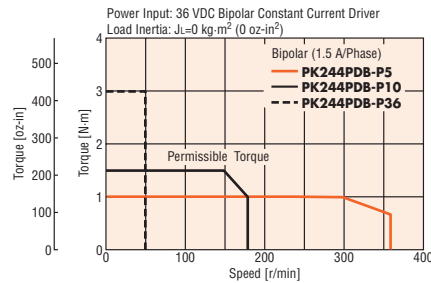

Note

- Pay attention to heat dissipation from motor as there will be a considerable amount of heat under certain conditions. Be sure to keep the temperature of the motor case under 100°C (212°F).

Accessories (Sold separately)

The connection cable is available as an accessory.

- Connection Cable → Page A-409

Introduction	
AR	0.36° / Geared
AS	0.72° / Geared
RK	0.9° / 1.8°
UMK	0.36° / Geared
AR	0.36° / Geared
ASX	0.36° / Geared
CRK	0.36° / 0.72° / Geared
CMK	0.9° / 1.8° / Geared
RBK	1.8° / Geared
PK	0.36°
PK	0.72°
PK	0.9°
PK/PV	1.8°
PK	Geared
SCX10 / EMP400 / SG8030J	Controllers
	Accessories

PL Geared Type

Motor Frame Size 60 mm (2.36 in.)

PK Series



Specifications

Motor Specifications RoHS

Model	Connection Type	Rated Current	Voltage	Resistance	Inductance	Rotor Inertia J		Motor Lead Wires (Pins)	Corresponding Motor & Driver Package
• Single Shaft/Double Shaft • with Encoder		A/phase	VDC	Ω /phase	mH/phase	kg·m ²	oz·in ²		RBK Series
PK266PD <input type="checkbox"/> - P5 PK266PDAR <input type="checkbox"/> - P5	Bipolar	2.8	1.62	0.58	0.97	290×10 ⁻⁷	1.59	4	RBK266P <input type="checkbox"/> - P <input type="checkbox"/> RBK264P <input type="checkbox"/> - P <input type="checkbox"/> RBK266PAR <input type="checkbox"/> - P <input type="checkbox"/> RBK264PAR <input type="checkbox"/> - P <input type="checkbox"/>
PK266PD <input type="checkbox"/> - P10 PK266PDAR <input type="checkbox"/> - P10			1.29	0.46	0.73	120×10 ⁻⁷	0.66		
PK264PD <input type="checkbox"/> - P36 PK264PDAR <input type="checkbox"/> - P36									

● Wirings and Connections → Page A-288

Encoder Specifications → Page A-17

- Enter **A** (single shaft) or **B** (double shaft) in the box () within the model name.
- Enter the encoder code (**15**, **16**, **25** or **26**) in the box () within the model name.
- Enter the gear ratio in the box () within the model name.
- Product Number Code → Page A-278

Note

- Direction of rotation of the motor and that of the gear output shaft are the same.

Gearmotor Specifications

Model	Gear Ratio	Holding Torque*		Basic Step Angle	Backlash arc minute (degrees)	Permissible Speed Range
		N·m	lb·in			
PK266PD <input type="checkbox"/> - P5 PK266PDAR <input type="checkbox"/> - P5	5	3.5	30	0.36°	20 (0.33)	360
PK266PD <input type="checkbox"/> - P10 PK266PDAR <input type="checkbox"/> - P10	10	5	44	0.18°		180
PK264PD <input type="checkbox"/> - P36 PK264PDAR <input type="checkbox"/> - P36	36	8	70	0.05°		50

*Holding torque is the same regardless of the connection type due to the permissible torque limit of the gearhead.

- Enter **A** (single shaft) or **B** (double shaft) in the box () within the model name.
- Enter the encoder code (**15**, **16**, **25** or **26**) in the box () within the model name.

20 mm
(0.79 in.)

28 mm
(1.10 in.)

35 mm
(1.38 in.)

42 mm
(1.65 in.)

50 mm
(1.97 in.)

56.4 mm
(2.22 in.)

60 mm
(2.36 in.)

85 mm
(3.35 in.)

90 mm
(3.54 in.)

Dimensions Unit = mm (in.)

The dimension of a motor with an encoder can be found on page A-19 or at www.orientalmotor.com.

Model	L1	L2	Mass kg (lb.)	DXF
PK266PDA-P5	89 (3.5)	—	1.23 (2.71)	B715
PK266PDB-P5		112 (4.41)		
PK266PDA-P10		—		
PK266PDB-P10		112 (4.41)		
PK264PDA-P36	99 (3.9)	—	1.26 (2.77)	B716
PK264PDB-P36		122 (4.8)		

- Lead wire and connector are not supplied with the connector-coupled motor and must be purchased separately. The connection cable is available as an accessory (sold separately).
- Applicable Connector
Connector housing: 51067-0600 (MOLEX)
Contact: 50217-9101 (MOLEX)
Crimp tool: 57189-5000 (MOLEX)

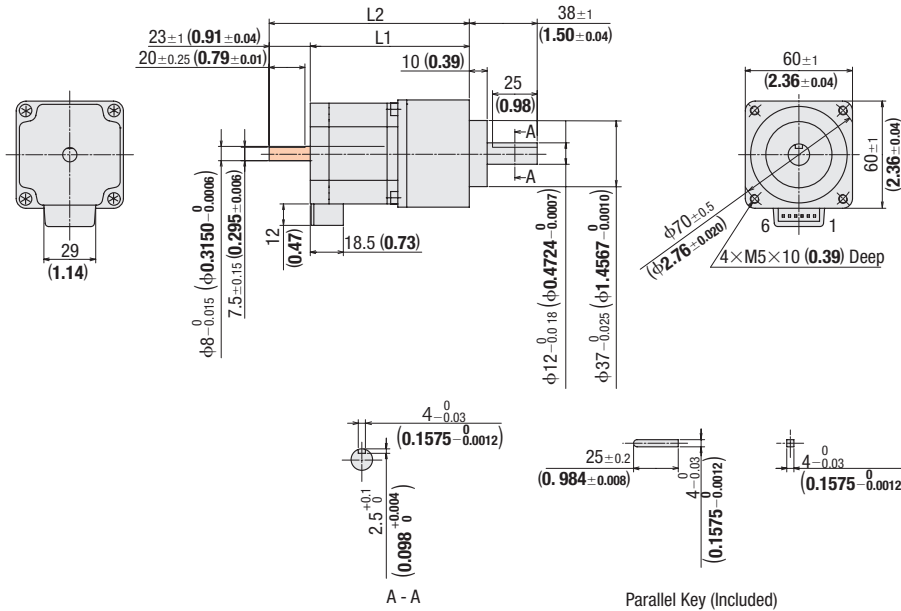

- These dimensions are for the double shaft models. For the single shaft models, ignore the orange area.

Speed – Torque Characteristics

PK266PD/PK264PD

Bipolar 24 VDC

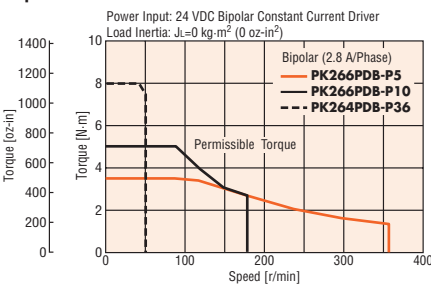

Note

- Pay attention to heat dissipation from motor as there will be a considerable amount of heat under certain conditions. Be sure to keep the temperature of the motor case under 100°C (212°F).

Accessories (Sold separately)

The connection cable is available as an accessory.

- Connection Cable → A-409

PK266PD/PK264PD

Bipolar 36 VDC

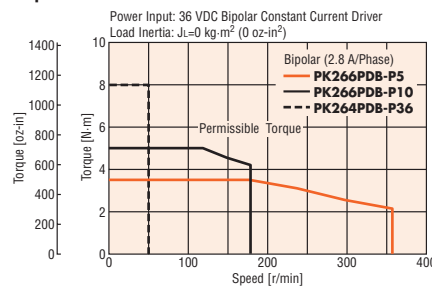

20 mm
(0.79 in.)

28 mm
(1.10 in.)

35 mm
(1.38 in.)

42 mm
(1.65 in.)

50 mm
(1.97 in.)

56.4 mm
(2.22 in.)

60 mm
(2.36 in.)

85 mm
(3.35 in.)

90 mm
(3.54 in.)

PN Geared Type

Motor Frame Size 28 mm (1.10 in.), 42 mm (1.65 in.)

PK Series



Specifications

Motor Specifications RoHS



Motor Frame Size mm (in.)	Model •Single Shaft/Double Shaft	Connection Type	Rated Current A/phase	Rotor Inertia J kg-m ² oz-in ²		Motor Lead Wires (Pins)	Corresponding Motor & Driver Package CRK Series (Pulse/Built-in Program)
28 (1.10)	PK523P <input type="checkbox"/> - N <input type="checkbox"/>	New Pentagon (Bipolar)	0.35	9×10 ⁻⁷	0.049	5	CRK523P <input type="checkbox"/> - P-N <input type="checkbox"/>
42 (1.65)	PK544 <input type="checkbox"/> - W-N <input type="checkbox"/>		0.75	54×10 ⁻⁷	0.3		CRK544 <input type="checkbox"/> - P-N <input type="checkbox"/>

- Wirings and connections → Page A-288
Encoder specifications → Page A-17
- See the page for the corresponding motor and driver package for speed-torque characteristics and dimensions.
- The dimensions of a motor with an encoder can be found on page A-20.
- The motor connection cable is available as an accessory.
- Enter the **A** (single shaft) or **B** (double shaft) in the box () within the model name.
Enter the gear ratio in the box () within the model name.
Product Number Code → Page A-278
- *1 Adopted for motor frame size 28 mm (1.10 in.) products.
- *2 Adopted for motor frame size 42 mm (1.65 in.) products.
- *3 CE Marking is applied to a corresponding motor and driver package product.

Gearmotor Specifications

Model •Single Shaft/Double Shaft	Gear Ratio	Maximum Holding Torque		Basic Step Angle	Backlash arc minute (degrees)	Permissible Speed Range r/min
		N-m	PK523 : oz-in PK544 : lb-in			
PK523P <input type="checkbox"/> - N5	5	0.2	28	0.144°	3 (0.05)	0~600
PK523P <input type="checkbox"/> - N7.2	7.2	0.3	42	0.1°		0~416
PK523P <input type="checkbox"/> - N10	10	0.4	56	0.072°		0~300
PK544 <input type="checkbox"/> - W-N5	5	0.8	7	0.144°	2 (0.034)	0~600
PK544 <input type="checkbox"/> - W-N7.2	7.2	1.2	10.6	0.1°		0~416
PK544 <input type="checkbox"/> - W-N10	10	1.5	13.2	0.072°		0~300

- Enter **A** (single shaft) or **B** (double shaft) in the box () within the model name.

Introduction of Stepping Motor and Driver Packages

Stepping motor and driver packages are available. Packages are outfitted with drivers specifically designed to obtain the motor's maximum performance.

AC Input Motor and Driver Package

CRK Series → Page A-78



DC Input Motor and Driver Package

CRK Series → Page A-168



Pulse Input



Built-In Controller

PN Geared Type

Motor Frame Size 60 mm (2.36 in.), 90 mm (3.54 in.)

PK Series

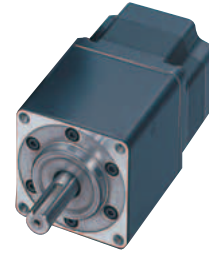

Specifications

Motor Specifications



Motor Frame Size mm (in.)	Model •Single Shaft/Double Shaft	Connection Type	Rated Current A/phase	Rotor Inertia J kg·m ² oz·in ²	Motor Lead Wires (Pins)	Corresponding Motor & Driver Package RK Series CRK Series (Pulse/Built-In Program)
60 (2.36)	PK566 <input type="checkbox"/> W-N <input type="checkbox"/>	New Pentagon (Bipolar)	1.4	280×10 ⁻⁷ 1.53	5	CRK566 <input type="checkbox"/> P-N <input type="checkbox"/>
	PK564 <input type="checkbox"/> W-N <input type="checkbox"/>			175×10 ⁻⁷ 0.96		CRK564 <input type="checkbox"/> P-N <input type="checkbox"/>
90 (3.54)	PK599 <input type="checkbox"/> E-N <input type="checkbox"/>			2700×10 ⁻⁷ 14.8		RK599 <input type="checkbox"/> E-N <input type="checkbox"/>
	PK596 <input type="checkbox"/> E-N <input type="checkbox"/>			1400×10 ⁻⁷ 7.7		RK596 <input type="checkbox"/> AE-N <input type="checkbox"/>

- Wirings and connections → Page A-288
Encoder specifications → Page A-17
- See the page for the corresponding motor and driver package for speed-torque characteristics and dimensions.
- The dimensions of a motor with an encoder can be found on page A-20.
- Enter the **A** (single shaft) or **B** (double shaft) in the box () within the model name.
Enter the gear ratio in the box () within the model name.
Enter the **A** (single-phase 100-115 VAC) or **C** (single-phase 200-230 VAC) in the box () with in the model name.
- ※CE Marking is applied to a corresponding motor and driver package product.

Gearmotor Specifications

Model •Single Shaft/Double Shaft	Gear Ratio	Maximum Holding Torque		Basic Step Angle	Backlash arc minute (degrees)	Permissible Speed Range r/min
		N-m	lb-in			
PK566 <input type="checkbox"/> W-N5	5	3.5	30	0.144°	2 (0.034)	0~600
PK566 <input type="checkbox"/> W-N7.2	7.2	4	35	0.1°		0~416
PK566 <input type="checkbox"/> W-N10	10	5	44	0.072°	3 (0.05)	0~300
PK564 <input type="checkbox"/> W-N25	25	8	70	0.0288°		0~120
PK564 <input type="checkbox"/> W-N36	36			0.02°		0~83
PK564 <input type="checkbox"/> W-N50	50			0.0144°		0~60
PK599 <input type="checkbox"/> E-N5	5			14	123	0.144°
PK599 <input type="checkbox"/> E-N7.2	7.2	20	177	0.1°	0~416	
PK599 <input type="checkbox"/> E-N10	10	37	320	0.072°	3 (0.05)	0~300
PK596 <input type="checkbox"/> E-N25	25			0.0288°		0~120
PK596 <input type="checkbox"/> E-N36	36			0.02°		0~83
PK596 <input type="checkbox"/> E-N50	50			0.0144°		0~60

- Enter **A** (single shaft) or **B** (double shaft) in the box () within the model name.

Introduction of Stepping Motor and Driver Packages

Stepping motor and driver packages are available. Packages are outfitted with drivers specifically designed to obtain the motor's maximum performance.

AC Input Motor and Driver Package

RK Series → Page A-78



DC Input Motor and Driver Packages

CRK Series → Page A-168

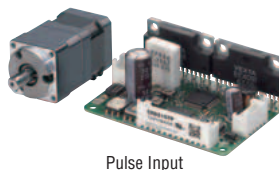

Introduction	AC Input Motor & Driver	DC Input Motor & Driver	Motor Only	Controllers	Accessories
AR	AS	AR	ASX	SCX10	
0.36° / Geared	0.72° / Geared	0.36° / Geared	0.36° / Geared	EMP400	
0.9° / 1.8°	0.9° / 1.8°	0.36° / Geared	0.9° / 1.8°	5G8030J	
1.8° / Geared	1.8° / Geared	0.36°	1.8°		
		0.72°	PK / PV		
		0.9°	PK		
		1.8°	PK		
		Geared	PK		

20 mm
(0.79 in.)

28 mm
(1.10 in.)

35 mm
(1.38 in.)

42 mm
(1.65 in.)

50 mm
(1.97 in.)

56.4 mm
(2.22 in.)

60 mm
(2.36 in.)

85 mm
(3.35 in.)

90 mm
(3.54 in.)

Harmonic Geared Type

Motor Frame Size 20 mm (0.79 in.), 30 mm (1.18 in.), 42 mm (1.65 in.)

PK Series



Specifications

Motor Specifications (RoHS)



Motor Frame Size mm (in.)	Model • Single Shaft/Double Shaft • with Encoder	Connection Type	Rated Current A/phase	Rotor Inertia J		Motor Lead Wires (Pins)	Corresponding Motor & Driver Package
				kg·m ²	oz·in ²		CRK Series (Pulse/Built-in Program)
20 (0.79)	PK513P □-H□S	New Pentagon (Bipolar)	0.35	2.1 × 10 ⁻⁷	0.0115	5	CRK513P □P-H□ CRK513P □KP-H□
30 (1.18)	PK523HP □-H□S			12 × 10 ⁻⁷	0.066		CRK523P □P-H□ CRK523P □KP-H□
42 (1.65)	PK543 □W-H□S PK543AWR27H □ PK543AWR27LH □		0.75	52 × 10 ⁻⁷	0.28		CRK543 □P-H□ CRK543 □KP-H□ CRK543APR27H □ CRK543RKP □

- Wirings and connections → Page A-288
Encoder specifications → Page A-17
- See the page for the corresponding motor and driver package for speed-torque characteristics and dimensions.
- The dimensions of a motor with an encoder can be found on page A-20.
- Enter the **A** (single shaft) or **B** (double shaft) in the box (□) within the model name.
Enter the gear ratio in the box (■) within the model name.
- *1 Adopted for motor frame size 20 mm (0.79 in.) and 28 mm (1.10 in.) products.
- *2 Adopted for motor frame size 42 mm (1.65 in.) products.
- *3 CE Marking is applied to a corresponding motor and driver package product.

Gearmotor Specifications

Model • Single Shaft/Double Shaft	• with TTL Type Encoder • with Differential Type Encoder	Gear Ratio	Maximum Holding Torque		Basic Step Angle	Lost Motion (Load torque) arc minute (degrees)	Permissible Speed Range r/min
			N·m	lb·in			
PK513P □-H50S	—	50	0.4	3.5	0.0144°	2 max. (±0.02 N·m)	0~90
PK513P □-H100S	—	100	0.6	5.3	0.0072°	2 max. (±0.03 N·m)	0~45
PK523HP □-H50S	—	50	1.8	15.9	0.0144°	1.5 max. (±0.09 N·m)	0~70
PK523HP □-H100S	—	100	2.4	21	0.0072°	1.5 max. (±0.12 N·m)	0~35
PK543 □W-H50S	PK543AWR27H50 PK543AWR27LH50	50	3.5	30	0.0144°	1.5 max. (±0.16 N·m)	0~70
PK543 □W-H100S	PK543AWR27H100 PK543AWR27LH100	100	5	44	0.0072°	1.5 max. (±0.2 N·m)	0~35

- Enter **A** (single shaft) or **B** (double shaft) in the box (□) within the model name.

Introduction of Stepping Motor and Driver Packages

Stepping motor and driver packages are available. Packages are outfitted with drivers specifically designed to obtain the motor's maximum performance.

AC Input Motor and Driver Package

RK Series → Page A-78



DC Input Motor and Driver Package

CRK Series → Page A-168



Pulse Input



Built-In Controller

Harmonic Geared Type

Motor Frame Size 60 mm (2.36 in.), 90 mm (3.54 in.)

PK Series



Specifications

Motor Specifications



Motor Frame Size mm (in.)	Model • Single Shaft/Double Shaft • with Encoder	Connection Type	Rated Current A/phase	Rotor Inertia J kg-m ² oz-in ²		Motor Lead Wires (Pins)	Corresponding Motor & Driver Package RK Series CRK Series (Pulse/Built-In Program)
60 (2.36)	PK564 <input type="checkbox"/> W-H <input type="checkbox"/> S	New Pentagon (Bipolar)	1.4	210×10 ⁻⁷	1.15	5	CRK564 <input type="checkbox"/> P-H <input type="checkbox"/> CRK564 <input type="checkbox"/> KP-H <input type="checkbox"/> CRK564 APR27H <input type="checkbox"/> CRK564 RKPH <input type="checkbox"/>
	PK564 AWR27H <input type="checkbox"/> PK564 AWR27LH <input type="checkbox"/>						CRK564 <input type="checkbox"/> E-PS <input type="checkbox"/> RK596A <input type="checkbox"/> ER27PS <input type="checkbox"/>
90 (3.54)	PK596 <input type="checkbox"/> E1-H <input type="checkbox"/> PK596 AE1R27H <input type="checkbox"/>			1600×10 ⁻⁷	8.8		

- Wirings and connections → Page A-288
Encoder specifications → Page A-17
- See the page for the corresponding motor and driver package for speed-torque characteristics and dimensions.
- The dimensions of a motor with an encoder can be found on page A-20.
- Enter the **A** (single shaft) or **B** (double shaft) in the box () within the model name.
Enter the gear ratio in the box () within the model name.
Enter the **A** (single-phase 100-115 VAC) or **C** (single-phase 200-230 VAC) in the box () with in the model name.
- *CE Marking is applied to a corresponding motor and driver package product.

Gearmotor Specifications

Model • Single Shaft/Double Shaft • with TTL Type Encoder • with Differential Type Encoder		Gear Ratio	Maximum Holding Torque		Basic Step Angle	Lost Motion (Load torque) arc minute (degrees)	Permissible Speed Range r/min
			N-m	lb-in			
PK564 <input type="checkbox"/> W-H50S	PK564 AWR27H50 PK564 AWR27LH50	50	5.5	48	0.0144°	0.7 max. (±0.28 N-m)	0~70
PK564 <input type="checkbox"/> W-H100S	PK564 AWR27H100 PK564 AWR27LH100	100	8	70	0.0072°	0.7 max. (±0.39 N-m)	0~35
PK596 <input type="checkbox"/> E1-H50	PK596 AE1R27H50	50	25	220	0.0144°	1.5 max. (±1.2 N-m)	0~70
PK596 <input type="checkbox"/> E1-H100	PK596 AE1R27H100	100	37	320	0.0072°		0~35

- Enter **A** (single shaft) or **B** (double shaft) in the box () within the model name.

Introduction of Stepping Motor and Driver Packages

Stepping motor and driver packages are available. Packages are outfitted with drivers specifically designed to obtain the motor's maximum performance.

AC Input Motor and Driver Package

RK Series → Page A-78



DC Input Motor and Driver Package

CRK Series → Page A-168

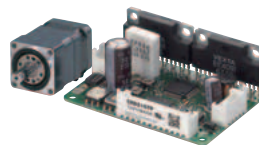

Pulse Input



Built-In Controller

Introduction	
AC Input Motor & Driver	0.36° / Geared / Driver RK / 0.72° / Geared
DC Input Motor & Driver	0.9° / 1.8° / Geared / Driver UMK / 0.36° / Geared / Driver ASX / 0.36° / Geared / Driver CRK / 0.36° / 0.72° / Geared / Driver CMK / 0.9° / 1.8° / Geared / Driver RBK / 1.8° / Geared / Driver
Motor Only	PK / 0.36° PK / 0.72° PK / 0.9° PK / PV / 1.8°
Geared	PK
Controllers	SCX10 / EMP400 / SG8030J
Accessories	

General Specifications

Item	Motor	
Thermal Class	130 (B) [Step angle 1.8° Standard type terminal box: Recognized as Class 105 (A) by UL/CSA Standards]	
Insulation Resistance	100MΩ or more when 500 VDC megger is applied between the windings and the case under normal ambient temperature and humidity.	
Dielectric Strength	<ul style="list-style-type: none"> ● Step Angle 0.36°/0.72° Stepping Motors Sufficient to withstand 1.5 kVAC at 60Hz applied between the windings and the case for 1 minute, under normal ambient temperature and humidity. 0.5 kVAC: PK51, PK52, PK54PM, PK54P 1.0 kVAC: PK54, PK56PM ● Step Angle 0.9°/1.8° Stepping Motors Sufficient to withstand 1.5 kVAC at 60Hz applied between the windings and the case for 1 minute, under normal ambient temperature and humidity. 0.5 kVAC: PK223, PK24 	
Operating Environment	Ambient Temperature	-10~+50°C (+14~+122°F) (non-freezing) 0~+40°C (+32~+104°F) (non-freezing): Harmonic geared type
	Ambient Humidity	85% or less (non-condensing)
	Atmosphere	No corrosive gasses, dust, water or oil (Standard type terminal box: no corrosive gasses and oil)
Temperature Rise	Temperature rise of windings is 80°C (144°F) or less measured by the resistance change method. (at rated voltage, at standstill, two phases excited)	
Stop Position Accuracy*1	<ul style="list-style-type: none"> ±3 arc minutes (±0.05°): PK Series ±10 arc minutes (±0.17°): PK513 ±2 arc minutes (±0.034°): Step angle 0.36° High-torque type, PV Series ±5 arc minutes (±0.083°): PK213P 	
Shaft Runout	0.05 mm (0.002 in.) T.I.R.*4	
Radial Play*2	0.025 mm (0.001 in.) maximum of 5 N (1.12 lb.)	
Axial Play*3	0.075 mm (0.003 in.) maximum of 10 N (2.2 lb.)	
Concentricity	0.075 mm (0.003 in.) T.I.R.*4	
Perpendicularity	0.075 mm (0.003 in.) T.I.R.*4	

*1 This value is for full step under no load. (The value changes with the size of the load.)

*2 Radial Play: Displacement in shaft position in the radial direction, when a 5 N (1.12 lb.) load is applied in the vertical direction to the tip of the motor's shaft.

*3 Axial Play: Displacement in shaft position in the axial direction, when a 10 N (2.2 lb.) load is applied to the motor's shaft in the axial direction.

*4 T.I.R. (Total Indicator Reading): The total dial gauge reading when the measurement section is rotated one revolution centered on the reference axis center.

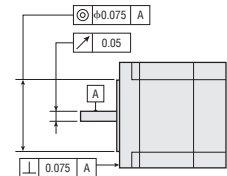

Encoder Overhung Load and Permissible Thrust Load

→ Page A-15

Encoder Specifications

→ Page A-17