



# Servo Motors



<b>Introduction</b>	..... B-2
<b>NX Series</b>	..... B-9
<b>Accessories</b>	..... B-47

<b>Introduction</b>
<b>NX</b>
<b>Accessories</b>

# Overview of Servo Motors

The servo motor is specialized for high-response, high-precision positioning. As a motor capable of accurate rotation angle and speed control, it can be used for a variety of equipment.

## ■ Features

### ● Closed Loop Control

A rotation detector (encoder) is mounted on the motor and feeds the rotation position/speed of the motor shaft back to the driver.

The driver calculates the error of the pulse signal or analog voltage (position command/speed command) from the controller and the feedback signal (current position/speed) and controls the motor rotation so the error becomes zero.

The closed loop control method is achieved with a driver, motor and encoder, so the motor can carry out highly accurate positioning operations.

- An END signal is obtained that communicates the completion of the positioning operation.

- An alarm can be output if there is an abnormality such as an overload, making it possible to communicate equipment abnormalities.

Structure of Servo Motors → Page G-51

### ◇ Position Control Using a Pulse Signal

The controller inputs the pulse signal. The speed and stop position are then controlled according to the pulse number.

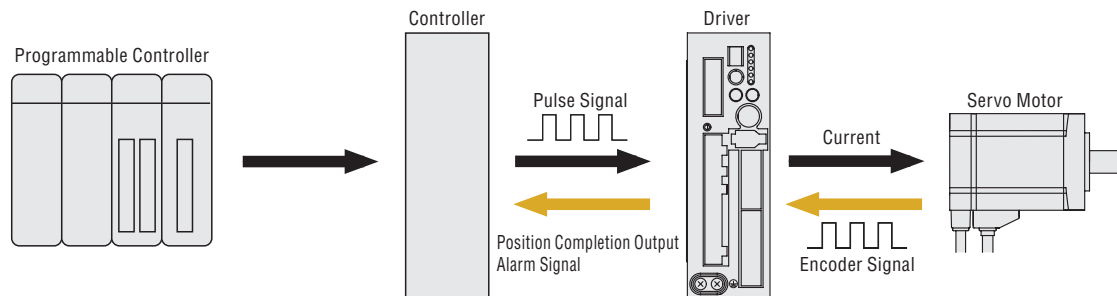

### ● Position Control Diagram

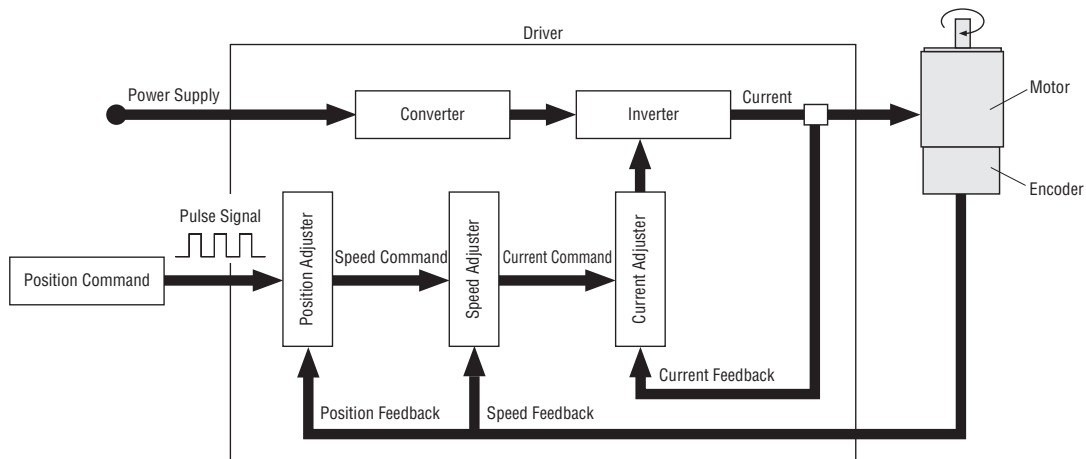

◇ **Speed Control by Analog Voltage**  
The analog voltage is input to control the speed.

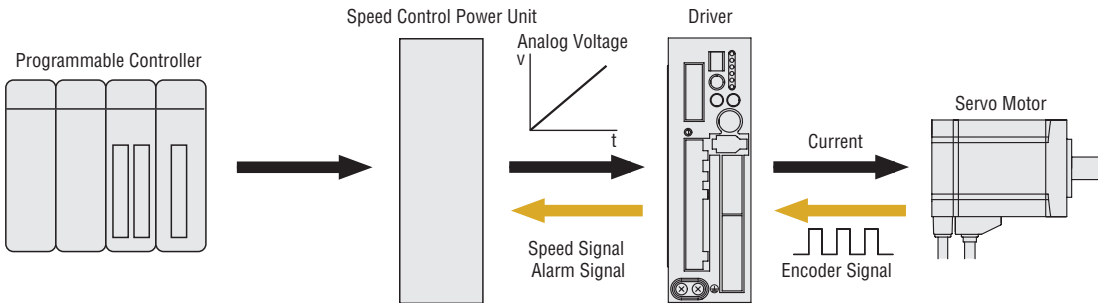

• **Speed Control Diagram**

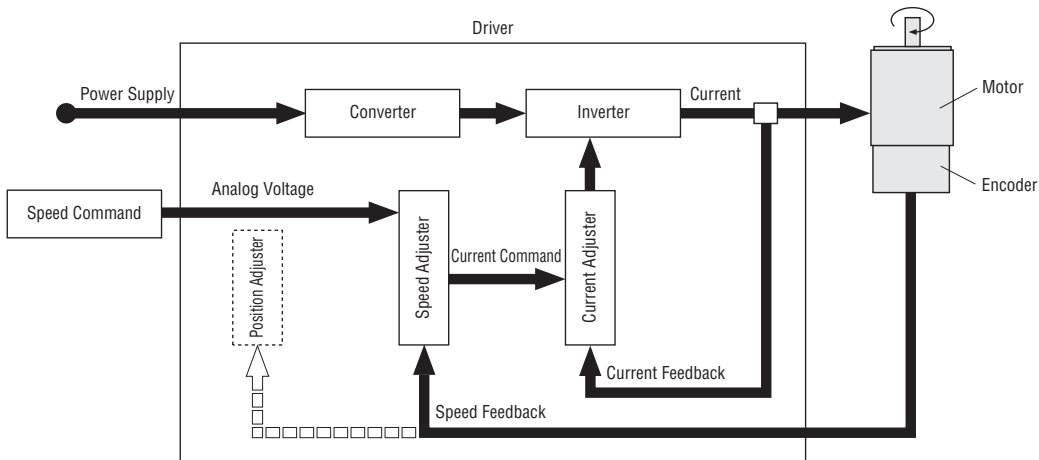

◇ **Torque Control by Analog Voltage**  
The analog voltage is input to control the torque.

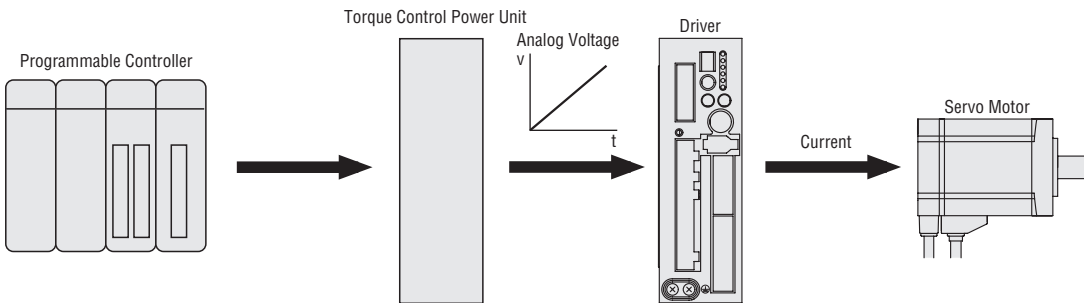

• **Torque Control Diagram**

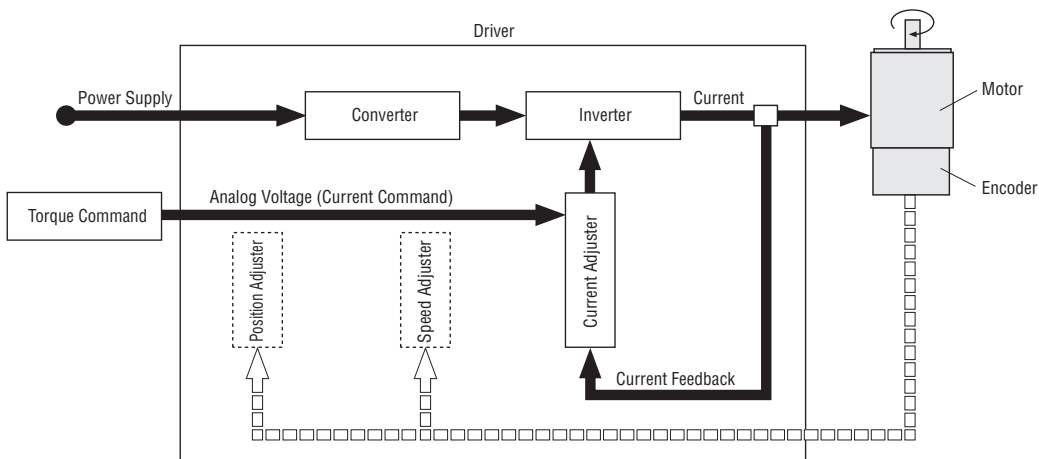

## ● Compact and High Power

The servo motor is compact and lightweight and outputs high power.

## ◇ Speed – Torque Characteristics

Rated Output Power: 200 W (1/4 HP)

Motor Frame Size: 60 mm (2.36 in.)

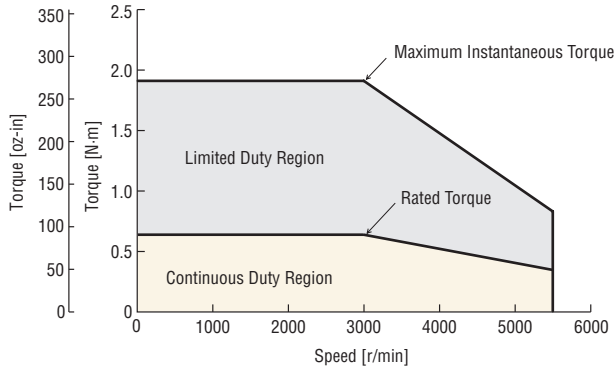

## ● Continuous Duty Region and Limited Duty Region

A servo motor controls the current according to the state of the load. Because of the efficiency and low heat generation of the motor, continuous operation is possible within the rated torque.

Also, during acceleration and deceleration, the limited duty region is used to obtain a large torque, making it possible to decrease the positioning time.

How to Read Speed – Torque Characteristics → Page B-7

## ● A Wide Variable Speed Range

A flat, stable torque is generated from low- to high-speed range, so that long-stroke positioning can be carried out quickly.

The machine cycle is improved in testing equipment by quickly returning at high speed after slowly transporting the workpiece at low speed.

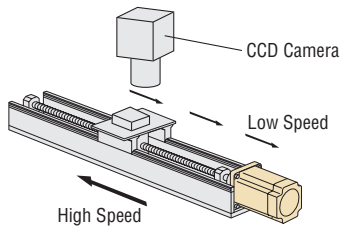

## ● Geared Type also Compatible with Large Inertial Loads

The servo motor has restrictions on the permissible load inertia, but the geared type can be used to greatly increase the load size that can be driven.

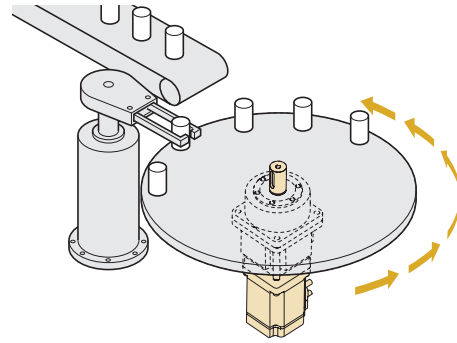

## Motor Types

A wide range of servo motors is available, such as the electromagnetic brake type and geared type in addition to the standard type. Such a wide selection means that you can choose the optimal type according to the function and performance required in your specific application. The **NX** Series incorporates a driver, motor and a cable in one package.

### Standard Type

This is the basic motor round shaft type. Motors are available in a variety of sizes.

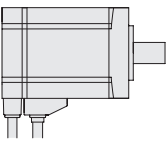

### Geared Type

These motors incorporate a gearhead with reduced backlash to make the most of the high controllability of the motors. The gearhead ensures highly accurate, smooth operation even in applications where a large load torque is received. The inertia of the load converted to the motor shaft is smaller by the square of the gear ratio, improving the start and stop responsiveness.

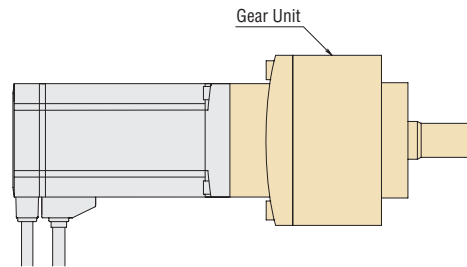
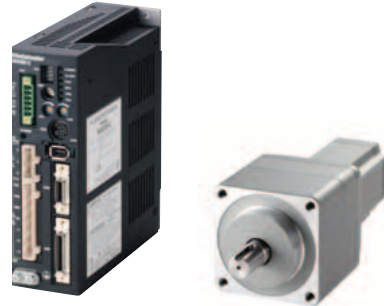

### Electromagnetic Brake Type

These motors incorporate a non-excitation type electromagnetic brake. When the power is accidentally cut off due to a power outage or another unexpected event, the electromagnetic brake holds the load in position to prevent it from dropping or moving. Electromagnetic brake motors are available in a round shaft type or geared type package.

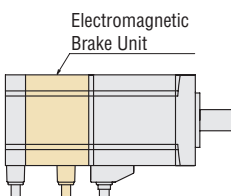
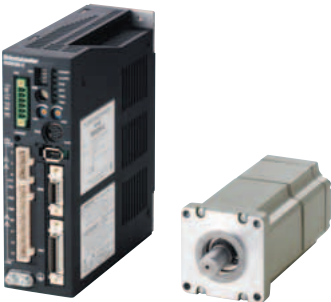

#### ● Regeneration Operation

When suddenly starting or stopping a vertical drive (gravitational operation) or big inertia, the motor goes into regeneration operation, working as a generator. For regeneration operation with the **NX** Series, use the regeneration unit, sold separately. Regeneration Unit → Page B-57



NX Series Regeneration Unit

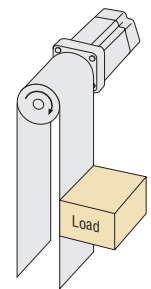

Gravitational Operation

# How to Read Specifications Tables

Model	Standard Type		NX45A-3	NX65A-PS5-3
	Electromagnetic Brake Type		NX45M-3	NX65M-PS5-3
① Rated Output Power		W (HP)	50 (1/15)	50 (1/15)
② Rated Speed		r/min	3000	—
③ Maximum Speed		r/min	5500	—
④ Motor Permissible Speed		r/min	—	3000
⑤ Rated Torque		N·m (oz·in)	0.159 (22)	—
⑥ Maximum Instantaneous Torque		N·m (oz·in)	0.478 (67)	—
⑦ Permissible Torque		N·m (oz·in)	—	0.716 (101)
⑧ Maximum Torque		N·m (oz·in)	—	2.15 (300)
⑨ Permissible Speed Range		r/min	—	0 to 600
⑩ Rotor Inertia		kg·m <sup>2</sup> (oz·in <sup>2</sup> )	0.0174 (0.095)×10 <sup>-4</sup> [0.0217 (0.119)×10 <sup>-4</sup> ]	
⑪ Gearhead Internal Inertia		kg·m <sup>2</sup> (oz·in <sup>2</sup> )	—	0.0431 (0.24)×10 <sup>-4</sup>
⑫ Permissible Load Inertia		kg·m <sup>2</sup> (oz·in <sup>2</sup> )	1.74 (9.5)×10 <sup>-4</sup>	0.0022 (120)
⑬ Gear Ratio			—	5
⑭ Resolution		P/R	100 to 100000 (Factory setting 1000)	
Detector			Absolute Encoder 1 rotation 20 bits, multiple rotation 16 bits	
⑮ Backlash		arc minutes (degrees)	—	15 (0.25°)
Power-Supply Input	Voltage and Frequency	AC Main Power Supply	Single-Phase 100-115 VAC -15% to +10% 50/60 Hz Single-Phase 200-230 VAC -15% to +10% 50/60 Hz Three-Phase 200-230 VAC -15% to +10% 50/60 Hz	
		DC Control Power Supply	24 VDC±10% 0.8 A	
⑯ Rated Input Current A		Single Phase 100-115 VAC	1.9	2.8
		Single Phase 200-230 VAC	1.2	1.8
		Three Phase 200-230 VAC	0.7	1.0
Electromagnetic Brake	Type		Power Off Activated Type	
	Power-Supply Input		24 VDC±10%	
	Power Consumption	W	6.1	
⑰ Static Friction Torque		Excitation Current	A	0.25
		N·m (oz·in)	0.159 (22)	0.716 (101)

## ① Rated Output Power

The range in which the temperature rise does not exceed the permissible value when operating continuously at the motor's rated speed and rated torque.

## ② Rated Speed

The speed when the motor is operating at the rated output power.

## ③ Maximum Speed

The max. speed at which the motor can rotate.

## ④ Motor Permissible Speed

The max. speed at which the geared type motor can rotate.

## ⑤ Rated Torque

The torque output when the motor is operating at the rated output power and rated speed.

## ⑥ Maximum Instantaneous Torque

The maximum torque that can be used instantaneously (for a short period of time). During acceleration and deceleration, the motor can be used up to a max. of this torque.

## ⑦ Permissible Torque

The permissible torque represents the max. value limited by the mechanical strength of the output gear shaft when operated at a constant speed.

## ⑧ Maximum Torque

This is the max. torque value that can be applied to the output gear shaft during acceleration/deceleration such as when an inertial load is started and stopped.

## ⑨ Permissible Speed Range

This is the range for rotation on the output gear shaft.

## ⑩ Rotor Inertia

This refers to the inertia of the rotor inside the motor.

This is necessary when the required torque (acceleration torque) for

the motor is calculated.

## ⑪ Gearhead Internal Inertia

The inertia inside the gearhead. This is necessary when the required torque (acceleration torque) for the motor is calculated.

## ⑫ Permissible Load Inertia

The load inertia at which the motor is stable and can be controlled. If a load exceeding this value is applied, control becomes unstable and speed regulation variance, protective circuit activation, vibration, and other problems occur.

## ⑬ Gear Ratio

This is the ratio in rotation speed between the input speed from the motor and the speed of the output gear shaft. For example, a gear ratio of 10 indicates that when the input speed from the motor is 10 r/min, the output gear shaft speed is 1 r/min.

## ⑭ Resolution

This shows the angle that the motor rotates for 1 pulse.

The motor positioning accuracy is determined by the resolution.

## ⑮ Backlash

This is the play of the output gear shaft when the motor shaft is fixed. When positioning in bi-direction, the positioning accuracy is affected.

## ⑯ Rated Input Current

This is the input current value for the main power supply required when the motor is used in the continuous duty region.

## ⑰ Static Friction Torque

This is an electromagnetic brake specification. This is the max. holding torque (holding force) at which the electromagnetic brake can hold the position.

# How to Read Speed – Torque Characteristics

## NX620AA-3

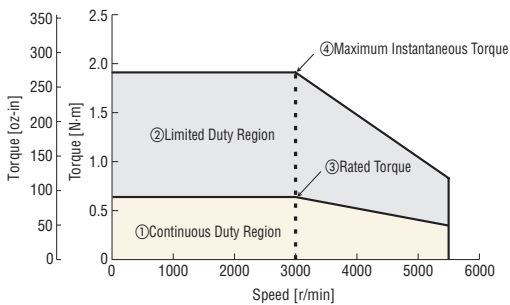

## NX920AA-PS5-3

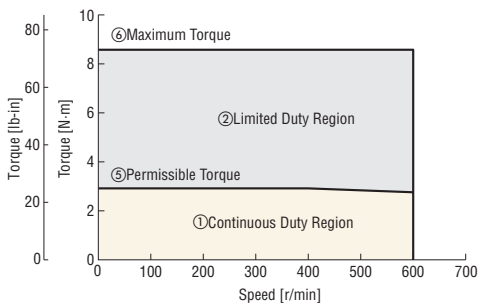

### ① Continuous Duty Region

This refers to the region where a motor can be operated at the continuous ratings. The effective load torque must always be kept in this region.

### ② Limited Duty Region

This region is used when accelerating/decelerating.

### ③ Rated Torque

The torque output when the motor is operating at the rated output power and rated speed.

### ④ Maximum Instantaneous Torque

The maximum torque that can be used instantaneously (for a short period of time). During acceleration and deceleration, the motor can be used up to a max. of this torque.

### ⑤ Permissible Torque

The permissible torque represents the max. value limited by the mechanical strength of the output gear shaft when operated at a constant speed.

### ⑥ Maximum Torque

This is the max. torque value that can be applied to the output gear shaft during acceleration/deceleration such as when an inertial load is started and stopped.



